

# ORECK<sup>®</sup> XL<sub>|||||</sub><sup>®</sup>

SIMPLY AMAZING<sup>®</sup>

USER'S GUIDE

## Compact Canister Vacuum

Models  
BB870-ED  
BB870-QD  
BB870-EW

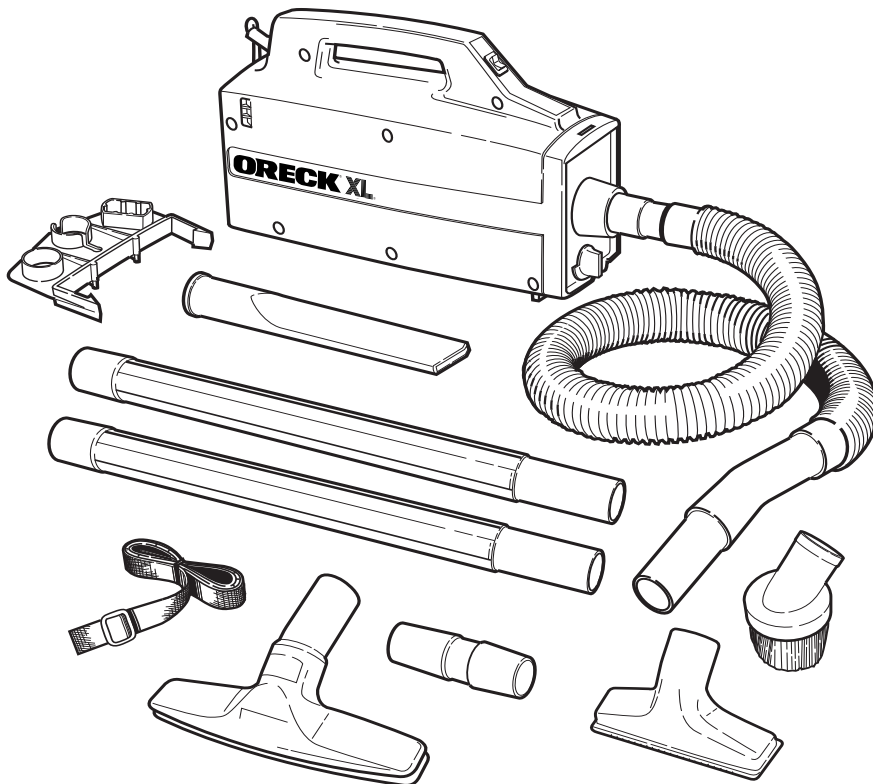

• **IMPORTANT!**  
**SAVE THIS BOOKLET!**

Includes:

- Safety Warnings
- Parts List
- Operating Instructions
- Accessories List
- Warranty
- Trouble Diagnosis

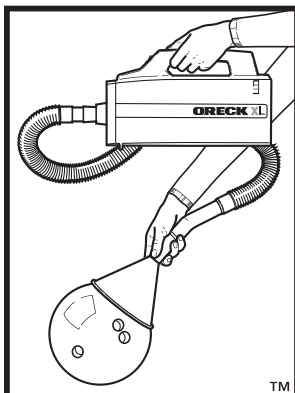

**STRONG ENOUGH TO PICK UP  
A 16-LB BOWLING BALL.<sup>™</sup>**

# BEFORE OPERATING CLEANER, READ ALL INSTRUCTIONS IN THIS MANUAL CAREFULLY.

## *Table of Contents*

Maintenance and Customer Service, Important Electrical Information, Important Safety Instructions .....	page	2
To Operate, Maintenance, .....	page	3
Warranty, Safeguards, Accessories, Troubleshooting Guide, Parts Included, .....	page	4

## *Maintenance and Customer Service*

Your Oreck Compact Vacuum Cleaner is a product of precise engineering. The motor bearings are permanently lubricated and should not be oiled. If you require additional information or have problems with your Oreck appliance, you may call ORECK customer service at: **0845 603 0153**.

Or write to:

**Oreck UK**  
**P.O. Box 107**  
**Exeter**  
**Devon**  
**EX2 8ZQ**  
**Attention: Oreck Customer Service**

Please specify the model number and serial/code number which can be found on the data plate on the back of the vacuum.

Save your sales or purchase slip. Should your Oreck appliance require warranty service, present this slip to the Authorized Service Center as your proof of purchase date.

## *Important Electrical Information*

The wires in the main lead are coloured in accordance with the following code:

**Blue - Neutral    Brown - Live**

If the colours of the wires in the main lead of this appliance do not correspond with the coloured markings identifying the terminals in your plug, proceed as follows:

The wire which is coloured blue must be connected to the terminal marked with the letter **N** or coloured black. The wire coloured brown must be connected to the terminal marked with the letter **L** or coloured red. **Do not make any connection to the terminal marked E or  $\perp$  or coloured green and yellow.**

This appliance is double insulated and no earth connection is necessary.

 If you remove the plug from power supply cord, dispose of it. A shock hazard could result if incorrect plug is inserted into a 13 AMP socket outlet.

**When changing fuse, use 5 AMP or same size replacement fuse.**

Never use the plug without the fuse cover fitted in place.

The fuse carrier is red and hinged to the plug. Do not use the plug if it is different.

If necessary, you may contact customer service for replacement fuse covers.

**MOTOR PROTECTION SYSTEM:** If fine materials such as soot, cement, plaster dust, copy machine powder, etc. are picked up, the bag surface may seal and cause the motor to shut off to avoid over-heating. If this happens, turn the switch off and unplug the cleaner. Replace filter bag. Check and clear any clogs in hose or accessories. After approximately 30 min. the motor will have cooled and the cleaner will be ready to use.

**Note: The cleaner must remain unplugged for 30 minutes for motor to cool and system to reset.**

# IMPORTANT SAFETY INSTRUCTIONS

When using an electrical appliance, basic precautions should always be followed, including the following:

READ ALL INSTRUCTIONS BEFORE  
USING THIS VACUUM CLEANER



## WARNING

To reduce the risk of fire,  
electric shock, or injury:

- Do not leave appliance unattended when plugged in. Unplug from outlet when not in use and before servicing.
- Do not use outdoors or on wet surfaces.
- Do not allow to be used as a toy. Close attention is necessary when used by or near children.
- Use only as described in this manual.
- Do not use with damaged cord or plug. If appliance is not working as it should, has been dropped, damaged, left outdoors, or dropped into water, return it to a service center. Call **0845 603 0153** for the service center nearest you.
- Do not pull or carry by cord, use cord as a handle, close door on cord, or pull cord around sharp edges or corners. Do not run appliance over cord. Keep cord away from heated surfaces.
- Do not unplug by pulling on cord. To unplug, grasp the plug, not the cord.
- Do not handle plug or appliance with wet hands.
- Do not put any object into openings. Do not use with any opening blocked; keep free of dust, lint, hair and anything else that may reduce air flow.
- Keep hair, loose clothing, fingers and all parts of body away from openings and moving parts.
- Do not use to pick up anything that is burning or smoking, such as cigarettes, matches, or hot ashes.
- Do not use without filter bag assembly in place.
- Turn off all controls before unplugging.
- Use extra care when cleaning on stairs.
- Do not use to pick up flammable or combustible liquids, such as gasoline, or use in areas where they may be present.

SAVE THESE INSTRUCTIONS  
**Household Use Only**

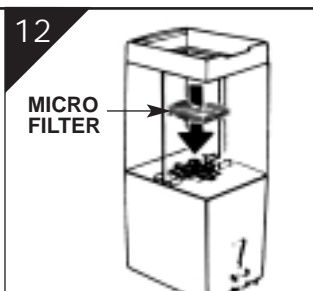
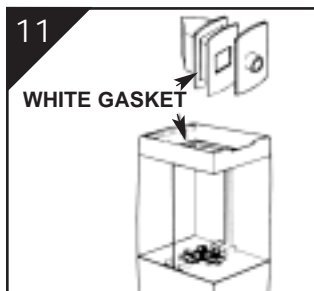
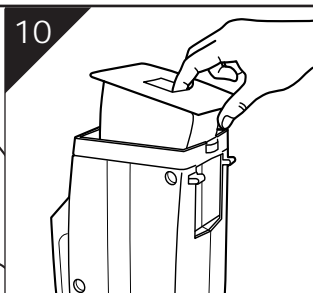
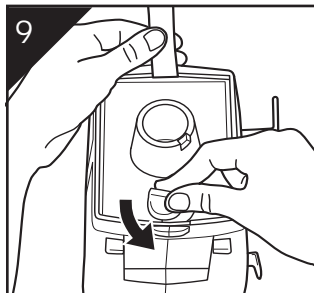
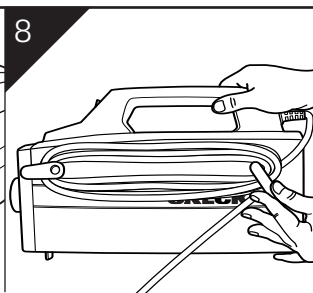
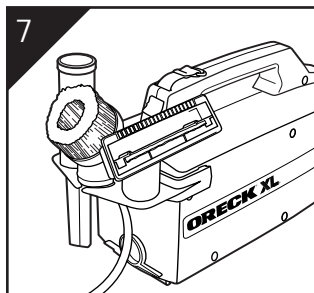
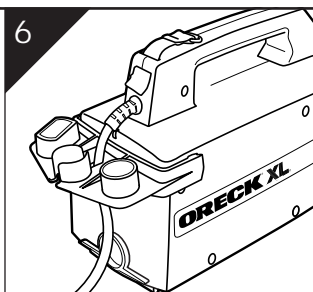
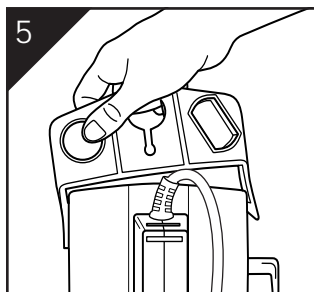
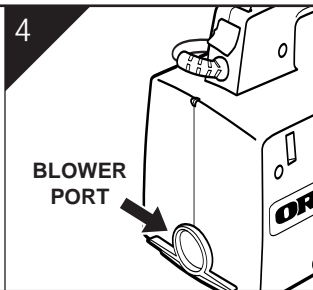
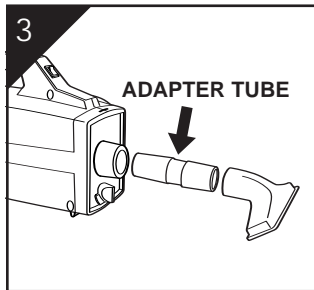
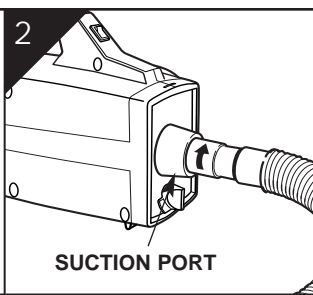
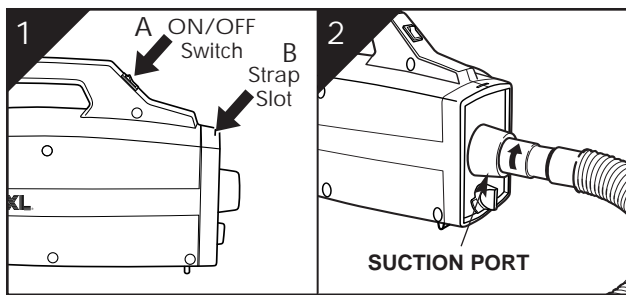

## To Operate

**IMPORTANT: DO NOT REMOVE** the dirt retaining flap attached on the back of the front plate. It must be left in place for the unit to operate properly and to ensure cleaning effectiveness.



Plug cord into electrical outlet.

### Shoulder Strap

**fig. 1a** Insert end of shoulder strap into slot in front of on/off power switch. Pull through three to four inches and insert into plastic clip. One inch of strap must be completely through clip. Insert other end of strap through slot located at back of handle. Insert end into clip and pull through. Adjust length by pulling strap through clip. Strap must go through both front and back clips.

**IMPORTANT:** Before using shoulder strap, pull both ends to be sure it is secure.

### Power Switch

**fig. 1b** Push the power switch located on handle to the "ON" (I) position.

### Hose & Tool Installation

**fig. 2** The flexible hose uses a Shurlock® locking system that prevents hose removal unless intended. To install hose, align "J" slot in hose coupling with tab inside the suction port. Insert hose in port. Twist collar clockwise to lock hose coupling in port. Twist counterclockwise and pull to remove hose.

The extension wands and cleaning tools supplied with your Oreck XL Compact Canister Vacuum lock together with friction. Twist and push to be sure they lock tightly when installing. Twist and pull to remove.

**fig. 3 NOTE:** When installing tools directly to blower or suction port without using hose, tool adapter tube must be used.

### Blower Port

**fig. 4** The blower port is located at the rear of the machine. Installation of tools is the same as described for suction port.

### Attach Caddy and Insert Tools (BB870-ED & BB870-EW)

**fig. 5** Locate caddy clip indents at top rear corners of appliance. Place appliance on firm, nonslip surface or hold in your lap. Grasp handle firmly. Place end of caddy in outside indent then strongly push and pull other end of caddy into opposite indent. Be sure rims on caddy openings face up. Avoid trapping fingers when caddy snaps on; painful pinch could result. If caddy needs to be removed, a large flat-head screwdriver inserted under caddy clip at indent can be used to carefully pry caddy loose.

**fig. 6** Pull cord through center opening in caddy and push until it is seated at back of slot at rear of center opening in caddy.

**fig. 7** Insert crevice tool, brush and fabric tool into caddy in spaces provided.

### Cord Dump (BB870-ED & BB870-EW)

**fig. 8** Twist cord dump to easily release stored cord.

## Maintenance

### Changing the Filter Bag

**fig. 9** Use only genuine Oreck XL filter bags. Stand unit on its back. Twist knob counterclockwise to release front plate. Lift out front plate.

**fig. 10** Remove used bag and insert fresh bag. The cardboard rim fits smoothly into the recessed top.

**fig. 9** Replace the front plate and close unit by turning knob clockwise.

**fig. 11 IMPORTANT:** The white gasket glued in the housing must be in place or unit will not operate properly. Replace if needed.

### Replacing Micro Filter

Stand unit on its back.

**fig. 9** Stand unit on its back. Twist knob and lift out front plate.

**fig. 10** Remove disposable bag.

**fig. 12** Remove old filter from bottom inside unit. Replace with new filter.

## Warranty

ORECK MANUFACTURING COMPANY: (Oreck 21180 Johnson Road; Long Beach, MS, USA 39560 gives you the following warranty for this product only if it was originally purchased for residential use, not resale from Oreck or an Oreck Authorized Retail Dealer.)

Oreck will repair or replace, free of charge, to the original purchaser, any part that is found to be defective in material or workmanship within three (3) years of the date of purchase; ten (10) years on housing. This warranty applies to normal domestic use. Any commercial use of this product will void this warranty.

This warranty does not cover the replacement of expendable or consumable parts such as belts, brushes, bulbs, disposable bags and other parts subject to normal wear unless they are defective in material or workmanship.

This warranty does not apply to any part subjected to accident, abuse, alteration, misuse, damage caused by act of God, the use of voltages other than indicated on the serial number displayed on this product or service of this product by other than Oreck or a participating Factory Authorized Service Center.

Oreck does not authorize any person or representative to assume or grant any other warranty obligation with the sale of this product.

Oreck's warranty is valid only if you retain proof of purchase from Oreck or an Oreck Authorized Retail Dealer for this product. If you purchase this product from any other source, your purchase is "AS IS," which means Oreck grants you no warranty, and that you, not Oreck, assume the entire risk of the quality and performance of this product, including the entire cost of any necessary servicing or repairs of any defects.

This warranty is in addition to your statutory and other legal rights.

Reconditioned units carry a 6 month warranty from date of purchase.

## Safeguards

**WARNING: Unplug cord from electrical outlet before servicing.**

- **IMPORTANT:** Make sure filter bag is in place. Do not operate cleaner without filter bag. Damage to motor may occur.
- Be sure bag gasket is in place. If the white bag gasket is damaged or lost, replace at once.  
(Part No. 72017-02)
- For best results, change disposable filter bag regularly even if it is not completely full. An extremely dirty bag or a bag close to full will affect the suction of the cleaner and can create excessive motor heat that could damage the motor. A good practice is to change filter bag every 30 days even if it is not full.
- Do not pick up moist material or liquids.
- If fine materials such as soot, cement, plaster dust, copy machine powder, etc. are picked up, the bag surface may seal and suction will be reduced. Change bag when this occurs.
- Clean the disposable bag cavity and the outside of the canister with a damp (not wet) cloth.
- **IMPORTANT: DO NOT REMOVE** the dirt retaining flap attached on the back of the front plate. It must be left in place for the unit to operate properly and to ensure cleaning effectiveness.

## Accessories

ITEM	PART #
1. Replacement Treated Filter Bags, 12 pk. with 1 Micro Filter	PKBB12DW
2. Replacement Micro Filter	72005-01
3. Replacement White Bag Gasket	72017-02
4. Oreck Fresh Air® Tabs	AIRTABS

## Troubleshooting Guide

**WARNING: Unplug cord from electrical outlet before servicing**

PROBLEM	POSSIBLE SOURCE	AREAS TO CHECK
<b>CLEANER WILL NOT RUN</b>	Not plugged in properly.	Be sure cleaner is firmly plugged into wall outlet.
	No electricity in wall outlet.	Check electrical source—fuse or circuit breaker.
	Needs Service.	Take to service center or call for nearest service center.
<b>CLEANER DOES NOT PICK UP OR HAS LOW SUCTION</b>	Filter bag is full.	Replace filter bag. See "To Replace Paper Filter Bag."
	Hose / Wand tool is clogged.	Clear obstruction.
	Air leak due to missing or damaged gasket.	Replace Gasket

**ALL OTHER SERVICING SHOULD BE DONE BY AN ORECK AUTHORIZED SERVICE CENTER.**

**CALL CUSTOMER SERVICE HOT LINE  
0845 603 0153**

Whenever calling, please be sure to have your model and serial number from data plate.

## Parts Included

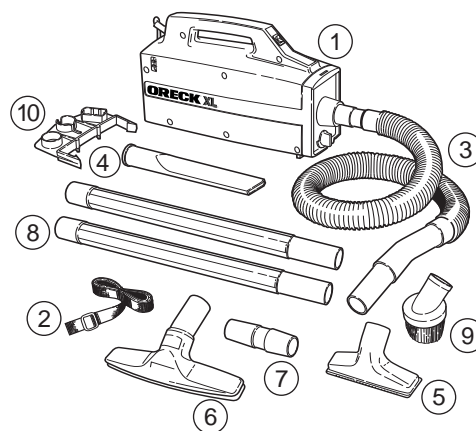

### ITEM

1. Vacuum cleaner housing with paper filter bag and micro filter installed
2. Adjustable shoulder strap
3. Flexible hose with built-in adapter for easy insertion in vacuum or blower port
4. Crevice tool
5. Fabric tool
6. Bare floor and wall tool
7. Tool adapter tube for fitting tools directly to vacuum when not using hose
8. Two extension wands
9. Dusting brush
10. Tool Caddy

## Free Manuals Download Website

<http://myh66.com>

<http://usermanuals.us>

<http://www.somanuals.com>

<http://www.4manuals.cc>

<http://www.manual-lib.com>

<http://www.404manual.com>

<http://www.luxmanual.com>

<http://aubethermostatmanual.com>

Golf course search by state

<http://golfingnear.com>

Email search by domain

<http://emailbydomain.com>

Auto manuals search

<http://auto.somanuals.com>

TV manuals search

<http://tv.somanuals.com>