

User's
Guide

ORECK[®] XL[®]

Cordless Electric Broom

PR8000 Series

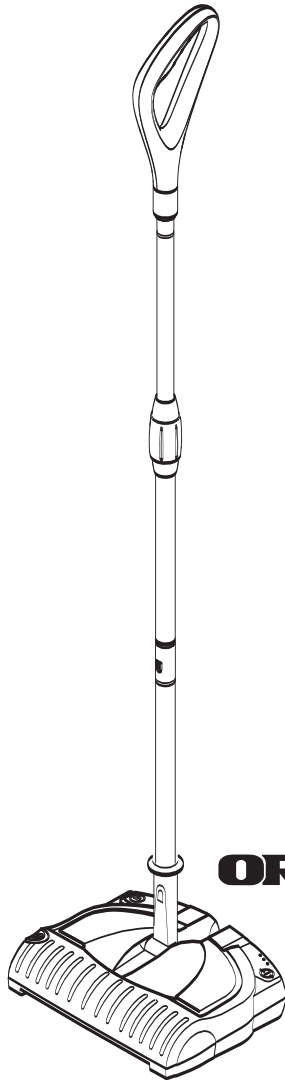

ORECK clean home[™]
HEALTHIER. EASIER. SMARTER.[™]

Important!

Read all instructions carefully, and keep for future reference.

Safety.

General Warnings**IMPORTANT SAFETY INSTRUCTIONS!**

When using an electrical appliance, basic precautions should always be followed, including the following:

READ ALL INSTRUCTIONS BEFORE USING THIS ELECTRIC BROOM**WARNING To reduce the risk of fire, electric shock, or injury:**

- Do not use outdoors or on wet surfaces.
- Use only as described in this manual.
- Do not use with damaged cord or plug. If appliance is not working as it should, has been dropped, damaged, left outdoors, or dropped into water, return it to a service center or call customer service at:
USA: 1-800-989-3535 Canada: 1-888-676-7325
- Do not unplug by pulling on cord. To unplug, grasp the plug, not the cord.
- Do not handle plug or appliance with wet hands.
- Do not put any object into openings. Do not use with any opening blocked; keep free of dust, lint, hair and anything that may reduce air flow.
- Keep hair, loose clothing, fingers and all parts of body away from openings and moving parts.
- Turn off all controls before unplugging.
- Do not use appliance in an enclosed space where oxygen, flammable, explosive or toxic vapors are given off or in an area where flammable dust is present.
- Do not allow to be used as a toy. Close attention is necessary when used by children.
- Do not use extension cords or outlets with inadequate current carrying capacity.
- Do not incinerate or mutilate batteries as they will explode at high temperatures.
- Do not pick up anything that is burning or smoking such as cigarettes, matches or hot material.
- Do not allow the battery to run down completely before charging. In doing so, serious problems may occur in the battery life cycle.
- Do not pick up flammable or combustible liquids such as gasoline or use in areas where they are present.
- Store the adapter indoors in a cool dry area not exposed to the weather to avoid electrical shock and/or cleaner damage.
- Only use the adapter provided by the manufacturer to recharge the appliance.
- Always disconnect cord from electrical outlet before servicing appliance.
- Only charge the unit indoors.

SAVE THESE INSTRUCTIONS
Household Use Only

Contents.

- Assembly** 4
 - Assembly Instructions 4
- Operation** 5
 - Operating Instructions 5
- Maintenance** 5
 - Emptying Dirt Container 5
 - Storage 6
 - Cleaning Standard Carpet Brushroll 6
 - Cleaning Monster Pet Brushroll 6
 - Troubleshooting 7
 - Battery Disposal 7
- Warranty** 8

Operation.

To assist you in identifying your vacuum's components, the parts have been numbered as follows.

Parts List

- 1 Handle
- 2 Telescopic Wand Adjustment
- 3 Monster Pet Brushroll
- 4 Standard Carpet Brushroll
- 5 Detachable Dirt Container
- 6 ON/OFF Switch
- 7 Dirt Container Release
- 8 Charging Socket
- 9 LED Charging Indicator
- 10 Battery Release
- 11 Battery
- 12 Charging Adapter
- 13 Brushroll Release
- 14 Wall Mount Assembly

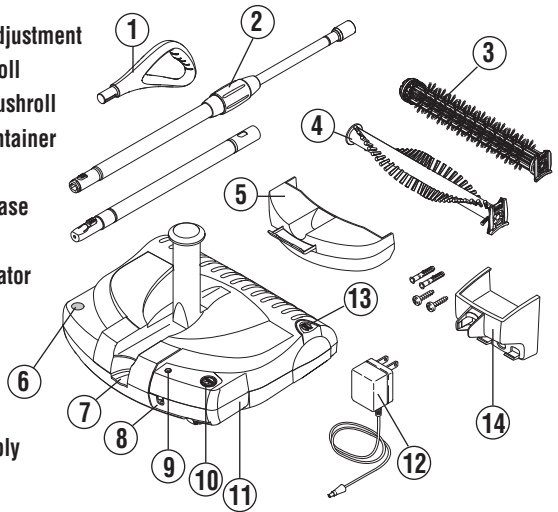

Assembly.

Assembly Instructions

- 1 Attach wall mount to a flat surface using the screws provided.
- 2 Insert the round end of the brushroll against the side-intake. Push the end card of the opposite end of the brushroll into the channel until the end card “snaps” into place.
- 3 Attach handle to the end of strut with the telescopic wand adjustment. Pressing down the locking tab, slide shorter strut over longer strut until locking tab catches. Insert assembled handle into base until it locks in place.

Loosen the telescopic wand adjustment to lengthen or shorten the handle to the desired length and then tighten telescopic wand adjustment.

- 4 Insert battery into battery compartment until it “snaps” in place. Connect the power adapter and allow the unit to charge for 14 hours.

The LED charging display will light when charging. If the LED does not light when charging, check to make sure the unit is in the OFF position.

NOTE: The unit will not charge if left in the ON position.

It is recommended that you remove the power adapter from the unit once the unit has completely charged.

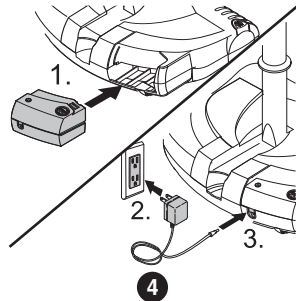
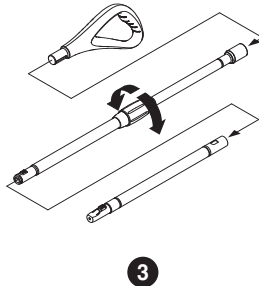
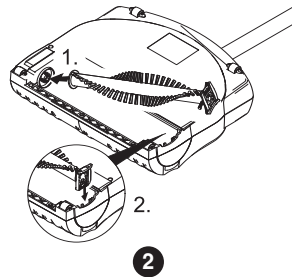
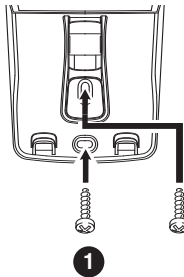

Operation.

Operating Instructions

- 5 Press the ON/OFF switch on top of power head when ready to operate.
- 6 Place foot on power head and lean handle back gently to release lock for vacuum use. Return handle to the full upright position to engage lock.

NOTE: Do not operate the unit while in the upright and locked position. Do not let the unit run while in any one stationary position for any period of time. Keep the unit moving while in operation.

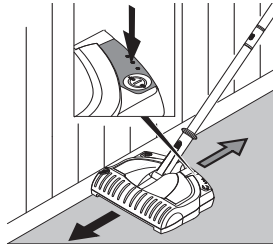

5

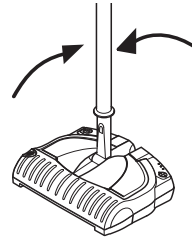

6

Maintenance.

The performance of your new cleaner greatly depends upon care and maintenance. The instructions in this manual will guide you in performing basic care and maintenance. To obtain the most satisfying years of service read the instructions and keep them handy for future reference.

Emptying Dirt Container:

- 7 Firmly grasp the unit at handle base and with the other hand, press the dirt container release. Note: Make sure to have a firm grasp on the handle base and carefully lay the handle flat.
- 8 Lift the dirt container out of the unit and dump contents into wastebasket. Reinsert the dirt container into the unit. Grasp the handle base and carefully rotate it forward until it locks into place.

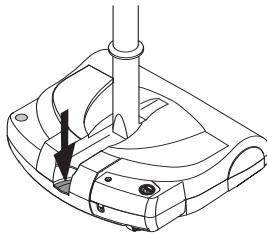

7

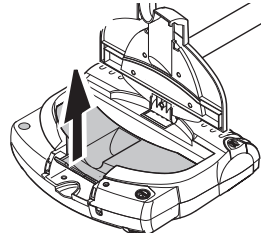

8

Maintenance.

Storage

- 9** Attached the lip of the brushroll chamber over the hooks of the wall mount. Rotate handle upwards until it snaps into the handle lock.

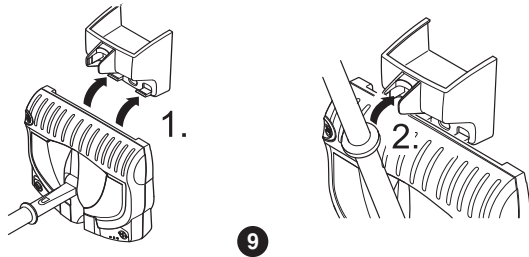

Cleaning Standard Carpet Brushroll

- 10** Press the Brushroll Release to remove the brushroll from the brushroll chamber. Remove any wound up debris using a knife or scissors. Cut debris along patented cleaning grooves in the brushroll for easier cleaning. Reinstall brushroll into brushroll chamber.

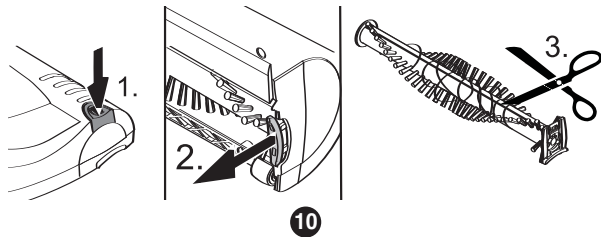

Cleaning Monster Pet Brushroll

- 11** Press the Brushroll Release to remove the brushroll from the brushroll chamber. Pull the round end of the brushroll to remove it from the cleaning cover. All debris to be discarded will be left on the brushroll cover. Remove any wound up debris using a knife or scissors. After cleaning brushroll, insert it back into the cleaning cover. Reinstall brushroll into brushroll chamber.

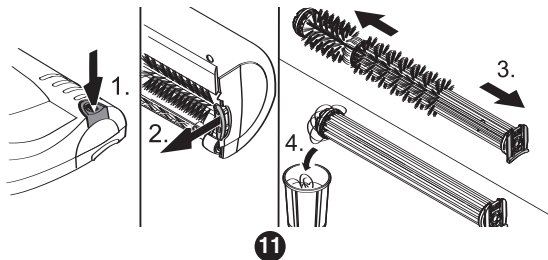

Maintenance.

Troubleshooting

Service problems that appear to be major can often be solved easily. You can be your own troubleshooter by reviewing this guide. **All other servicing should be done by an Oreck authorized service center.**

Problem	What to do
Unit does not turn on.	<ul style="list-style-type: none"> • Charge battery again. • Check electrical source - fuse or circuit breaker.
LED charging indicator not lit while charging.	<ul style="list-style-type: none"> • Make sure the charging adapter is plugged in the electrical outlet and charging socket properly. • Make sure unit is in the OFF position • Check electrical source - fuse or circuit breaker.
Suction power is not sufficient.	<ul style="list-style-type: none"> • Empty dirt container. • Charge battery again • New battery may be required, contact an Authorized Service Center.
Running time in not sufficient.	<ul style="list-style-type: none"> • Charge battery again. • New battery may be required, contact an Authorized Service
Brushroll does not work while operating.	<ul style="list-style-type: none"> • Clean brushroll. • Contact an Authorized Service Center.
Unit still does not operate properly.	<ul style="list-style-type: none"> • Contact Oreck for service.

Customer Service Hotline

USA: 1-800-989-3535 Canada: 1-888-676-7325

website: www.oreck.com

Battery Disposal

To preserve natural resources, please recycle or dispose of expired battery pack properly.

THIS PRODUCT CONTAINS A NICKEL-CADMIUM BATTERY. IT MUST BE DISPOSED OF PROPERLY. LOCAL, STATE, OR FEDERAL LAWS MAY PROHIBIT DISPOSAL OF NICKEL-CADMIUM BATTERIES IN ORDINARY TRASH. CONSULT YOUR LOCAL WASTE AUTHORITY FOR INFORMATION REGARDING AVAILABLE RECYCLING AND/OR DISPOSAL OPTIONS. FOR DISPOSAL INFORMATION, CALL THE RECHARGEABLE BATTERY RECYCLING CORPORATION AT 1-800-8-BATTERY.

Warranty



ORECK MANUFACTURING COMPANY: (Oreck gives you the following limited warranty for this product only if it was originally purchased for use, not resale, from Oreck or an Oreck Authorized Retail Dealer.)

Oreck will repair or replace, free of charge, to the original purchaser, any part which is found to be defective in material or workmanship within one (1) year of the date of purchase. This limited warranty applies to normal domestic use. Any commercial use of this product will void this limited warranty.

This limited warranty does not cover the replacement of expendable or consumable parts such as belts, brushes, bulbs, batteries and other parts subject to normal wear.

This limited warranty does not apply to any part subjected to accident, abuse, commercial use, alteration, misuse, damage caused by fire or act of God, the use of voltages other than indicated on the serial number plate of this product or service of this product by other than Oreck or an Oreck Factory Authorized Service Center.

Oreck does not authorize any person or representative to assume or grant any other warranty obligation with the sale of this product.

Oreck's limited warranty is valid only if you retain proof of purchase from Oreck or an Oreck Authorized Retail Dealer for this product. If you purchase this product from any other source, your purchase is "AS IS," which means Oreck grants you no warranty, and that you, not Oreck, assume the entire risk of the quality and performance of this product, including the entire cost of any necessary servicing or repairs of any defects.

Oreck's liability for damages to you for any costs whatsoever arising out of this statement of limited warranty shall be limited to the amount paid for this product at the time of original purchase, and Oreck shall not be liable for any direct, indirect, consequential or incidental damages arising out of the use or inability to use this product.

Some states do not allow the exclusion or limitation of incidental or consequential damages, so the above limitation or exclusion may not apply to you.

ALL EXPRESS AND IMPLIED WARRANTIES FOR THIS PRODUCT, INCLUDING IMPLIED WARRANTIES OF MERCHANTABILITY AND FITNESS FOR A PARTICULAR PURPOSE, ARE LIMITED IN DURATION TO THE WARRANTY PERIOD, AND NO WARRANTIES, WHETHER EXPRESS OR IMPLIED, WILL APPLY AFTER THIS PERIOD.

Some states do not allow limitations on the duration of implied warranties, so the above limitation may not apply to you.

This warranty gives you specific legal rights, and you may also have other rights which vary from state to state.

Free Manuals Download Website

<http://myh66.com>

<http://usermanuals.us>

<http://www.somanuals.com>

<http://www.4manuals.cc>

<http://www.manual-lib.com>

<http://www.404manual.com>

<http://www.luxmanual.com>

<http://aubethermostatmanual.com>

Golf course search by state

<http://golfingnear.com>

Email search by domain

<http://emailbydomain.com>

Auto manuals search

<http://auto.somanuals.com>

TV manuals search

<http://tv.somanuals.com>