

Oregon
SCIENTIFIC



ATE-1000

For ages 8 to Adult

Oregon
SCIENTIFIC



Dear customer,

Thank you for choosing the Oregon Scientific AIC-1000.

Designed and engineered with extreme precision, the Oregon Scientific AIC-1000 includes the Oregon Scientific Action Lab 1.0 CD-ROM, which allows you to take digital photos and record cool action movie clips. The Oregon Scientific Action Lab 1.0 CD-ROM provides loads of video and photo fun. You can create your own sports videos with different sound effects and animations. We recommend parents help their children with their Oregon Scientific AIC-1000. This manual is designed using technical information in order to allow you to achieve the best results. Some children may require your guidance setting up, learning and understanding how to use the different aspects of the AIC-1000 and its software.

Your use of the Oregon Scientific Action Lab 1.0 CD-ROM is subject to a License Agreement contained inside the CD.

OREGON SCIENTIFIC and associated trademarks and trade dress are owned by OREGON SCIENTIFIC, Inc.
© 2005 OREGON SCIENTIFIC, Inc. All Rights Reserved.

Oregon Scientific AIC-1000 & Action Lab 1.0 CD-ROM

I .	Camera Precautions	1
II .	Technical Specifications	2
III .	Computer System Requirements (Action Lab 1.0)	3
IV .	Camera Description	3
V .	Camera Mounting Description	5
VI .	Quick Start	7
	• Battery Installation	7
	• Turning the camera on/off	8
	• Taking Photos	9
	• Taking Video Footage	10
VII .	Camera Mode Selection	11
VIII .	Downloading Images and Video Clips	14
IX .	TV mode	15
X .	Welcome to Oregon Scientific Action Lab 1.0	16
	• Installing Action Lab	16
	• Working with Action Lab	17
	• Importing Files into My Library from AIC-1000	19
	• Editing Videos	22
	• Exporting Videos	23
XI .	Troubleshooting	25

I) Camera Precautions

Notice the following guidelines when using your camera.

- For your safety, do not press buttons on the camera during sports activities
- Do not place this camera in a damp or dusty location for extended periods of time. This may cause a fire or an electrical shock.
- Do not leave this camera in places subject to extremely high temperatures, such as in direct sunlight for extended periods of time. This may effect the camera case and internal components.
- When the lens is dirty, please clean it with a blower (typically a small device with a rubber bulb attached to one end that you pump to produce a stream of air out the other). If there is a fingerprint or other spot that cannot be removed with a blower, then wipe in a spiraling motion using a soft cloth.
- The working temperature range of a normal AAA battery is 0 - 45°C. Above or below this temperature the functionality of the batteries will be effected.
- Remove the batteries and memory card before storing the camera for long periods of time. Then, keep it in a well-ventilated place in order to prevent molding.
- Under the following circumstances, have the camera repaired by qualified personnel.
 - a) The plug is damaged or worn.
 - b) The device has been dropped and/or the casing has been damaged.
 - c) Liquid has entered the camera.

Although your ATC-1000 is splash-resistant, you should not submerge the camera or expose it to the rain. You should also avoid dropping it, as the camera is not 'shock-proof'. If you want to use your ATC-1000 for watersports, check with your Oregon Scientific dealer about the availability of our waterproof case.

Disclaimer: Oregon Scientific will in no way be responsible for injuries or property damages incurred during participation of any high-risk sport/activity not endorsed or recommended by Oregon Scientific; camera inoperation will not be warrantied except for manufacturing defects.

Notes on copyright: Users are asked to note that the transfer of memory containing photos or data protected under copyright laws is only permissible within the restrictions imposed. Users assume all responsibility in the event that copyrights are violated by the use of this camera.

II) Technical Specifications

- | | |
|-------------------------------|---|
| • Sensor resolution | VGA CMOS, 640 x 480 pixels |
| • Built-in memory | 32MB |
| • SD memory card drive | Supports cards of up to 1 GB (Not included) |
| • Photo storage | 640 x 480 pixels |
| | 320 x 240 pixels |
| | 160 x 120 pixels |
| • Movie storage | 640 x 480 pixels |
| | (15 frames per second) |
| | 320 x 240 pixels |
| | (20 frames per second) |
| | 160 x 120 pixels |
| | (25 frames per second) |
| • Status LCD | 2-digit B/W on top for functions |
| • Focusing | Fixed range from 1.5m~infinity |
| • Self timer | 10 seconds |
| • File format of still images | JPEG |
| • Movie images | AVI |
| • File format of Interface | USB (1.1) |
| • Delete image | All / last one |
| • Auto Shut-Off | 10 minutes |
| • Battery | 4 x AAA Alkaline Batteries |
| • Dimensions | 35mm dim. x 140mm long |
| • Operation system | WIN2000/XP |

III) Computer System Requirements (Action Lab 1.0)

Minimum System Requirements

- Pentium® III 800 MHz or higher
- 256 MB RAM
- 800 MB Free harddisk space
- SVGA 800 x 600 resolution video support (32 bit)
- 16 bit Windows compatible sound device

Recommended System Requirements

- Pentium® IV 2.4 GHz or faster
- 512 MB available RAM
- 1 GB free harddisk space
- SVGA 800 x 600 resolution video support (32 bit)
- 16 bit Windows compatible sound device

IV) Camera Description

1. Lens
2. Microphone
3. Dual-locking grip
4. Handlebar grip
5. Handlebar strap
6. Short Velcro strap
7. Long Velcro strap
8. Instruction Manual
9. Action Lab 1.0 CD-ROM

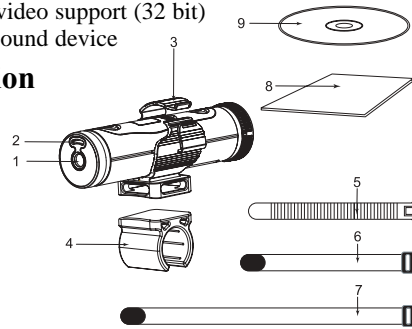

3

10. LCD display
11. Menu button
12. Enter & ON/OFF button
13. Picture shutter release button
14. Movie shutter release button

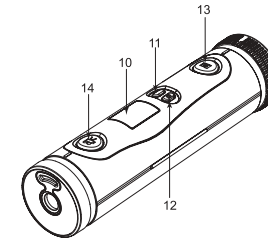

15. Battery tray
16. SD card drive
17. SD card (not included)
18. Mini-USB port
19. USB cable
20. AV port
21. AV cable
22. Release hook
23. Rubberized patch
24. Velcro patch

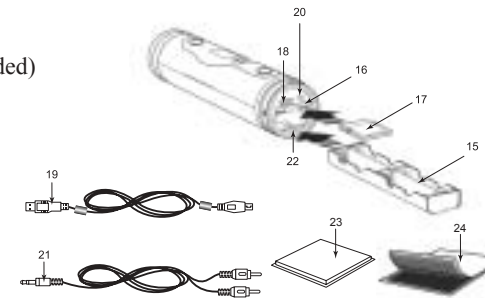

4

V) Camera Mounting Description

The AIC-1000 can be mounted in a variety of different ways using the straps and Velcro patch provided. Please follow the suggested methods of mounting as follows:

To mount AIC-1000 using the handlebar strap:

1. Place the handlebar grip on the handlebar.
2. Place the dual-locking grip on the handlebar grip.
3. Slide the strap through the base of the dual-locking grip and fasten around the handlebar grip.
4. Slide the AIC-1000 into the dual-locking grip. You can adjust the angle of the camera by 10° at a time.

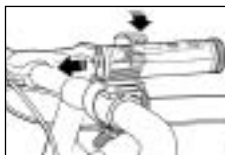

5

To mount AIC-1000 using Velcro straps:

1. Attach the rubberized patch to the underside of the dual-locking grip.
2. Place the dual-locking grip on the helmet, and thread the Velcro strap through its base.
3. Secure the Velcro strap by fastening it through the helmet vents.
4. Slide the AIC-1000 into the dual-locking grip. You can adjust the angle of the camera by 10° at a time.

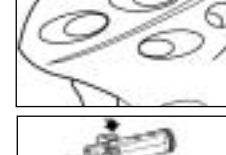

6

VI) Quick Start

Battery Installation

1. Turn and pull to release the cover at the end of the unit.
2. Release the battery tray by pushing the release hook with a pen or similar object.
3. Insert 4 x AAA alkaline batteries into the battery tray with the polarity in the direction as shown.
4. Replace the tray and cover.

Important: When the batteries are low, you will see the low battery icon  on the LCD display.

Always download photos to PC prior to replacing batteries to avoid memory loss.

Note:

- a) Do not mix old and new batteries together. Replace all the batteries at the same time.
- b) Remove the batteries if the camera is not going to be used for some time. This will save battery life.
- c) Do not mix alkaline, standard (carbon-zinc) or rechargeable (nickel-cadmium) batteries.
- d) Battery installation should be done under adult supervision.
- e) Do not get the camera wet.

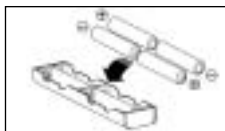

7

Turning the Camera On

For your safety, do not press any buttons on the camera during sports activities.

Method 1

Press the 'On/Off' button for 3 seconds. The LCD display will light up.

Method 2

Plug in the USB cable and connect it to your PC. The camera will then use the USB power source.

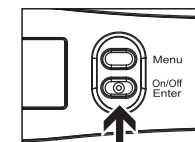

Turning the Camera Off

Method 1

The camera will be turned off automatically after 10 minutes of not being used.

Method 2

Press the 'On/Off' button for 3 seconds. The LCD display will turn off.

Note: If the camera is connected to your PC, you have to unplug the USB cable to turn off the camera.

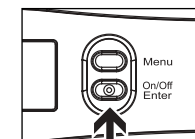
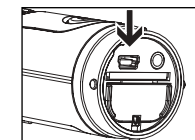

8

Taking Photos

Once the AIC-1000 is turned on:

The frame number shown on the LCD display will indicate how many shots are available for shooting.

1. Aim at the subject that you want to shoot.
2. Press the 'Photo shutter button' to take photos. The remaining number of photos, shown on the LCD display, will decrease by one each time. (Sometimes it will decrease by two if the photo is very densely colored.)
3. The frame number shown on LCD display indicates how many shots are still available before the memory is full. The counter will automatically deduct one after each shot is taken. It is displayed as a count-down.
4. When a photograph is taken, a single short 'beep' will be heard. After the 'beep' sounds, the camera is ready to take another photo.

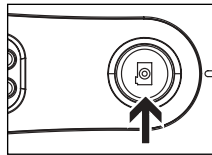

Taking Video Footage

1. Aim at the subject you want to shoot.
2. Press the 'Movie shutter button' to start recording. The time elapsed will be shown on the LCD display.
3. Press the 'Movie shutter button' again to stop recording. The length of the movie clip will show on the LCD display for 3 seconds, after which the remaining time will show. (The remaining time is only an estimate).
4. Press and hold the 'Menu' button for 2 seconds to select the desired resolution (640 x 480, 320 x 240, 160 x 120). Press the 'Menu' button again to cycle through the icons representing these resolutions (at the top of the LCD display), as described on page 12. The icons will flash until you press 'Enter' to confirm your selection.

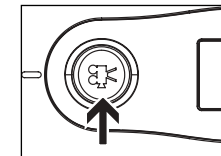

Note:









1. Default resolution is 640 x 480

Note:

1. Default resolution is 640 x 480 (VGA).
2. When the time is shown, you will see 'H' for hour, 'M' for minute and 'S' for second.

VII) Camera Mode Selection

1. You can cycle through different shooting modes by pressing the 'Menu' button repeatedly. The LCD will display each mode as you press the 'Menu' button.
2. Press the 'Enter' button to confirm the selection.
3. When you want to quit the Camera Mode Selection, cycle through the icons by pressing the 'Menu' button repeatedly until the selected icon stops flashing.
4. The different mode icons are shown in the table below.



Icon	Title	Description
	Self timer	10 Second timer
	Continuous shutter	Takes 3 consecutive photos.
	Delete the last picture/clip	Erases the last picture/clip taken
	Delete all photos/footage	Erases all pictures/footage stored in the camera
	High resolution (640 x 480 pixels)	Large photo format/less storage capability
	Medium resolution (320 x 240 pixels)	Medium photo format
	Low resolution (160 x 120 pixels)	Smallest photo format/ more storage capability
	SD card	Shows SD card is being inserted
	Low battery	Battery is low when this icon appears

a) Default 640 x 480 pixels resolution

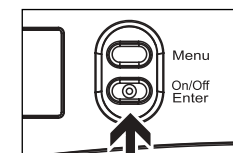
To change the resolution, press the 'Menu' button until the desired resolution icon shows on the LCD display. Press the 'Enter' button to confirm your selection.





b) Continuous Shutter Mode

Continuous shutter mode is activated by selecting  and confirmed by pressing the 'Enter' button. Press the 'Photo shutter' button once to start. The ATC-1000 will take three consecutive photos accompanied by three 'beeps'. To cancel this mode reselect  and press the 'Enter' button.

Note:

1. It doesn't work for taking video footage.
2. This function supports photos (640x480 VGA) only.

c) Self-Timer Mode

Self-timer mode is activated by selecting  and confirmed by pressing the 'Enter' button. Press 'Movie shutter button' or 'Photo shutter button' once to start the countdown. The ATC-1000 will count down 10 'beeps' and then start recording. To cancel this mode reselect  and press the 'Enter' button.

d) Delete the Last Photo/Movie Clip

To delete the last photo/movie clip you shot, press the 'Menu' button until the 'Status LCD' displays . Press the 'Enter' button to confirm. Repeat these two steps to individually delete your files.

Note: After file deletion the LCD display will adjust the remaining number of files accordingly.

e) Delete All Photos/Movie Clips

To delete all photos/movie clips stored in your camera, press the 'Menu' button until the LCD displays . Press the 'Enter' button to confirm.

Note: It may take a few minutes to delete multiple files at one time.

f) Resolution

This camera lets you select from three photo resolutions: 640 x 480, 320 x 240, and 160 x 120 pixels. High resolution photos are better quality because they have more pixels. The lower resolutions have fewer pixels but allow you to take more photos. The number of photos your camera can take depends on the resolution you choose. Since the LCD can only display four digits at a time, SD memory cards with high storage capability will have more photos or time available than the screen can display. In this case, the screen will display "9999" until the number of photos or the amount of time available has decreased enough to be displayed accurately. To switch between high resolution , medium resolution and low resolution , press the 'Menu' button until the 'Status LCD' displays the correct icon. Press the 'Enter' button to confirm your selection.

g) SD Card

To use a SD memory card, turn off the ATC-1000 and insert the SD memory card. When the camera is turned on again the SD card icon will be displayed on the LCD.



The remaining number of photos will also be displayed on the LCD. All the new captured images and video footage will be saved onto the SD card.

Note:

1. If there is an error on the SD memory card, the SD card icon and the letters 'Err' will be displayed on the LCD. In this case, turn off the camera and remove the SD card.
2. The letters 'Err' will be displayed during taking photos or video footage if the SD card is locked.

VIII) Downloading Images and Video Clips

After you've finished taking pictures, connect your camera to your PC using the USB cable. This enables you to download your photos and video footage to PC.

1. A new drive will be found automatically when camera is connected to the computer. This is the ATC-1000 drive.
2. Open the '100IMAGE' folder [in the DCIM folder] to start selecting your desired video or image files.
3. Copy the desired video or image files to your PC.

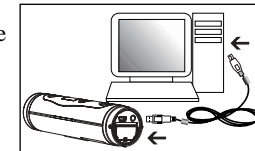





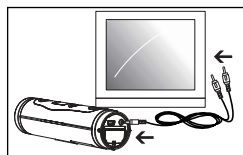

Note:

1. Still images will be saved in JPEG format and movies will be saved in AVI format.
2. When ATC-1000 is connected to the PC when the SD card is in the camera, the '100IMAGE' folder will show the files on the SD card.

IX) TV Mode

After you've taken photos and video footage, connect your camera to your TV using the AV cable to view them with your family and friends. TV mode is automatically activated when the AV cable is connected to the camera.



Once the cable is connected, the function keys will be shown on the TV screen. The function keys include Pause , Stop , Reverse , Play , Forward  and Delete-One .

1. Press the 'Menu' button to move the highlight cursor along the function keys.
2. Press the 'Enter' button when the desired function key is highlighted.
3. To delete one file select  and confirm by pressing the 'Enter' button.

X) Welcome to Oregon Scientific Action Lab 1.0

Action Lab 1.0 is an easy-to-use video editing program. This program is a comprehensive application ideal for organizing, viewing, enhancing, editing and sharing your videos and photos. Action Lab 1.0 is a fast and powerful video editing program that everyone from beginners to professionals can use and enjoy.

Installing Action Lab For Windows:

1. Insert the Action Lab CD into your CD-ROM drive. The software will start running automatically on your system. Follow the instructions on screen.
2. After finalizing the installation of the Action Lab 1.0, complete the installation of Action Lab 1.0 by clicking the 'Close' icon.

Note: If the Auto-run feature on your PC is turned off, you'll have to install the software manually by taking the following steps:

1. Insert the CD into your CD-ROM drive.
2. Click Start > Run.
3. In the Run dialog box, type in D:/Setup.exe (where 'D' is your CD-ROM drive).
4. Click OK.
5. Follow the instructions on screen to complete the installation.

Working with Action Lab

Getting Started

In your computer:

1. Click 'Start'.
2. Select Programs > Oregon Scientific Action Lab 1.0 > Action Lab 1.0. The Action Lab 1.0 main screen will appear on your desktop.*



*As a result of our efforts to continually improve our products, the actual screen displays from the product may differ slightly from the diagrams shown.

Options on the Main Screen:

Command Buttons:

Main Screen

My Library – Lets you open a video clip or photo or stored video clip and image to start editing.

Trim – Trim the video clip you want.

Tools – There are 5 tools including drawing tool, text tool, selection tool, filter effect and image tool.

Animation – Lets you add dynamic animation to your sports movie. There are different categories with 100 animations.

Sound – Lets you add sound effects and background music to your movie. You can record your own sounds to add to your movie.

Film Line – Lets you combine different video clips to create a movie.

Playback button – Lets you play your video clips.

Tips for capturing video:

This camera supports SD cards up to 1GB, which could hold up to 1hr of video. However, we recommend that users keep each individual video clip at around 15 minutes or less, in order to maximize the performance of Action Lab 1.0.

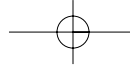

Importing files into Action Lab 1.0 from ATC-1000

In Action Lab 1.0:

1. Click on the 'My Library' button.
2. Click on the 'Import' button to open Windows Explorer.
3. Select the video clip or image you wish to import to 'My Library'.
5. Click the 'Open' button to import.
6. Imported video clips or image thumbnails will appear in 'My Library'.

Tips: Click on the 'Files of type' button in Windows Explorer, and choose Avi or jpg/bmp files.

Note: Please do not import the video clip from ATC1000 directly, because the import time may be long.

Adding Video Clips and Images into the Film Line:

1. In My Library panel, click on a video clip or image with the mouse to highlight it.
2. Click on the 'Add' button to add an image or video clip into the Film Line, double-click the thumbnail for each video clip or image you want to add, or drag the video clip or image to the film line.
3. Click and highlight the desired storyboard file. Click on the 'Add' button to open the storyboard in the Film Line, double-click the thumbnail on the storyboard (project) file you want to open, or drag the storyboard file to the film line to open it.

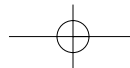

4. Click the 'Close' button to close My Library.

Note: The maximum duration of storyboard is 1 hour.

Delete the clips in the storyboard.

1. Click and highlight the video clip or image in the storyboard.
2. Click the 'Delete' button to remove the selected video clip or image.

Saving a Video

As you work on your storyboard or video, it is recommended that you save the storyboard periodically. Click the 'Save' button, and the contents of the Storyboard will be saved to My Library.

Preview Video Clips

Play the video clips in the storyboard (Film Line).

1. On the Preview screen, press the 'Play' button to preview the video clip.
2. Press the 'Forward' button to play the next frame on the video clip.
3. Press the 'Rewind' button to play the previous frame on the video clip.
4. Press the 'Stop' button to stop playing the video clip.

NOTE: Information about Action Lab 1.0 is for reference only. The program is intended for home use only; for advanced editing, users may export files to other video editing programs.

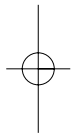

Adding and Deleting Transition Effect between Scenes

Adding the transition effect between scenes can make your movie look more professional.

1. Click the transition button (a small square box) between 2 clips on the storyboard (Film Line). This will open the Transition Effect Panel.
2. Click the transition effect that you want to choose.
3. Click 'Quit' button to close Transition panel.

Trimming a video clip

You can use the trim tool to display any portion of a video clip in your movie by controlling which frame the video starts and stops with. The pointers show you the exact trimming positions.

1. Select the video clip that needs to be trimmed on the Film line (Storyboard).
2. Click the Trim Tool button.
3. On the Trim panel, click and drag either pointer on the timeline to control where the video clips start and finish.
4. To save any changes, click the Trim button.
5. Close the Trim tool by clicking the Cancel button.

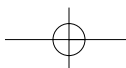
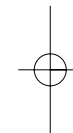
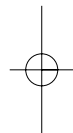
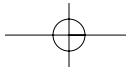

Draw in your Video Clips

You can draw on your video clips using different colors and styles to make your movies more fun.

1. The Drawing Tool panel will open after clicking on the 'Tools' button or the 'Drawing' button.
2. Click the 'Add' button to add a new rectangular bounding box on the Editing/Preview screen.
3. Choose a color from the Color Palette or a style from the Style Palette.
4. Draw by pressing and holding the left mouse button. Draw inside the rectangular bounding box.
5. Adjust the duration of drawing by changing the pointers on the time bar.
6. Only one rectangular bounding box can be added to each video clip.

Adding Animation to your Video Clips

1. Click the 'Animation' button in the Main Commands Panel and the Animation panel will open.
2. Click on a Category button in the panel. The category list will then be visible.
3. Select the animation you want to add. Click the Add button or double-click the name of animation.
4. Change the duration of animation by adjusting the pointers on the time bar.



Adding Background Music

1. Click the Sound Editing button in the Main Command Panel. This will open the Sound Editing panel.
2. Click the Background button. This will open the Background Music panel.
3. Click and highlight the desired background music file name from the list.
4. Click the Play button to listen to the background music before adding it to the video clip.
5. Click the Add button or double click the filename to add the background music to the video clip. The background music icon and the name of the music file will be shown at the upper left-hand of the screen.

Exporting Action Lab files

1. Click on 'My Library'.
2. Open the edited video clip (indicated by a clapper-board icon) in My Library.
3. Click on the 'Export' button on the Film Line (Storyboard)
4. Select the desired location on your PC.
5. Click on the 'Save' button.
6. The edited video clip will be exported to the desired location.

Note:

1. Exported video clips are in AVI format.
2. More content and effects in storyboard, the export time will be longer.
3. The export time is depended on the duration of storyboard. A10 minute storyboard, for example, may take 40 minutes to 1 hour to export.

Create a New Storyboard

1. Click the New Storyboard button to open a new storyboard file in the Film Line. It will clear all previous thumbnails in the Film Line.
2. If the existing storyboard in the Film Line is not saved, it will allow the user to save the file first before closing the storyboard.

Online Updates

To ensure that you are using the latest software version, click on the Update Button . This will help you to make the most of our exciting new features.

Note: If you have a firewall on your PC, the update may be blocked.

Getting Help

Action Lab provides extensive help. If you need more information or instructions on how to use a specific feature or tool, click the 'Help' button  in the upper right-hand corner of the screen.

ATC-1000 Website

Please use the link below to check for the latest software updates, great new features, and exciting new products.

<http://www.oregonscientific.com/atc1000/us>

Troubleshooting

Before contacting an authorized service center at 1-800-853-8883 or sending an email to support@safe-site.net, carry out the following simple checks. They may save you the time of an unnecessary service call.

There's no display

- Are the batteries installed properly?
- Do the batteries need replacing?

After AIC-1000 is connected to my PC, it cannot find the new drive

- Make sure each end of the AIC-1000 USB cable is properly and firmly connected.
- Make sure your USB port is working properly. Try connecting another USB device into the port. If the other device does not work, the USB port may not be working properly. In this case, contact your system manufacturer or the manufacturer of your USB card.

I can't capture video footage or images

- Make sure there is space on the internal memory or on the SD card; the display will tell you how much time is left for video or how many photos you have space for.
- Make sure the SD card is not locked if you have inserted the SD card. The letters "Err" will be displayed if the SD card is locked.

Troubleshooting (continued)

The remaining time is not accurate

- The remaining time is not always accurate because it is only an estimate. The remaining time depends not only on the time recorded, but on the color density of video footage. Under conditions with high contrast, such as outdoors, the actual time available will be less than under low-contrast conditions, such as indoors.

I can't play the video footage on my television

- Make sure each end of the AV cable is properly and firmly connected to AIC-1000 and to your television.
- Make sure the AIC-1000 is turned on.

Some captured video clips or images cannot be found on the SD card

- The video footage or image may be stored on the internal memory. Connect AIC-1000 to your PC without an SD card, and it will show the files in the internal memory .

Further Help

We make every effort to ensure the accuracy and appropriateness of the information provided on our products. However, errors can sometimes occur. We believe it is important for us to stand behind our products and we encourage you to e-mail us at Support@Safe-site.net, or call our Consumer Services Department at 1-800-853-8883 with any problems and/or suggestions that you might have. Our service representatives will be happy to help you.



Oregon Scientific, Inc.

19861 SW 95th Place
Tualatin, OR 97062, USA
Hotline: 1-800-853-8883

Website: www.oregonscientific.com

This device complies with Part 15 of the FCC Rules. Operation is subject to the following two conditions:

(1) this device may not cause harmful interference, and (2) this device must accept any interference received, including interference that may cause undesired operation.

WARNING:

Changes or modifications to this unit not expressly approved by the party responsible for compliance could void the user's authority to operate the equipment.

NOTE:

This equipment has been tested and found to comply with the limits for a Class B digital device, pursuant to Part 15 of the FCC Rules. These limits are designed to provide reasonable protection against harmful interference in a residential installation. This equipment generates, uses, and can radiate radio frequency energy and, if not installed and used in accordance with the instructions, may cause harmful interference to radio communications. However, there is no guarantee that interference will not occur in a particular installation. If this equipment does cause harmful interference to radio or television reception, which can be determined by turning the equipment off and on, the user is encouraged to try to correct the interference by one or more of the following measures:

- Reorient or relocate the receiving antenna.
- Increase the separation between the equipment and receiver.
- Connect the equipment into an outlet on a circuit different from that to which the receiver is connected.
- Consult the dealer or an experienced radio TV technician for help.

"This Class B digital apparatus complies with Canadian ICES-003."

"Cet appareil numérique de la class B est conforme à la norme NMB-003 du Canada"

Free Manuals Download Website

<http://myh66.com>

<http://usermanuals.us>

<http://www.somanuals.com>

<http://www.4manuals.cc>

<http://www.manual-lib.com>

<http://www.404manual.com>

<http://www.luxmanual.com>

<http://aubethermostatmanual.com>

Golf course search by state

<http://golfingnear.com>

Email search by domain

<http://emailbydomain.com>

Auto manuals search

<http://auto.somanuals.com>

TV manuals search

<http://tv.somanuals.com>