

# TRAVEL RADIO-CONTROLLED PROJECTION CLOCK

*MODEL: RM888PA*  
*USER'S MANUAL*

## SECTION 1 INTRODUCTION

Congratulations on your purchasing the RM888PA RF Travel Projection Clock.

The Travel Clock has a slim, compact design i.e. ideal for travel. The RM888PA is designed to automatically synchronize its current time and date when brought within range with the U.S.Atomic Clock.

The Travel Clock has features such as time with alarm on/off status projection, multilingual day-of-the-week display, back-light, dual clock displays (analog and digital), user-selectable default clock display and 8-minute snooze function.

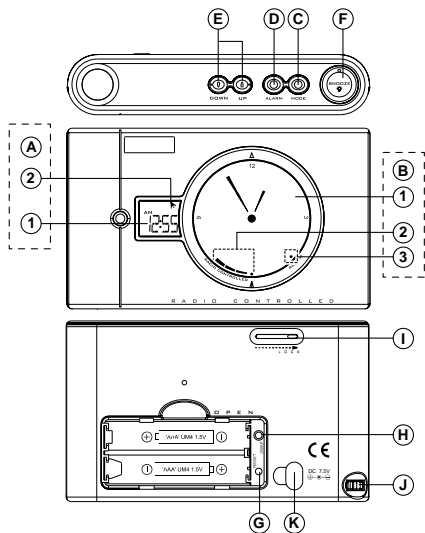

## DISPLAY

### **A. DIGITAL CLOCK DISPLAY**

1. Digital clock display
2. Alarm-on indicator

### **B. ANALOG CLOCK DISPLAY**

1. Analog clock display
2. Radio-reception icon
3. Alarm-on indicator

## CONTROL BUTTONS

### **C. [MODE] BUTTON**

Press to change the display mode or press and hold to enter the setting mode

### **D. [ALARM] BUTTON**

Press to select the daily alarm function or press and hold to enter the setting mode

### **E. [▲] AND [▼] BUTTONS**

Change the value of a setting

### **F. [SNOOZE/☀️] BUTTON**

Press to activate the snooze function or turn on the back-light and projection

### **G. [RESET] BUTTON**

Press to return all settings to default values

### **H. CLOCK DISPLAY [SWAP] BUTTON**

Press to change the default display of the clock

### **I. [LOCK] SLIDE SWITCH**

Locks the key-operation and protects the projection lens while travelling

**J. [FOCUS] KNOB**

Adjusts the focus of projection

**K. 7.5 V DC JACK (with rubber-cover attached)**

For AC power adapter installation

**BEFORE YOU BEGIN**

In order to operate this unit slide the [LOCK] to the left. This will unlock the key-operation and expose the projection lens.

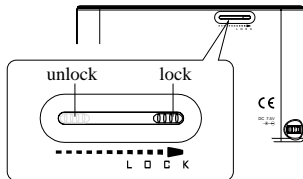
**POWER**

This unit can be either operated by batteries or AC power or with both AC power and batteries.

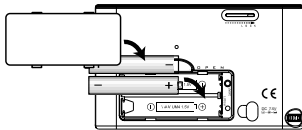
**Battery Installation:**

1. Remove the battery compartment door.
2. Insert two AAA-sized (UM-4) 1.5V batteries as shown.
3. Press **RESET**.
4. Replace the battery compartment door.

When the battery power level is low, the analog clock display will start to blink. Replace the batteries or connect it with AC power adapter and press **RESET**.

This unit is equipped with a short-term power back-up feature. It can still operate for a short period of time even after it has been disconnected from the power supply. Therefore, all settings can be saved during battery replacement. During this period, the analog clock display will also blink. In this case, replace the batteries or connect it with AC power adapter .

**Note:** Under normal circumstances, the batteries are good for 1 year. However, the battery life can be vastly reduced by frequent use of the projector or snooze function.



If not disposed of properly batteries can be harmful. Protect the environment by taking the exhausted batteries to authorized disposal stations.

**HOW TO ACTIVATE THE BACK-LIGHT**

Press [SNOOZE/☀️] to turn on the back-light for 5 seconds.

## HOW TO USE THE PROJECTION

At night-time the projection makes it easy to read the time and the alarm on/off status.

1. Slide the **[LOCK]** slide switch to expose the projection lens.
2. Press **[SNOOZE/☾]** to turn on the projection for 5 seconds. The current time in digital format (as shown in the analog clock display) will be projected onto the surface that the lens is facing. The alarm-on Indicator **[👤]** will also be projected if the Alarm is activated.
3. Adjust the projected image using the **[FOCUS]** knob.

**For continuous projection, plug in the included 7.5 volt DC adaptor.** When the power adapter is connected to the unit, the clock projection will be activated. To keep the clock projection activated press and hold **[SNOOZE/☾]** for 2 seconds. To deactivate the feature, press and hold the snooze button for 2 seconds again or simply remove the power adapter.

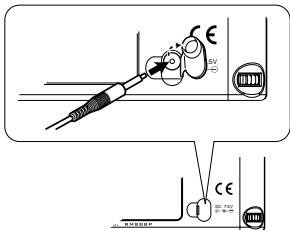

Note: Remember to leave the projection lens uncovered when the continuous projection function is being activated.

When you are not using the clock projection feature, slide the **[LOCK]** switch close in order to protect the lens and lock the keys.

## SECTION 2 THE CALENDAR CLOCK

### DEFAULT ANALOG CLOCK DISPLAY

You can select the local time or home time (the radio-controlled time) as the default analog clock display by using **[SWAP]** switch hidden inside the battery compartment. When the local time is selected or shown, the **LOCAL** icon will be displayed.

### DIGITAL DISPLAY MODES

Press **[MODE]** to display the following in sequence:

- Radio-Controlled Clock Time (same as the default analog clock display) or Local Time.
- Day of the week
- Calendar (Month: Day or Day: Month format)
- 2nd time-zone (Local or home time)

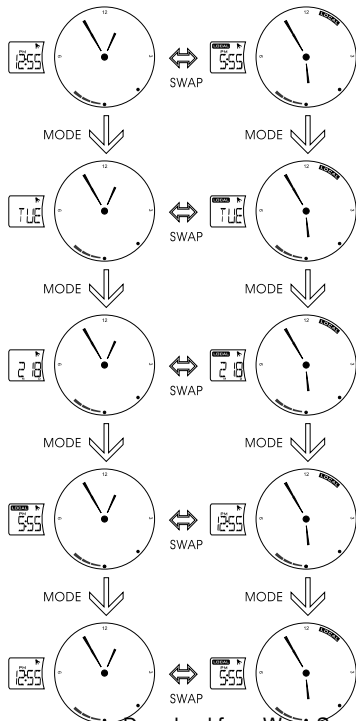

Fig.1

Download from [www.Somanuals.com](http://www.Somanuals.com). All Manuals Search And Download.

### Example of Digital and Analog Display: (Fig.1)

Home-time (Radio-controlled time)

- 12:55pm (12:55)

Local-time

- 5:55pm (17:55)

(hour offset = +5 hours)

To display the alarm clock and details, press [ALARM]. The daily alarm time will appear in both the analog and the digital displays.

Example:

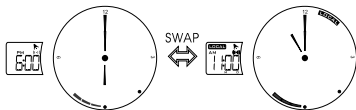

## ABOUT RADIO RECEPTION

The RM888PA will automatically synchronize current time and date with the signal broadcast by the US Atomic Clock when the product is in reception range of the signal. When the unit is new and just out of the box, synchronization with the U.S. atomic clock can take upto 72 hours. The unit will receive the most dependable and interference free signal automatically between Midnight and 4 AM.

When the unit is within range of radio signals, its radio-control mechanism will override all manual settings unless the signal reception is manually deactivated.

When it is receiving radio signal, the radio-reception icon [📶] (strong signal) or [📶] (weak signal) will start to blink. A complete reception generally takes about 2 to 10 minutes, depending on the strength of the radio signal. After that, the periodical scanning will take only a few seconds.

When the reception is complete, the radio-reception icon will stop blinking and the radio-controlled time will be displayed accordingly.

Icon [📶] will be displayed if such reception is not successful. To enforce such reception again, press and hold [▲] for 2 seconds.

For better reception of radio signals, place the clock away from metal objects and electrical appliances to minimize interference.

## HOW TO ENABLE OR DISABLE AUTO-RECEPTION

If you wish to disable radio signal auto-reception while the unit is within range, press and hold [▼] button for 2 seconds. The radio-reception icon on the analog clock display will disappear and the unit will NOT respond to radio signals.

To enable the feature again, press and hold [▲] for 2 seconds. The radio-reception icon will be shown again and the analog clock display will start blinking to initiate radio signal reception.

## HOW TO SET THE CALENDAR CLOCK MANUALLY

1. Press and hold [MODE] for 2 seconds.
2. Enter the U.S. time-zone (Pacific [PAC], Mountain [MOUN], Central [CENT] or Eastern [EAS]) using [▲]/[▼].

3. Press [MODE].
4. Enter the clock format using [▲]/[▼]. You can select 12-hour or 24-hour display.
5. Press [MODE].
6. Enter the hours using [▲]/[▼]. Hold down either button for 2 seconds to rapidly increase or decrease the value.
7. Press [MODE].
8. Enter the minutes using [▲]/[▼].
9. Press [MODE].
10. Set the 2nd time-zone off-set hour by entering the hour difference between the local time and home time. You can select between + 23 and - 23 hours.
11. Follow the same pattern to set the year, date format (month-day or day-month), month, day, and display language (English [E], German [D], French [F], Italian [I] or Spanish [S]) for day-of-the-week.

	E	F	D	I	S
Monday	MON	LUN	MON	LUN	LUN
Tuesday	TUE	MAR	DIE	MAR	MAR
Wednesday	WED	MER	MIT	MER	MIE
Thursday	THR	JEU	DON	GIO	JUE
Friday	FRI	VEN	FRE	VEN	VIE
Saturday	SAT	SAM	SAM	SAB	SAB
Sunday	SUN	DIM	SON	DOM	DOM

12. Press **[MODE]** to save the changes and exit. If changes are made during the process, the seconds will reset and start from zero.

The unit will also save all changes and return to normal display automatically after the unit has been left idle for a minute or when **[ALARM]** is pressed.

---

## ABOUT THE ALARM

---

To set the alarm,

1. Press **[ALARM]** to enter the Alarm mode.
2. Press and hold **[ALARM]** for 2 seconds.
3. Use **[▲]/[▼]** to enter the hours.
4. Press **[ALARM]**.
5. Use **[▲]/[▼]** to enter the minutes.
6. Press **[ALARM]**.

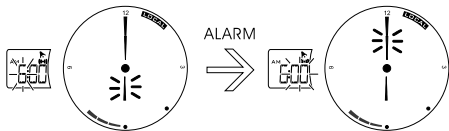

The alarm will be automatically activated. The  icon will appear on the digital display and the Alarm-on icon will be displayed on the analog display. To deactivate the alarm, press **[▲]/[▼]** when the alarm time is displayed.

---

## HOW TO USE THE DAILY ALARM

---

The alarm will go off for 2 minutes in a two-step crescendo pattern. The alarm-on indicators will flash, the back-light and the clock projection will be activated for 5 seconds. To mute the alarm, press any key. Pressing **[SNOOZE/☀️]** will activate the snooze function.

---

## SNOOZE FUNCTION

---

When the snooze function is activated, the alarm will be muted temporarily and set off again after 8 minutes. To disable the snooze function, press **[ALARM]**.

## SECTION 3

### ADDITIONAL INFORMATION

---

## THE RESET BUTTON

---

The **[RESET]** button is used to enhance synchronization of signals after battery replacement or when the unit is operating in an unfavorable way or malfunctioning. Use a blunt stylus to hold down the button. All settings will return to their default values.

---

## PRECAUTIONS

---

This product is engineered to give you years of satisfactory service if you handle it carefully. Here are a few precautions:

1. Do not immerse the unit in water.
2. Do not clean the unit with abrasive or corrosive materials. They may scratch the plastic parts and corrode the electronic circuit.
3. Do not subject the unit to excessive force, shock, dust, temperature or humidity, which may result in malfunction, shorter electronic life span, damaged battery and distorted parts.
4. Do not tamper with the unit's internal components. Doing so will invalidate the warranty on the unit and may cause unnecessary damage. The unit contains no user-serviceable parts.
5. Only use fresh batteries as specified in the user's manual. Do not mix new and old batteries as the old ones may leak.
6. Always read the user's manual thoroughly before operating the unit.

---

## SPECIFICATIONS

---

Power	: 2 pcs of UM-4 or AAA-size 1.5V batteries
Power Adapter (Optional)	: 7.5V DC
Weight	: 2.75 oz.( 78g )
Dimensions (mm)	: 3.94" x 2.36" x.79" (100 x 60 x 20 mm)
Accessory	: Leather pouch for carrying

**Company Name: Oregon Scientific, Inc.**

**Address: 19861 SW 95th Place, Tualatin, Oregon 97062, USA**

**Website address: [www.oregonscientific.com](http://www.oregonscientific.com)**

## CUSTOMER ASSISTANCE

Should you require assistance regarding this product and its operation, please contact our customer care department at 800-853-8883 or via email at [helpme@oscientific.com](mailto:helpme@oscientific.com).

## WARRANTY

This product is warranted to be free of manufacturing defects for a period of 3 months from date of retail purchase. Defective product should be directed to the place of retail purchase for exchange. Should this not be possible, contact our customer care department for assistance and a return material authorization. No returns may be made without a return authorization. Please retain your retail receipt as you may be asked to provide a copy of it for proof of date purchased.

This warranty does not cover product subjected to abuse, misuse, accidental damage or tampering.

### CAUTION

- The content of this manual is subject to change without further notice.
- Due to printing limitation, the displays shown in this manual may differ from the actual display.
- The contents of this manual may not be reproduced without the permission of the manufacturer.



## Free Manuals Download Website

<http://myh66.com>

<http://usermanuals.us>

<http://www.somanuals.com>

<http://www.4manuals.cc>

<http://www.manual-lib.com>

<http://www.404manual.com>

<http://www.luxmanual.com>

<http://aubethermostatmanual.com>

Golf course search by state

<http://golfingnear.com>

Email search by domain

<http://emailbydomain.com>

Auto manuals search

<http://auto.somanuals.com>

TV manuals search

<http://tv.somanuals.com>