

# Fitness Trainer

MODEL: SE332

## USER MANUAL

EN

### CONTROL BUTTONS / LCD DISPLAY

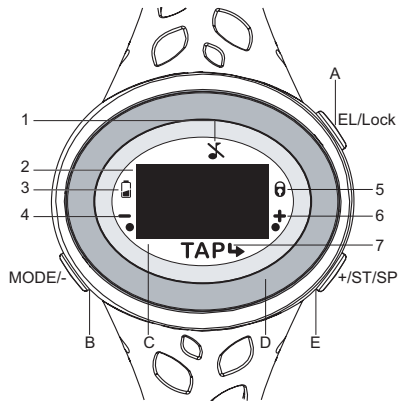

- Key tone deactivated
- Time; heart rate measurements; mode banners; exercise time / data
- Low battery indicator
- Key press prompt (press **MODE/-**)
- Keypad locked
- Key press prompt (press **+/ST/SP**)
- Key press prompt (Tap on lens): **TAP** enter sub setting mode; **TAP** confirm setting

- EL/LOCK:** Activate backlight; lock / unlock keypad
- MODE/-:** toggle between modes; exit current display and return to previous screen; initiate search for HR signal; decrease value of the setting; toggle setting options
- Tap on lens:** enter setting mode; confirm setting; toggle through displays
- Bezel: touch to measure heart rate
- +/ST/SP:** start / stop stopwatch; increase value of the setting; toggle setting options

### STARTING YOUR WATCH (FIRST TIME)

Press and hold any key to activate the LCD screen. The watch will prompt you to set your user profile. (Go directly to 'Set user profile' section, step 4).

#### IMPORTANT

- To ensure accurate calculations with your exercise, you are strongly encouraged to set the watch and user profiles before exercising.
- Remember to set the profiles after every battery replacement or reset.

**NOTE** When the watch is left idle for 30 seconds during set up, it will automatically exit the setting mode and display the time.

### NAVIGATING THROUGH THE OPTIONS

#### KEY PRESS PROMPTS

The watch has been designed with prompts to guide you through the settings and displays.

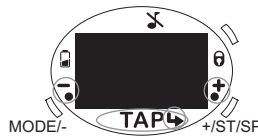

#### TAP ON LENS

The tap on lens feature allows you to toggle through real time fitness data while you are exercising; review stored data of an entire work-out session (memory mode) as well as navigate through the settings (setting mode).

To use the **tap on lens:** Simply tap on the lens.

#### MODES

There are 4 modes. Press **MODE/-** to toggle through the different modes.

MODE	BANNER	MAIN DISPLAY
Time (Default display)	<b>.TIME</b>	A 12:38
Exercise	<b>.EXE</b>	00:00:00

Memory	<b>.MEM</b>	12 DEC 12:28
Set up	<b>.SET</b>	<b>.TIME</b> TAP

### SET USER PROFILE

When prompted to set user profile after starting the watch for the first time, the screen below will be shown. Go directly to step 4.



#### For normal setting procedure:

- Press **MODE/-** repeatedly to select "SET", "TIME" will be displayed shortly after.
- Press **+/ST/SP** repeatedly to navigate to "USER".
- Tap on lens** to enter user profile setting options.
- Set user profile according to the following order: gender, age, weight unit, weight, height unit, height, fitness level, by pressing the following buttons:
  - +/ST/SP** to increase value or toggle options
  - MODE/-** to decrease value or toggle options
  - Tap on lens** to confirm

"DONE" indicates user profile setting has been completed. This is only shown when setting the watch for the first time or after battery reset.

### FITNESS LEVEL

The fitness level is based on your own self-assessment of how fit you are (depending on the amount of exercise you regularly perform).

FITNESS LEVEL	DESCRIPTION
BEG	Beginner – You do not usually participate in programmed recreation sports or exercise.
INT	Intermediate – You are engaged in modest physical activity (such as golfing, horseback riding, table tennis, calisthenics, bowling, weight lifting or gymnastics) 2-3 times a week, totaling 1 hour per week.
ATH	Athlete – You actively and regularly participate in heavy physical exercise (such as running, jogging, swimming, cycling, or skipping rope) or engage in vigorous aerobic exercise (such as tennis, basketball or handball).

**NOTE** You must enter the fitness level to calculate the calories burned.

**TIP** The watch generates calculations based on the inputted data to show the calories burned and the period exercised at the chosen intensity (target HR zone range) to help you track your progress over time. As you progress, update weight and fitness level to help the watch give you an up-to-date reflection of your physical condition.

### SETTING MODE

After setting your user profile, the "USER" screen below will be shown. You can continue with the other settings by pressing **+/ST/SP** repeatedly (see step 2 below).

However, if the user profile was set for the first time or after battery reset, the watch will automatically return to the default time display. Start with step 1.

- Press **MODE/-** repeatedly to select "SET", "TIME" will be displayed shortly after.
- Press **+/ST/SP** to toggle between settings.

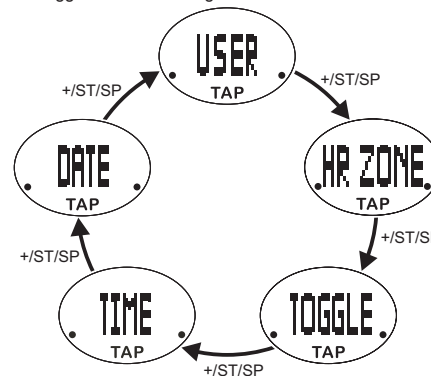

- Tap on lens** to enter into individual setting.
- Start setting the selected option by pressing the following buttons:
  - +/ST/SP** to increase value or toggle options
  - MODE/-** to decrease value or toggle options
  - Tap on lens** to confirm
- Repeat steps 2-4 for all settings.

Settings	Setting options (Press <b>+/ST/SP</b> or <b>MODE/-</b> and Tap to confirm)
TIME	Hour format Hour / minute
DATE	Display format (day-month or month-day) Year Month Day

USER	Gender Age Weight unit Weight Height unit Height Activity level
HR ZONE	On / Off HR Zone range*
TOGGLE	On/Off (Enable display to auto toggle during exercise )

\* For further details please refer to the "Understanding Heart Rate" section in this manual.

### START EXERCISING

- Press **MODE/-** to select "EXE", the stopwatch screen will be displayed shortly after.



- Place finger on metal bezel for a few seconds to measure heart rate.

Heart rate icon will flash to indicate watch is detecting a heart rate reading. A number with bpm indicates measurement has been successful and recorded.



- Press **+/ST/SP** to start stopwatch.

**IMPORTANT** To record calories burned, heart rate must be recorded.

**TIP** If using only stopwatch function, skip step 2 above.

**NOTE** The more frequent you measure your heart rate during the exercise, the more accurate it will be.

To record HR at any time (except in setting mode): place finger on metal bezel for a few seconds.

If you cannot get your heart rate reading within 10 seconds or if any unusual condition occurs during heart rate reading:

- moisten your fingertip
- make sure your fingertip is warm and steady
- do not press too hard on the metallic bezel
- make sure the metallic bezel and the back of your watch are clean

#### NOTE

- Heart rate measurement cannot be activated if keypad is locked or battery power is low.
- Clean the watch with a soft dry cloth.
- The metallic bezel is very sensitive. Accidentally touching it will trigger heart rate measurement. Hence, to prevent from accidentally activating heart rate measurement, you can select to lock the keypad. Alternatively, press any button to exit.

**TIP** You can view the time while exercising. Press **MODE/-** to view time.

### PAUSE, RESUME / STOP

If you need to take a break during exercise, press **+/ST/SP**.

When ready, press **+/ST/SP** to resume exercise.

To stop exercise and save data: Press **+/ST/SP** to pause, then press **MODE/-**.

After a long pause, the watch will time out and automatically save the data.

### UNDERSTANDING THE DISPLAYS

#### NORMAL CONDITIONS

To view total calories burned since last reset: tap on lens when screen shows default time display.

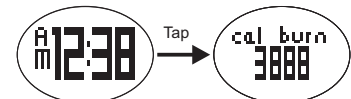

#### DURING EXERCISE

To toggle between displays during exercise: tap on lens.

**TIP** If tap on lens has been enabled (refer to "Setting mode" section), the below 2 screens will automatically toggle.



<b>.01:28:00</b>	Exercise time
<b>.1068 cal</b>	Calories burned (kcal)

## ALERTS

This watch enables you to select a target HR zone according to your fitness goals. By setting the target HR zone and personal data, the watch can monitor how well you do. The watch will send out visual and audible alerts if you are pushing yourself too hard or need to put more effort in.

For details of HR zones, refer to "Understanding heart rate" section in this manual.

If alert has been enabled and heart rate zone has been set:

ICON	BEEP(S)	DESCRIPTION
 / ABOVE ZONE!	2	You have gone above your upper HR limit
 / BELOW ZONE!	1	You have gone below your lower HR limit

Remember, these alerts are based on a calculation of your maximum heart rate and the HR zone you selected. As such, it is an estimation and is only for guidance. If you feel you are working too hard, most likely you are. Adjust the HR zone to one that works for you.

## UNDERSTANDING HEART RATE

### HEART RATE ZONES AND EXERCISE

Heart rate is an indicator of the intensity of the exercise on your body. It is a useful tool for determining how effective a work-out is.

This watch uses an estimation of your maximum heart rate ( $220 - \text{age} = \text{MHR}$ ) to arrive at 5 HR zone settings specific to you.

HR zone settings	Corresponding watch setting	Description / benefit derived	Examples
Fat burning	50% - 60%	For beginners and those with health problems. Gets body used to exercise and improves health.	Brisk walking
	61% - 70%	Improves heart's ability to deliver oxygen. Calories burned mostly from stored body fat.	Jogging, easy cycling.
Aerobic	71% - 80%	Increases endurance and muscle strength. Breathing is faster and deeper promoting proper circulation of oxygenated blood.	Running, aerobic dance, jumping rope.
Anaerobic	81% - 90%	Builds muscle and enhances speed, power and performance levels. Body requires more oxygen than it can provide.	Weight-lifting, resistance machine.
	91% - 100%	For athletes. Vigorous training, usually done in short bursts to enhance power and performance. May increase chance of injury and soreness.	Sprinting

\*The upper and lower heart rate limits are calculated by multiplying your maximum heart rate (MHR) by the percentages.

It is important to pace yourself, especially if you haven't exercised for a while. Start off slow, aiming for the lowest range (50%-60%). As you become more comfortable, challenge yourself by increasing in speed and duration.

To benefit most from your work-out, determine your fitness goal and exercise at a proper intensity. The most common zone range is from 50% to 80% of your maximum heart rate. This is where you achieve cardiovascular benefits, burn fat and become more fit.



Remember, if you rush in too quickly and push your body too hard before it's ready, it can be counterproductive. You can hurt your muscles / tendons and may even result in injury and be a real step back from your goal.



**IMPORTANT** Always warm up before exercise and select the HR zone setting that best suits your physique. Exercise regularly, 20 to 30 minutes per session, three to four times a week for a healthier cardiovascular system.

**WARNING** Determining a suitable exercise intensity is a critical step in the process towards an efficient and safe training program. Please consult your doctor or health professional to help you determine exercise frequency and duration appropriate for your age, condition and specific goals.

## MEMORY

- Press **MODE/-** repeatedly to select "MEM". After 2 seconds, display will show the time and date of the most recent exercise session recorded or "NO RECORD" if there is no data.
- Press **+ST/SP** to navigate to desired record.
- Tap on lens** to toggle through the displays related to selected exercise session.

	Total time taken for entire exercise
	Maximum heart rate

	Average heart rate
	Total calories burned (kcal)

To return to previous screen at any time: Press **MODE/-**.

## CLEAR RECORDS

This watch can contain data for up to 99 exercise sessions. Individual memory cannot be selected and deleted. The watch only allows for all data to be deleted.

### To delete memory:

- Press **MODE/-** repeatedly to select "MEM".
- Press **+ST/SP** repeatedly until "DELETE" will be displayed.
- Press **MODE/-** to confirm.

DONE indicates the record has been cleared.



When starting an exercise and memory is full, "FULL" will be displayed, followed by "DELETE".

- Press **MODE/-** to delete all records
- OR
- Press **+ST/SP** to ignore and start an exercise without recording data for it.

## OTHER OPERATIONS AND SETTINGS

### ACTIVATE BACKLIGHT

Press **EL/LOCK**. (Press any key to extend backlight for another 3 seconds).

**NOTE** The backlight function will not operate if  is displayed.

### BEEP TONE ON / OFF

When time is displayed, press **ST/SP+** to activate / deactivate beep tone.

 indicates beep tone is deactivated.

### REPLACE BATTERY

If the battery power of your watch is low, the watch will display .

### To replace watch battery:

- Use a coin to open the battery compartment lid by turning it anticlockwise.
- Remove the old battery and insert a new CR2032, 3V lithium battery.
- Secure the lid by turning the coin clockwise.

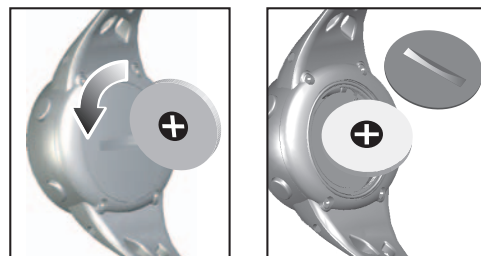

**IMPORTANT** Remember to set the profiles after every battery replacement or reset.





### KEYPAD LOCK

Press and hold **EL/LOCK** to lock or unlock keypad.

 indicates keypad is locked.

## WATER RESISTANCE

The SE332 is water-resistant up to 50 meters (164 feet)

					
	RAIN SPLASHES ETC	SHOWERING (WARM / COOL WATER ONLY)	LIGHT SWIMMING / SHALLOW WATER	SHALLOW DIVING / SURFING / WATER SPORTS	SNORKELING / DEEP WATER DIVING
50M / 164 FT	OK	OK	OK	OK	NO

- Ensure the buttons and battery compartment are secured and intact before exposing the watch to excessive water.
- Avoid pressing the buttons while in the water or during heavy rainstorms, as this may cause water to enter the watch, leading to malfunction.

## SPECIFICATIONS

### CLOCK

Time format	12/24 hour format with hour / minute
Date format	DD.MM.YY or MM.DD.YY

Download from [Www.Somanuals.com](http://Www.Somanuals.com). All Manuals Search And Download.

Year range	2010 - 2059
<b>TRAINING</b>	
Target heart rate zone	50-60%; 61-70%; 71-80%; 81-90%; 91-100%
Maximum memory	99 records
Calorie range	0 to 9,999 kcal
<b>POWER</b>	
Watch	1 x CR2032 3V lithium battery
<b>OPERATING ENVIRONMENT</b>	
Operating temperature	32°F to 104°F
Storage temperature	-4°F to 140°F

## PRECAUTIONS

To ensure you use your product correctly and safely, read these warnings and the entire user manual before using the product:

- Where there is excess electrostatic discharge, the heart rate signal search may be accidentally triggered. Press any button to exit.
- Use a soft, slightly moistened cloth. Do not use abrasive or corrosive cleaning agents, as these may cause damage. Use luke warm water and mild soap to clean the watch and chest belt thoroughly after each training session. Never use the products in hot water or store them when wet.
- Do not bend or stretch the transmitter part of the chest belt.
- Do not subject the product to excessive force, shock, dust, temperature changes, or humidity. Never expose the product to direct sunlight for extended periods. Such treatment may result in malfunction.
- Do not tamper with the internal components. Doing so will terminate the product warranty and may cause damage. The main unit contains no user-serviceable parts.
- Do not scratch hard objects against the LCD display as this may cause damage.
- Take precautions when handling all battery types.
- Remove the batteries whenever you are planning to store the product for a long period of time.
- When replacing batteries, use new batteries as specified in this user manual.
- The product is a precision instrument. Never attempt to take this device apart. Contact the retailer or our customer service department if the product requires servicing.
- Do not touch the exposed electronic circuitry, as there is a danger of electric shock.
- Check all major functions if the device has not been used for a long time. Maintain regular internal testing and cleaning of your device. Have your watch serviced by an approved service center annually.
- When disposing of this product, ensure it is collected separately for special treatment and not as normal household waste.
- Due to printing limitations, the displays shown in this manual may differ from the actual display.
- The contents of this manual may not be reproduced without the permission of the manufacturer.

**NOTE** The technical specifications for this product and the contents of the user manual are subject to change without notice.

**NOTE** Features and accessories will not be available in all countries. For more information, please contact your local retailer.

## ABOUT OREGON SCIENTIFIC

Visit our website ([www.oregonscientific.com](http://www.oregonscientific.com)) to learn more about Oregon Scientific products.

If you're in the US and would like to contact our Customer Care department directly, please visit: [www2.oregonscientific.com/service/support.asp](http://www2.oregonscientific.com/service/support.asp)

For international inquiries, please visit: [www2.oregonscientific.com/about/international.asp](http://www2.oregonscientific.com/about/international.asp)



## Free Manuals Download Website

<http://myh66.com>

<http://usermanuals.us>

<http://www.somanuals.com>

<http://www.4manuals.cc>

<http://www.manual-lib.com>

<http://www.404manual.com>

<http://www.luxmanual.com>

<http://aubethermostatmanual.com>

Golf course search by state

<http://golfingnear.com>

Email search by domain

<http://emailbydomain.com>

Auto manuals search

<http://auto.somanuals.com>

TV manuals search

<http://tv.somanuals.com>