

**COLOUR WEATHER STATION****MODEL: AWS888N****USER'S MANUAL****TABLE OF CONTENTS**

About this guide	2
Product overview	2
Main unit	2
Remote unit	4
Getting started	7
Batteries	7
AC adaptor	7
Remote unit set up	7
Installation	8
Clock	8
Radio signal	8
Remote sensor searching	8
Main unit sensor searching	9
General settings mode	9
Navigating through main menu	9
Changing settings	9
Clock setting	10
Alarm setting	11
Alarm type (daily / weekday)	11
Snooze	11
Weather setting mode	12
Altitude compensation function	12
Clock alarm mode	13
Turning alarm on/off	13

Weather forecast mode	13
Temperature, pressure & hygro mode	14
Barometer display	14
Thermo & hygro memory	14
Clear MIN / MAX records	15
Current thermo-hygro display	15
Auto scan function	15
Comfort zone	15
Trends	15
System setting mode	16
System settings	16
Volume	16
Language	16
Silence mode	16
Auto rotation frequency	16
Sleep mode	16
Auto rotation display mode	16
Clock alarm display mode	17
Reset system	17
Default settings	17
Low battery detection	18
Safety & care	18
Warnings	18
Troubleshooting	19
Specifications	19
About Oregon Scientific	20

ABOUT THIS GUIDE

Congratulations on your selection of the World's first Colour Weather Station (AWS888N) from Oregon Scientific™. This powerful device bundles animated weather forecasting, barometric pressure monitoring, indoor / outdoor wireless temperature and humidity readings, time / date keeping, and dual alarm features into a single tool you can use from the convenience of your home.

Keep this manual handy as you use your new product. It contains practical step-by-step instructions, as well as technical specifications and warnings you should know.

In this box, you will find:

- Main unit
- Remote sensor
- Batteries
- AC adaptor

PRODUCT OVERVIEW

MAIN UNIT

TOP VIEW

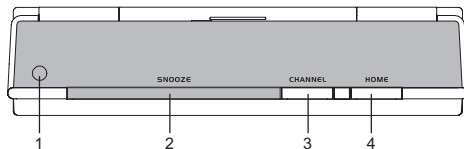

1. Photo Sensor Cell
2. **SNOOZE**
3. **CHANNEL**
4. **HOME** - return to MAIN MENU

NOTE The Photo Sensor Cell can adjust the backlight automatically. In a darker room, the cell will decrease the screen's brightness as to not irritate the user's eye from over-brightness. Conversely, in a brighter room, it increases the brightness of the screen so that it can be seen in bright white light.



FRONT VIEW

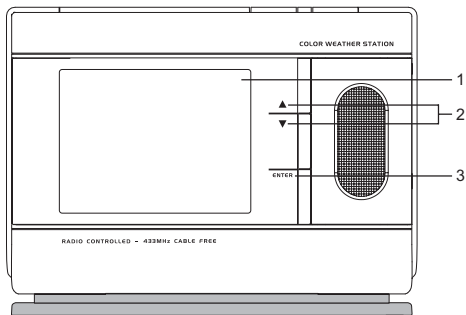

1. Colour display
2. ▲ / ▼ - Increase / decrease setting
3. **ENTER** - select option

BACK VIEW / BATTERY COMPARTMENT

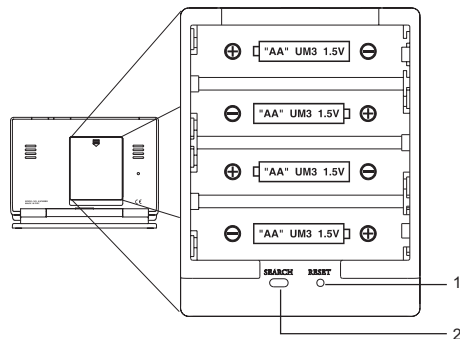

1. **RESET**
2. **SEARCH**

LCD DISPLAY (HOME MENU)

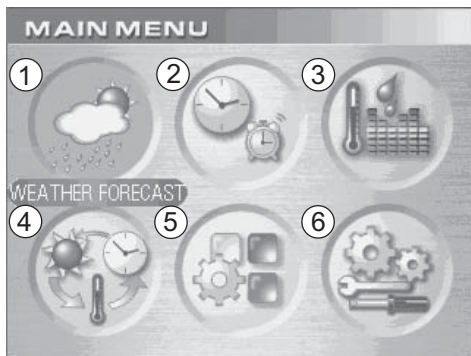

1. Weather Forecast Display Mode
2. Clock & Alarm Display Mode
3. Temperature / Pressure / Hygro Display Mode
4. Auto Rotation Display Mode
5. General Setting Mode
6. System Setting Mode

NOTE Sub menus will be described within the related sections.

REMOTE UNIT (RTGR328N)

This sensor works as an RF clock receiver for this main unit but does not work with previous models. If you want to purchase additional remote sensors, select a model that does not include the RF function such as:

- THGR228N / THGR238N (3-channel sensor)
- THGR328N (5-channel sensor)



FRONT

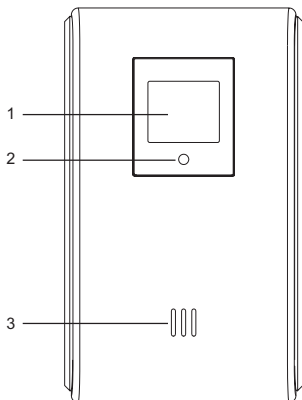

1. LCD display
2. LED status indicator
3. Ventilation duct

LCD

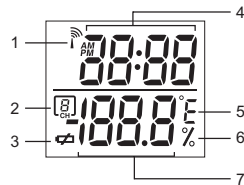

1. RF clock reception
2. Channel no.
3. Low battery indicator
4. Time
5. Temperature (°C or °F)
6. Relative humidity
7. Temperature / Humidity reading

BACK

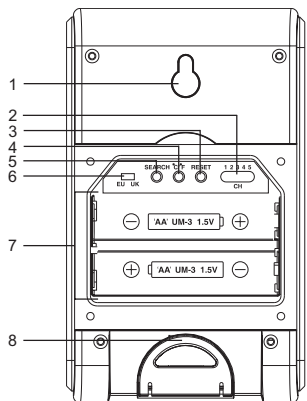

1. Wall mount (recess hole)
2. **CHANNEL** switch
3. **RESET**
4. °C/°F switch
5. **SEARCH** button
6. **EU/UK** radio signal format switch
7. Battery compartment
8. Fold-out stand

FOLD-OUT STAND

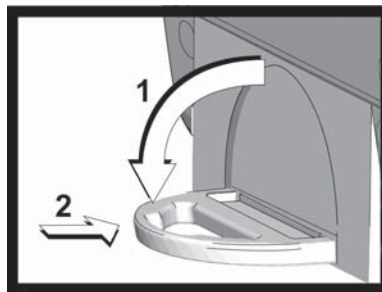

1. Fold-out the stand.
2. Lock it into place.



GETTING STARTED

BATTERIES

Batteries for the remote and main units are supplied with this product. Press the **RESET** button whenever you change batteries.

NOTE Insert the batteries in the remote unit before you set up the main unit. Do not use rechargeable batteries.

AC ADAPTOR (main unit)

When the main unit is plugged into the power socket or batteries are inserted for the first time, an opening animation will be shown before the MAIN menu screen.

DC 4.5V



Connect the AC adaptor to your weather station's AC socket located on the side of the main unit.

NOTE Batteries are for memory backup purposes only; the AC adaptor should power the main unit.

REMOTE UNIT SET UP

Up to 5 remote units can be used with this product to monitor outdoor temperature and humidity. The remote unit included in this package is used to receive radio frequency signals for the radio-controlled clock, and to measure temperature and humidity. The measurement unit (°C or °F) and channel number (1, 2, 3, 4, or 5) switches are located in the battery compartment of the remote unit, and should be set prior to installation.

NOTE Additional remote units that measure temperature and humidity are sold separately. If you are using more than one remote unit, be sure to select a different channel number for each unit.

The following remote units are compatible with this product:

- THGR228N
- THGR238N
- THR228N
- THGR328N

INSTALLATION

Mount the remote unit on a flat surface using the recess holes on the back of the unit.

For best results:

- Insert the batteries and select the measurement unit and channel number first.
- Place the unit out of direct sunlight and moisture.
- Do not place the remote unit more than 50 meters (164 feet) from the main (indoor) unit.
- Position the unit so that it faces the main (indoor) unit. Minimize obstructions such as doors, walls, and furniture.
- To maximize radio frequency reception for the radio-controlled clock, place the remote unit in a location with a clear view to the sky.

You may need to experiment with various locations to get the best reception.

CLOCK

This remote unit can automatically synchronize the date and time with official time-keeping organizations in Frankfurt (Germany) and Rugby (England). When the unit is within 1500 km (932 miles) of a RF signal, the reception icon will blink during reception.



When the remote unit receives the radio-controlled clock signal and is paired up with the main unit, the clock in the main unit will automatically be updated.

RADIO SIGNAL

REMOTE SENSOR SEARCHING

The **RADIO SIGNAL FORMAT** switch is located inside the battery compartment. Select EU (DCF) or UK (MSF). Press **RESET**.

Reception takes 2 - 10 minutes to complete. Once complete, the icon will stop blinking.

Strong signal	Weak signal	No signal
		

Press **SEARCH** to manually activate search for radio-controlled clock signal. The tower icon will blink until the clock signal is found or the search period times out.

NOTE The remote unit collects RF signals. For best results, place it away from metallic or electrical objects, and in a location with a clear view to the sky.



MAIN UNIT SENSOR SEARCHING

Press and hold **SEARCH** for 2 seconds to manually activate sensor searching. The search icon will blink until the remote signal is found or the search period times out.

Search for channel signal (shown in Temp-Hydro-Pressure mode):

Searching for Sensor	Sensor found	No sensor found

Search for RF clock signal (Shown in Clock-Alarm mode). The selected sensor's channel will be shown in the house display window:

Strong clock and remote signal	Weak clock and remote signal	No signal

If no signal is found, check remote unit batteries.

NOTE The sensor search will automatically start when the main unit is reset.

GENERAL SETTINGS MODE

All settings and display options for this product are accessible from the MAIN MENU.

NAVIGATING THROUGH MAIN MENU



To access MAIN MENU from any screen press **HOME**. Press **▲** or **▼** to highlight a desired option then press **ENTER** to activate it.

CHANGING SETTINGS

1. Press **▲** or **▼** to highlight the option you wish to change.
2. Press **ENTER** to select it.
3. Use the **▲ UP** or **▼ DOWN** buttons to change values.
4. Press **ENTER** confirm changes.

TIP: Pressing the will return you to the previous screen.

CLOCK SETTING

Auto-synchronization should be deactivated before you manually set the clock. To do this, follow the instructions stated below and turn the RF CLOCK function OFF in CLOCK SETTING mode.

1. From the HOME MENU access the GENERAL SETTING mode.

Press ▲ / ▼ to select CLOCK SETTING, then press **ENTER**.



2. CLOCK SETTING mode

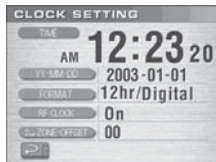

3. Choose the settings that need to be adjusted:

TIME	Set Hour and Minute
YY-MM-DD	Set Year, Month and Date
FORMAT	Set 12 or 24 hour format and Analog, Digital or Classic Clock display format
RF CLOCK	Set Auto synchronization on or off
2 nd ZONE-OFFSET	Set 2 nd zone-time
Exit	Return to previous page

- Press ▲ / ▼ to choose a setting (the selected item will flash).
- Press **ENTER** to start making adjustments.
- Press ▲ / ▼ to change values.
- Press **ENTER** to confirm changes.

TIP: Press **HOME** to return to MAIN MENU.

2nd ZONE-OFFSET

You can offset current local time to correspond with the time from another region (2nd zone).

For example, if the current local time is 1:30pm and the time in another region is 3:30pm, you should adjust the 2nd ZONE-OFFSET to +02 to compensate.



ALARM SETTING

When activated, the alarm starts quietly, then gradually becomes louder until it crescendos at 1 minute; it shuts off at two minutes.

1. From the HOME MENU access the GENERAL SETTING mode.

Press ▲ / ▼ to select ALARM SETTING, then press **ENTER**

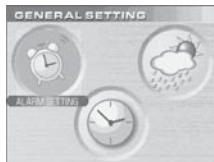

2. ALARM SETTINGS mode



3. Choose the settings that you want to adjust:

Alarm 1	Set Hour, Minute, Alarm type and Alarm on or off
Alarm 2	Set Hour, Minute, Alarm type and Alarm on or off
Exit	Return to previous page

4. Setting the alarm:

- Press ▲ / ▼ to choose an alarm (1 or 2).
The selected alarm will be swinging.
- Press **ENTER** begin adjusting values.
- Press ▲ / ▼ change values.
- Press **ENTER** to confirm changes.

A  will indicate that an alarm is active.

ALARM TYPES: DAILY AND WEEKDAYS ALARM

- DAILY alarm can be set to go off once at the set time everyday of the week.
- WEEKDAYS alarm will go off at the set time every weekday of the week (i.e., Monday to Friday only).

SNOOZE

Press **SNOOZE** to temporarily disable the alarm for 8 minutes. The alarm icon will swing in Clock-Alarm mode while Snooze is activated.

To deactivate the snooze function, press and hold the **SNOOZE** button for two seconds during the snooze period.

NOTE When the snooze function is enabled, changing the clock, calendar or alarm setting will disable the snooze setting.

WEATHER SETTING MODE

In this mode you can adjust various weather calibration settings, such as the unit of temperature and barometric display along with altitude settings for more accurate weather forecasting.

1. From the HOME MENU access the GENERAL SETTING mode.

Press ▲ / ▼ to select weather settings, then **ENTER**.



2. WEATHER SETTING mode

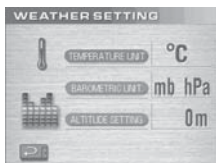

In this mode you can set:

Temperature	Select °C or °F temperature units
Barometric Unit	Select Mb/hPa or inHg pressure units
Altitude	Set the compensated altitude [-100m to 2500m] (default 0m)
Exit	Return to previous page

Press ▲ / ▼ to select the value you wish to change, then press **ENTER**. Adjust the values using ▲ / ▼ , press **ENTER** to keep them.

ALTITUDE COMPENSATION FUNCTION

Set the altitude corresponding to how far above or below you are to sea level to make barometric measurements accurate.



CLOCK-ALARM MODE

This is basically a viewing mode where time, date and alarm information is conveniently displayed. In this mode you can turn alarms 1 or 2 ON/OFF.



- Current time
- Zone time
- Calendar
- Two alarm settings

TURNING THE ALARM ON/OFF

In Clock-Alarm mode you can switch ON/OFF alarm 1 or 2 separately without going into the setting mode:

1. Press **CHANNEL** to select alarm 1 or 2
2. Press **▲** / **▼** to switch alarm on or off.
3. Press **ENTER** or wait 10 seconds to confirm the changes.

TIP: You can change the look of your display.

WEATHER FORECAST MODE

This product forecasts the next 12 to 24 hours of weather within a 30 to 50 km (19 - 31 mile) radius with 70 to 75 percent accuracy. A weather forecast with sound effect is always active:



Sunny



Partly Cloudy



Cloudy



Rainy



Snowy

The weather forecast symbol is updated every 15 minutes.

TEMPERATURE / PRESSURE / HYGRO MODE

With the press of a button, you can check the current indoor or outdoor temperature, relative humidity comfort level, trend, and record measurements. Outdoor measurements are taken by the remote sensors then relayed back to the main unit.

From the MAIN MENU access TEMP, HYGRO, PRESSURE mode.

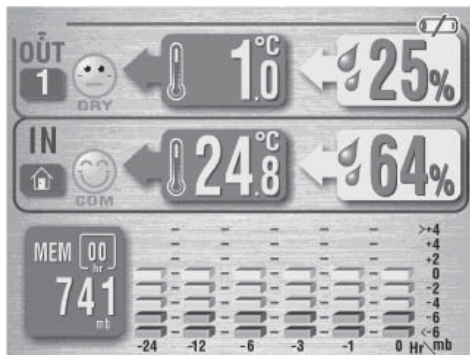

BAROMETER DISPLAY

This product tracks barometric pressure changes over the past 24 hours to provide a weather forecast. You can display current and past readings by pressing the ▲ / ▼ keys.

From the barometer display:

-1	1 hour ago
-3	3 hours ago
-6	6 hours ago
-12	12 hours ago
-24	24 hours ago

THERMO AND HYGRO MEMORY

Temperature and humidity are stored in the main memory. There are separate memories for the indoor and outdoor channel sensors.

To display a (MIN/MAX) reading, select a channel by pressing **CHANNEL**.



When the desired channel has been selected:

- MAX: Press and **HOLD** ▲ for 2 seconds.
- MIN: Press and **HOLD** ▼ for 2 seconds.

CLEAR MIN / MAX RECORDS

Press and hold ▲ and ▼ (simultaneously) for 2 seconds until you hear a beep.

CURRENT THERMO-HYGRO DISPLAY

Press **CHANNEL** to switch between 5 outdoor channels. A current trend corresponding to the selected channel will be displayed.



AUTO SCAN FUNCTION

When enabled, the thermo-hygro display for each channel will be displayed for 4 seconds before changing to the next channel.

To start auto scan, press and hold **CHANNEL** until you hear a beep (press **CHANNEL** again to exit auto scan mode).

COMFORT ZONE

The indoor and outdoor comfort zones are always shown, they display the relationship between temperature and humidity.

Zone	Temperature	Relative Humidity
 WET	Any	>70%
 COM	20 - 25 ° C (68 - 77 ° F)	40 - 70%
 DRY	Any	<40%

TRENDS

For each channel the following symbols represent:



Temperature



Humidity

A trend will show the changes along with the recorded maximum and minimum values taken over a 24-hour period.

Trends:



SYSTEM SETTING MODE

In this mode you can customize various system settings.

From the MAIN MENU, enter SYSTEM SETTING mode, then:

1. Press ▲ / ▼ to choose a setting, then press **ENTER** to start making changes.
2. Press ▲ / ▼ to make the desired changes, **ENTER** to confirm.

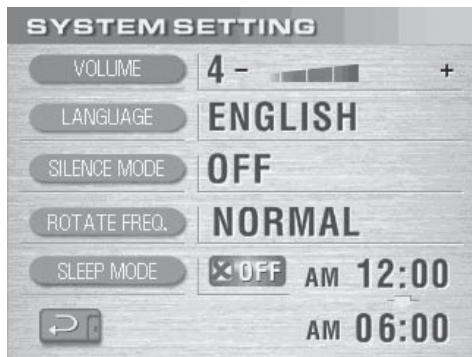

SYSTEM SETTINGS

- **Volume:** Adjust system volume levels
- **Language:** Select the display language, English, German, French, Italian or Spanish.
- **Silence mode: (ON)** No sound will be heard in animated display mode or the main menu.
- **Auto rotation frequency:** Adjust rotation speed (normal, fast, slow).
- **Sleep mode:** Program the LCD display to turn ON or OFF during a period of time. In this mode all features are still active but you cannot see the display or hear sounds. The display turns on when the alarm goes off or a button is pressed.

AUTO ROTATION DISPLAY MODE

When this function is enabled, the unit will automatically switch between the following modes:

- Weather forecast
- Clock-alarm
- Temperature/pressure/Hygro

You can adjust the speed at which each mode is displayed via the auto rotation frequency setting.



CLOCK ALARM DISPLAY MODE

This is a display mode that presents the time, date, and alarm one of the following ways:



Digital



Analog



Classic*

*In Classic display mode, the hourly chime is animated with a cuckoo bird and cuckoo sound.

NOTE You can set which clock is displayed from the CLOCK SETTNG mode. Access the FORMAT option to toggle between Digital, Analog and Classic views.

RESET SYSTEM

The **RESET** buttons are located on the back of the main unit and in the battery compartment for the remote unit. Press these buttons whenever you change the batteries, or whenever performance is not behaving as expected (e.g., unable to establish radio frequency link with remote unit or automatic clock, etc.).



NOTE After resetting the system all system information will be erased and returned to factory defaults. The main unit will also check battery condition.

DEFAULT SETTINGS

Date	1/1/2003
Time	00:00:00 (24 hour format) or 12:00:00 am (12 hour format)
Clock display	Time-second display mode
Daily/weekly alarm	Alarm disabled
Sleep Mode	Sleep start at 12:00 a.m. and sleep end at 6:00 a.m. & function disabled
Silence Mode	Off
Weather	Partly cloudy
Pressure display	Current pressure
Altitude	0m
Thermo-hygro display	Current indoor
Indoor temperature trend	Steady
Indoor humidity trend	Steady
Sensor search	Enabled
Receive RF clock	Enabled

Press **RESET** to restore all settings to factory defaults.

LOW BATTERY DETECTION

When battery levels get too low, the  icon will appear. Also, when no adaptor is connected, the  icon will be displayed.

The battery / adaptor status can be seen on:

- Clock display
- Weather display
- Remote thermo-hygro sensor



NOTE The main unit will display the channel battery status when the corresponding channel is selected.

SAFETY AND CARE

Wash the unit with a slightly damp cloth and mild detergent. Avoid dropping the unit or placing it in a high-traffic location.

WARNINGS

This product is designed to give you years of service if handled properly. Observe the following guidelines:

- Never immerse the unit in water. This can cause electrical shock and damage the unit.
- Do not subject the main unit to extreme force, shock, or fluctuations in temperature or humidity.
- Do not tamper with the internal components.
- Do not mix new and old batteries or batteries of different types.
- Do not use rechargeable batteries with this product.
- Remove the batteries if storing this product for a long period of time.
- Do not scratch the LCD display.
- Do not make any changes or modifications to this product. Unauthorized changes may void your right to use the product.
- The contents of this user guide are subject to change without notice.
- Images not drawn to scale.

**TROUBLESHOOTING**

Check here before contacting our customer service department.

Problem	Symptom	Remedy
Barometer	Unusual readings	Set altitude / unit
Calendar	Unusual date / month	Change language
Clock	Cannot adjust clock	Disable auto-synchronization
Clock	Cannot auto-synch	1. Adjust batteries 2. Press RESET 3. Manually activate auto-synch
Temp	Shows "LLL" or "HHH"	Temperature is out-of-range
Remote unit	Cannot locate remote unit	Check batteries
		Check location
Display	No display	Sleep Mode may be on. Press any key to activate the display again.

SPECIFICATIONS**Main unit dimensions**

L x W x H	165 x 124 x 39mm (6.5 x 4.88 x 1.54 inches)
Weight	432g (with batteries)

Remote unit dimensions

L x W x H	70 x 24.5 x 116mm (2.76 x 0.96 x 4.57 inches)
Weight	156g (with batteries)

Temperature

Unit	°C or °F
Indoor Range	-5 °C to 50 °C (23 °F to 122 °F)
Outdoor Range	-20 °C to 60 °C (-4 °F to 140 °F)
Resolution	0.1 °C (0.2 °F)
Comfort	20 °C to 25 °C (68 °F to 77 °F)
Memory	Minimum / maximum
Trend	+/- 0.5° change

Relative humidity

Range	25% to 95%
Resolution	1%
Comfort	40% to 70%
Memory	Minimum / maximum
Trend	3% change

Barometer

Unit	mb/hPa or inHg
Range	500 to 1050 mb (14.77 to 31.01 inHg)
Resolution	1mb (0.03 inHg)
Altitude	-100 to 2500 meters (-328 to 8202 feet)
Display	Sunny, partly cloudy, cloudy, rainy, snowy

Remote unit

RF frequency	433 MHz
Range	up to 50 meters (164 feet) with no obstructions
Transmission	every 1 minute
Channel No.	1, 2, 3, 4 or 5
Unit	°C or °F

Radio-controlled clock

Synchronization	Auto or disabled
Clock display	HH:MM:SS
Hour format	12hr AM/PM (MSF format) 24hr (DCF format)
Calendar	DD/MM; weekday selection in 5 languages (E, G, F, I, S)
Alarm	2 minute crescendo
Snooze	8 minutes

Power

Main unit	4.5V AC adaptor 4 x UM-3 (AA) 1.5V alkaline batteries (back-up)
Remote unit	2 x UM-3 (AA) 1.5V alkaline batteries

ABOUT OREGON SCIENTIFIC

Visit our website (www.oregonscientific.com) to learn more about Oregon Scientific products such as digital cameras; MP3 players; children's electronic learning products and games; projection clocks; health and fitness gear; weather stations; and digital and conference phones. The website also includes contact information for our customer care department in case you need to reach us, as well as frequently asked questions and customer downloads.

We hope you will find all the information you need on our website, however if you'd like to contact the Oregon Scientific Customer Care department directly, please visit:

www2.oregonscientific.com/service/support

OR

call 949-608-2848 in the US.

For international enquiries, please visit:
www2.oregonscientific.com/about/international/default.asp.



EC-DECLARATION OF CONFORMITY

This product contains the approved transmitter module that complies with the essential requirements of Article 3 of the R&TTE 1999 / 5 / EC Directive, if used as intended and the following standards have been applied:

Safety of information technology equipment

(Article 3.1.a of the R&TTE Directive)

Applied Standard **EN 60950: 2000**

Electromagnetic compatibility

(Article 3.1.b of the R&TTE Directive)

Applied Standards

ETSI EN 301 489-1-3 (Ver.1.4.1) : 2002-08

Efficient use of radio frequency spectrum

(Article 3.2 of the R&TTE Directive)

Applied Standards

ETSI EN 300 220-3 (Ver1.1.1) : 2000-09

Additional information:

The product herewith complies with the requirements of the Low Voltage Directive 73 / 23 / EC, the EMC Directive 89 / 336 / EC and carries the CE marking accordingly.

Carmelo Cubito

Agrate Brianza (MI) / Italy January 2004

Manufacturer's EU R&TTE Representative



COUNTRIES RTTE APPROVAL COMPLIED

All EC countries, Switzerland (CH)

and Norway (N)

© 2004 Oregon Scientific. All rights reserved.
086-003367-035

Free Manuals Download Website

<http://myh66.com>

<http://usermanuals.us>

<http://www.somanuals.com>

<http://www.4manuals.cc>

<http://www.manual-lib.com>

<http://www.404manual.com>

<http://www.luxmanual.com>

<http://aubethermostatmanual.com>

Golf course search by state

<http://golfingnear.com>

Email search by domain

<http://emailbydomain.com>

Auto manuals search

<http://auto.somanuals.com>

TV manuals search

<http://tv.somanuals.com>