



Advanced Weather Station with Atomic Time Model: BAR208HG USER MANUAL

CONTENTS

Overview	2
Front View	2
Back View	3
Remote Sensor	3
Getting Started	3
Insert Batteries	3
Remote Sensor	4
Sensor Data Transmission	4
Clock	5
Clock Reception	5
Manually Set Clock	5
Weather Forecast	6
Weather Warning Message	6
Temperature and Humidity	6
Ice Warning	6

Weather Trends	7
Moon Phase	7
Backlight	7
Reset	7
Precautions	7
Specifications	8
About Oregon Scientific	8
EU-Declaration of Conformity	8

OVERVIEW

FRONT VIEW (FIG 1)

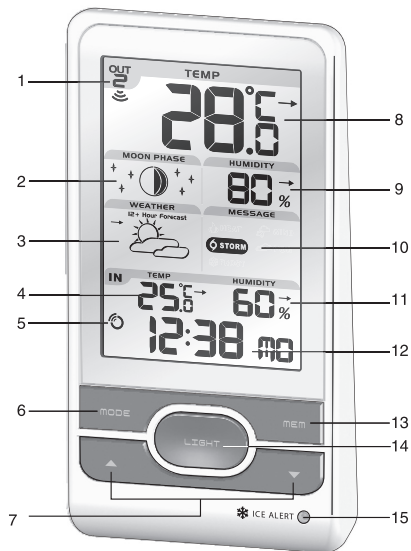

1. Remote sensor reception indicator
2. Moon phase reading
3. Weather forecast
4. Indoor temperature with temperature trend
5. Clock signal reception indicator
6. **MODE**: Change settings / display
7. ▲ / ▼ : Increase / decrease settings; activate / deactivate clock reception signal
8. Outdoor temperature with temperature trend
9. Outdoor humidity with humidity trend
10. Weather warning message
11. Indoor humidity with humidity trend
12. Clock with weekday
13. **MEM**: View current, maximum and minimum temperature / humidity
14. **LIGHT**: Activate backlight for 5 seconds
15. Ice alert LED indicator

BACK VIEW (FIG 2)

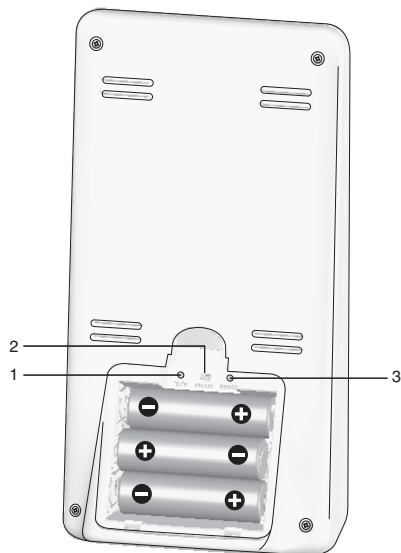

1. °C / °F: Select temperature unit
2. EU / UK: Select the nearest radio signal
3. **RESET**: Reset unit to default settings

REMOTE SENSOR (FIG 3)

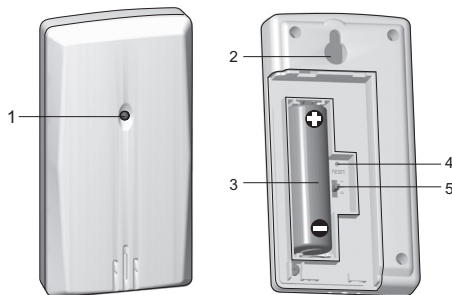

1. LED status indicator
2. Wall mount hole
3. Battery compartment
4. **RESET** hole
5. **CHANNEL** switch

GETTING STARTED

INSERT BATTERIES

1. Remove the battery compartment.
2. Insert the batteries, matching the polarities (see FIG 2).
3. Press **RESET** after each battery change.

 LOCATION	MEANING
Clock / alarm and Indoor temperature area	Main unit batteries low
Outdoor temperature area	Sensor batteries low

REMOTE SENSOR

The main unit can collect data from up to 3 sensors.

To set up the sensor:

1. Open the battery compartment (see FIG 3).
2. Select a channel then press **RESET**.
3. Close the battery door.
4. Place the sensor within 30 m (98 ft) of the main unit using the table stand or wall mount.

TIP Ideal placements for the sensor would be in any location on the exterior of the home at a height of not more than 1.5 m (5 ft) and which can shield it from direct sunlight or wet conditions for an accurate reading.

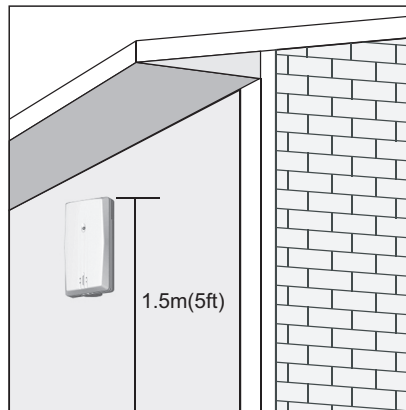

NOTE Use alkaline batteries for longer usage and consumer grade lithium batteries in temperatures below freezing.

SENSOR DATA TRANSMISSION

To search for a sensor:

Press and hold **▲ + MODE**.

The sensor reception icon in the remote sensor area shows the status:



ICON	DESCRIPTION
	Main unit is searching for sensor(s).
	A channel has been found.
	The sensor cannot be found.

TIP The transmission range may vary depending on many factors. You may need to experiment with various locations to get the best results.

CLOCK

CLOCK RECEPTION

This product is designed to synchronize its clock automatically with a clock signal.

Slide **EU / UK** to select the signal received.

- EU: DCF-77 signal: within 1500 km (932 miles) of Frankfurt, Germany.
- UK: MSF-60 signal: within 1500 km (932 miles) of Anthorn, England.

To enable / disable signal reception:

Press and hold **▲** to enable or **▼** to disable signal reception.

NOTE Reception takes 2-10 minutes. If the signal is weak, it can take up to 24 hours to get a valid signal. If signal

reception is unsuccessful, place your unit next to a window, press and hold **▲** to force another signal search.

Clock signal reception indicator:

STRONG SIGNAL	WEAK SIGNAL	NO SIGNAL

MANUALLY SET CLOCK

To set the clock manually, disable the signal reception first.

1. Press and hold **MODE**.
2. Press **▲** or **▼** to change the settings.
3. Press **MODE** to confirm.
4. The settings order is: time zone, 12/24 hr format, hour, minute, year, calendar mode (day – month / month – day), month, day and language.

Time zone offset sets the clock +/- 23 hours from the received clock signal time.





NOTE The language options are English (E), German (D), French (F), Italian (I), and Spanish (S).

To select display mode:

Press **MODE** to choose between clock with seconds / weekday / calendar / moon phase.



WEATHER FORECAST

This product forecasts the next 12 to 24 hours of weather within a 30-50 km (19-31 mile) radius with a 75% accuracy.

	Sunny
	Partially Cloudy
	Cloudy
	Rainy
	Snowy

WEATHER WARNING MESSAGE

The weather warning messages provide indications of probable circumstances that may arise based on the weather station's calculations. The meanings for the warnings are illustrated below:

Warning	Meaning
	Risk of high temperatures
	Risk of fast wind speeds
	Risk of a storm



FOG

Risk of foggy conditions



FROST

Risk of icy conditions

TEMPERATURE AND HUMIDITY

To toggle temperature unit:

Press °C / °F.

To auto-scan between sensors:

Press and hold ▼ + MEM to display each sensor's data for 3 seconds.

To end press ▲ .

To toggle between current, minimum and maximum records for the selected sensor:

Press MEM repeatedly.

To clear the records:

Press and hold MEM.

ICE WARNING

If the channel 1 sensor falls between 3°C to -2 °C (37°F to 28°F), LED indicator will flash, and will stop flashing once the temperature is out of this range.









WEATHER TRENDS

The temperature, humidity and pressure trend icons are based on recent sensor readings.

RISE	STEADY	FALL
		

MOON PHASE

In moon phase mode, press ▲ or ▼ to scan through the years (2001 to 2099).

	New Moon		Full Moon
	Waxing Crescent		Waning Gibbous
	First quarter		Last quarter
	Waxing Gibbous		Waning Crescent

NOTE Star icons around the moon phase will be displayed from 6 o'clock in the evening to 6 o'clock the next morning.

BACKLIGHT

Press **LIGHT** to activate backlight for 5 seconds.

RESET

Press **RESET** to return to the default settings.

PRECAUTIONS

- Do not subject the unit to excessive force, shock, dust, temperature or humidity.
- Do not cover the ventilation holes with any items such as newspapers, curtains etc.
- Do not immerse the unit in water. If you spill liquid over it, dry it immediately with a soft, lint-free cloth.
- Do not clean the unit with abrasive or corrosive materials.
- Do not tamper with the unit's internal components. This invalidates the warranty.
- Only use fresh batteries. Do not mix new and old batteries.
- Images shown in this manual may differ from the actual display.
- When disposing of this product, ensure it is collected separately for special treatment.
- Placement of this product on certain types of wood may result in damage to its finish for which Oregon Scientific will not be responsible. Consult the furniture manufacturer's care instructions for information.
- The contents of this manual may not be reproduced without the permission of the manufacturer.
- Do not dispose old batteries as unsorted municipal waste. Collection of such waste separately for special treatment is necessary.
- Please note that some units are equipped with a battery safety strip. Remove the strip from the battery compartment before first use.

NOTE The technical specifications for this product and the contents of the user manual are subject to change without notice.

SPECIFICATIONS

TYPE	DESCRIPTION
MAIN UNIT	
L x W x H	94 x 51 x 182.5 mm (3.70 x 2.01 x 7.19 in)
Weight	241 g (8.5 oz) without battery
Temperature range	-5°C to 50°C (23°F to 122°F)
Resolution	0.1°C (0.2°F)
Signal frequency	433 MHz
Humidity range	25% - 95%
Humidity resolution	1%
Power	3 x UM-3 (AA) 1.5 V batteries
REMOTE UNIT (THGN132N)	
L x W x H	50 x 22 x 96 mm (1.97 x 0.87 x 3.78 in)
Weight	62 g (2.22 ounces) without battery
Transmission range	30 m (98 ft) unobstructed
Temperature range	-20°C to 60°C (-4°F to 140°F)
Humidity range	25% - 95%
Power	1 x UM-3 (AA) 1.5 V battery

ABOUT OREGON SCIENTIFIC

Visit our website (www.oregonscientific.com) to learn more about Oregon Scientific products. If you're in the US and would like to contact our Customer Care department directly, please visit: www2.oregonscientific.com/service/support.

OR

Call 1-800-853-8883.

For international inquiries, please visit:



www2.oregonscientific.com/about/international

EU-DECLARATION OF CONFORMITY

Hereby, Oregon Scientific, declares that this Advanced Weather Station with Atomic Time (Model: BAR208HG) is in compliance with the essential requirements and other relevant provisions of Directive 1999/5/EC. A copy of the signed and dated Declaration of Conformity is available on request via our Oregon Scientific Customer Service.



COUNTRIES RTTE APPROVAL COMPLIED

All EC countries, Switzerland 
and Norway 

Free Manuals Download Website

<http://myh66.com>

<http://usermanuals.us>

<http://www.somanuals.com>

<http://www.4manuals.cc>

<http://www.manual-lib.com>

<http://www.404manual.com>

<http://www.luxmanual.com>

<http://aubethermostatmanual.com>

Golf course search by state

<http://golfingnear.com>

Email search by domain

<http://emailbydomain.com>

Auto manuals search

<http://auto.somanuals.com>

TV manuals search

<http://tv.somanuals.com>