

Advanced Weather Station
with Wireless Sensor Set
Model: WMR90A
USER MANUAL

CONTENTS

Introduction	1
Packing Contents	1
Wind Sensor	1
Rain Gauge	1
Overview	2
LCD Display	2
Wind Sensor	3
Rain Gauge	3
Getting Started	3
Set up Remote Wind Sensor	3
Set up Remote Rain Gauge.....	4
Set up Base Station	4
Base Station	4
Change Display / Setting	4
Clock Reception	4
Clock / Calendar	5
Clock Alarm	5
Moon Phase	5
Auto Scanning Function	5
Weather Forecast	5
Temperature and Humidity	5
Temperature and Humidity Trend	6
Comfort Level	6
Wind Direction / Speed	6
UVI / Barometer / Rainfall	6
UV Index	6
Barometer	7
Rainfall	7
Weather Alarms	7
Reset	7
Accessories – Sensors	7
Troubleshooting	7
Precautions	7
Specifications	7
About Oregon Scientific	8
FCC Statement	8
Declaration of Conformity	8

INTRODUCTION



Thank you for selecting the Oregon Scientific™ Advanced Weather Station with Wireless Sensor Set (WMR90A).

The base station is compatible with other sensors. To purchase additional sensors, please contact your local retailer.





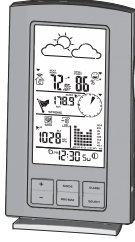





Sensors with this logo 3.0 are compatible with this unit.





PACKAGING CONTENTS

	
	1 x 6V Adapter
	
	4 x UM-3 / AA

WIND SENSOR

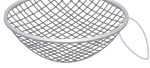
		
1 x Wind Sensor with "T-Shaped" Connector	1 x Wind Vane	1 x Top Pole
		
	1 x Wind Direction Indicator	
		
2 x Round U-Shaped Bolts	1 x Screw (Type A)	4 x UM-3 / AA
		
2 x Screws (Type B)	1 x Plastic Support Base	

RAIN GAUGE

		
1 x Rain Collector	1 x Filter	2 x UM-3 / AA
		
	4 x Screws (Type C)	6 x Washers

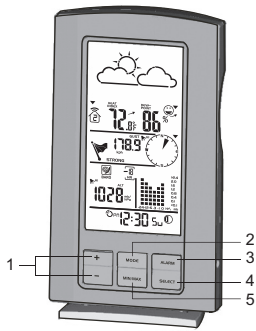

1. + / - : Increase or decrease the values of the setting
2. **MODE**: Switch between the different display modes / settings
3. **ALARM**: View and set alarms for barometer, temperature, humidity, rainfall and wind speed
4. **SELECT**: Switch between the different areas
5. **MIN / MAX**: Read the max / min memory record; activate / deactivate alarms

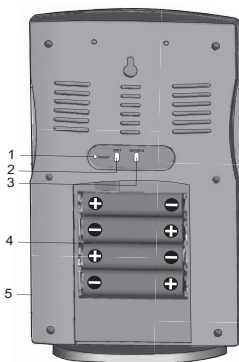

1. **RESET**: Returns unit to default settings
2. **UNIT**: Selects unit of measurement
3. **SEARCH**: Searches for sensors or for the radio-controlled clock signal
4. Battery compartment
5. AC adapter socket

LCD DISPLAY

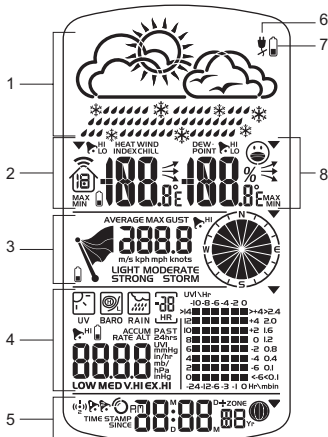

1. Weather Forecast Area
2. Temperature / Heat Index / Wind Chill Area
3. Wind Speed / Wind Direction Area
4. UVI / Barometer / Rainfall Area
5. Clock / Alarm / Calendar / Moon Phase Area
6. AC adapter icon - displays when unplugged
7. Low battery icon for base station
8. Humidity / Dew Point Area

Temperature / Heat Index / Wind Chill Area

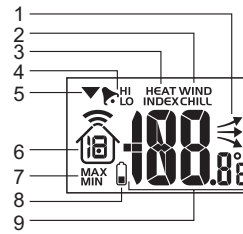

1. Temperature trend
2. Wind Chill level - temperature is showing
3. Heat Index level - temperature is showing
4. HI / LO temperature, HI Heat Index and LO Wind Chill alarms are set
5. Selected area icon
6. Indoor / Outdoor channel temperature and humidity is displayed
7. MAX / MIN temperature
8. Outdoor sensor battery is low
9. Temperature (°C / °F)

Wind Speed / Wind Direction Area

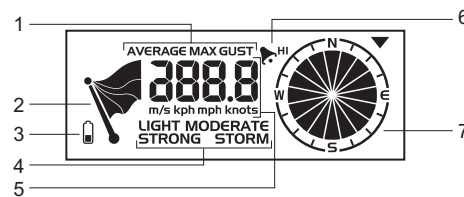

1. Wind speed levels: AVERAGE / MAX / GUST
2. Wind speed level indicator
3. Outdoor wind sensor battery is low
4. Wind speed level description
5. Gust wind or wind speed reading (m / s, kph, mph or knots)
6. HI gust wind alarm is set
7. Wind direction display

UVI / Barometer / Rainfall Area

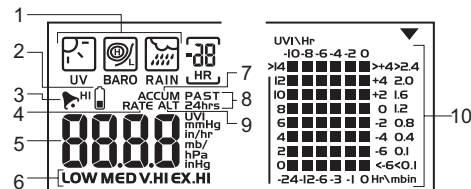

1. UVI / barometer / rainfall readings is showing
2. Outdoor UV / rain sensor battery is low
3. UV / barometer / rainfall alarm is set
4. Rain rate is showing
5. UVI / barometric pressure (mmHg, inHg or mb / h Pa) / rainfall readings (in / hr or mm / hr)
6. UVI level indicator
7. Accumulated rainfall is showing
8. Past 24hrs rainfall is showing
9. Altitude is showing
10. UVI / barometric pressure / rainfall historical bar chart display

Clock / Alarm / Calendar / Moon Phase Area

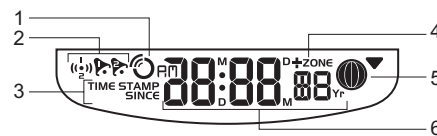

1. Clock radio reception
2. Alarm 1 and 2 are displayed and set
3. Timestamp is displayed
4. Offset time zone
5. Moon phase
6. Time / date / calendar

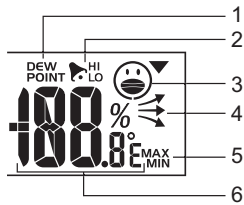

1. Dew point level - Temperature is showing
2. HI / LO humidity and Dew Point alarms are set
3. Comfort levels
4. Humidity trend
5. MAX / MIN humidity
6. Humidity reading

WIND SENSOR

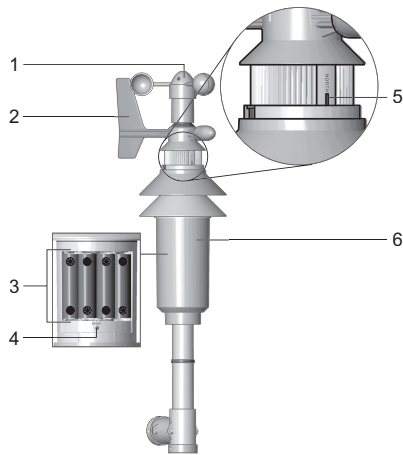

1. Wind vane measuring the wind speed
2. Wind direction sensor
3. Battery compartment
4. **RESET** hole
5. North indicator
6. Plastic sleeve protecting the batteries

RAIN GAUGE

Base and funnel

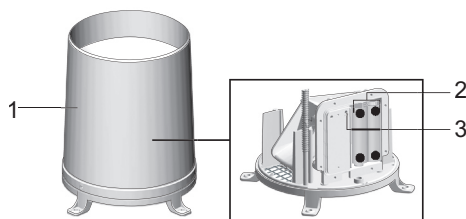

1. Rain gauge
2. Battery compartment
3. **RESET** button

Tipping bucket rain gauge

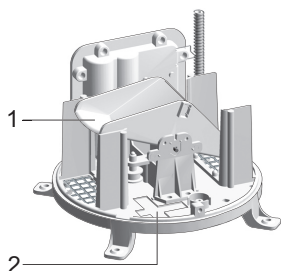

1. Funnel
2. Level indicator

GETTING STARTED

SET UP REMOTE WIND SENSOR

The wind sensor can take 3 readings:

- The wind speed and directions
- The outdoor temperature (Channel 1 only)
- The outdoor relative humidity (Channel 1 only)

The sensor is battery operated and is capable of transmitting data to the base station wirelessly within an approximate operating range of 100 meters (328 feet).

NOTE For best results, ensure that the wind direction indicator on the wind sensor points to the North to enable an accurate reading. The sensor also should be positioned in an open area away from trees or other obstructions.

To set up the wind sensor main body:

1. Assemble the wind direction pointer on the top of the wind sensor.
2. Use the screw (Type B) to fix.
3. Assemble the wind vanes on the top of the wind pointer.
4. Use the screw (Type B) to fix.

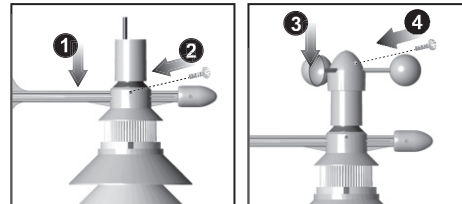

5. Hold the wind sensor upright and rotate the protective sleeve to the left to unlock.
6. Slide the sleeve down to open the battery compartment.
7. Insert batteries (4 x UM-3 / AA) in the compartment, matching the polarity (+ / -) and press **RESET**.
8. Slide the protective sleeve up to close the compartment.
9. Rotate the sleeve to the right to lock.

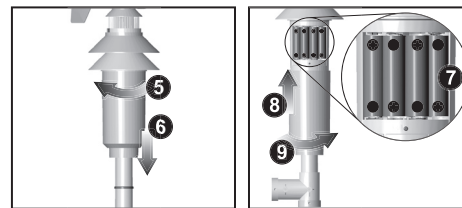

To set up the wind sensor main body on an existing pole:

1. Remove the screw that fixes the plastic connector at the end of the top pole.
2. Remove the plastic connector by sliding it off the pole.
3. Insert the pole into the plastic base.

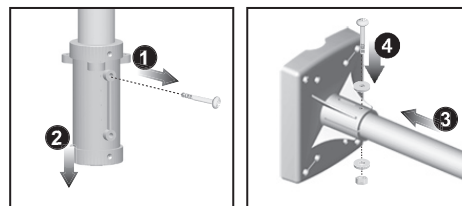

4. Insert the screw into the plastic base and pole and secure using the Type B screw and washers.
5. Align the back of the plastic base to an existing pole.
6. Using the 2 U-bolts, secure the plastic base to the pole by inserting the ends of the U-bolts into the holes on the plastic base and securing it with washers and bolts.
7. Slide Integrated wind sensor into the plastic base and pole.
8. Insert and screw the Type "X" bolt into the hole.

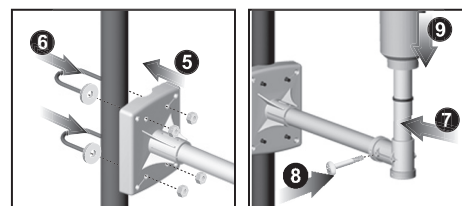

9. Slide the battery cover off.
10. Using a compass, rotate and align the wind direction sensor and the NORTH indicator line to the North.
11. Press the **RESET** button.
12. Slide the battery cover up
13. Rotate the sleeve clockwise to clock the cover

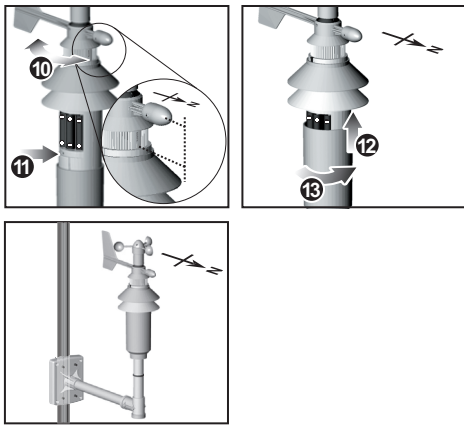

SET UP REMOTE RAIN GAUGE

The rain gauge collects rain and takes readings of the total rainfall over a period of time. The sensor can remotely transmit data to the base station.

The base station and rain gauge should be positioned within effective range: about 100 meters (328 feet) in an open area.

The rain gauge should be mounted horizontally about 1 meter (2-3 feet) from the ground in an open area away from trees or other obstructions to allow rain to fall naturally for an accurate reading.

To set up the sensor:

1. Remove screws and slide the cover up and insert the batteries (2 x UM-3 / AA), matching the polarity (+ / -). Press **RESET** after each battery change.

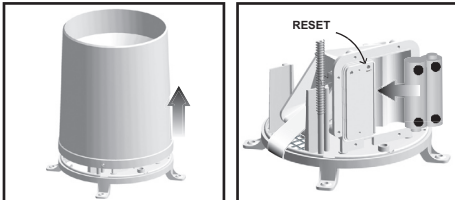

2. Remove the tape.

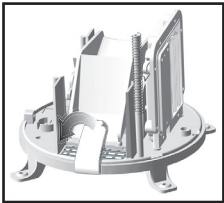

3. Put a few drops of water on the cross at the base of the funnel to check the horizontal level. Water will pool to the center of the cross when the rain gauge is level.

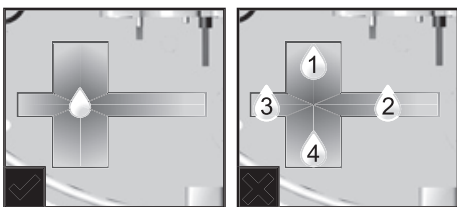

If water remains on 1-4, the gauge is not horizontal.

4. If necessary, adjust the level using the screw.

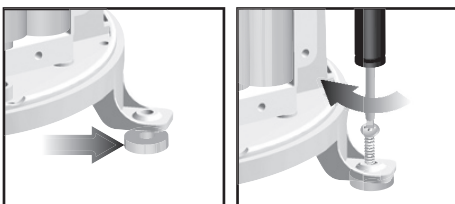

NOTE For best results, ensure the base is horizontal to allow maximum drainage of any collected rain.

SET UP BASE STATION

NOTE Install batteries in the remote sensor before the base station matching the polarities (+ and -).

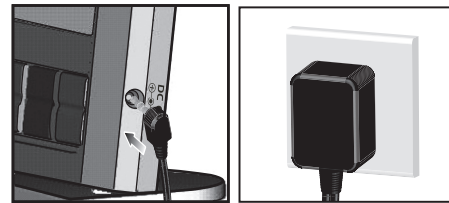

For continuous use, please install the AC adapter. The batteries are for back-up use only.

NOTE Please make sure the socket-outlet is installed near the equipment and is easily accessible.

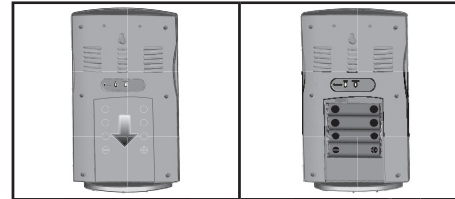

Install the base station batteries (4 x UM-3 / AA) matching the polarity + and -. Press **RESET** after each battery change.

NOTE Do not use rechargeable batteries. It is recommended that you use alkaline batteries with this product for longer performance.

The battery icon indicator  may appear in the following areas:

AREA	MEANING
Weather Forecast Area	Battery in the base station is low.  will show when AC adapter is disconnected.
Temperature / Heat Index / Wind Chill Area	The displayed channel indicates the outdoor sensor for which battery is low.
Wind Speed / Wind Direction Area	Battery in the wind sensor is low.
UVI / Barometer / Rainfall Area	Battery in the UV / Rain sensor is low.

BASE STATION

CHANGE DISPLAY / SETTING

To change the display and settings, use the following buttons: **SELECT**, **MIN/MAX**, **MODE** and **ALARM**. In addition, the **UNIT** and **SEARCH** buttons located at the back of the base station allows pre-setting of the remote sensor channels and the measurement units for display.

TIP To exit from the setting mode, push any button. Alternatively, the base station will automatically exit after 30 seconds.

CLOCK RECEPTION

This product is designed to synchronize its calendar clock automatically once it is brought within range of a radio signal:



WMR90A:

- WWVB-60 generated from the atomic clock in Fort Collins, Colorado. The radio signal range is 3219 km (2000 miles).

Press **RESET** whenever you change the selected setting.

The reception icon will blink when it is searching for a signal. If the radio signal is weak it can take up to 24 hours to get a valid signal reception.

 indicates the status of the clock reception signal.

ICON	MEANING
	Time is synchronized. Receiving signal is strong
	Time is not synchronized. Receiving signal is weak

To enable (and force a signal search) / disable the clock radio reception (clock synchronization):

1. Press **SELECT** to navigate to the Clock / Calendar / Alarm Area.  will show next to the Area.
2. Press and hold **SEARCH**.

 appears when it is enabled.

NOTE For best reception, the base station should be placed on a flat, non-metallic surface near a window in an upper floor of your home. The antenna should be placed away from electrical appliances and not be moved around when searching for a signal.

CLOCK / CALENDAR

To manually set the clock:

(You only need to set the clock and calendar if you have disabled the clock radio reception.)

1. Press **SELECT** to navigate to the Clock Area. ▼ will show next to the Area.
2. Press and hold **MODE** to change the clock setting. The setting will blink.
3. Press + or - to decrease or increase the setting value.
4. Press **MODE** to confirm.
5. Repeat steps 1 to 5 to set the time zone offset hour (+ / -23 hours), 12 / 24 hour format, hour, minute, year, date / month format, month, date and weekday language.

NOTE If you enter +1 in the time zone setting, this will give you your regional time plus 1 hour.



NOTE The weekday is available in English, French, German, Italian or Spanish.

To change the clock display:



1. Press **SELECT** to navigate to the Clock Area. ▼ will show next to the Area.
2. Press **MODE** to toggle between:
 - Clock with Seconds
 - Clock with Weekday
 - Calendar

CLOCK ALARM





The clock has 2 alarms that can be set to sound with a beep.

ICON	MEANING
	Alarm 1 or 2 is displayed
	Alarm 1 or 2 is activated
No icons	No alarm is set

To set an alarm:









1. Press **SELECT** to navigate to the Clock Area. ▼ will show next to the Area.
2. Press **ALARM** to toggle between alarm 1 () and alarm 2 () display.
3. When you've selected the alarm you wish to change, press and hold **ALARM**. The alarm setting will blink.
4. Press + or - to change the setting.
5. Press **ALARM** to confirm.

To activate / deactivate an alarm:

1. Press **SELECT** to navigate to the Clock Area. ▼ will show next to the Area.
2. Press **ALARM** to toggle between alarm 1 () and alarm 2 () .
3. Press **MIN/MAX** to activate or deactivate the alarm.  or  appears when the alarm is activated.

MOON PHASE

The Calendar must be set for this feature to work (see Clock / Calendar section).

ICON	DESCRIPTION
	New moon
	Waxing crescent
	First quarter
	Waxing gibbous
	Full moon
	Waning gibbous
	Third quarter
	Waning crescent

AUTO SCANNING FUNCTION

To activate the outdoor temperature and humidity auto-scan function:





1. Press **SELECT** to navigate to the Temperature or Humidity Area. ▼ will show next to the Area.
2. Press and hold **MODE** to activate auto-scan. The temperature and humidity display will scroll from indoor to ch1 through to ch10.
3. Press **MIN/MAX** or **MODE** or **ALARM** to stop the auto-scan.

NOTE Channel 1 is used for the outdoor temperature and humidity sensor in the remote wind sensor. Additional temperature and humidity sensors can use other channels.

WEATHER FORECAST

The weather display in the top part of the screen shows the current weather and the weather forecast for the next 12-24 hours within a 30-50 km (19-31 mile) radius.

Weather Forecast Area

ICON	DESCRIPTION
	Sunny
	Partly cloudy
	Cloudy
	Rainy
	Snowy

TEMPERATURE AND HUMIDITY

The weather station displays indoor and outdoor readings for:

1. Current, minimum and maximum temperatures and relative humidity.
2. Comfort level indicator and trend line.
3. Heat index, wind chill and dew point level.

The weather station can connect up to 10 remote sensors.

NOTE Channel 1 is dedicated for outdoor temperature and humidity in the wind sensor.

 shows which remote sensor's data you are viewing.

 appears when indoor data is displayed.

The timestamp records the date and time when storing the temperature and humidity readings in memory.

To select the temperature measurement unit:

Press **UNIT** (at the back of the base station) to select °C / °F.

NOTE The unit of all temperature related displays will be changed simultaneously.

To view readings from indoor / outdoor sensors (1-10) for temperature and humidity:

1. Press **SELECT** to navigate, select the Temperature or Humidity Area. ▼ will show next to the Area.
2. Press + or - to select the channel.

To view minimum and maximum temperature or humidity:

1. In the Temperature or Humidity Area, press **MODE** repeatedly to cycle through the readings for:
 - Current Temperature
 - Heat Index
 - Wind Chill
 - Dew Point
 - Humidity

2. For each of the above readings, press **MIN/MAX** repeatedly to toggle respectively between:
 - Current / MAX / MIN temperature
 - Current / MAX heat index
 - Current / MIN wind chill
 - Current / MAX / MIN dew point
 - Current / MAX / MIN humidity

The timestamp is displayed accordingly in the Clock Area.

To clear the memories and timestamp for the temperature, heat index, wind chill, humidity and dew point readings:

In the Temperature or Humidity Area, press and hold **MIN/MAX** to clear the readings.

To change the high / low temperature, heat index, wind chill, humidity and dew point alarms:

1. In the Temperature or Humidity Area, press **ALARM** repeatedly to toggle between high / low alarms for temperature, heat index, wind chill, humidity and dew point readings.

- Press and hold **ALARM** to enter the alarm setting.
- Press + or - to set the desired values.
- Press **ALARM** to confirm the setting.



To activate / deactivate the high / low temperature, heat index, wind chill, humidity and dew point alarms:

- In the Temperature or Humidity Area, press **ALARM** repeatedly to select the desired alarm.
- Press **MIN/MAX** to activate or deactivate the alarm.

NOTE The dew point advises at what temperature condensation will form. The wind chill factor is based on the combined effects of temperature and wind speed.



TEMPERATURE AND HUMIDITY TREND

The trend lines are shown next to the temperature and humidity readings. The trend is shown as follows:

TREND ICON	DESCRIPTION
	Rising
	Steady
	Falling

COMFORT LEVEL

The Comfort Zone icon indicates how comfortable the climate is based on current temperature and humidity measurements:

TREND ICON	DESCRIPTION
	Comfortable
	Neutral
	Uncomfortable

WIND DIRECTION / SPEED

The base station provides wind speed and wind direction information.

To read the wind direction find the compass point the ▼ is pointing to.



The timestamp records the date and time when storing the wind speed readings.





To select the wind speed unit:

Press **UNIT** (at the back of the base station) to switch between:

- Metres per second (m / s)
- Kilometers per hour (kph)
- Miles per hour (mph)
- Knots (knots)

288.8
m/s kph mph knots

The wind level is shown by a series of icons:

ICON	LEVEL	DESCRIPTION
	N/A	<2 mph (<4km/h)
	Light	2-8 mph (3~13 km/h)
	Moderate	9-25 mph (~14-41 km/h)
	Strong	26-54 mph (~42-87 km/h)
	Storm	>55 mph (>88 km/h)

To display the AVERAGE and GUST wind:

- Press **SELECT** to navigate to the Wind Speed and Wind Direction Area. ▼ will show next to the Area.
- Press **MODE** to toggle between AVERAGE and GUST wind readings.

To display the maximum speed and direction for gust wind:

In the Wind Speed and Wind Direction Area, press **MIN/MAX** to toggle between wind speed / MAX GUST wind readings. The timestamp is displayed accordingly in the Clock Area.

To clear the memories and timestamp for the wind readings:

In the Wind Speed and Wind Direction Area, press and hold **MIN/MAX** to clear the readings.

To change the high gust wind speed alarm:

- In the Wind Speed and Wind Direction Area, press and hold **ALARM** to enter the high gust wind alarm setting.
- Press + or - to set the desired values.
- Press **ALARM** to confirm the settings.

To activate / deactivate the high gust wind speed alarm:

- In the Wind Speed and Wind Direction Area, press **ALARM** repeatedly to select the desired alarm.
- Press **MIN / MAX** to activate or deactivate the alarm.

UVI / BAROMETER / RAINFALL

The weather station works with one UV sensor and one rain gauge. The station is capable of storing and displaying the hourly history data for the last 10 hours of UV index, and 24 hours of rainfall and barometric pressure readings.

UVI	BAROMETER	RAINFALL
UVI\Hr -10-8-6-4-2 0 >14 12 10 8 6 4 2 0	>>4 +4 +2 0 -2 -4 -6 <-6 -24-12-6-3-1 0 Hr\mb	>2.4 2.0 1.6 1.2 0.8 0.4 0.1 <0.1 -24-12-6-3-1 0 Hr\ in

The bar chart display shows the current and historical data for the UV index, barometric pressure and rainfall readings.

To view the UV / Barometer / Rainfall readings:

- Press **SELECT** to navigate to the UV / Barometer / Rainfall Area. ▼ will show next to the Area.
- Press **MODE** to toggle between UVI / Barometer / Rainfall readings. The corresponding icon will appear:

UVI	BAROMETER	RAINFALL
		
UV	BARO	RAIN

- Press + or - to view the historical data selected area. The corresponding historical readings are showing.

NOTE The number shown in the HR icon indicates how long ago each measurement was taken (e.g. 2 hours ago, 3 hours ago, etc.).

To select the measurement unit for the barometer or rainfall readings:

In the UV / Barometer / Rainfall Area, press **UNIT** (at the back of the base station) to switch between:

- Barometer: Millimeters of mercury (**mmHg**), inches of mercury (**inHg**), millibars per hectopascal (**mb / hpa**).
- Rainfall: Millimeters (**mm**), inches (**in**), inches per hour (**in / hr**) or millimeters per hour (**mm / hr**).

UV INDEX

The UV index levels are as follows:

UV INDEX	DANGER LEVEL	ICON
0-2	Low	LOW
3-5	Moderate	MED
6-7	High	HI
8-10	Very high	V.HI
11 and above	Extremely high	EX.HI

To change the high UV alarm:

- In the UV / Barometer / Rainfall Area and UVI reading display, press and hold **ALARM** to enter the high UV alarm setting.
- Press + or - to set the desired values.
- Press **ALARM** to confirm the settings.

To activate / deactivate the high UV alarm:

- In the UV / Barometer / Rainfall Area and UVI reading display, press **ALARM** repeatedly to select the desired alarm.
- Press **MIN/MAX** to activate or deactivate the alarm.

BAROMETER

To change the barometer alarm:

1. In the UV / Barometer / Rainfall Area and Barometer reading display, press and hold **ALARM** to enter the Barometer alarm setting.
2. Press + or - to set the desired values.
3. Press **ALARM** to confirm the settings.

To activate / deactivate the barometer alarm:

1. In the UV / Barometer / Rainfall Area and Barometer reading display, press **ALARM** repeatedly to select the desired alarm.
2. Press **MIN/MAX** to activate or deactivate the alarm.

To set the altitude level compensation for the Barometer readings:

1. In the UV / Barometer / Rainfall Area and Barometer reading display, press and hold **MODE** to enter the altitude setting.
2. Press + or - to set the desired values.
3. Press **MODE** to confirm the setting.

RAINFALL

To view the current hour, accumulated or last 24 hours rainfall history:

In the UV / Barometer / Rainfall Area and Rainfall reading display, press **MIN/MAX** repeatedly to toggle between current, past 24 hours or accumulated rainfall. The clock line will change to display the start time when the accumulated rainfall is displayed. The icon **SINCE** appears and the start date is showing.

To toggle between rainfall & rain rate display:

In the UV / Barometer / Rainfall Area and Rainfall reading display, press and hold **MODE**.

To reset the accumulated rainfall and timestamp:

In the UV / Barometer / Rainfall Area and Rainfall reading display, press and hold **MIN/MAX** to reset the accumulated rainfall to '0' and to set the timestamp to current date and time.

To change the HI rainfall rate alarm:

1. In the UV / Barometer / Rainfall Area and Rainfall reading display, press and hold **ALARM** to enter the Rainfall alarm setting.
2. Press + or - to set the desired values.
3. Press **ALARM** to confirm the settings.

To activate / deactivate the HI rainfall rate alarm:

1. In the UV / Barometer / Rainfall Area and Rainfall reading display, press **ALARM** repeatedly to select the desired alarm.
2. Press **MIN/MAX** to activate or deactivate the alarm.

WEATHER ALARMS

Weather alarms are used to alert you of certain weather conditions. Once activated, the alarm will go off when a certain criterion is met.

Alarms can be set for:

- Indoor and outdoor high/low temperatures, dew point and high/low humidity
- High Heat Index
- High Gust Wind
- Low wind chill
- High UV
- Pressure drop
- High rain rate

See the relevant section for how to set the alarm.

To silence any alarm: Press any button.

RESET

Press **RESET** to return to the default settings.

ACCESSORIES – SENSORS

This product can work with up to 10 sensors at any one time to capture outdoor temperature, relative humidity or UV readings in various locations. Optional wireless remote sensors such as those listed below can be purchased separately. For more information, please contact your local retailer.

- Thermo-hygro THGR800 (3-Ch)
- Thermo-hygro THGR810 (10-Ch)
- UV UVN800

TROUBLESHOOTING

PROBLEM	SYMPTOM	REMEDY
Barometer	Strange readings	Set unit
Calendar	Strange date / month	Change language
Clock	Cannot adjust clock	Disable radio-controlled clock
	Cannot auto-synch	1. Adjust batteries 2. Press RESET 3. Manually activate radio controlled clock
Temp	Shows "LLL" or "HHH"	Temperature is out-of-range
Remote sensor	Cannot locate remote sensor	1. Check batteries 2. Check if sensors are within range

PRECAUTIONS

- Do not subject the unit to excessive force, shock, dust, temperature or humidity.
- Do not cover the ventilation hole with any items such as newspapers, curtains etc.
- Do not immerse the unit in water. If you spill liquid over it, dry it immediately with a soft, lint-free cloth.
- Do not clean the unit with abrasive or corrosive materials.
- Do not tamper with the unit's internal components. This invalidates the warranty.
- Only use fresh batteries. Do not mix new and old batteries.
- Images shown in this manual may differ from the actual display.
- When disposing of this product, ensure it is collected separately for special treatment.
- Placement of this product on certain types of wood may result in damage to its finish for which Oregon Scientific will not be responsible. Consult the furniture manufacturer's care instructions for information.
- The contents of this manual may not be reproduced without the permission of the manufacturer.
- Do not dispose old batteries as unsorted municipal waste. Collection of such waste separately for special treatment is necessary.
- Please note that some units are equipped with a battery safety strip. Remove the strip from the battery compartment before first use.

NOTE The technical specifications for this product and the contents of the user manual are subject to change without notice.

SPECIFICATIONS

BASE STATION

Dimensions (L x W x H)	140 x 16 x 177 mm (5.5 x 0.6 x 6.9 in)
Weight	250g (8.82 oz) without battery

INDOOR BAROMETER

Barometer unit	mb/hPa, inHg and mmHg
Measuring range	700 – 1050mb/hPa
Accuracy	+/- 10 mb/hPa
Resolution	1mb (0.0 inHg)
Altitude setting	Sea level User setting for compensation
Weather display	Sunny, Partly Cloudy, Cloudy, Rainy and Snowy
Memory	Historical data and bar chart for last 24hrs

INDOOR TEMPERATURE

Temp. unit	°C / °F
Displayed range	0°C to 50°C (32°F to 122°F)
Operating range	-30°C to 60°C (-4°F to 140°F)
Accuracy	0°C - 40°C: +/- 1°C (+/- 2.0°F) 40°C - 50°C: +/- 2°C (+/- 4.0°F)
Comfort	20°C to 25°C (68°F to 77°F)
Memory	Current, min and max temp. Dew Point w/ min and max
Alarm	Hi / Lo

INDOOR RELATIVE HUMIDITY

Displayed range	2% to 98%
Operating range	25% to 90%
Resolution	1%
Accuracy	25% - 40%: +/- 7% 40% - 80%: +/- 5% 80% - 90%: +/- 7%
Comfort	40% to 70%

Memory	Current, min and max
Alarm	Hi / Lo

RADIO-CONTROLLED / ATOMIC CLOCK

Synchronization	Auto or disabled
Clock display	HH:MM:SS
Hour format	12hr AM/PM or 24hr
Calendar	DD/MM or MM/DD
Weekday in 5	(E, G, F, I, S) languages
Battery	4 x UM-3 (AA) 1.5V batteries
AC adapter	6V

REMOTE WIND SENSOR UNIT

Weight	556 g (1.23 lbs) without battery
Wind speed unit	m/s, kph, mph, knots
Speed accuracy	2 m/s ~ 10 m/s (+/- 3 m/s) 10 m/s ~ 56 m/s (+/- 10%)
Direction accuracy	16 positions
Transmission of Memory	Approx. every 14 seconds wind speed signal Max speed gust

OUTDOOR TEMPERATURE

Temp. unit	°C / °F
Displayed range	-50°C to 70°C (-58°F to 158°F)
Operating range	-30°C to 60°C (-4°F to 140°F)
Accuracy	-20°C - 0°C: +/- 2°C (+/- 4.0°F) 0°C - 40°C: +/- 1°C (+/- 2.0°F) 40°C - 50°C: +/- 2°C (+/- 4.0°F) 50°C - 60°C: +/- 3°C (+/- 6.0°F)
Comfort	20°C to 25°C (68°F to 77°F)
Memory	Current, min and max temp. Dew Point w/ max and min Wind chill temp. and min

RELATIVE HUMIDITY

Displayed range	2% to 98%
Operating range	25% to 90%
Resolution	1%
Accuracy	25% - 40%: +/- 7% 40% - 80%: +/- 5% 80% - 90%: +/- 7%
Comfort	40% to 70%
Memory	Current, min and max

RF TRANSMISSION

RF frequency	433MHz
Range	Up to 100 meters (328 feet) with no obstructions
Transmission	Approx. every 60 seconds
No. of Channel	1 for Wind/ Rain/ UV and 10 for Temp. / Humidity
Battery	4 x UM-3 (AA) 1.5V

REMOTE RAIN GAUGE

Dimensions (L x W x H)	107 x 87 x 56 mm (4.2 x 3.4 x 2.2 inches)
Weight	134 g (0.3 lbs) without battery
Rainfall unit	Mm/hr and in/hr
Range	0 mm/hr - 999 mm/hr
Resolution	1 mm/hr
Accuracy	< 15 mm/hr: +/- 1 mm 15 mm to 9999 mm: +/- 7%
Memory	Past 24hrs, hourly and accumulated from last memory reset
Battery	2 x UM-3 (AA) 1.5V

ABOUT OREGON SCIENTIFIC

Visit our website (www.oregonscientific.com) to learn more about Oregon Scientific products. If you're in the US and would like to contact our Customer Care department directly, please visit: www2.oregonscientific.com/service/support

OR

Call 1-800-853-8883.

For international inquiries, please visit: www2.oregonscientific.com/about/international

FCC STATEMENT

This device complies with Part 15 of the FCC Rules. Operation is subject to the following two conditions: (1) This device may not cause harmful interference, and (2) This device must accept any interference received, including interference that may cause undesired operation.

WARNING Changes or modifications not expressly approved by the party responsible for compliance could void the user's authority to operate the equipment.

NOTE This equipment has been tested and found to comply with the limits for a Class B digital device, pursuant to Part 15 of the FCC Rules. These limits are designed to provide reasonable protection against harmful interference in a residential installation.

This equipment generates, uses and can radiate radio frequency energy and, if not installed and used in accordance with the instructions, may cause harmful interference to radio communications. However, there is no guarantee that interference will not occur in a particular installation. If this equipment does cause harmful interference to radio or television reception, which can be determined by turning the equipment off and on, the user is encouraged to try to correct the interference by one or more of the following measures:

- Reorient or relocate the receiving antenna.
- Increase the separation between the equipment and receiver.
- Connect the equipment into an outlet on a circuit different from that to which the receiver is connected.
- Consult the dealer or an experienced radio / TV technician for help.

DECLARATION OF CONFORMITY

The following information is not to be used as contact for support or sales. Please call our customer service number (listed on our website at www.oregonscientific.com or on the warranty card for this product) for all inquiries instead.

We

Name: Oregon Scientific, Inc.
Address: 19861 SW 95th Ave., Tualatin, Oregon 97062 USA
Telephone No.: 1-800-853-8883

declare that the product

Product No.: WMR90A
Product Name: Advanced Weather Station with Wireless Sensor Set
Manufacturer: IDT Technology Limited
Address: Block C, 9/F, Kaiser Estate, Phase 1, 41 Man Yue St., Hung Hom, Kowloon, Hong Kong

is in conformity with Part 15 of the FCC Rules. Operation is subject to the following two conditions:

1. This device may not cause harmful interference.
2. This device must accept any interference received, including interference that may cause undesired operation.

Free Manuals Download Website

<http://myh66.com>

<http://usermanuals.us>

<http://www.somanuals.com>

<http://www.4manuals.cc>

<http://www.manual-lib.com>

<http://www.404manual.com>

<http://www.luxmanual.com>

<http://aubethermostatmanual.com>

Golf course search by state

<http://golfingnear.com>

Email search by domain

<http://emailbydomain.com>

Auto manuals search

<http://auto.somanuals.com>

TV manuals search

<http://tv.somanuals.com>