

Oregon SCIENTIFIC

Wireless Weather Forecaster with Temperature Display and Self - Setting Atomic Clock MODEL: BAR686A

USER MANUAL

INTRODUCTION

Thank you for selecting this Oregon Scientific™ Wireless Weather Forecaster with Temperature Display and Self - Setting Atomic Clock (BAR686A). This clock is supplied with a remote sensor (THN122N) and can support up to 3 sensors in total (additional sensors sold separately).

NOTE Please keep this manual handy as you use your new product. It contains practical step-by-step instructions, as well as technical specifications and warnings you should know about.

CLOCK OVERVIEW

FRONT VIEW

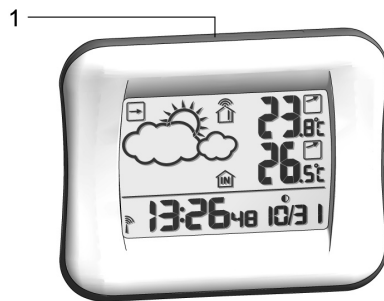

1. SNOOZE

BACK VIEW

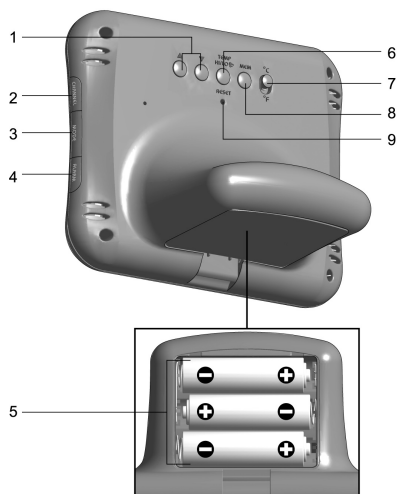

- ▲ / ▼ : Increase / decrease setting; activate / deactivate clock reception signal
- CHANNEL: Switch remote sensor display
- MODE: Change settings / display
- ALARM: View alarm status; set alarm
- Battery compartment
- TEMP HI / LO : Change settings or enable / disable hi or lo temperature alarm for channel 1
- °C / °F: Select temperature unit
- MEM: View current, maximum and minimum temperature / humidity
- RESET: Reset unit to default settings

LCD DISPLAY

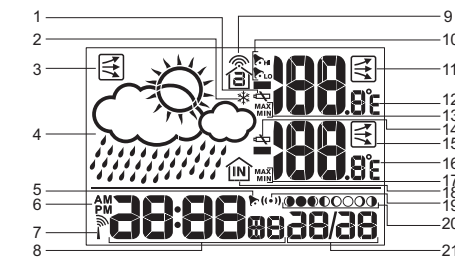

- Sensor battery low
- Ice warning is active
- Pressure trend
- Weather Forecast
- Alarm set
- AM / PM mode selected
- Clock signal reception
- Clock
- Sensor reception icon
- Hi / lo temperature alarm
- Outdoor temperature trend
- Outdoor temperature
- Max / Min icon
- Main unit battery low
- Indoor temperature trend
- Indoor temperature
- Max / Min icon
- Main unit sensor icon
- Alarm mode
- Moon Phase
- Day and Month display

REMOTE SENSOR (THN122N)

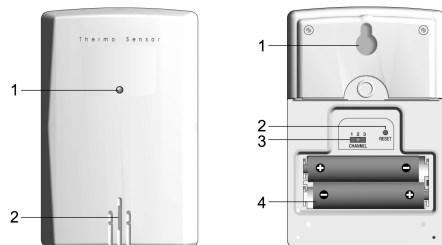

- LED status indicator: Blinks red during data transmission
- Ventilation duct
- Wall mount hole
- RESET hole
- CHANNEL switch
- Battery compartment

GETTING STARTED

SETTING UP THE CLOCK

Insert batteries before first use, matching the polarity (+ and -). **RESET** after each battery change.

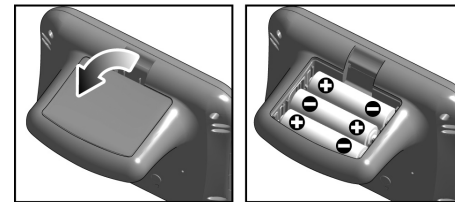

indicates main unit batteries are low.

NOTE Do not use rechargeable batteries. We recommend that you use alkaline batteries with this product for longer usage and lithium batteries in temperatures below freezing.

REMOTE SENSOR

The sensor collects temperature readings approx. every 40 seconds and sends them to the main unit. The main unit can collect data from up to 3 sensors.

To set up the sensor:

- Remove the screws from the battery door.
- Insert the batteries, matching the polarity (+ / -).

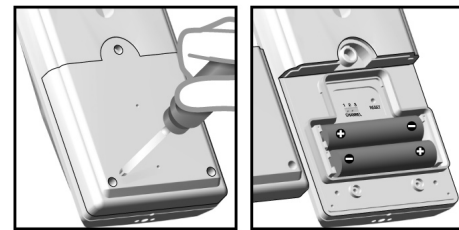

- Select a channel. Make sure you use a different channel for each sensor.
- Place the sensor near the main unit. Press **RESET** on the sensor.
- Simultaneously press **CHANNEL** and **MEM** on the main unit to initiate signal sending between the sensor and main unit.
- Close the battery door and secure the screws.
- Place the sensor in the desired location using the table stand or wall mount.

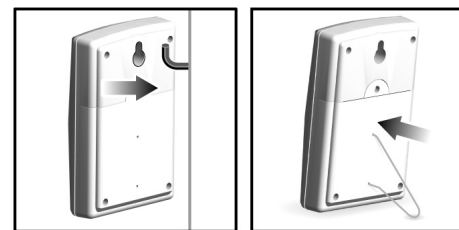

For best results:

- Place the sensor out of direct sunlight and moisture.
- Do not place the sensor more than 30 m (100 ft) from the main (indoor) unit.
- Position the sensor so that it faces the main (indoor) unit, minimizing obstructions such as doors, walls, and furniture.
- Place the sensor in a location with a clear view to the sky, away from metallic or electronic objects.
- Position the sensor close to the main unit during cold winter months as below-freezing temperatures may affect battery performance and signal transmission.

The transmission range may vary depending on many factors. You may need to experiment with various locations to get the best results.

Standard Alkaline batteries contain significant amounts of water. Because of this they will freeze in low temperatures of approximately -12°C (10°F). Disposable Lithium batteries have a much lower threshold for temperature with an estimated freezing range of below -30°C (-22°F).

Wireless ranges can be impacted by a variety of factors such as extremely cold temperatures. Extreme cold may temporarily reduce the effective range between the sensor and the base station. If the unit's performance fails due to low temperature, the unit will resume proper functioning as the temperature rises to within the normal temperature range (i.e. no permanent damage will occur to the unit due to low temperatures).

SENSOR DATA TRANSMISSION

Data is sent from the sensor(s) every 40 seconds. The sensor reception icon in the remote sensor area shows the status.

ICON	DESCRIPTION
	Main unit is searching for the sensor(s)
	A channel has been found
	Sensor 1 is sending data
	The sensor cannot be found. Search for the sensor or check batteries

To search for a sensor:

Simultaneously, press and hold **MEM** and **CHANNEL** for 2 seconds.

NOTE If the sensor is still not found, check the batteries, obstructions, and remote unit location.

CLOCK

CLOCK RECEPTION

This product is designed to synchronize its date and time automatically once it is within range of the WWVB-60 signal from the atomic clock in Boulder, Colorado.

The sensor collects the radio signals whenever it is within 1500 km (932 miles) of a signal.

NOTE Initial reception takes 2-10 minutes for first set up or when **RESET** is pressed. Once complete, the reception icon will stop blinking. If the signal is weak, it can take up to 24 hours to get a valid signal.

RECEPTION SIGNAL

Clock signal reception indicator:

STRONG SIGNAL	WEAK SIGNAL	NO SIGNAL

To enable and force a signal search:

Press and hold ▲ for 2 seconds.

To disable the signal reception:

Press and hold ▼ for 2 seconds.

flashes when it is disabled.

SET CLOCK

To manually set the clock make sure the clock signal reception is disabled.

- Press and hold **MODE** for 2 seconds.
- Select the US time zone (Pacific (P), Eastern (E), Central (C) and Mountain (M)), hour, minute, year, month/day format, month, day and language. Press ▲ or ▼ to change the setting.
- Press **MODE** to confirm.

NOTE The language options are (E) English, (D) German, (F) French, (I) Italian, and (S) Spanish.

Press **MODE** to choose between the clock with seconds and clock with weekday display modes.

ALARM

To set the alarm:

- Press and hold **ALARM** for 2 seconds.
- Press ▲ / ▼ to set hour / minute.
- Press **ALARM** or **MODE** to confirm. indicates alarm is ON.

To toggle alarms ON / OFF:

- Press **ALARM** to display alarm time.
- Press **ALARM** again to turn alarm ON / OFF.

To silence the alarm:

- Press **SNOOZE** to silence it for 8 minutes.
- OR
- Press any key except **SNOOZE** to turn the alarm off and activate it again after 24 hours.

WEATHER FORECAST

This product forecasts the next 12 to 24 hours of weather within a 30-50 km (19-31 mile) radius based on barometric pressure trend readings.

ICON	DESCRIPTION
	Clear
	Partially Cloudy
	Cloudy
	Rainy

TEMPERATURE

To toggle temperature unit:
Press °C / °F.

To view outdoor sensors temperature readings:
Press CHANNEL.

To auto-scan between sensors:
Press and hold CHANNEL for 2 seconds. Each sensor's data is displayed for 3 seconds.

To end auto-scan:
Press CHANNEL or MEM.

To toggle between current, minimum and maximum records for the selected sensor:
Press MEM repeatedly.

To clear the records:
Press and hold MEM for 2 seconds.

TEMPERATURE AND PRESSURE TREND

The temperature and pressure trend icons are based on recent sensor readings.

RISING	STEADY	FALLING

ICE WARNING

If the channel 1 sensor falls between 3°C to -2°C (37°F to 28°F), *flashes to warn you that the temperature is approaching freezing.

NOTE The warning will automatically stop if the temperature goes outside the ice-warning range.

HI / LO TEMPERATURE ALARM

An alert can be set to sound if the sensor set to channel 1 records above or below a temperature of your choice.

To set alarm ON/OFF:

- Press and hold TEMP HI / LO.
- Use ▲ and ▼ to select high / low temperature alarm. Press TEMP HI / LO to confirm.
- Press ▲ / ▼ to set alarm ON / OFF and press TEMP HI / LO to confirm.
- If alarm has been activated, use ▲ and ▼ to select the temperature.
- Press TEMP HI / LO to confirm.

To silence the hi / lo temperature alarm:

Press any key. The alarm resets automatically and will resound if the hi / lo temperature selected is recorded again.

MOON PHASE

- When calendar is set press ▲ or ▼ to view the moon phase for the next/previous day.
- Press and hold ▲ or ▼ to scan through the years (2001 to 2099).

	New Moon
	Waxing Crescent
	First quarter
	Waxing Gibbous
	Full Moon
	Waning Gibbous
	Last quarter
	Waning Crescent

RESET

Press RESET to return the unit to the default settings.

PRECAUTIONS

This product is engineered to give you years of satisfactory service if you handle it carefully. Here are a few precautions:

- Do not subject the unit to excessive force, shock, dust, temperature or humidity, which may result in malfunction, shorter electronic life span, damaged battery and distorted parts.
- Do not immerse the unit in water. If you spill liquid over it, dry it immediately with a soft, lint-free cloth.

- Do not clean the unit with abrasive or corrosive materials.
- Do not tamper with the unit's internal components. Doing so will invalidate the warranty on the unit and may cause unnecessary damage. The unit contains no user-serviceable parts.
- Only use fresh batteries as specified in the user's instructions. Do not mix new and old batteries.
- Due to printing limitations, the displays shown in this manual may differ from the actual display.
- The contents of this manual may not be reproduced without the permission of the manufacturer.

NOTE The technical specifications for this product and the contents of the user manual are subject to change without notice.

SPECIFICATIONS

TYPE	DESCRIPTION
MAIN UNIT	
L x W x H	77 x 126 x 102 mm (3.14 x 5.14 x 4.16 in)
Weight	183 g (6.46 oz) without batteries
Temperature unit	°C / °F
Temperature range	-5°C to 50°C (23°F to 122°F)
Resolution	0.1°C (0.2°F)
Clock frequency	WWVB-60 (US)
Synchronization	Auto or disabled
Signal frequency	433 MHz
Clock	Auto or manual (disabled)
Humidity range	25% - 95%
Humidity resolution	1%
Memory	Min / Max relative humidity and temperature
Alarm duration	2 minutes
Snooze	8 minutes
Clock display	HH:MM:SS HH:MM: Day of Week
Hour format	12 / 24 hour format
Calendar	MM / DD or DD / MM language selectable: E, F, D, I and S
Power	3 x UM-3 (AA) 1.5 V batteries
REMOTE UNIT	
L x W x H	92 x 60 x 20 mm (3.6 x 2.4 x 0.8 in)
Weight	62 g (2.22 ounces) without battery
Transmission range	30 m (100 ft) unobstructed
Temperature Range	-30°C to 60°C (-22°F to 140°F)
Power	2 x UM-4 (AAA) 1.5 V batteries

NOTE We recommend that you use alkaline batteries with this product for longer usage and lithium batteries in temperatures below freezing.

ABOUT OREGON SCIENTIFIC

Visit our website (www.oregonscientific.com) to learn more about Oregon Scientific products such as digital cameras; MP3 players; children's electronic learning products and games; projection clocks; health and fitness gear; weather stations; and digital and conference phones. The website also includes contact information for our Customer Care department in case you need to reach us, as well as frequently asked questions and customer downloads.

We hope you will find all the information you need on our website, however if you're in the US and would like to contact the Oregon Scientific Customer Care department directly, please visit:
www2.oregonscientific.com/service/default.asp

OR

Call 1-800-853-8883.

For international inquiries, please visit:
www2.oregonscientific.com/about/international.asp

FCC STATEMENT

This device complies with Part 15 of the FCC Rules. Operation is subject to the following two conditions: (1) This device may not cause harmful interference, and (2) This device must accept any interference received, including interference that may cause undesired operation.

WARNING Changes or modifications not expressly approved by the party responsible for compliance could void the user's authority to operate the equipment.

NOTE This equipment has been tested and found to comply with the limits for a Class B digital device, pursuant to Part 15 of the FCC Rules. These limits are designed to provide reasonable protection against harmful interference in a residential installation.

This equipment generates, uses and can radiate radio frequency energy and, if not installed and used in accordance with the instructions, may cause harmful interference to radio communications. However, there is no guarantee that interference will not occur in a particular installation. If this equipment does cause harmful interference to radio or television reception, which can be determined by turning the equipment off and on, the user is encouraged to try to correct the interference by one or more of the following measures:

- Reorient or relocate the receiving antenna.
- Increase the separation between the equipment and receiver.
- Connect the equipment into an outlet on a circuit different from that to which the receiver is connected.
- Consult the dealer or an experienced radio / TV technician for help.

DECLARATION OF CONFORMITY

The following information is not to be used as contact for support or sales. Please call our customer service number (listed on our website at www.oregonscientific.com), or on the warranty card for this product) for all inquiries instead.

We

Name: Oregon Scientific, Inc.
Address: 19861 SW 95th Ave., Tualatin,
Oregon 97062 USA
Telephone No.: 1-800-853-8883

declare that the product

Product No.: BAR686A
Product Name: Wireless Weather Forecaster
with Temperature Display and
Self - Setting Atomic Clock
Manufacturer: IDT Technology Limited
Address: Block C, 9/F, Kaiser Estate,
Phase 1, 41 Man Yue St.,
Hung Hom, Kowloon,
Hong Kong

is in conformity with Part 15 of the FCC Rules. Operation is subject to the following two conditions: 1) This device may not cause harmful interference. 2) This device must accept any interference received, including interference that may cause undesired operation.

Free Manuals Download Website

<http://myh66.com>

<http://usermanuals.us>

<http://www.somanuals.com>

<http://www.4manuals.cc>

<http://www.manual-lib.com>

<http://www.404manual.com>

<http://www.luxmanual.com>

<http://aubethermostatmanual.com>

Golf course search by state

<http://golfingnear.com>

Email search by domain

<http://emailbydomain.com>

Auto manuals search

<http://auto.somanuals.com>

TV manuals search

<http://tv.somanuals.com>