



TREVISO Sleek Weather Station
Model: BAR988HGA / BAR986HGA
USER MANUAL



25

TREVISO Sleek Weather Station Model: BAR988HGA / BAR986HGA

USER MANUAL

CONTENTS

Introduction	3
Product Overview	4
Front View	4
Back View	5
LCD Display	6
Remote Sensor (RTGR328NA)	9
Getting Started	10
Batteries	10
AC Adaptor (Main Unit)	11
Change Settings	11
Remote Sensor	11
Set Up Thermo / Hygro Sensor (RTGR328NA) ...	12
Sensor Data Transmission	13
Search for Sensor	13
Clock and Calendar	13
Atomic Clock	14
Turn Atomic Clock ON / OFF	14
Set Clock	15

Switch Clock Display	15
Alarms	15
Set Daily Alarm	15
Set Pre-Alarm	16
Activate Alarm	16
Snooze	16
Barometer	16
View Barometer Area	17
Select Measurement Unit	17
View Barometer History	17
Bar Chart Display	17
Set Altitude	17
Weather Forecast	18
Weather Forecast Icons	18
UV Measurement - Optional Sensor	18
New Additional UV Features	19
Temperature and Humidity	20
View Temperature and Humidity Area	20
Select Measurement Unit	20
Select Sensor Channel	20
Minimum / Maximum Records	20
Temperature and Humidity Trend	21
Comfort Zone	21
Heat Index	21

EN



Backlight	22
Reset System	22
Safety and Care	22
Warnings	22
Troubleshooting	23
Specifications	23
About Oregon Scientific	25
FCC Statement	25
Declaration of Conformity	26





25

INTRODUCTION

Thank you for selecting the Oregon Scientific™ BAR988HGA / BAR986HGA **TREVISO Sleek Weather Station**. This powerful device bundles time keeping, weather monitoring, indoor and outdoor temperature and humidity readings, barometric trends and altitude adjustment, into a single tool you can use from the convenience of your home.

In this box, you will find:

- Main unit
- Remote sensor (RTGR328NA)
- Optional UV sensor (UVR138A)
- 6V AC adapter
- Batteries

BAR988HGA --- BAR988HGA Main Unit + RTGR328NA Remote Sensor

BAR986HGA --- BAR988HGA Main unit + RTGR328NA Remote Sensor + UVR138A UV Sensor

NOTE The THGR328N (5-Channel) and THGR268 (3-Channel) remote sensors are also compatible with this weather station. Additional sensors are sold separately. Please contact your local **retailer** for more information.

Keep this manual handy as you use your new product. It contains practical step-by-step instructions, as well as technical specifications and warnings you should know.



EN

PRODUCT OVERVIEW

FRONT VIEW

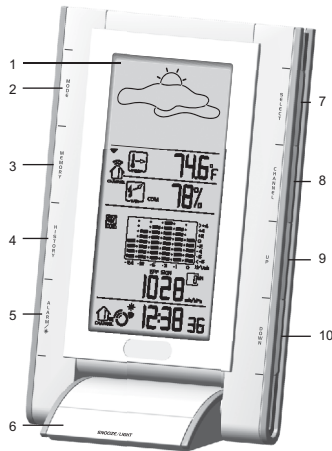

1. LCD display
2. **MODE:** Change settings / display
3. **MEMORY:** View current, maximum and minimum temperature / humidity / UV readings
4. **HISTORY:** View historical barometer and UV readings
5. **ALARM / *:** View alarm status; set alarm
6. **SNOOZE / LIGHT:** Activate 8-minute snooze or backlight
7. **SELECT:** Switch Areas
8. **CHANNEL:** Switch remote sensor display
9. **UP:** Increase setting / activate atomic clock
10. **DOWN:** Decrease setting / deactivate atomic clock



BACK VIEW

25

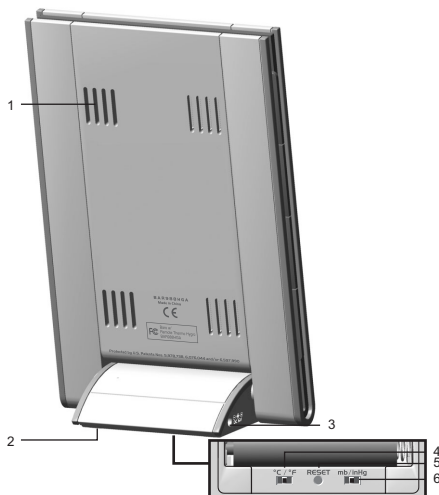

1. Ventilation holes
2. Battery compartment (bottom)
3. AC adaptor socket
4. °C / °F switch (in battery compartment)
5. **RESET** button (in battery compartment)
6. **mb / inHg** switch (in battery compartment)

You can adjust the angle of the clock display as shown below:

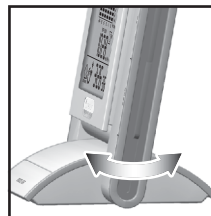

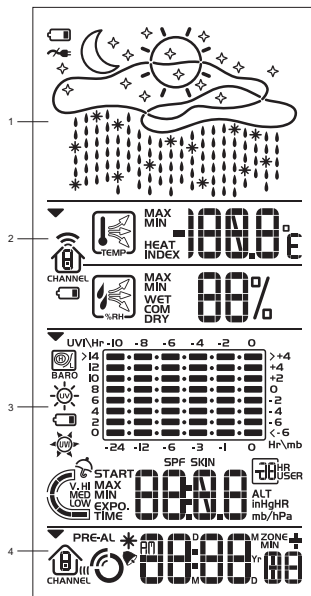

- 1. Weather Forecast Area:** Animated weather forecast
- 2. Temperature / Humidity / Comfort Zone Area:** Readings and trend lines; comfort zone; sensor channel number
- 3. UVI / Barometer Area:** UV level and barometric pressure bar chart; UV Index and barometric readings
- 4. Clock / Alarm / Calendar Area:** Atomic clock; alarms; calendar



25

Weather Forecast Area

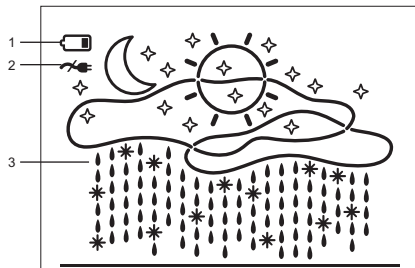

1. Low battery icon for main unit
2. AC adaptor icon - displays when unplugged
3. Weather display

Temperature / Humidity / Comfort Zone Area

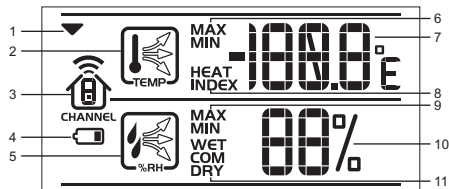

1. Selected Area icon
2. Temperature trend
3. Channel number (1-5) / reception status
4. Low battery icon for remote sensor
5. Humidity trend
6. MAX / MIN temperature
7. Temperature - °C / °F
8. Heat Index
9. MAX / MIN humidity
10. Humidity
11. Comfort levels

UVI / Barometer Area

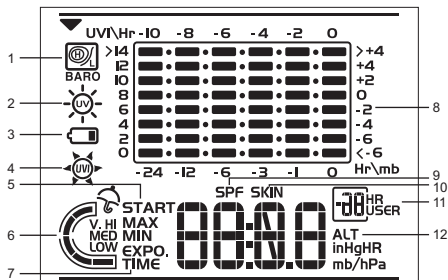

1. Barometric pressure is showing
2. UV is showing
3. Low battery icon for UV sensor
4. UVI value is showing
5. UV exposure time countdown has started
6. UV index level
7. UV exposure time for user
8. Barometer / UV chart
9. SPF applied to user for UV exposure
10. User skin type for UV exposure
11. User no. (for UV Mode) or hour history for UV / Barometric pressure reading
12. Altitude / barometric pressure / UVI reading

8

Clock / Alarm / Calendar Area

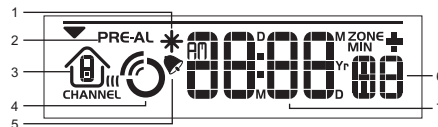

1. Pre-Alarm is set
2. Pre-Alarm display / Pre-Alarm setting
3. Channel with atomic clock reception is locked
4. Atomic clock reception icon
5. Daily Alarm is set
6. Offset time-zone
7. Time / date / calendar



25

REMOTE SENSOR (RTGR328NA)

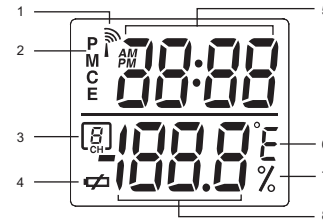
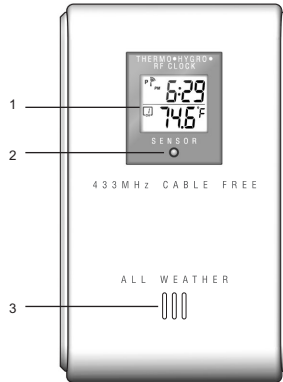

1. Signal reception
2. US time zone
3. Channel number
4. Low battery icon
5. Time
6. Temp (°C or °F)
7. Humidity %
8. Temp / Humidity

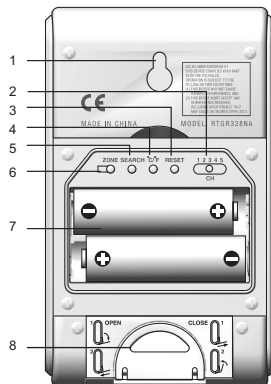

1. Wall mount
2. **CHANNEL** switch (1-5)
3. **RESET**
4. °C / °F
5. **SEARCH**
6. **ZONE**
7. Battery compartment
8. Fold-out stand

GETTING STARTED

BATTERIES

Batteries are supplied with this product:

- Main unit 4 x UM-4 (AAA) 1.5V
- Remote unit 2 x UM-3 (AA) 1.5V

Insert batteries before first use, matching the polarity as shown in the battery compartment. For best results, install batteries in the remote sensor before the main unit. Press **RESET** after each battery change.

To install the main unit batteries:

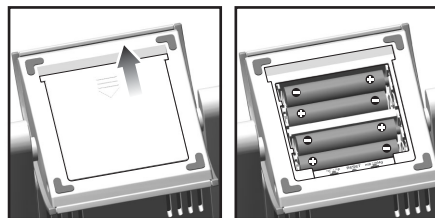

NOTE Do not use rechargeable batteries.

 shows when batteries are low.



NOTE It is recommended that you use alkaline batteries with this product for longer performance.

UNIT	LOCATION
Main	Weather Forecast Area
Remote	Temperature / Humidity Area
UV Sensor	UVI / Barometric Pressure Area

NOTE The UV Sensor is an optional item.

AC ADAPTOR (MAIN UNIT)

The batteries serve as a back-up power supply. For continuous use, please install the AC adaptor at the base of the unit:

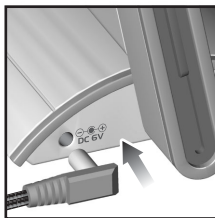

 shows in the Weather Forecast Area when the AC adaptor is not plugged in.

CHANGE SETTINGS

1. Press **SELECT** to switch between Areas. ▼ indicates the selected Area.

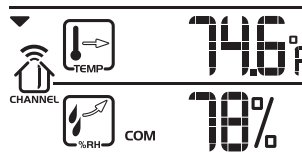

2. Most Areas have alternate display options (for example, Clock / Alarm or Barometer / UVI). Press **MODE** to switch options, or **ALARM** / * to switch between clock and alarm.
3. Press and hold **MODE** for 2 seconds to enter setting mode.
4. Press **UP** or **DOWN** to change settings.
5. Press **MODE** to confirm.

REMOTE SENSOR

This product is shipped with the RTGR328NA Thermo / Hygro Sensor. The main unit can collect data from up to 6 sensors (5 Thermo / Hygro Sensors and 1 UV Sensor). The THGR328N and THGR268 sensors are also compatible with this weather station. (Additional sensors are sold separately. Contact your local **retailer** for more information.)

The RTGR328NA Sensor collects and transmits temperature and humidity information, along with time and date information. Time and date information is obtained by synchronizing with radio broadcasted atomic clock information from the National Institute of Time located in Boulder Colorado. For more information on the Atomic Clock, please visit www.nist.gov

SET UP THERMO / HYGRO SENSOR (RTGR328N)

1. Open the battery compartment with a small Phillips screwdriver.
2. Insert the batteries.
3. Set the channel and radio signal format. The switches are located in the battery compartment.

SWITCH	OPTION
Channel	If you are using more than one sensor, select a different channel for each sensor.

4. Press **RESET**. Then set the temperature unit.

SWITCH	OPTION
Temp	°C / °F

5. Press **ZONE** to select the US time zone (P for Pacific, M for Mountain, C for Central or E for Eastern).
6. Close the battery compartment.

To fold out the stand:

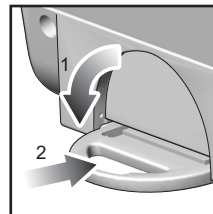

For best results:

- Insert the batteries and select the unit, channel, and US time zone before you mount the sensor.
- Place the sensor out of direct sunlight and moisture.
- Do not place the sensor more than 230 feet (70 meters) from the main (indoor) unit.
- Position the sensor so that it faces the main (indoor) unit, minimizing obstructions such as doors, walls, and furniture.
- Place the sensor in a location with a clear view to the sky, away from metallic or electronic objects.
- Position the sensor close to the main unit during cold winter months as below-freezing temperatures may affect battery performance and signal transmission.



NOTE The transmission range may vary and is subject to the receiving range of the main unit.

You may need to experiment with various locations to get the best results.

SENSOR DATA TRANSMISSION

Data is sent from the sensor(s) every 60 Seconds. The reception icon shown in the Temperature / Humidity Area indicates the status.

ICON	DESCRIPTION
	Main unit is searching for sensors.
	At least 1 channel has been found.
	Sensor 1 is sending data. (The number shows which sensor is selected.)
--- shows in Temp / Humidity Area	The selected sensor cannot be found. Search for the sensor or check batteries.

SEARCH FOR SENSOR

To search for a Thermo / Hygro sensor, press **SELECT** to navigate to the Temperature / Humidity Area. ▼ will show next to the Area. Then, simultaneously press and hold **MEMORY** and **CHANNEL** for 2 seconds.

To search for the UV sensor, press **SELECT** to navigate to the UVI / Barometer Area. ▼ will show next to the Area. Then, press and hold **MEMORY** and **CHANNEL** for 2 seconds. (The UV sensor is an optional item.)

NOTE If the sensor is still not found, check the batteries.

CLOCK AND CALENDAR

This product tracks the time and date based on US atomic clock signals from the RTGR328NA remote sensor, or manual settings that you enter.







ATOMIC CLOCK



The RTGR368NA remote sensor collects time and temperature information and transmits this back to the main unit. The current time and date is received by radio signal from the Atomic Clock broadcast located in Boulder, Colorado. For more information on the Atomic Clock, please visit www.nist.gov

Initial reception takes 2-10 minutes, and is initiated when you first set up the unit, and whenever you press **RESET**. Once complete, the reception icon will stop blinking.



The  icon shown in the Clock Area indicates 2 factors:

- Connection between the main unit and the sensor that collects atomic clock signals ()
- Atomic clock signal reception ()

How these signals work together:

ICON	MEANING
	The unit has contact with the sensor and has synchronized the time.
	The unit has contact with the sensor but the time has not been synchronized.



ICON	MEANING
	The unit has lost contact with the remote sensor but the time is synchronized.
	The unit has lost contact with the remote sensor and the time is not synchronized.
	The unit cannot reach the remote sensor.

NOTE To force a manual search for atomic clock reception, press and hold **SEARCH** on the sensor (RTGR328NA) for 2 seconds.

TURN ATOMIC CLOCK ON / OFF

If you wish to manually set the clock, you must first disable the atomic clock feature. To do this, navigate to the Clock / Alarm Area. Then, press and hold **DOWN** on the main unit for 2 seconds. To enable it, navigate to the Clock / Alarm Area, then press and hold **UP** for 2 seconds.

Atomic clock enabled:





Atomic clock disabled:



SET CLOCK

The BAR988HGA / BAR986HGA and the RTGR368NA should automatically set and update the time, as necessary. However, if you are too far away from an Atomic Clock broadcast signal, or the product is unable to synchronize with the broadcast due to interference, you may need to set the clock manually.

1. Press **SELECT** to navigate to the Clock Area. ▼ will show next to the Area.
2. Press and hold **MODE** for 2 seconds.
3. Select the time zone offset hour (+ / -23 hours), 12 / 24 hour format, hour, minute, year, date / month format, month, date and display language.
4. Press **UP** or **DOWN** to change the setting.
5. Press **MODE** to confirm.

NOTE If no time zone hour offset is set, the time shown will be **Pacific** Time. To change to another US time zone, select an hour offset accordingly. The time zone options and their related hour offset times are **Pacific** (-8), **Mountain** (-7), **Central** (-6) and **Eastern** (-5).

NOTE The language options are (E) English, (F) French, (D) German, (I) Italian, and (S) Spanish. The language you select determines the weekday display.

SWITCH CLOCK DISPLAY

Press **SELECT** to navigate to the Clock Area. ▼ will show next to the Area.

Press **MODE** to toggle between:

- Clock with seconds
- Clock with day
- Clock with time-zone offset
- Calendar

ALARMS

This product has 2 alarms: The Daily Alarm and a Pre-Alarm for snowy weather. The Daily Alarm can be set to go off at the same time every day. The Pre-Alarm sounds only when the Daily Alarm is activated and the recorded temperature from Channel 1 Sensor falls to 35.6°F (2°C) or below.

SET DAILY ALARM

1. Press **SELECT** to navigate to the Clock Area. ▼ will show next to the Area.



2. Press **ALARM** / * to view the alarm. (**AL** will show at the top.)
3. Press and hold **ALARM** / * for 2 seconds.
4. Select the hour and minute. Press **UP** or **DOWN** to change settings.
5. Press **ALARM** / * to confirm.
6. The Daily Alarm icon 🌙 will appear when the alarm is set.

SET PRE-ALARM

The Pre-Alarm can be set to sound 15, 30, 45, or 60 minutes before the Daily Alarm. It will sound whenever the recorded temperature from Channel 1 Sensor falls to 35.6°F (2°C) or below.

For example, if you set the alarm to 7:00 AM, and the Pre-Alarm to 45 minutes, the Pre-Alarm will sound at 6:15 AM provided the outdoor temperature at Channel 1 Sensor is 35.6°F (2°C) or below.

1. Set up and activate the Daily Alarm.
2. Press **ALARM** / * to switch to Pre-Alarm view. (**PRE-AL** will show at the top.)
3. Press and hold **ALARM** / * for 2 seconds.
4. Press **UP** or **DOWN** to select 15, 30, 45 or 60 minutes. This is the amount of time the Pre-Alarm will sound BEFORE the Daily Alarm. The Pre-Alarm is automatically activated when you select a time.



5. Press **ALARM** / * to confirm.

* shows when the Pre-Alarm is set.

NOTE The Daily Alarm will NOT function until the next day if the Pre-Alarm has been triggered. Also, if you deactivate the Daily Alarm, the Pre-Alarm is automatically deactivated.

ACTIVATE ALARM

Navigate to the Clock Area, then press **ALARM** / * to switch to Daily Alarm or Pre-Alarm view. To activate or deactivate the alarm, press **UP** or **DOWN**.

When the alarm time is reached, the backlight will be on for 8 seconds and crescendo alarm will sound for 2 minutes. Press any key (except snooze) to silence the alarm. It will sound at the same time the next day.

SNOOZE

Press **SNOOZE** / **LIGHT** to temporarily disable the alarm for 8 minutes. 🌙 or * will blink while snooze is on.

BAROMETER

This product tracks fluctuations in barometric pressure to provide the weather forecast, and the current and past 24 hours barometric pressure history measurements are recorded by the main (indoor) unit.



25

VIEW BAROMETER AREA

Press **SELECT** to navigate to the Barometer Area.

If  is NOT shown, press **MODE**.

Barometric data is shown in 2 areas at the bottom of the display. The upper area shows a 24-hour bar chart. The lower area shows current and historical readings.

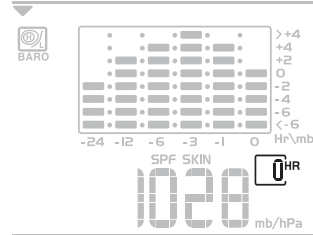
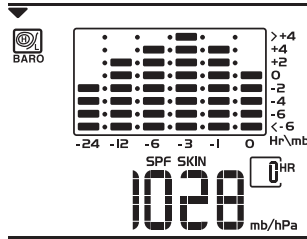

BAR CHART DISPLAY

The bar chart visually shows atmospheric changes from the current hour (0) to 24 hours prior (-24).

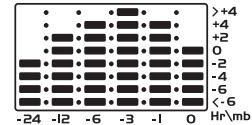

SELECT MEASUREMENT UNIT

Slide the **mb / inHg** switch (in the clock battery compartment), to change the display unit.

VIEW BAROMETER HISTORY

Navigate to the Barometer Area. Then press **HISTORY** repeatedly to scroll through the measurements. The number shown in the HR box indicates how long ago each measurement was taken (e.g. 2 hours ago, 3 hours ago, etc.).

SET ALTITUDE

Set the altitude to match how far above or below sea level you are living. This ensures that the barometric pressure readings are accurate.

1. Navigate to the Barometer Area.
2. Press and hold **HISTORY** for 2 seconds.

3. Press **UP** or **DOWN** to set the altitude in 33-foot increments (-328 ft to 8202 ft).
4. Press **HISTORY** to confirm.

WEATHER FORECAST

This product forecasts the next 12 to 24 hours of weather within a 19-31 mile (30-50 km) radius. The forecast is based on barometric pressure trend readings.



The top area shows an animated icon indicating the forecasted weather.

WEATHER FORECAST ICONS

ICON	DESCRIPTION
<p>Day / Night</p>	Clear
<p>Day / Night</p>	Partly cloudy

18



ICON	DESCRIPTION
	Cloudy
	Rainy
	Snowy

NOTE The night time icon displays from 6 PM to 6 AM. When the Channel 1 Sensor records a temperature of 35.6°F (2°C) or lower, the RAINY icon becomes SNOWY.

UV MEASUREMENT - OPTIONAL SENSOR

The UVR138A Ultra-Violet Radiation Sensor is included with the BAR986HGA and is available as an optional item for the BAR988HGA. The UV sensor gives you the following information at your fingertips:

- 10-hour Ultra-Violet Index (UVI) record.
- Automatic calculation of acceptable UV exposure times based on pre-set user profiles (4 users maximum).
- UVI Danger Alert when UV Index reaches unsafe levels.



UV data is shown in the same area as the Barometer. Press **SELECT** to navigate to the Barometer Area, then press **MODE** to display the UV icon ☀ and data.

NOTE Refer to the UVR138A User Manual for more information and see below to learn about the new additional UV features.

NEW ADDITIONAL UV FEATURES

UV EXPOSURE TIME COUNTDOWN

To set the exposure time countdown you need set to the Skin Type and Sun Protection Factor (SPF) as follows:

1. Press **SELECT** to navigate to the Barometer Area, then press **MODE** to select the UV display.

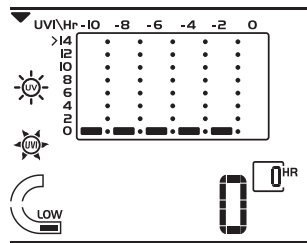

2. Press **CHANNEL** to select user 1-4.
3. Press and hold **MODE** for 2 seconds to enter the Skin Type Setting Mode of the selected user.
4. Press **UP** or **DOWN** to choose 1 of the 4 skin type settings. Then press **MODE** to confirm and enter the SPF Set Up Mode.
5. Press **UP** or **DOWN** to increase or decrease the **SPF** value. Then press **MODE** to confirm and enter the UV Exposure Time Countdown Setting Mode.
6. Press **UP** or **DOWN** to enable or disable countdown. Press **MODE** to exit the UV Exposure Time Countdown Mode and start the exposure time countdown. The remaining user UV exposure time will display and the **START** will flash.
7. When the countdown has reached "0", an alarm will sound for 2 minutes. Press any button to turn the alarm off. The **STOP TIME** icon will flash for 2 minutes even if you have stopped the alarm sound.

MAXIMUM / MINIMUM MEMORY FOR UVI

To view the maximum and minimum memory for UVI:

1. Press **SELECT** to navigate to the Barometer Area.
2. Press **MODE** to select the UV display.
3. Press **MEMORY** to show maximum, minimum and current UVI readings.
4. Press and hold **MEMORY** for 2 seconds to clear the UVI memory.

NOTE The UV sensor must be activated before you try and set the additional features. Please refer to the UVR138A User Manual for more information.

TEMPERATURE AND HUMIDITY

The weather station can display the following information from any of the 5 remote sensors:

- Current, minimum, and maximum temperatures and relative humidity percentages.
- Comfort level indicator and trend line (rising, falling, or steady).

Data is collected and displayed approximately every 60 seconds.

VIEW TEMPERATURE AND HUMIDITY AREA

Press **SELECT** to navigate to the Temperature and Humidity Areas.

Temperature data is given at the top; Humidity is below.

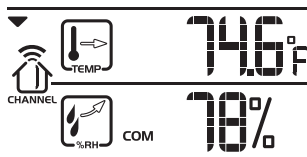

20

SELECT MEASUREMENT UNIT

Slide the °C / °F switch (inside the clock battery compartment), to the setting you want.

SELECT SENSOR CHANNEL

Press **CHANNEL** to switch between sensors 1-5.



The house icon shows the selected remote sensor.

- To auto-scan between sensors, press and hold **CHANNEL** for 2 seconds. Each sensor's data will be displayed for 3 seconds.
- To end auto-scan, press **CHANNEL** or **MEMORY** with the Temperature / Humidity Area selected.

NOTE If you select a sensor that collects only temperature data, the humidity will not be shown.

MINIMUM / MAXIMUM RECORDS

- Press **MEMORY** repeatedly to view current, maximum and minimum records for the selected sensor.
- To clear the records, press and hold **MEMORY** for 2 seconds. A beep will sound to confirm that the memory has been cleared.

**TEMPERATURE AND HUMIDITY TREND**

The trend lines are shown next to the temperature and humidity readings.

TREND	RISING	STEADY	FALLING
TEMPERATURE			
HUMIDITY			

COMFORT ZONE

The Comfort Zone indicates how comfortable the climate is, based on current temperature and humidity measurements.

ZONE	TEMPERATURE	HUMIDITY
WET	Any	>70%
COM	68-77°F (20-25°C)	40-70%
DRY	Any	<40%

NOTE This information is shown in the Humidity Area when the current measurement is displayed.

HEAT INDEX

The Heat Index advises 4 levels of warning if the temperature is high.

DANGER CATEGORY	TEMPERATURE	
	°F	°C
Extreme Danger	>130	>54.5
Danger	105-130	40.5-54.4
Extreme Caution	90-105	32.2-40.5
Caution	80-90	26.6-32.2

To display the Heat Index:

1. Press **SELECT** to navigate to the Temperature Area. ▼ will show next to the Area.
2. Press **MODE** to reach the Heat Index display.
3. Press **CHANNEL** to select the desired channel.

NOTE If the temperature is below 80°F / 26°C, or the desired channel is not working, the Heat Index will display "NA".

BACKLIGHT

Press **SNOOZE / LIGHT** to illuminate the backlight for 8 seconds.

RESET SYSTEM

The **RESET** button is located at the bottom of the unit. Press **RESET** when you change the batteries and whenever performance is not behaving as expected (for example, unable to establish radio frequency link with remote unit or ~~radio-controlled~~ clock).

NOTE When you press **RESET**, all settings will return to default value, and you will lose all stored information.

SAFETY AND CARE

Clean the product with a slightly damp cloth and alcohol-free, mild detergent. Avoid dropping the product or placing it in a high-traffic location.

WARNINGS

This product is designed to give you years of service if handled properly. Oregon Scientific will not be responsible for any deviations in the usage of the device from those specified in the user instructions or any unapproved alterations or repairs of the product. Observe the following guidelines:

- Never immerse the product in water. This can cause electrical shock and damage the product.
- Do not subject the main unit to extreme force, shock, or fluctuations in temperature or humidity.
- Do not tamper with the internal components.
- Do not mix new and old batteries or batteries of different types.
- Do not use rechargeable batteries with this product.
- Remove the batteries if storing this product for a long period of time.
- Do not scratch the LCD display.

NOTE The technical specification of this product and contents of this user guide are subject to change without notice. Images not drawn to scale.

**TROUBLESHOOTING**

PROBLEM	SYMPTOM	REMEDY
Barometer	Strange readings	Set altitude / unit (→ 17)
Calendar	Strange date / month	Change language (→ 15)
Clock	Cannot adjust clock	Disable atomic clock (→ 14)
	Cannot auto-synch	1. Adjust batteries (→ 10) 2. Press RESET (→ 22) 3. Manually activate atomic clock (→ 14)
Temp	Shows "LLL" or "HHH"	Temperature is out-of-range
Remote sensor	Cannot locate remote sensor	Check batteries (→ 12)

SPECIFICATIONS**Main Unit Dimensions**

L x W x H	4.72 x 3.39 x 7.40 inches (120 x 86 x 188 mm)
Weight	0.83 lbs (376 grams) without battery

Remote Unit Dimensions

L x W x H	2.76 x 0.96 x 4.57 inches (70 x 24.5 x 116 mm)
Weight	0.24 lbs (108 grams) without battery

Temperature

Unit	°F or °C
Indoor Range	23 °F to 122 °F (-5 °C to 50 °C)
Outdoor Range	-4 °F to 140 °F (-20 °C to 60 °C)
Resolution	0.2 °F (0.1 °C)
Comfort	68 °F to 77 °F (20 °C to 25 °C)
Memory	Min / Max

Relative Humidity

Range	25% to 95%
Resolution	1%



EN

Comfort 40% to 70%
Memory Min / max

Barometer

Unit mb / hPa or inHg
Resolution 1 mb (0.03 inHg)
Altitude -328 to 8202 feet
(-100 to 2500 meters)
Display Sunny (day / night),
partly cloudy (day /
night), cloudy, rainy,
snowy



Remote Unit (RTGR328NA)

RF frequency 433 MHz
Range Up to 230 feet (70 meters)
with no obstructions
Transmission Approx. every 1 minute
Channel No. 1, 2, 3, 4 or 5
Unit °C or °F

Atomic Clock

Synchronization Auto or disabled
Clock display HH:MM:SS
Hour format 12hr AM / PM or 24hr

Calendar DD / MM or MM / DD;
Day of the week in 1 of
5 languages (E, G, F, I, S)

Alarm Daily & Pre-Alarm;
2-minute crescendo
Snooze 8-minute snooze

Power

Main Unit

Power adapter 6V AC adapter
Batteries 4 x UM-4 (AAA) 1.5V

Thermo / Hygro Remote Unit

Batteries 2 x UM-3 (AA) 1.5V

NOTE It is recommended that you use alkaline
batteries with this product for longer performance.



ABOUT OREGON SCIENTIFIC

Visit our website (www.oregonscientific.com) to learn more about Oregon Scientific products such as digital cameras; MP3 players; children's electronic learning products and games; projection clocks; health and fitness gear; weather stations; and digital and conference phones. The website also includes contact information for our customer care department in case you need to reach us, as well as frequently asked questions and customer downloads.

We hope you will find all the information you need on our website, however if you'd like to contact the Oregon Scientific Customer Care department directly, please visit:

www2.oregonscientific.com/service/support

OR

Call 949-608-2848 in the US.

For international enquiries, please visit:

www2.oregonscientific.com/about/international/default.asp

FCC STATEMENT

This device complies with Part 15 of the FCC Rules. Operation is subject to the following two conditions:

 This device may not cause harmful interference, and this device must accept any interference received, including interference that may cause undesired operation.

WARNING Changes or modifications to this unit not expressly approved by the party responsible for compliance could void the user's authority to operate the equipment.

NOTE This equipment has been tested and found to comply with the limits for a Class B digital device, pursuant to Part 15 of the FCC Rules. These limits are designed to provide reasonable protection against harmful interference in a residential installation. This equipment generates, uses and can radiate radio frequency energy and, if not installed and used in accordance with the instructions, may cause harmful interference to radio communications.

However, there is no guarantee that interference will not occur in a particular installation. If this equipment does cause harmful interference to radio or television reception, which can be determined by turning the equipment off and on, the user is encouraged to try to correct the interference by one or more of the following measures:

EN

- Reorient or relocate the receiving antenna.
- Increase the separation between the equipment and receiver.
- Connect the equipment into an outlet on a circuit different from that to which the receiver is connected.
- Consult the dealer or an experienced radio / TV technician for help.

DECLARATION OF CONFORMITY

The information below is not to be used as contact for support or sales. Please call our customer service number (listed on our website at www.oregonscientific.com, or on the warranty card for this product) for all inquiries instead.

We

Name: Oregon Scientific, Inc.
Address: 19861 SW 95th Place,
Tualatin, Oregon 97062 USA
Telephone No.: 1-800-853-8883
Fax No.: 1-503-684-8883

declare that the product

Product No.: BAR988HGA / BAR986HGA
Product Name: **TREVISO Sleek Weather Station**
Manufacturer: IDT Technology Limited
Address: Block C, 9/F, Kaiser Estate,
Phase 1, 41 Man Yue St.,
Hung Hom, Kowloon,
Hong Kong

is in conformity with Part 15 of the FCC Rules. Operation is subject to the following two conditions:



This device may not cause harmful interference.
This device must accept any interference received, including interference that may cause undesired operation.



© 2004 Oregon Scientific. All rights reserved.
086-00000-000



Free Manuals Download Website

<http://myh66.com>

<http://usermanuals.us>

<http://www.somanuals.com>

<http://www.4manuals.cc>

<http://www.manual-lib.com>

<http://www.404manual.com>

<http://www.luxmanual.com>

<http://aubethermostatmanual.com>

Golf course search by state

<http://golfingnear.com>

Email search by domain

<http://emailbydomain.com>

Auto manuals search

<http://auto.somanuals.com>

TV manuals search

<http://tv.somanuals.com>