



Advanced Weather Station with Wireless Sensor Set & Mounting Package Model: WMR100N / WMR100NA

USER MANUAL

CONTENTS

- Introduction**..... 1
- Packaging Contents**..... 1
 - Base station 1
 - Wind Sensor / Temperature & Humidity Sensor..... 1
 - Rain Gauge 2
 - Assembly Parts 2
- Accessories - Sensors**..... 2
- Overview**..... 2
 - Front View 2
 - Back View 3
 - LCD Display 3
 - Wind Sensor 4
 - Rain Gauge 4
 - Outdoor Temperature / Humidity Sensor 5
- Getting Started**..... 5
 - Set Up Remote Wind Sensor 5
 - Set Up Remote Temperature / Humidity Sensor 5
- Remote Unit Assembly**..... 5
 - Alternative Set Up: Remote Wind Sensor on Existing Pole 6
 - Alternative Set Up: Temperature / Humidity Sensor Mounted Separately..... 7
 - Set Up Rain Gauge 7
- Set Up Base Station** 8
- Base Station**..... 8
 - Change Display / Setting 8
- Clock Reception** 8
- Clock / Calendar** 9
- Clock Alarm**..... 9
- Moon Phase** 9
- Auto Scanning Function** 9
- Weather Forecast** 9
- Temperature and Humidity** 10
 - Temperature and Humidity Trend 10
 - Comfort Level 10
- Wind Direction / Speed** 10
- UVI / Barometer / Rainfall**..... 11
 - UV Index 11
 - Barometer 12
 - Rainfall 12
- Weather Alarms** 12
- Set Up Software (First time use)** 12
 - Additional step for Windows Vista users only 12
 - Install software 13
- Disable Sleep Mode**..... 13
 - To disable sleep mode on computer 13 (Windows XP)
 - To disable sleep mode on computer 13 (Windows Vista)
- Upload data to PC software**..... 13
- Software updates**..... 14
- Backlight** 14
- Reset**..... 14
- Specifications** 14
- Precautions** 15
- About Oregon Scientific** 15
- EU Declaration of Conformity** 15
- FCC Statement**..... 16

INTRODUCTION

Thank you for selecting the Oregon Scientific™ Weather Station (WMR100N / WMR100NA).

The base station is compatible with other sensors. To purchase additional sensors, please contact your local retailer.



Sensors with this logo are compatible with this unit.

NOTE Please keep this manual handy as you use your new product. It contains practical step-by-step instructions, as well as technical specifications and warnings you should know about.

PACKAGING CONTENTS

BASE STATION



1 x Base Station



1 x USB cable



1 x 6V adapter



4 x AA UM-3 1.5V batteries

WIND SENSOR / TEMPERATURE & HUMIDITY SENSOR



1 x Wind Sensor (1 x Wind Vane Above and 1 x Anemometer Below)







1 x Aluminium pole







2 x AA UM-3 1.5V batteries











2 x AAA UM-4 1.5V batteries

		 4 x Screws (Type A)
1 x Temperature / Humidity Sensor casing	1 x Temperature / Humidity Sensor	 1 x sensor connector

RAIN GAUGE

	 1 x Filter	 4 x Screws (Type C)
1 x Rain Collector	 2 x AA UM-3 1.5V batteries	 6 x Washers

ASSEMBLY PARTS

 1x Vertical Attachment Bracket	 1 x Cone- Shaped End	 1 x Horizontal Attachment Bracket
 1 x Bottom Pole	 1 x Mid Pole	 1x Top Pole
 2 x Round U- bolts	 2 x Rectangular Base Legs	 3 x Eye pins

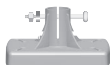

1 x Versatile Base (Wall or Ground Fixable)

ACCESSORIES - SENSORS

This product can work with up to 10 sensors at any one time to capture outdoor temperature, relative humidity or UV readings in various locations.

Optional wireless remote sensors such as those listed below can be purchased separately. For more information, please contact your local retailer.*

- Solar Panel STC800 connectable to Wind Sensor and Temperature / humidity sensor
- Thermo-hygro THGR800 (3-Ch)
- Thermo-hygro THGR810 (10-Ch)
- UV UVN800

* *Features and accessories will not be available in all countries.*

OVERVIEW

FRONT VIEW



1. **MEMORY / ON / OFF:** Read the max / min memory record; Activate / deactivate alarms
2. **ALARM:** View and set alarms for barometer, temperature, humidity, rainfall and wind speed
3. **MODE:** Switch between the different display modes / settings
4. **Rotating dial:** Rotate left or right to increase or decrease the values of the selected reading
5. **SELECT:** Switch between the different areas



BACK VIEW



1. AC adapter socket
2. **RESET:** Returns unit to default settings
3. **SEARCH:** Searches for sensors or for the radio-controlled clock signal
4. **UNIT:** Selects unit of measurement
5. Battery compartment
6. WMR100N only – **EU / UK** radio signal
7. USB connector

LCD DISPLAY

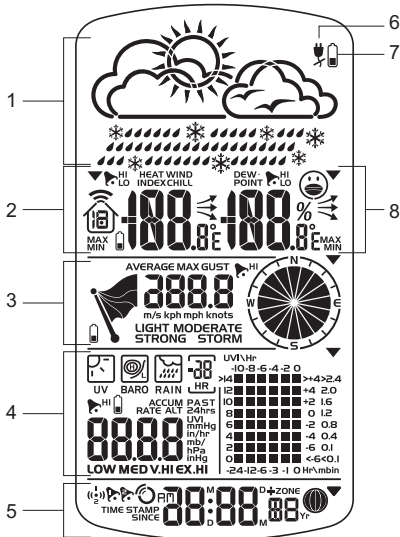

1. Weather Forecast Area
2. Temperature / Heat Index / Wind Chill Area
3. Wind Speed / Wind Direction Area
4. UVI / Barometer / Rainfall Area
5. Clock / Alarm / Calendar / Moon Phase Area
6. AC adapter icon - displays when unplugged
7. Low battery icon for base station
8. Humidity / Dew Point Area

Temperature / Heat Index / Wind Chill Area

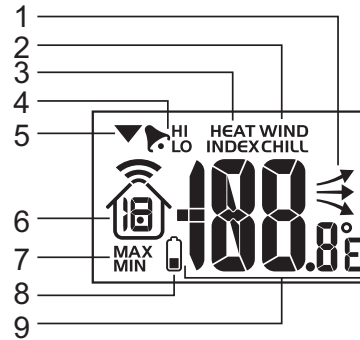

1. Temperature trend
2. Wind Chill level - temperature is showing
3. Heat Index level - temperature is showing
4. HI / LO temperature, HI Heat Index and LO Wind Chill alarms are set
5. Selected area icon
6. Indoor / Outdoor channel temperature and humidity is displayed
7. MAX / MIN temperature
8. Outdoor sensor battery is low
9. Temperature (°C / °F)

Wind Speed / Wind Direction Area

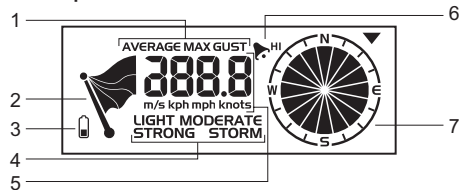

1. Wind speed levels: AVERAGE / MAX / GUST
2. Wind speed level indicator
3. Outdoor wind sensor battery is low
4. Wind speed level description
5. Gust wind or wind speed reading (m / s, kph, mph or knots)
6. HI gust wind alarm is set
7. Wind direction display

UVI / Barometer / Rainfall Area

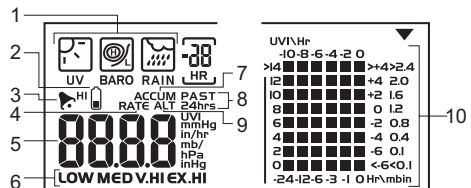

1. UVI / barometer / rainfall readings is showing
2. Outdoor UV / rain sensor battery is low
3. UV / barometer / rainfall alarm is set

4. Rain rate is showing
5. UVI / barometric pressure (mmHg, inHg or mb / hPa)/ rainfall readings (in / hr or mm / hr)
6. UVI level indicator
7. Accumulated rainfall is showing
8. Past 24hrs rainfall is showing
9. Altitude is showing
10. UVI / barometric pressure / rainfall historical bar chart display

Clock / Alarm / Calendar / Moon Phase Area

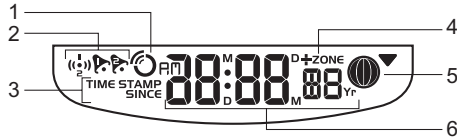

1. Clock radio reception
2. Alarm 1 and 2 are displayed and set
3. Timestamp is displayed
4. Offset time zone
5. Moon phase
6. Time / date / calendar

Humidity / Dew Point Area

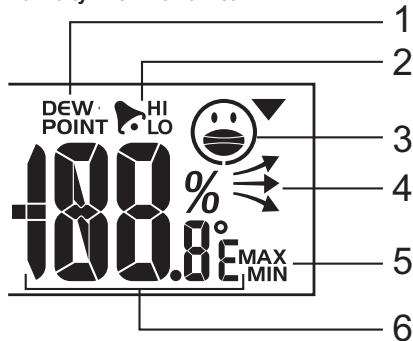

1. Dew point level - Temperature is showing
2. HI / LO humidity and Dew Point alarms are set
3. Comfort levels
4. Humidity trend
5. MAX / MIN humidity
6. Humidity reading

WIND SENSOR

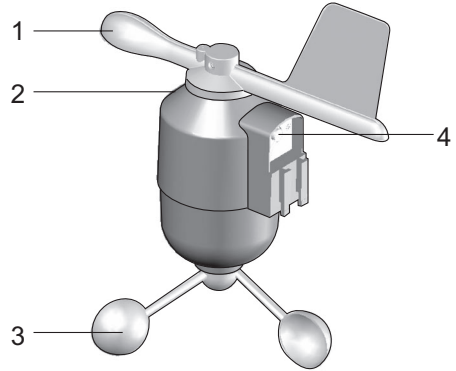

1. Wind direction
2. Wind vane casing
3. Anemometer
4. Solar power socket

RAIN GAUGE

Base and funnel:

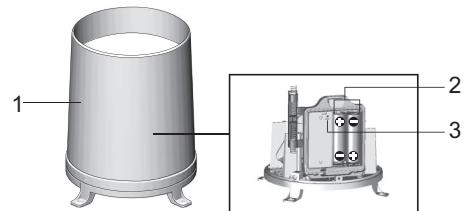

1. Rain gauge
2. Battery compartment
3. RESET button

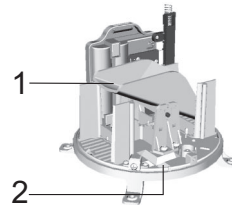

1. Funnel
2. Indicator

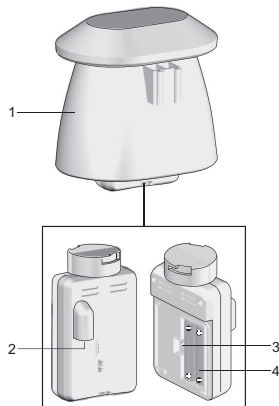
**OUTDOOR TEMPERATURE / HUMIDITY SENSOR**

1. Temperature / humidity sensor casing
2. Solar power socket
3. **RESET** button
4. Battery compartment

GETTING STARTED**SET UP REMOTE WIND SENSOR**

The wind sensor takes wind speed and direction readings.

The sensor is battery operated. It is capable of transmitting data to the base station wirelessly within an approximate operating range of 100 meters (328 feet).

IMPORTANT Ensure that the wind sensor is pointing North to enable it to record accurate readings.

NOTE The sensor should be positioned in an open area away from trees or other obstructions.

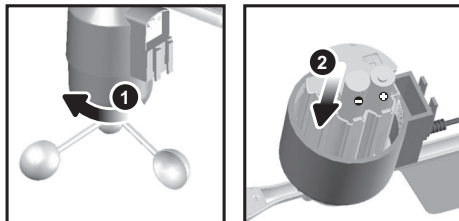
To insert batteries:

1. Unscrew the anemometer from the wind sensor carefully.
2. Insert batteries matching the polarities (+ / -) and replace the anemometer. Press **RESET** after each battery change.

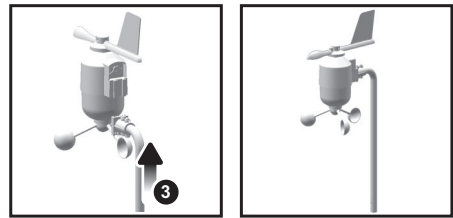

3. Slide wind vane onto the end of the plastic attachment located on the aluminium pole.

NOTE Use alkaline batteries for longer usage and consumer grade lithium batteries in temperatures below freezing.

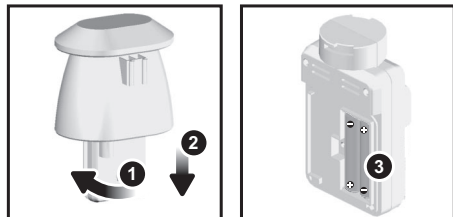
SET UP REMOTE TEMPERATURE / HUMIDITY SENSOR

1. Holding sensor, twist and click to the left.
2. Pull sensor away from casing.
3. Insert batteries matching the polarities (+ / -). Press **RESET** after each battery change.

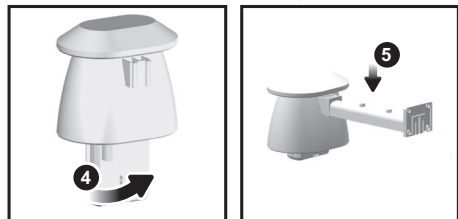

4. Insert sensor into the casing, twist and click to the right to secure.
5. Slide temperature and humidity sensor onto the smaller end of the sensor connector.

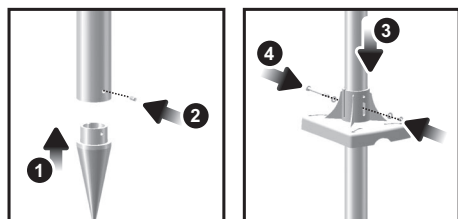
REMOTE UNIT ASSEMBLY

1. Insert the cone-shaped end into the pole.
2. Using 2 screws, fix it firmly into place.

3. Insert the versatile plastic base into the pole. Align the holes of the pole with the holes of the plastic base.
4. Secure the plastic base by inserting the screw and screwing it tightly into the holes of the plastic base and pole.

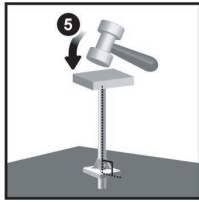

IMPORTANT The sensor should be positioned in an open area away from trees or other obstructions.

5. Hammer pole (cone end down) into the ground at the desired spot until versatile plastic base is level with the ground.

TIP Place a block of wood between the pole and the hammer to prevent damage to the pole.

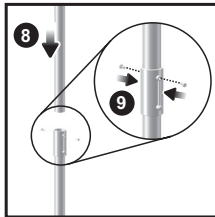
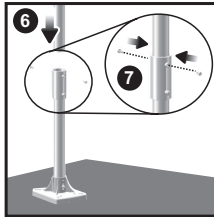

6. Assemble middle pole on top of the bottom one.
7. Using two screws, fix it firmly into place.
8. Assemble top pole on top of the middle one.
9. Using two screws, fix it firmly into place.

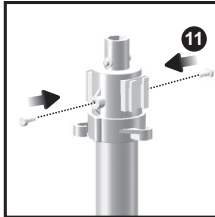
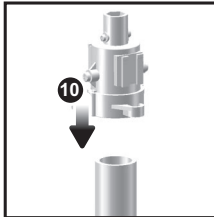

10. Slide the vertical attachment bracket on top of the top pole.
11. Using two screws, fix it firmly into place.

To mount the temperature / humidity sensor:

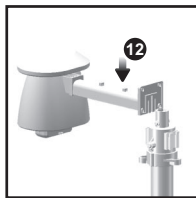

12. Slide outdoor sensor onto vertical attachment bracket.

To mount the wind sensor:

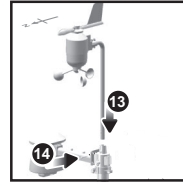

13. Insert the wind vane into the attachment bracket.
14. Screw aluminium pole firmly into place.

IMPORTANT For best results, point the wind vane North.

Securing the assembled remote unit:

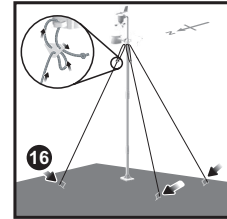
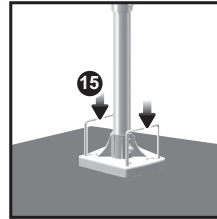

15. Insert the 2 rectangular base legs through the holes of the versatile base and hammer down.
16. Using the string, tie a knot on the eye pins. Hammer each eye pin into the ground at a 90° angle.

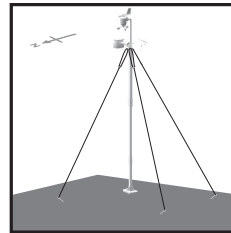

IMPORTANT Using the fasteners, tighten the string. To tighten, pull fastener down. To loosen, thread the string up through the fastener eyelets.

ALTERNATIVE SET UP: REMOTE WIND SENSOR ON EXISTING POLE

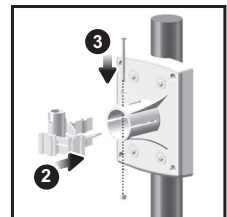
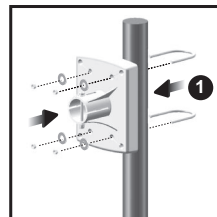

1. Secure the plastic base onto existing pole with U-bolts, washers and bolts.
2. Insert the horizontal attachment bracket into the base.
3. Using a screw, fix firmly into place.

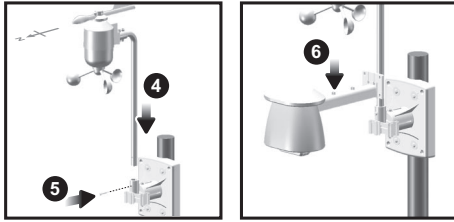

4. Insert wind sensor into the top of the bracket.
5. Using screws, fix aluminium pole firmly into place.
6. Slide outdoor sensor onto bracket.

IMPORTANT For best results, point the wind vane North.



ALTERNATIVE SET UP: TEMPERATURE / HUMIDITY SENSOR MOUNTED SEPARATELY

1. Insert 4 type A screws into the holes of the sensor connector. Screw firmly into place, i.e., fence.

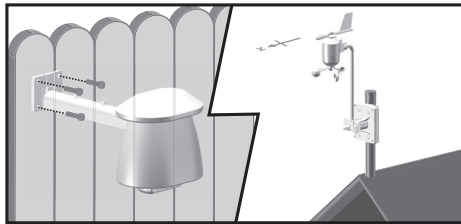

SET UP RAIN GAUGE

The rain gauge collects rain and takes readings of rainfall rate and the total rainfall over a period of time. The sensor can remotely transmit data to the base station.

The base station and rain gauge should be positioned within an effective range: about 100 meters (328 feet) in an open area.

The rain gauge should be mounted horizontally about 1 meter (3 feet) from the ground in an open area away from trees or other obstructions to allow rain to fall naturally for an accurate reading.

To set up the Rain Gauge:

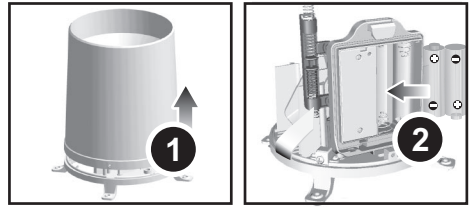

1. Remove screws and slide the cover off in an upwards motion.
2. Insert the batteries (2 x UM-3 / AA), matching the polarities (+ / -). Press **RESET** after each battery change.

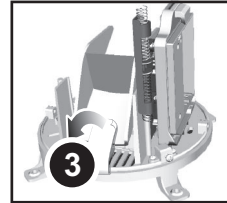

3. Remove the fibre tape.

To ensure a level plane:

Put a few drops of water on the cross at the base of the funnel to check the horizontal level.

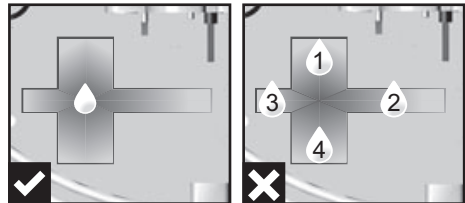

Water will pool to the center of the cross when the rain gauge is level.

If water remains on 1-4, the gauge is not horizontal.

If necessary, adjust the level using the screw.

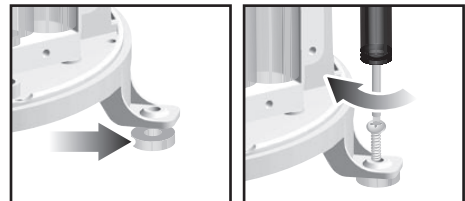

NOTE For best results, ensure the base is horizontal to allow maximum drainage of any collected rain.

SET UP BASE STATION

NOTE Install batteries in the remote sensor before the base station matching the polarities (+ and -).

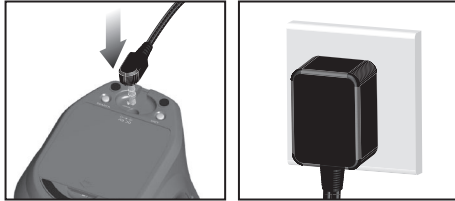

For continuous use, please install the AC adapter. The batteries are for back-up use only.

NOTE Make sure the adapter is not obstructed and is easily accessible to the unit.

NOTE The base station and adapter should not be exposed to wet conditions. No objects filled with liquid, such as vases, should be placed on the base station and adapter.

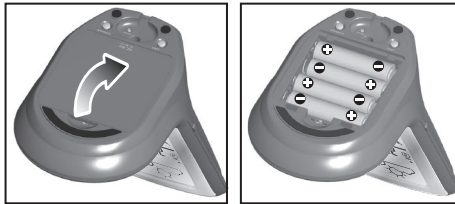

Install the base station batteries (4 x UM-3 / AA) matching the polarity + and -. Press **RESET** after each battery change.

NOTE Do not use rechargeable batteries. It is recommended that you use alkaline batteries with this product for longer performance.

NOTE Batteries should not be exposed to excessive heat such as sunshine or fire.

The battery icon indicator  may appear in the following areas:

AREA	MEANING
Weather Forecast Area	Battery in the base station is low.  will show when AC adapter is disconnected.
Temperature / Heat Index / Wind Chill Area	The displayed channel indicates the outdoor sensor for which battery is low.
Wind Speed / Wind Direction Area	Battery in the wind sensor is low.
UVI / Barometer / Rainfall Area	Battery in the UV / Rain sensor is low.

BASE STATION

CHANGE DISPLAY / SETTING

To change the display and settings, use the following buttons on the rotating dial: **SELECT**, **MEMORY** /  **ON / OFF, MODE** and **ALARM**.

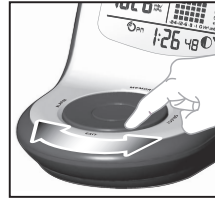

In addition, the **UNIT** and **SEARCH** buttons located at the bottom of the base station allows pre-setting of the remote sensor channels and the measurement units for display.

TIP To exit from the setting mode, push any button. Alternatively, the base station will automatically exit after 30 seconds.

CLOCK RECEPTION

This product is designed to synchronize its calendar clock automatically once it is brought within range of a radio signal:

WMR100N:

- EU: DCF-77 signal: within 1500 km (932 miles) of Frankfurt, Germany.
- UK: MSF-60 signal: within 1500 km (932 miles) of Anthon, England.



WMR100NA:

- WWVB-60 signal: within 3200km (2000 miles) of Fort Collins Colorado.

WMR100N only - slide the **EU / UK** switch to the appropriate setting based on your location. Press **RESET** whenever you change the selected setting.

The reception icon will blink when it is searching for a signal. If the radio signal is weak it can take up to 24 hours to get a valid signal reception.

 indicates the status of the clock reception signal.

ICON	MEANING
	Time is synchronized. Receiving signal is strong
	Time is not synchronized. Receiving signal is weak

To enable (and force a signal search) / disable the clock radio reception (clock synchronization):

1. Press **SELECT** to navigate to the Clock / Calendar / Alarm Area.  will show next to the Area.
2. Press and hold **SEARCH**.

 appears when it is enabled.



NOTE For best reception, the base station should be placed on a flat, non-metallic surface near a window in an upper floor of your home. The antenna should be placed away from electrical appliances and not be moved around when searching for a signal.

CLOCK / CALENDAR

To manually set the clock:

(You only need to set the clock and calendar if you have disabled the clock radio reception).

1. Press **SELECT** to navigate to the Clock Area. ▼ will show next to the Area.
2. Press and hold **MODE** to change the clock setting. The setting will blink.
3. Rotate the dial left or right to decrease or increase the setting value.
4. Press **MODE** to confirm.
5. Repeat steps 1 to 5 to set the time zone offset hour (+ / -23 hours), 12 / 24 hour format, hour, minute, year, date / month format, month, date and weekday language.

NOTE If you enter +1 in the time zone setting, this will give you your regional time plus 1 hour.

If you are in the US (WMR100NA only) set the clock to:

- 0 for Pacific time +1 for Mountain time
- +2 for Central time +3 for Eastern time.

NOTE The weekday is available in English, German, French, Italian or Spanish.

To change the clock display:

1. Press **SELECT** to navigate to the Clock Area. ▼ will show next to the Area.
2. Press **MODE** to toggle between:
 - Clock with Seconds
 - Clock with Weekday
 - Calendar

CLOCK ALARM

The clock has 2 alarms that can be set to sound with a beep.

ICON	MEANING
	Alarm 1 or 2 is displayed
	Alarm 1 or 2 is activated
No icons	No alarm is set

To set an alarm:

1. Press **SELECT** to navigate to the Clock Area. ▼ will show next to the Area.
2. Press **ALARM** to toggle between alarm 1 () and alarm 2 () display.
3. When you've selected the alarm you wish to change, press and hold **ALARM**. The alarm setting will blink.
4. Rotate the dial left or right to change the setting.
5. Press **ALARM** to confirm.

To activate / deactivate an alarm:

1. Press **SELECT** to navigate to the Clock Area. ▼ will show next to the Area.
2. Press **ALARM** to toggle between alarm 1 () and alarm 2 ()
3. Press **MEMORY / ON / OFF** to activate or deactivate the alarm. or appears when the alarm is activated.

MOON PHASE

The Calendar must be set for this feature to work (see **Clock / Calendar** section).

	New Moon		Full Moon
	Waxing Crescent		Waning Gibbous
	First quarter		Third quarter
	Waxing Gibbous		Waning Crescent

AUTO SCANNING FUNCTION

To activate the outdoor temperature and humidity auto-scan function:

1. Press **SELECT** to navigate to the Temperature or Humidity Area. ▼ will show next to the Area.
2. Press and hold **MODE** to activate auto-scan. The temperature and humidity display will scroll from indoor to ch1 through to ch10.
3. Press **MEMORY / ON / OFF** or **MODE** or **ALARM** to stop the auto-scan.

NOTE Channel 1 is used for the outdoor temperature and humidity sensor. Additional temperature and humidity sensors can use other channels.

WEATHER FORECAST

This product forecasts the next 12 to 24 hours of weather within a 30-50 km (19-31 mile) radius.

Weather Forecast Area

ICON	DESCRIPTION
	Sunny
	Partly cloudy
	Cloudy
	Rainy
	Snowy



TEMPERATURE AND HUMIDITY

The weather station displays indoor and outdoor readings for:

1. Current, minimum and maximum temperatures and relative humidity.
2. Comfort level indicator and trend line.
3. Heat index, wind chill and dew point level.

The weather station can connect up to 10 remote sensors.

NOTE Channel 1 is dedicated for outdoor temperature and humidity.

-  shows which remote sensor's data you are viewing.
-  appears when indoor data is displayed.

The timestamp records the date and time when storing the temperature and humidity readings in memory.

To select the temperature measurement unit:

Press **UNIT** (at the bottom of the base station) to select °C / °F.

NOTE The unit of all temperature related displays will be changed simultaneously.

To view temperature (Current temperature, Heat Index and Wind Chill):

1. Press **SELECT** to navigate to the Temperature Area. ▼ will show next to the Area.
2. Rotate the dial left or right to select the channel.
3. Press **MODE** repeatedly to toggle between the different displays.
4. Press **MEMORY / ▲ ON / OFF** to select MAX / MIN display.

NOTE To view wind chill, ensure channel 1  is selected.

To view humidity (Humidity, Dew point):

1. Press **SELECT** to navigate to the Humidity Area. ▼ will show next to the Area.
2. Rotate the dial left or right to select the channel.
3. Press **MODE** repeatedly to toggle between the different displays.
4. Press **MEMORY / ▲ ON / OFF** to select MAX / MIN display.

Data required	Area located	Channels supported	Type of memory
Current Temperature	Temperature	Indoor and 1-10 outdoor	MAX
Heat Index			MIN
Wind Chill			1 only
Humidity	Humidity	Indoor and 1-10 outdoor	MAX
Dew Point			MIN
			MAX
			MIN

The timestamp is displayed accordingly in the Clock Area.

To clear the memories and timestamp for the temperature, heat index, wind chill, humidity and dew point readings:

In the Temperature or Humidity Area, press and hold **MEMORY / ▲ ON / OFF** to clear the readings.

To change the high / low temperature, heat index, wind chill, humidity and dew point alarms:

1. In the Temperature or Humidity Area, press **ALARM** repeatedly to toggle between high / low alarms for temperature, heat index, wind chill, humidity and dew point readings.
2. Press and hold **ALARM** to enter the alarm setting.
3. Rotate the dial left or right to set the desired values.
4. Press **ALARM** to confirm the setting.

To activate / deactivate the high / low temperature, heat index, wind chill, humidity and dew point alarms:

1. In the Temperature or Humidity Area, press **ALARM** repeatedly to select the desired alarm.
2. Press **MEMORY / ▲ ON / OFF** to activate or deactivate the alarm.

NOTE The dew point advises at what temperature condensation will form. The wind chill factor is based on the combined effects of temperature and wind speed.

TEMPERATURE AND HUMIDITY TREND

The trend lines are shown next to the temperature and humidity readings. The trend is shown as follows:

RISING	STEADY	FALLING
		

COMFORT LEVEL

The Comfort Zone icon indicates how comfortable the climate is based on current temperature and humidity measurements:

COMFORTABLE	NEUTRAL	UNCOMFORTABLE
		

WIND DIRECTION / SPEED

The base station provides wind speed and wind direction information.

To read the wind direction find the compass point the ▼ is pointing to.



The timestamp records the date and time when storing the wind speed readings.

**To select the wind speed unit:**

Press **UNIT** (at the bottom of the base station) to switch between:

- Metres per second (**m / s**)
- Kilometers per hour (**kph**)
- Miles per hour (**mph**)
- Knots (**knots**)

288.8
m/s kph mph knots

The wind level is shown by a series of icons:

ICON	LEVEL	DESCRIPTION
	N/A	<2 mph (<4km/h)
	Light	2-8 mph (3~13 km/h)
	Moderate	9-25 mph (~14-41 km/h)
	Strong	26-54 mph (~42-87 km/h)
	Storm	>55 mph (>88 km/h)

To display the AVERAGE and GUST wind:

1. Press **SELECT** to navigate to the Wind Speed and Wind Direction Area. will show next to the Area.
2. Press **MODE** to toggle between AVERAGE and GUST wind readings.

To display the maximum speed and direction for gust wind:

In the Wind Speed and Wind Direction Area, press **MEMORY / ON / OFF** to toggle between wind speed / MAX GUST wind readings. The timestamp is displayed accordingly in the Clock Area.

To clear the memories and timestamp for the wind readings:

In the Wind Speed and Wind Direction Area, press and hold **MEMORY / ON / OFF** to clear the readings.

To change the high gust wind speed alarm:

1. In the Wind Speed and Wind Direction Area, press and hold **ALARM** to enter the high gust wind alarm setting.
2. Rotate the dial left or right to set the desired values.
3. Press **ALARM** to confirm the settings.

To activate / deactivate the high gust wind speed alarm:

1. In the Wind Speed and Wind Direction Area, press **ALARM** repeatedly to select the desired alarm.
2. Press **MEMORY / ON / OFF** to activate or deactivate the alarm.

UVI / BAROMETER / RAINFALL

The weather station works with one UV sensor and one rain gauge. The station is capable of storing and displaying the hourly history data for the last 10 hours

of UV index, and 24 hours of rainfall and barometric pressure readings.

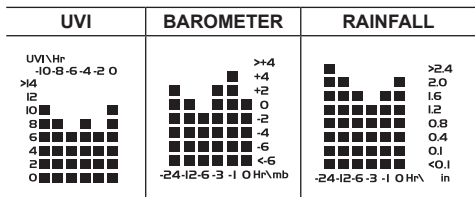

The bar chart display shows the current and historical data for the UV index, barometric pressure and rainfall readings.

To view the UV / Barometer / Rainfall readings:

1. Press **SELECT** to navigate to the UV / Barometer / Rainfall Area. will show next to the Area.
2. Press **MODE** to toggle between UVI / Barometer / Rainfall readings. The corresponding icon will appear:

UVI	BAROMETER	RAINFALL

3. Rotate the dial left or right to view the historical data for the selected area. The corresponding historical readings are showing.

NOTE The number shown in the HR icon indicates how long ago each measurement was taken (e.g. 2 hours ago, 3 hours ago, etc.).

To select the measurement unit for the barometer or rainfall readings:

In the UV / Barometer / Rainfall Area, press **UNIT** (at the bottom of the base station) to switch between:

- Barometer: Millimeters of mercury (**mmHg**), inches of mercury (**inHg**), millibars per hectopascal (**mb / hpa**).
- Rainfall: Millimeters (**mm**), inches (**in**), inches per hour (**in / hr**) or millimeters per hour (**mm / hr**).

UV INDEX**The UV index levels are as follows:**

UV INDEX	DANGER LEVEL	ICON
0-2	Low	LOW
3-5	Moderate	MED
6-7	High	HI
8-10	Very high	V.HI
11 and above	Extremely high	EX.HI

To change the high UV alarm:

1. In the UV / Barometer / Rainfall Area and UVI reading display. Press and hold **ALARM** to enter the high UV alarm setting.

2. Rotate the dial left or right to set the desired values.
3. Press **ALARM** to confirm the settings.

To activate / deactivate the high UV alarm:

1. In the UV / Barometer / Rainfall Area and UVI reading display, press **ALARM** repeatedly to select the desired alarm.
2. Press **MEMORY** /  **ON / OFF** to activate or deactivate the alarm.

BAROMETER

To change the barometer alarm:

1. In the UV / Barometer / Rainfall Area and Barometer reading display, press and hold **ALARM** to enter the Barometer alarm setting.
2. Rotate the dial left or right to set the desired values.
3. Press **ALARM** to confirm the settings.

To activate / deactivate the barometer alarm:

1. In the UV / Barometer / Rainfall Area and Barometer reading display, press **ALARM** repeatedly to select the desired alarm.
2. Press **MEMORY** /  **ON / OFF** to activate or deactivate the alarm.

To set the altitude level compensation for the Barometer readings:

1. In the UV / Barometer / Rainfall Area and Barometer reading display. Press and hold **MODE** to enter the altitude setting.
2. Rotate the dial left or right to set the desired values.
3. Press **MODE** to confirm the setting.

RAINFALL

To view the current hour, accumulated or last 24 hours rainfall history:

In the UV / Barometer / Rainfall Area and Rainfall reading display, press **MEMORY** /  **ON / OFF** repeatedly to toggle between current, past 24 hours or accumulated rainfall. The clock line will change to display the start time when the accumulated rainfall is displayed. The icon **SINCE** appears and the start date is showing.

To toggle between rainfall & rain rate display:

In the UV / Barometer / Rainfall Area and Rainfall reading display, press and hold **MODE**.

To reset the accumulated rainfall and timestamp:

In the UV / Barometer / Rainfall Area and Rainfall reading display. Press and hold **MEMORY** /  **ON / OFF** to reset the accumulated rainfall to '0' and to set the timestamp to current date and time.

To change the HI rainfall rate alarm:

1. In the UV / Barometer / Rainfall Area and Rainfall reading display, press and hold **ALARM** to enter the Rainfall alarm setting.
2. Rotate the dial left or right to set the desired values.

3. Press **ALARM** to confirm the settings.

To activate / deactivate the HI rainfall rate alarm:

1. In the UV / Barometer / Rainfall Area and Rainfall reading display, press **ALARM** repeatedly to select the desired alarm.
2. Press **MEMORY** /  **ON / OFF** to activate or deactivate the alarm.

WEATHER ALARMS

Weather alarms are used to alert you of certain weather conditions. Once activated, the alarm will go off when a certain criterion is met.

Alarms can be set for:

- Indoor and outdoor high / low temperatures, dew point and High / Low humidity
- High Heat Index
- High Gust Wind
- Low wind chill
- High UV
- Pressure drop
- High rain rate

See the relevant section for how to set the alarm.

To silence any alarm: Press any button or rotate the dial.

SET UP SOFTWARE (FIRST TIME USE)

The base station is capable of connecting to a PC computer using the USB connection. The software can read the latest weather data collected from the base station.

PC system requirements

The minimum system requirements for use of the software is:

- Operating system: Microsoft Windows XP SP2 or Vista
- Processor: Pentium 4 or above
- RAM: Min. 512MB
- Hard disk free space: Min. 512MB
- Screen Display Area: 1024 x 768 pixels (recommended)

ADDITIONAL STEP FOR WINDOWS VISTA USERS ONLY

** For Windows XP users, please go straight to **Install Software** section.*

IMPORTANT You must follow the below instructions **before** installing software.

Determine status of UAC (User Account Control):

1. Click on  Start.
2. In context menu, scroll to **Settings** and select **Control Panel**.
3. Double click the **User Account (and Family Safety)**.



- Double click on **Change your Windows password**. (If you chose the **Control Panel classic** link from left hand column in step 2, skip this step).
- In **Turn User Account On or Off** screen, identify if UAC option is enabled / on (ticked) or disabled / off (un-ticked).

NOTE We highly recommend disabling this option for seamless operation of the Weather OS software.

To Turn User Account Off:

- Deselect the UAC option by un-ticking the box (click once).
- Click **OK**.
- In **You must restart your computer** dialogue box, click **Restart now**.

INSTALL SOFTWARE

- Insert provided CD into disk drive.
- Run CD software.
- Setup Wizard** dialogue box will appear and guide you through the installation process.
If you have Windows Vista and User Account Control is ON (ticked),
 - In **Select Installation Folder** dialogue box, next to **Folder** text box (C:\Program Files\Oregon Scientific\Weather OS), click **Browse**.
 - To select a new location to save the program, select **C:\Users\admin**. {Or click **C:** Drive, subfolder **Users**, subfolder **admin**.}
 - Click on (**Create New Folder**) icon.
 - Type **OS Weather** and click **OK**.
 - In **User Account Control** dialogue box, click **Allow**.
 - Continue with installation process.
- During installation, **Microsoft Visual C++ Redistributable Setup** dialogue box may appear. Select **Repair** and click **Next**.
- Once Setup has been successfully completed, click **Finish**, then **Close**.
- After successful installation, double click on desktop shortcut.
- Click **Display** in **Oregon Weather Station** dialogue box.

DISABLE SLEEP MODE

To allow for continuous data updates, ensure Sleep Mode on computer is disabled.

TO DISABLE SLEEP MODE ON COMPUTER (WINDOWS XP)

- Right click on **Desktop**.
- In context menu, click on **Properties**.
- Click on **Screen Saver** tab in the **Display Properties** dialogue box.
- Click on **Power** located at the bottom half of dialogue box.

- In new dialogue box **Power Options Properties**, click on **Power Schemes** tab.
- In **Settings for Timers off (Presentation) power scheme** section, under **System Standby** option, choose **Never** in drop-down list.
- Click **Apply** and then click **OK**.
- Previous window will return. Click **OK** to confirm and exit.

TO DISABLE SLEEP MODE ON COMPUTER (WINDOWS VISTA)

- Right click on **Desktop**.
- In context menu, click on **Personalize**.
- Click on **Screen Saver** link in the **Personalize appearance and sounds** dialogue box.
- Click on **Change Power Settings** located at the bottom half of window.
- Select **High Performance** and click **Change plan settings** link.
- Click **Change advanced power settings** link.
- Click on next to **Sleep**, in sub menu, click on next to **Hibernate after**.
- Click **Setting** link and select **Never** in drop-down list.
- Click **Apply** and then **OK**.

UPLOAD DATA TO PC SOFTWARE

NOTE The USB is only used for uploading weather data. It cannot be used for charging battery power.

- After successful installation, double click on desktop shortcut.
- Click **Display** in **Oregon Weather Station** dialogue box.
- You will be prompted to select model number. Please select your model in the drop-down list and refer to the image next to your selection to confirm it is the correct model.

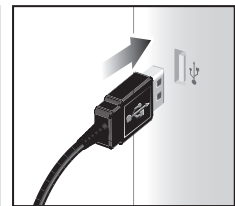
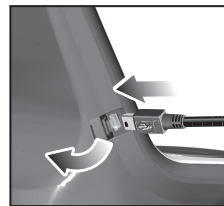

- Plug one end of the USB cable into the base station's USB port and the other end into the PC's USB port.
- Uploading will start immediately.

NOTE This product should be supplied by an identical USB port complying with the requirements of Limited Power Source.

To learn more about how to utilize the functions available on the software, please refer to PC Software Manual,

downloadable from the software webpage.

IMPORTANT You must first successfully install software to access the PC Software Manual.

1. In the PC software homepage, click on **MENU** located at the top right hand corner of software main webpage.
2. Select **HELP** from drop-down list. This will redirect you to a new webpage. Click on  **PC Software Manual**.

SOFTWARE UPDATES

As we continually strive for improvement, the software will be updated from time to time.

If there is a new version, the moment PC is connected to the internet, a dialogue box informing of available software will appear.

1. Click **OK**.
2. After a few moments, **File Download - Security Warning** dialogue box will appear. Click **Run**.
3. In the **Internet Explorer - Security Warning**, click **Run**.
4. Follow steps 3 - 7 from **Install Software** section.

BACKLIGHT

Press any button or rotate the dial to activate the backlight.

RESET

Press **RESET** to return to the default settings.

SPECIFICATIONS

BASE STATION

Dimensions (L x W x H)	143 x 89 x 165 mm (5.6 x 3.5 x 6.5 inches)
Weight	300 g (10.58 oz) without battery

INDOOR BAROMETER

Barometer unit	mb/hPa, inHg and mmHg
Measuring range	700 – 1050mb/hPa
Accuracy	+/- 10 mb/hPa
Resolution	1mb (0.0 inHg)
Altitude setting	Sea level User setting for compensation
Weather display	Sunny, Partly Cloudy, Cloudy, Rainy and Snowy

Memory	Historical data and bar chart for last 24hrs
--------	--

INDOOR TEMPERATURE

Temp. unit	°C / °F
Displayed range	0°C to 50°C (32°F to 122°F)

Operating range	-30°C to 60°C (-4°F to 140°F)
Accuracy	0°C - 40°C: +/- 1°C (+/- 2.0°F) 40°C - 50°C: +/- 2°C (+/- 4.0°F)
Comfort	20°C to 25°C (68°F to 77°F)
Memory	Current, Min and Max temp. Dew Point w/ Min and Max
Alarm	Hi / Lo

INDOOR RELATIVE HUMIDITY

Displayed range	2% to 98%
Operating range	25% to 90%
Resolution	1%
Accuracy	25% - 40%: +/- 7% 40% - 80%: +/- 5% 80% - 90%: +/- 7%
Comfort	40% to 70%
Memory	Current, Min and Max
Alarm	Hi / Lo

RADIO-CONTROLLED / ATOMIC CLOCK

Synchronization	Auto or disabled
Clock display	HH:MM:SS
Hour format	12hr AM/PM or 24hr
Calendar	DD/MM or MM/DD
Weekday in 5 languages	(E, G, F, I, S)
Battery	4 x UM-3 (AA) 1.5V batteries AC adapter 6V

REMOTE WIND SENSOR UNIT

Dimensions (L x W x H)	178 x 76 x 214 mm (7 x 3 x 8.4 inches)
Weight	100 g (3.53 oz) without battery
Wind speed unit	m/s, kph, mph, knots
Speed accuracy	2 m/s ~ 10 m/s (+/- 3 m/s) 10 m/s ~ 56 m/s (+/- 10%)
Direction accuracy	16 positions
Transmission of wind speed signal	Approx. every 14 seconds
Memory	Max speed gust
Battery	2 x UM-3 (AA) 1.5V batteries

OUTDOOR TEMPERATURE / HUMIDITY UNIT

• RELATIVE TEMPERATURE

Dimensions (L x W x H)	115 x 87 x 118 mm (4.5 x 3.4 x 4.6 inches)
Weight	130 g (4.59 oz) without battery
Temp. unit	°C / °F
Displayed range	-50°C to 70°C (-58°F to 158°F)



Operating range	-30°C to 60°C (-4°F to 140°F)
Accuracy	-20°C - 0°C: +/- 2°C (+/- 4.0°F) 0°C - 40°C: +/- 1°C (+/- 2.0°F) 40°C - 50°C: +/- 2°C (+/- 4.0°F) 50°C - 60°C: +/- 3°C (+/- 6.0°F)
Comfort	20°C to 25°C (68°F to 77°F)
Memory	Current, Min and Max temp. Dew Point w/ Max and Min Wind chill temp. and min

• RELATIVE HUMIDITY

Displayed range	2% to 98%
Operating range	25% to 90%
Resolution	1%
Accuracy	25% - 40%: +/- 7% 40% - 80%: +/- 5% 80% - 90%: +/- 7%
Comfort	40% to 70%
Memory	Current, Min and Max
Battery	2 x UM-4 (AAA) 1.5V batteries

RF TRANSMISSION

RF frequency	433MHz
Range	Up to 100 meters (328 feet) with no obstructions
Transmission	Approx. every 60 seconds
No. of Channel	1 for Wind/ Rain/ UV and 10 for Temp. / Humidity

REMOTE RAIN GAUGE

Dimensions (L x W x H)	114 x 114 x 145 mm 4.5 x 4.5 x 5.7 inches
Weight	241 g (8.50 oz lbs) without battery
Rainfall unit	Mm/hr and in/hr
Range	0 mm/hr - 9999 mm/hr
Resolution	1 mm/hr
Accuracy	< 15 mm/hr: +/- 1 mm 15 mm to 9999 mm: +/- 7%
Memory	Past 24hrs, hourly and accumulated from last memory reset
Battery	2 x UM-3 (AA) 1.5V

PRECAUTIONS

- Do not subject the unit to excessive force, shock, dust, temperature or humidity.
- Do not cover the ventilation holes with any items such as newspapers, curtains etc.
- Do not immerse the unit in water. If you spill liquid

over it, dry it immediately with a soft, lint-free cloth.

- Do not clean the unit with abrasive or corrosive materials.
- Do not tamper with the unit's internal components. This invalidates the warranty.
- Only use fresh batteries. Do not mix new and old batteries.
- Images shown in this manual may differ from the actual display.
- When disposing of this product, ensure it is collected separately for special treatment and not as household waste.
- Placement of this product on certain types of wood may result in damage to its finish for which Oregon Scientific will not be responsible. Consult the furniture manufacturer's care instructions for information.
- The contents of this manual may not be reproduced without the permission of the manufacturer.
- Do not dispose old batteries as unsorted municipal waste. Collection of such waste separately for special treatment is necessary.
- Please note that some units are equipped with a battery safety strip. Remove the strip from the battery compartment before first use.

NOTE The technical specifications for this product and the contents of the user manual are subject to change without notice.

NOTE Features and accessories will not be available in all countries. For more information, please contact your local retailer.

ABOUT OREGON SCIENTIFIC

Visit our website (www.oregonscientific.com) to learn more about Oregon Scientific products. If you're in the US and would like to contact our Customer Care department directly, please visit: www2.oregonscientific.com/service/support.asp



For international inquiries, please visit: www2.oregonscientific.com/about/international.asp

EU DECLARATION OF CONFORMITY

Hereby, Oregon Scientific, declares that this Advanced Weather Station with Wireless Sensor Set & Mounting Package (models: WMR100N / WMR100NA) is in compliance with the essential requirements and other relevant provisions of Directive 1999/5/EC. A copy of the signed and dated Declaration of Conformity is available on request via our Oregon Scientific Customer Service.



COUNTRIES RTTE APPROVAL COMPLIED

All EU countries, Switzerland  and Norway 

FCC STATEMENT

This device complies with Part 15 of the FCC Rules. Operation is subject to the following two conditions: (1) This device may not cause harmful interference, and (2) This device must accept any interference received, including interference that may cause undesired operation.

WARNING Changes or modifications not expressly approved by the party responsible for compliance could void the user's authority to operate the equipment.

NOTE This equipment has been tested and found to comply with the limits for a Class B digital device, pursuant to Part 15 of the FCC Rules. These limits are designed to provide reasonable protection against harmful interference in a residential installation.

This equipment generates, uses and can radiate radio frequency energy and, if not installed and used in accordance with the instructions, may cause harmful interference to radio communications. However, there is no guarantee that interference will not occur in a particular installation. If this equipment does cause harmful interference to radio or television reception, which can be determined by turning the equipment off and on, the user is encouraged to try to correct the interference by one or more of the following measures:

- Reorient or relocate the receiving antenna.
- Increase the separation between the equipment and receiver.
- Connect the equipment into an outlet on a circuit different from that to which the receiver is connected.
- Consult the dealer or an experienced radio / TV technician for help.

DECLARATION OF CONFORMITY

The following information is not to be used as contact for support or sales. Please visit our website at www2.oregonscientific.com/service for all enquiries.

We

Name: Oregon Scientific, Inc.
 Address: 19861 SW 95th Ave., Tualatin,
 Oregon 97062 USA
 Telephone No.: 1-800-853-8883

declare that the product

Product No.: WMR100N / WMR100NA
 Product Name: Advanced Weather Station
 with Wireless Sensor Set &
 Mounting Package
 Manufacturer: IDT Technology Limited
 Address: Block C, 9/F, Kaiser Estate,
 Phase 1, 41 Man Yue St.,
 Hung Hom, Kowloon,
 Hong Kong

is in conformity with Part 15 of the FCC Rules. Operation is subject to the following two conditions: 1) This device may not cause harmful interference. 2) This device must accept any interference received, including interference that may cause undesired operation.

Free Manuals Download Website

<http://myh66.com>

<http://usermanuals.us>

<http://www.somanuals.com>

<http://www.4manuals.cc>

<http://www.manual-lib.com>

<http://www.404manual.com>

<http://www.luxmanual.com>

<http://aubethermostatmanual.com>

Golf course search by state

<http://golfingnear.com>

Email search by domain

<http://emailbydomain.com>

Auto manuals search

<http://auto.somanuals.com>

TV manuals search

<http://tv.somanuals.com>