



## Owner's Manual

### Oricom C1000

1.8 GHz DECT Wireless Conference Phone

#### TABLE OF CONTENTS

IMPORTANT SAFETY INFORMATION .....	4
GETTING STARTED .....	7
Contents Of Pack .....	7
Oricom C1000 DECT Wireless Conference Phone .....	8
LCD Display on the POD .....	10
Phone Key .....	11
Basic Steps For Installation .....	12
Charging the POD .....	12
To Ensure Better Performance .....	12
BASIC OPERATIONS .....	13
Standby .....	13
Answering Calls .....	13
Making Calls .....	14
Traditional Dialing .....	14
Predialing .....	15
Redialing .....	16
Traditional Dialing .....	16
Predialing .....	16
Phonebook Dialing .....	18
Traditional Dialing .....	18
Predialing .....	20
Services Dialing .....	21
Service Centre Quick Access .....	22
Things you can do during a call .....	23
Adjust Speaker Volume .....	23
Mute Call .....	23
Change Dial Tone .....	24
Send Flash Signal .....	24
Dialing Extra Digits .....	24
Dialing from Phonebook Record .....	25
Displaying User Phone Number .....	26
Ringer Volume .....	27
Adjusting Ringer Volume .....	27
Ringer On/Off Shortcut .....	27
Storing Numbers in the Phonebook .....	28

Programming.....	29
Start Programming .....	29
Ringer Melody .....	30
Recall Duration .....	31
Users Phone Number .....	32
Network Services Number .....	33
Service Centre Number .....	34
Returning to factory Default Setting .....	35
Additional Features .....	36
Call Recording .....	36
Out of Range Warning .....	36
Paging .....	36
Low Battery .....	37
QUICK REFERENCE GUIDE .....	38
TROUBLE SHOOTING .....	40
TECHNICAL DATA .....	40
FACTORY DEFAULT VALUES.....	40
WALL – MOUNTING .....	41
Warranty Information.....	42

## IMPORTANT SAFETY INFORMATION

Please read the safety instructions before first use of this product.

- Read and understand all instructions.
- Follow all warnings and instructions marked on the product.
- Unplug this product from the power socket before cleaning. Do not use liquid cleaners or aerosol cleaners. Use a damp cloth for cleaning.
- Do not use this product near water, for example, near a bathtub, washbowl, kitchen sink, or laundry tub, in a wet basement, or near a swimming pool.
- Do not place this product on an unstable cart, stand, or table. The product may fall, causing serious damage to the product.
- Slots and openings in the cabinet and the back or bottom are provided for ventilation, to protect it from overheating, these openings must not be blocked or covered.
- This product should never be placed near or over a radiator or heat register. This product should not be placed in a built-in installation unless proper ventilation is provided.
- Use only the he type of power source indicated on the marking label of the power adaptors. If you are not sure of the type of power supply to your building, consult your local power company.
- Do not overload wall outlets and extension cords as this can result in the risk of fire or electric shock.
- Never push objects of any kind into this product through cabinet slots as they may touch dangerous voltage points or short out parts that could result in a risk of fire or electric shock. Never spill liquid of any kind on the product.
- To reduce the risk of electric shock, do not disassemble this product. Take the product to a qualified serviceman when it requires repair work or service. Opening or removing covers may expose you to dangerous voltages or other risks. Incorrect reassembly can cause electric shock during subsequent use.
- Unplug this product from the wall outlet and remove battery and refer servicing to qualified service personnel under the following conditions:
  - a. When the power supply cord or plug is damaged or frayed.
  - b. If liquid has been spilled into the product.
  - c. If the product does not operate normally by following the operating instructions.
  - d. If the product has been dropped or the cabinet has been damaged.
  - e. If the product exhibits a distinct change in performance.

- Do not use your telephone during an electrical storm thunderstorm as it is possible to get an electric shock. Refer to information contained in Telstra White pages directory.
- Do not use this product to report a gas leak in the vicinity of the leak.
- Do not use this product near intensive care medical equipment or by persons with pacemakers.
- Due to the radio signals between base station and POD, wearers of hearing aids may experience interference in the form of a humming noise.
- This product can interfere with electrical equipment such as answering machines, TV sets, radios, computers and microwave ovens if placed too close.
- This telephone is not designed for making emergency telephone calls when the mains power fails. Always have a corded telephone available to be able to make and receive calls to emergency services.

## CAUTION

- *To reduce the risk of fire or injury to persons, read and follow these instructions:*

### BATTERIES

- Disconnect the product from wall outlet when replacing the battery pack.
- Use only the battery pack type listed in the Owner's Manual. Do not use lithium batteries.
- Do not dispose of the battery pack in a fire, as they can explode. Check with local codes for battery disposal regulations.
- Do not open or mutilate the battery pack. Released electrolyte is corrosive and can cause damage to the eyes or skin. It can be toxic if swallowed.
- Avoid contact with rings, bracelets, keys or other metal objects when handling the battery pack. These objects could short out the batteries or cause the conductor to overheat resulting in burns.
- Do not attempt to recharge the battery pack by heating it. Sudden release of battery electrolyte can cause burns or irritation to the eyes or skin.

## CAUTION







- Observe the proper polarity, or direction, of any battery. Reverse insertion of the battery pack can cause charging, and can result in leakage or explosion.
- Remove the battery pack if you do not plan to use the product for several months at a time. The batteries could leak over that time.
- Discard any "dead" battery packs as soon as possible because they are likely to leak into the product.
- Do not store this product or the battery pack in a high temperature area. Battery packs stored in a freezer or refrigerator should be protected from condensation during storage and defrosting. Battery packs should be stabilized at room temperature before using.
- Your battery pack is rechargeable and can be recycled once it outlives its usefulness. Depending upon your local and state law, it might be illegal to dispose of this battery into a municipal waste system. Check with your local solid waste company for more information on your recycling options for the battery pack.

## SAVE THESE INSTRUCTIONS FOR FUTURE REFERENCE

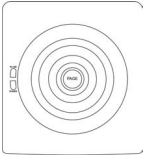
## GETTING STARTED

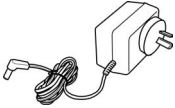
### Contents Of Pack

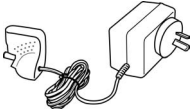
This package should contain the following:

<b>Base</b> 	<b>POD</b> 
<b>Base Adaptor</b> 	<b>Battery</b> 
<b>Charging Adaptor for POD</b> 	
<b>Telephone Line cord and plug</b> 	<b>User's Guide</b> 

If any of these items are missing, please contact the dealer were you purchased this product.

## Oricom C1000 DECT Wireless Conference Phone

### POD

#### Clear / Number

During dialing/programming, press to clear previous digit; or press and hold to delete the entire string of numbers.

Press once to exit programming/phonebook/redial review. Press and hold to exit to Standby from programming mode.

Press to display your own phone number when the phone is in use.

#### Volume control

Press increase/decrease ringer volume.

Press to increase/decrease speaker volume during a call.

#### Phone Book

Press for phonebook dialing during a call.

Press and hold to program phonebook entries and for phonebook dialing

#### Service

Press to access network service number

#### Redial / Program

Press to dial last number dialed.

Press and hold to access programming functions

#### Recall

Press to send recall signal during a call

#### Phone

Press to seize the line or to hang up at the end of a call

#### Mute

Press to mute or un-mute the microphones during a call

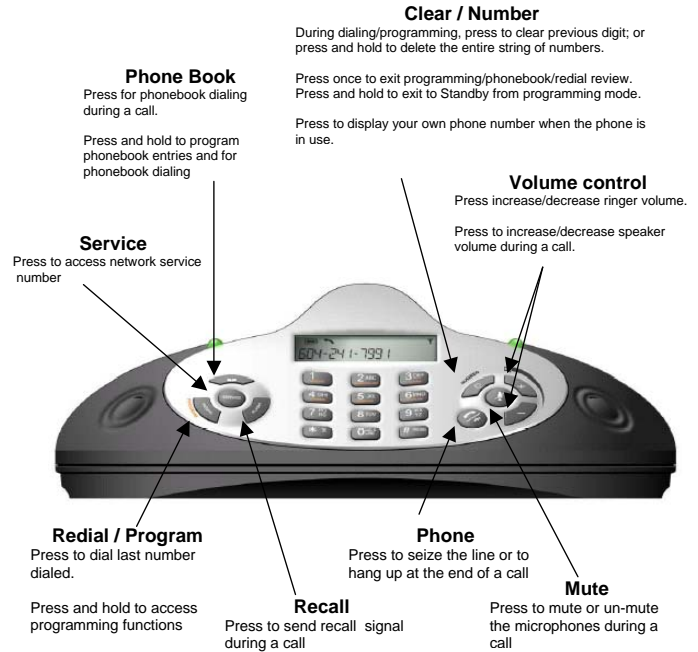

## Base



9

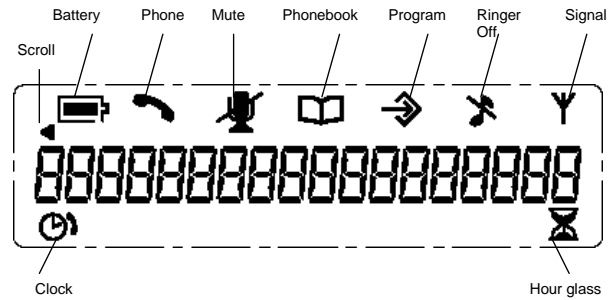

## LCD Display on the POD



Icon	Name	Description
	Battery	<ul style="list-style-type: none"> <li>stays on to indicate battery level</li> <li>flashes when batteries require charging</li> <li>animates during charging</li> </ul>
	Phone	<ul style="list-style-type: none"> <li>flashes according to the cadence during ringing</li> <li>turns on during Phone mode</li> </ul>
	Program	<ul style="list-style-type: none"> <li>turns on during Programming mode</li> <li>turn on during Phonebook Programming mode</li> </ul>
	Mute	<ul style="list-style-type: none"> <li>turns on for muted call during Phone mode</li> </ul>
	Phonebook	<ul style="list-style-type: none"> <li>turns on when in Phonebook</li> </ul>
	Ringer Off	<ul style="list-style-type: none"> <li>turns on when ringer is turned off</li> </ul>
	Signal	<ul style="list-style-type: none"> <li>turns on when radio signal from base detected</li> <li>flashes when portable part is too far from the base or when the base is not powered on.</li> </ul>
	Scroll	<ul style="list-style-type: none"> <li>turns on when the number displayed contains more than 18 digits</li> </ul>
	Clock	<ul style="list-style-type: none"> <li>turns on whenever call elapse timer is displayed</li> </ul>
	Hour glass	<ul style="list-style-type: none"> <li>turns on whenever talk time remaining counter is displayed</li> </ul>



10

## Phone Key

Key Function	Key
Phone Book	
Service	<b>SERVICE</b>
Recall	<b>Recall</b>
Redial / Program	<b>REDIAL</b>
Clear / Number	<b>C</b>
Up	<b>+</b>
Down	<b>-</b>
Phone On/Off	
Mute	
Ringer On/Off Dial Tone	<b>* ✕</b>
Pause	<b># PAUSE</b>

11

## Basic Steps For Installation

1. Set up the base and POD on a flat, stable surface.
2. Connect the output plug of the base adaptor to the  socket on the bottom of the base unit and the adaptor to the main wall outlet. The power LED on the base should become steadily lit.
3. Connect one end of the telephone line to the  socket on the bottom of the base unit and the other end to the wall phone socket.
4. Remove the battery cover on the base of the pod and insert the battery pack (supplied with the unit), observing the correct orientation of the plug with the connector. Relocate the battery compartment door.
5. Connect the output plug of the POD adaptor to the  socket on the top of the POD unit and the power adaptor to power socket. Allow the battery to charge for at least 15 hours before first use.

### CAUTION

Use only the power adaptors supplied with this product. Incorrect adaptor polarity or voltage can seriously damage the unit.

For Base:	For POD:
Input: 240 VAC 50 Hz	Input: 240 VAC 50 Hz
Output: 7 VDC 400 mA	Output: 12 VDC 500 mA
Polarity: Center positive	Polarity: Center positive

### CAUTION

RISK OF EXPLOSION IF BATTERY IS REPLACED BY AN INCORRECT TYPE. Refer to the original type supplied with this telephone. Ni-MH batteries must be disposed of in accordance with applicable waste disposal regulations.

## Charging the POD

If the battery icon flashes or the LED's on the POD flashes RED periodically during phone mode, the battery pack needs recharging. Connect the POD to the AC adaptor plugged to the main wall outlet to start charging.  
Note: POD shall take 30 seconds to power up when the adaptor is connected to a flat battery pack.

## To Ensure Better Performance

1. Locate the conference telephone in a quiet environment.
2. Position the POD within 30 metres of the base unit.
3. Do not use the POD with the other phone in a single room.
4. Do not move the POD during a call.

12

## BASIC OPERATIONS

### Standby

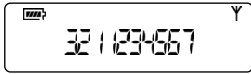

- When the phone is not in use, the POWER LED on the base is turned on and the LCD on the POD displays your phone number, if programmed.

### Answering Calls

When there is an incoming call, the GREEN LEDs on the base and the POD blink and the  icon flashes on the display. The speaker on the POD rings the selected melody.



- Press any key to answer except '+' and '-' keys.



- The call timer and clock icon are displayed. The call timer starts with MM:SS (minute and second).
- The talk time remaining counter and hour glass icon are also displayed. The talk timer starts with HH:MM (hour and minute).

#### Note:

1. The call timer displays the time elapsed on the current active call.
2. The talk time remaining counter displays the **estimated** remaining in use time at the current battery level before the batteries become empty. If for any reason the talk time remaining counter displays 00-00 for a prolonged period of time or is severely inaccurate, charge the POD for a full 15 hours and the counter should reset.
3. When POD is being charged during talk mode, no talk timer will be displayed. "-- --" is shown on the display.

## Making Calls

You can make a call by

- pressing PHONE key and then dialing phone number;
- dialing phone number and then pressing PHONE key;
- redialing the last number you dialed;
- dialing the number in phone book.

### Traditional Dialing

The phone line is seized before the phone number is entered. The phone number cannot be edited or verified before dialing.



- Press **PHONE** key.

(The Phone icon turns on and your phone number turns off.)

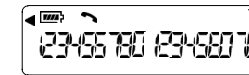

- Dial the number. Digits are displayed.

(Pressing \* and # shall display "F" and "C" respectively.)



- Call timer and talk time remaining counter icons are displayed a while after the last key press.

- To end the call, press **PHONE** key.

Note: If more than 18 digits are dialed, only the last 18 digits shall be displayed. The Scroll icon shall turn on. No limit on the number of digits being dialed out.

## Making Calls

### Predialing

The phone number is entered before the phone line is seized. The phone number can be verified before you place the call.

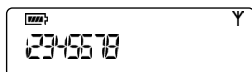

- Enter the phone number. Digits are displayed.
- Press **CLEAR** key to clear previous digit during number entry.

(Pressing \* and # shall display “\*” and “#” respectively. A pause “P” is displayed by pressing and holding “#”.)

- Or, press and hold **CLEAR** key to delete the entire string. Return to Standby.

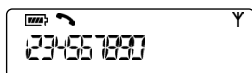

- Press **PHONE** key to dial the number.

-  icon turns on.

- Call timer and talk time remaining counter are on.

- To end the call, press **PHONE** key.

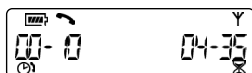

Note: If more than 18 digits are dialed, only the last 18 digits shall be displayed. The Scroll icon shall turn on.  
You can enter up to 44 digits otherwise a reject tone will abort the digit entry.

## Redialing

Redialing allows you to call the last dialed number. You can redial a number by traditional dialing or predialing.

### Traditional Dialing



- Press **PHONE** key to seize the line and wait for dial tone.

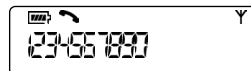

- Press **REDIAL** key (The last number dialed shall be displayed.)

- The last number dialed will be dialed automatically.

- Call timer and talk time remaining counter are displayed accordingly.

- Press **PHONE** key again to end the call.

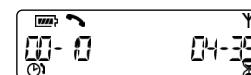

### Predialing

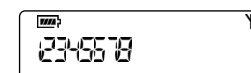

- Press **REDIAL** key. (The last number dialed is displayed. The phone number cannot be edited.)

If you do not want to redial the call,

- Press **CLEAR** key to clear the display and return to Standby.

- Press **PHONE** key to seize the line and the number is dialed out.

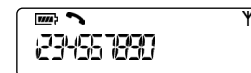



## Redialing



- Call timer and talk time remaining counter are displayed accordingly.
- Press **PHONE** key again to end the call.

Note: If the last dialed number has more than 18 digits, only the last 18 digits shall be displayed. The Scroll icon shall turn on. It can hold up to 44 digits in the last dialed number.

## Phonebook Dialing

Phonebook dialing allows you to call any phone numbers stored in phonebook. Refer to the programming section for how to store or edit the phonebook numbers.

You can use traditional dialing or predialing to call phonebook numbers.

### Traditional Dialing



- Press **PHONE** key to seize the line and wait for dial tone.

- Press **PHONEBOOK** key.

- Press “0” – “9” to display the selected phonebook record.
- The phone number cannot be edited.

(After pressing the phonebook record number, the selected number will be dialed out accordingly.)

- Call timer and talk time remaining counter are displayed accordingly.
- Press **PHONE** key again to end the call.

## Phonebook Dialing

Note: If no phonebook record is selected after **PHONEBOOK** key has been pressed,

- i. Press **CLEAR** key to exit phonebook selection and to return to the call and talk timers.
- ii. Pressing “\*”, “#”, **PHONEBOOK**, and **SERVICE** keys will have no effect.
- iii. Press **MUTE** key to mute the call.
- iv. Press “**UP**” and “**DOWN**” keys to exit phonebook review and to adjust speaker volume.
- v. Press **FLASH** key to exit phonebook review and to send out flash signal.
- vi. Press **REDIAL** key to exit phonebook review and to dial the last dialed number if it is available.
- vii. Exit from the phonebook selection after a while.

## Phonebook Dialing

### Predialing



- Press **PHONEBOOK** key.

- Press “**0**” – “**9**” to select the desired phonebook record.
- The phone number cannot be edited.

Note: If you do not want to make the call, pressing **CLEAR** key to exit phonebook selection and to return to Standby.

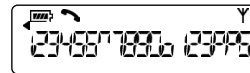

- Press **PHONE** key to seize the line and the number will be dialed out.

- Call timer and talk time remaining counter are displayed accordingly.
- Press **PHONE** key again to end the call.

Note: If the phonebook number has more than 18 digits, only the last 18 digits shall be displayed. The Scroll icon shall turn on. It can hold up to 44 digits in each phonebook number.

## Services Dialing

Services' dialing allows you to call network service (e.g. conference services) by a single key press. Refer to the programming section for how to enter or edit the services phone number.

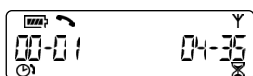
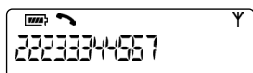
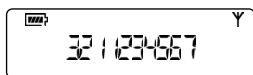

- Press **SERVICE** key in Standby to seize the line.
- The programmed number will be dialed.
- The number will be displayed as it is dialed.
- Call timer and talk time remaining counter are displayed accordingly.
- Press **PHONE** key again to end the call.

Note: If the network services number is not entered or modified and contains no digit, you will hear a reject tone and no call will be dialed.

Note: If the service number has more than 18 digits, only the last 18 digits shall be displayed. The Scroll icon shall turn on.

## Service Centre Quick Access

The Service Centre quick access allows you to call a service centre (e.g. your network provider's service line) by a single key press. Refer to the programming section for how to enter or edit the service centre phone number.

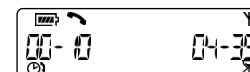
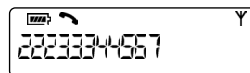
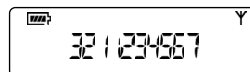

- Press and hold "0" in Standby to seize the line.
- The programmed number will be dialed.
- The number will be displayed as it is dialed.
- Call timer and talk time remaining counter are displayed accordingly.
- Press **PHONE** key again to end the call.

Note: If the service centre number is not entered or is modified and contains no digit, you will hear a reject tone and no call will be dialed.

Note: If the service centre number has more than 18 digits, only the last 18 digits shall be displayed. The Scroll icon shall turn on.

## Things you can do during a call

You can do the following during a call,

- Adjust speaker volume;
- Mute call;
- Change dial tone;
- Send Recall signal;
- Dial extra digits;
- Dial from phonebook record;
- Display user phone number.

### Adjust Speaker Volume

16 different levels of speaker volume can be selected.

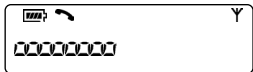

- Press **UP/DOWN** key to adjust the speaker volume during the call.

### Mute Call

All the calls can be muted or unmuted.



- Press **MUTE** key to mute or unmute the call.

(When the call is muted, mute icon turns on and LEDs on POD turn RED and flash slowly).

23

## Things you can do during a call

### Change Dial Tone

Pulse dialing can be changed temporarily to tone dialing during a call. The phone shall return to pulse dialing when the call is ended.



- Press \* and "T" will be displayed after the previously dialed digits.
- Tone dialing is on.

(Digits entered afterwards shall be dialed out by tone dialing.)

### Send Flash Signal

A flash signal can be sent to the network during a call.

- Press **RECALL** key to send recall signal.

### Dialing Extra Digits

More digits can be dialed out during a call.



- Enter extra digits.

(The extra digits shall be displayed to the end of the previously dialed digits and be dialed.)

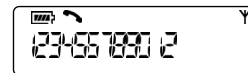

Note: If the total number of digits exceeds 18, only the last 18 digits shall be displayed. The scroll icon shall turn on. The digits shall scroll from right to left as long as digits are entered.

24

## Things you can do during a call

### Dialing from Phonebook Record

You can dial any phonebook number when you are talking on the phone. Phone book dialing can be used as many times as you like during a call.

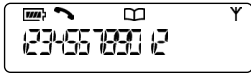

- Press **PHONEBOOK** key.  
(The phonebook icon turns on.)

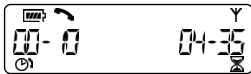

- Press "0" – "9" to dial the phonebook record  
(The phone numbers shall be displayed accordingly and dialed out automatically.)

Note: If no phonebook record has been selected after pressing **PHONEBOOK** key, press **CLEAR** key to exit from the phonebook selection or the phone shall automatically exit from the phonebook selection after a while.

## Things you can do during a call

### Displaying User Phone Number

Your phone number (if it has been programmed) can be displayed during a call.



- Press **CLEAR** key.

(The user phone number shall be displayed if it has been programmed; otherwise, a blank screen shall be displayed.)



- The LCD screen shall return to previous screen after a while; or press **CLEAR** key to clear the phone number and to return to call timer.



## Programming

You can program the ringer melody, dialing mode, Recall duration, user phone number, network service number, and service centre number. You can also reset all settings back to the factory defaults.

### Start Programming

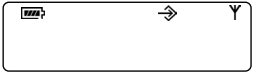

- Press and hold **PROGRAM** key during Standby.  
( icon is on.)
- At any time, press and hold **CLEAR** key to return to Standby.

#### Note:

1. In the programming mode selection, pressing and holding **CLEAR** key will abort all the changes and return to Standby.
2. Invalid entry during programming shall be ignored with a reject tone.
3. If there is an incoming call or paging from the base, programming will be aborted.

**Note:- If you have connected this product to an extension on your PBX, you may need to dial a particular number (e.g. "9" or "0") in order to get dial tone for an outside line. You will need to dial this each time you dial out.**

## Programming

### Ringer Melody



- Press and hold **PROGRAM** key during Standby.
- Press "1" to select ringer melody programming.  
(The current melody number shall be displayed.)
- Press **PROGRAM** key to select melody programming.  
(The current melody number flashes.)
- Press "1" to "5" keys to select melody 1 to melody 5 respectively.  
(The selected melody shall be played once.)
- Press **PROGRAM** key to confirm the selection
- Press **CLEAR** key to exit.

## Programming

### Recall Duration



- Press and hold **PROGRAM** key during Standby.
- Press “3” to select recall duration programming. (The default setting 100ms duration is displayed.)
- Press **PROGRAM** key to select Recall duration programming. (The current selection flashes.)
- Press “1” to “4” to select duration 1 to duration 4 respectively. (The flash durations are displayed in milliseconds and country dependent. The selection flashes.)
- Press **PROGRAM** key to confirm the selection
- Press **CLEAR** key to exit.

31

## Programming

### Users Phone Number

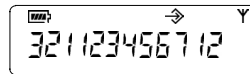
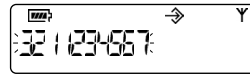

- Press and hold **PROGRAM** key during Standby.
- Press “4” to select user phone number programming. (The current number is displayed if it has been programmed; otherwise a blank screen will be displayed.)
- Press **PROGRAM** key to select phone number programming. (The current number flashes.)
- Press **CLEAR** key to erase the digit of the current number one by one.
- Press and hold **CLEAR** key to erase the entire number and enter new numbers.
- Press **PROGRAM** key to confirm the editing.
- Press **CLEAR** key to exit.

32



## Programming

### Network Services Number

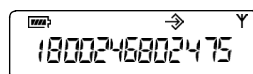
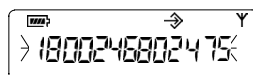
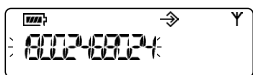
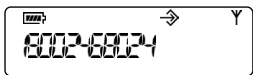

- Press and hold **PROGRAM** key during Standby.
- Press “5” to select network services number programming. (The LCD displays the current number if available; otherwise a blank screen will be displayed.)
- Press **PROGRAM** key to select service number programming. (The current number flashes.)
- Press **CLEAR** key to erase the digit of the current number one by one. Press and hold **CLEAR** key to erase the entire number.
- Enter new numbers.
- Press **PROGRAM** key to confirm the editing.
- Press **CLEAR** key to exit.

33

## Programming

### Service Centre Number

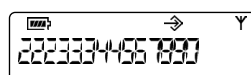
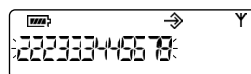
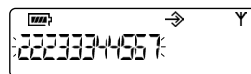
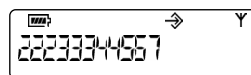

- Press and hold **PROGRAM** key during Standby.
- Press “6” to select service centre number programming. (The LCD displays the current number if it has been programmed; otherwise, a blank screen shall be displayed )
- Press **PROGRAM** key to select service centre number programming. (The current number flashes.)
- Press **CLEAR** key to erase the digit of the current number one by one. Press and hold **CLEAR** key to erase the entire number.
- Enter new numbers.
- Press **PROGRAM** key to confirm the editing.
- Press **CLEAR** key to exit.

34

## Programming

---

### Returning to factory Default Setting

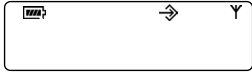

- Press and hold **PROGRAM** key during Standby.
- Press and hold **"9"** to return the phone to the factory default settings.  
(The display will show "8888888888888888".)
- Press **PROGRAM** key to confirm the selection.
- Press **CLEAR** key to exit.
- Refer to the default value section for all factory settings.

35

## Additional Features

---

### Call Recording

- External recording equipment can be connected to the 2.5 mm recording jack on the base unit for call recording.

### Out of Range Warning

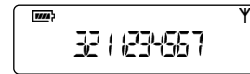
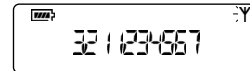

- During phone mode, the LED's on the POD flashes RED quickly and the signal icon flashes when it is too far from the base.
- User should move closer to the base so the call will not be terminated.
- When the POD is moved close enough to the base, the LED's and the signal icon will stop flashing automatically.

### Paging

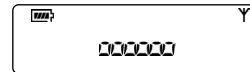

- Press the **PAGE** button at the base during Standby to locate the POD.
- The POD will ring until any key is pressed or stop after 30 seconds if no keys are pressed.

36

## Additional Features

### Low Battery

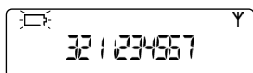

- During standby, the battery icon will become empty and starts flashing when the battery is low.
- During phone mode, the LED's on the POD flashes RED quickly every minute and the empty battery icon flashes when the battery is low.

37

## QUICK REFERENCE GUIDE

Action	Description
To make a call	<ul style="list-style-type: none"> <li>• Press  → Dial tone → Enter number</li> <li>• Enter number → Press  key</li> </ul>
Redialing	<ul style="list-style-type: none"> <li>• Press  → Last number dialed displayed</li> </ul>
Phonebook Dialing	<ul style="list-style-type: none"> <li>• Press  → Press "0" – "9" → Press  → Numbers Dial → Press  to end call</li> </ul>
Network Service	<ul style="list-style-type: none"> <li>• Press <b>SERVICE</b> → the network service number dial</li> </ul>
Service Centre	<ul style="list-style-type: none"> <li>• Press and hold "0" → the service centre number dial</li> </ul>
Storing a number in phonebook	<ul style="list-style-type: none"> <li>• Enter number → Press and hold  → Press "0" – "9" to select the phonebook location → Press </li> </ul>
Adjust speaker volume (during a call)	<ul style="list-style-type: none"> <li>• Press "Up" and "Down" key to adjust the speaker volume.</li> </ul>
Mute Call	<ul style="list-style-type: none"> <li>• Press "Mute" key</li> </ul>
Program Ringer Melody	<ul style="list-style-type: none"> <li>• Press and hold  → Press 1 →  → Press 1 to 5 to select melody → Press </li> </ul>
Program Recall Duration	<ul style="list-style-type: none"> <li>• Press and hold  → Press 3 →  → Press 1 to 4 to select flash duration → Press </li> </ul>
Program User Phone Number	<ul style="list-style-type: none"> <li>• Press and hold  → Press 4 →  → Press <b>C</b> to erase digit or enter new number → Press </li> </ul>

38

## QUICK REFERENCE GUIDE

Program Network Services Number	<ul style="list-style-type: none"> <li>Press and hold <b>Recall</b> → Press 5 → <b>Recall</b> → Press <b>C</b> to erase digit or enter new number → Press <b>Recall</b></li> </ul>
Program Service Centre Number	<ul style="list-style-type: none"> <li>Press and hold <b>Recall</b> → Press 6 → <b>Recall</b> → Press <b>C</b> to erase digit or enter new number → Press <b>Recall</b></li> </ul>
Set Default Setting	<ul style="list-style-type: none"> <li>Press and hold <b>Recall</b> → Press and hold 9 → Press <b>Recall</b></li> </ul>

## TROUBLE SHOOTING

Cannot make a call...

1. Check that the microphone is ON during the call. The GREEN microphone indicators should be lit.
2. Check that the telephone line is connected to the socket on the back of the base unit and to the wall phone socket.
3. Check that the power adaptor is connected to the base.
4. Ensure that POD has a charged battery or has the power adaptor connected and turned on.

Sound quality is poor...

1. Keep noisy equipment (e.g. fans or computer's) away from the base and POD units to avoid excessive noise.
2. Terminate the call and call the other party again to see whether another line provides a better connection.
3. Speak closer to the POD for a better reception.

## TECHNICAL DATA

Audio Bandwidth	200 to 3800 Hz
Speaker Volume	90 dBspl A weighted
Power Supply	230 VAC 50 Hz, 7 VDC 400 mA (for Base) 230 VAC 50 Hz, 12 VDC 500 mA (for POD) Battery pack of 6 AA 1800 mAh (POD only)

## FACTORY DEFAULT VALUES

Items	Factory Default
Speaker Volume on Portable Part	Medium
Ringer Volume	Volume 3
Ringer Melody	Melody 1
Dialing Mode	Tone
Recall Duration	Duration 1 (100ms)
Redial Record	Empty
Phonebook Records	Empty
User Phone Number Record	Empty
Network Service Number Record	Factory Default
Service Centre Number Record	Factory Default

## WALL – MOUNTING

If you wish to wall-mount your base, follow the steps below. Be careful that your base is not too far away from power socket and you do not drill through any electrical wiring or cables.

Step 1: Drill three holes using the template provided in the next page.

Step 2: Insert three screws (not supplied) into the drill holes. Leave approximately 3 mm between the screw head and the wall.

Step 3: Hook your base over the screws. Your base is now ready for use.

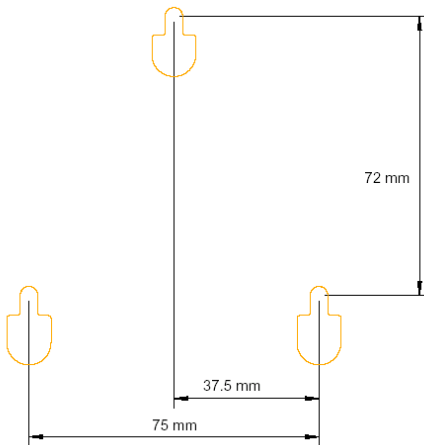

**Note:** Not drawn to scale. For dimensional reference only.

41

## Warranty Information

This product is covered by a 12 month warranty against defective workmanship or parts. The warranty does not extend to damage caused by misuse, negligence, excessive voltage, faults on the telephone line or lightning. This guarantee in no way affects your statutory rights. Full details of the warranty are contained in the enclosed warranty card.

If you feel this product is not working correctly please consult the user guide and ensure that you are using the product in accordance with the instructions.

Remove all extra telephone equipment and connect only this telephone directly to the telephone socket.

If the fault is still present, connect another telephone (if available) to the telephone socket. The results will show you whether the fault lies with this unit or with the telephone line. If the product is working correctly the fault is on the telephone line. Please contact your network administrator for assistance

To orders spare parts and in case of any technical issues you may have with the product please consult our website for further information or send us an email for a prompt response to your enquiry. In the unlikely event of a fault developing, please contact us for assistance. If the product is then found to be faulty you will be asked to return it directly to us with a copy of the purchase receipt.

### Australia

Oricom International Pty Ltd  
PO Box 5681  
South Windsor, NSW 2756

### Customer support

Email: [support@oricom.com.au](mailto:support@oricom.com.au)  
Web: [www.oricom.com.au](http://www.oricom.com.au)  
Fax: (02) 4572 0939  
Ph: 1300 889 785

42

## Free Manuals Download Website

<http://myh66.com>

<http://usermanuals.us>

<http://www.somanuals.com>

<http://www.4manuals.cc>

<http://www.manual-lib.com>

<http://www.404manual.com>

<http://www.luxmanual.com>

<http://aubethermostatmanual.com>

Golf course search by state

<http://golfingnear.com>

Email search by domain

<http://emailbydomain.com>

Auto manuals search

<http://auto.somanuals.com>

TV manuals search

<http://tv.somanuals.com>