

## Information on Safe Operation

---

*Read This Information Before Using Your Oricom Radio.*

### Transmit and Receive Procedure

---

Your two-way radio contains a transmitter and a receiver. To control your exposure and ensure compliance with the general population/uncontrolled environment exposure limits, always adhere to the following procedure:

- Transmit no more than 50% of the time.
- To receive calls, release the PTT button.
- To transmit (talk), press the Push to Talk (PTT) button.

Transmitting 50% of the time, or less, is important because the radio generates measurable RF energy exposure only when transmitting (in terms of measuring standards compliance).

### Exposure to Radio Frequency Energy

---

Your Oricom two-way radio complies with Australian Communications Authority Radiocommunications (Electromagnetic Radiation-Human Exposure) Standard, 2003.

To assure optimal radio performance and make sure human exposure to radio frequency electromagnetic energy is within the guidelines set out in the above standards always adhere to the following procedures.

### Radio Operation and EME Exposure

---

Unauthorized antennas, modifications, or attachments could damage the radio and violate compliance.

Do NOT hold the antenna when the radio is "IN USE." Holding the antenna affects the effective range.

Do not use the radio if the antenna is damaged. If a damaged antenna makes contact with your skin, a minor burn can result.

If you wear a radio on your body when transmitting, always fit the radio on the belt clip (supplied). Always ensure the radio and it's antenna are at least 2.5 cm from your body when transmitting.

## **Radiocommunications (Citizen Band Radio Stations) Class Licence 2002**

No licence is required to own or operate this radio in Australia and New Zealand.

The Radiocommunications (Citizen Band Radio Stations) Class Licence 2002 contains the technical parameters, operating requirements, conditions of licence and relevant standards for Citizen Band (CB) radios. CB radios must comply with the class licence for their use to be authorised under the class licence.

### **Potentially Explosive Atmospheres**

Always turn off your radio prior to entering any area with a potentially explosive atmosphere. Only radio types that are “Intrinsically Safe” should be used in such areas. Do not remove, install or charge batteries in such areas. Sparks in a potentially explosive atmosphere can cause an explosion or fire resulting in bodily injury or even death.

**Note:** The areas with potentially explosive atmospheres referred to above, include fueling areas such as below deck on boats, fuel or chemical transfer or storage facilities, areas where the air contains chemicals or particles (such as grain, dust or

metal powders) and any other area where you would normally be advised to turn off your vehicle engine, such as petrol stations.

Note areas with potentially explosive atmospheres are often-but not always-signposted.

#### **Blasting Caps and Areas**

To avoid possible interference with blasting operations, turn off your radio when you are near electrical blasting caps, in a blasting area, or in areas posted “Turn off two-way radios.” Obey all signs and instructions.

### **Electromagnetic Interference/Compatibility**

Nearly every electronic device is susceptible to electromagnetic interference (EMI). To avoid the possibility of electromagnetic interference and/or compatibility conflicts, turn off your radio in any location where posted notices instruct you to do so such as health care facilities.

#### **Aircraft**

When instructed to do so, turn off your radio when onboard an aircraft. Any use of a radio must be in accordance with applicable regulations per airline crew instructions.

## Medical Devices - Pacemakers

The Advanced Medical Technology Association recommends that a minimum separation of 6 inches (15 cm) be maintained between a handheld wireless radio and a pacemaker. These recommendations are consistent with the independent research by and recommendations of the U.S. Food and Drug Administration.

People with pacemakers should:

- ALWAYS keep the radio more than 15 cm from their pacemaker when the radio is turned ON.
- Not carry the radio in the breast pocket.
- Use the ear opposite the pacemaker to minimize the potential for interference.
- Turn the radio OFF immediately if there is any reason to suspect that interference is taking place.

## Medical Devices - Hearing Aids

Some digital wireless radios may interfere with some hearing aids. In the event of such interference, you may want to consult your hearing aid manufacturer to discuss alternatives.

## Other Medical Devices

If you use any other personal medical device, consult the manufacturer of your device to determine if it is adequately shielded from RF energy. Your physician may be able to assist you in obtaining this information.

## Safety and General Use While Driving

---

Check the laws regarding the use of handheld radios whilst driving, and always obey them.

Do not place a portable radio over an air bag or in the air bag deployment area. Air bags inflate with extreme force. If a radio is placed in the air bag deployment area and the air bag inflates, the radio may be propelled with great force and cause serious injury to persons in the vehicle.

## Your Oricom PMR3000R radio controls



## Your Oricom PMR3000R radio display

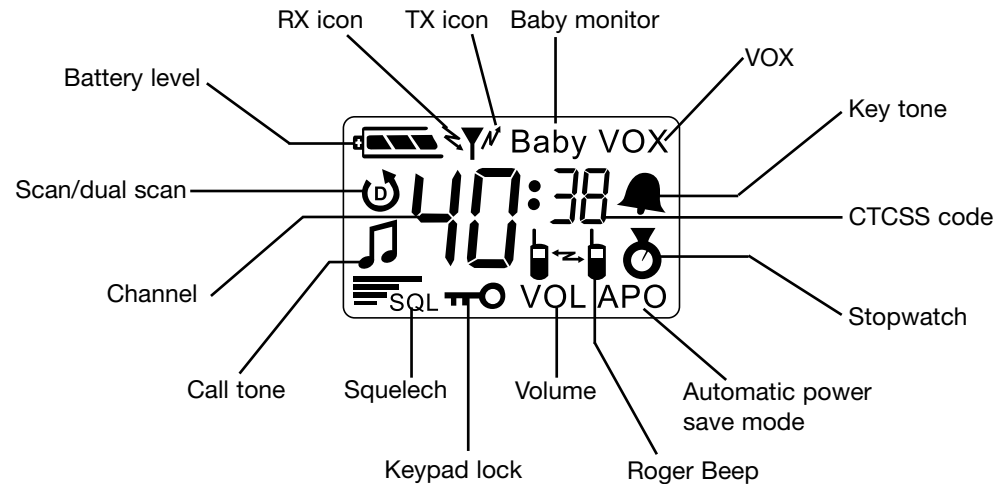

## This pack contains

- 2 UHF radios
- 2 belt clips
- 2 PTT headsets
- 2 Ni-Mh rechargeable battery packs
- 1 twin desk top charger
- 1 AC adaptor

## Installing the batteries

Each radio uses a Ni-Mh rechargeable battery pack (supplied). Or for added convenience you can choose to use 3 AAA alkaline batteries in each radio (not supplied).

### Warnings

- Do not mix old and new batteries.
  - Do not charge alkaline or non rechargeable batteries as they could explode and cause injury.
  - If you are not using the radios for an extended period remove the batteries.
- For replacement Ni-MH battery packs (Order Part No. KEBT-079-1) contact Oricom (02) 4574 8888.

1. Ensure radio is turned off. Remove the belt clip on the back.



2. Locate the clip on the battery cover. Use your fingernail to gently prise open the battery cover and remove.

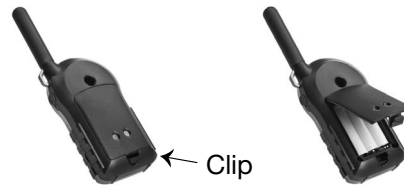



3. Insert the battery pack supplied with charge contacts facing towards you and then replace the battery cover.
4. Plug one end of the AC power adaptor into the charging pod and then the AC adaptor into the power socket.
5. Slide the radios into the charging pod ensuring the charging contacts line up. The red lights on the charge pod glow when radios are properly inserted.
6. The batteries will be fully charged within 14 hours.

## IMPORTANT NOTE

1. When moving between hot/cold environments do not charge the battery until the battery temperature acclimates (usually about 20 minutes).
2. Batteries can cause property damage and/or bodily injury such as burns if a conductive material-like jewellery, keys or chains touch exposed terminals.
3. The conductive material may complete an electrical circuit (short circuit) and become quite hot.
4. Exercise caution in handling any battery, particularly when placing it inside a bag, pocket, purse or any container with metal objects.





## Turning your radio on and off

Press and hold  for three seconds to turn your radio on. The radio chirps and the display will show all feature icons for a brief period. Press and hold  button for three seconds to turn off your radio.

## Adjusting the volume level







When turned on, simply press  or  button to adjust the volume to a comfortable listening level.

## Selecting the channel

1. Press the  button, the currently selected channel number will begin to blink.
2. Press the  or  button to select a channel.
3. Press the  button to set a new channel.

## Roger beep (Talk Confirmation Tone)



This feature transmits a unique tone when you finish transmitting. In the same way as saying “Roger” or “over”, it lets others know you are finished talking.

1. Press  button until  appears. Press  or  to enable or disable Roger beep.
2. When the roger beep is enabled,  will show in the display.
3. When you release the  button you will hear the roger beep.

## Talking and listening





It is good radio etiquette to monitor the channel for activity before you transmit, to ensure that you do not interrupt other users already on the channel.

Press and hold the  button to check for channel activity. If you hear static, the channel is clear for use. Your radio has 40 channels. If you are in a group and you wish to talk to each other, all radios must be set to the same channel and interference eliminator code (CTCSS). If you experience interference and need to change channel, ensure that you change the channel and code of all radios in your group.









1. For maximum clarity, hold radio 5 to 7cm's from mouth.
2. Press and hold  and speak to the microphone. LED indicator light glows continuously when transmitting.
3. To receive messages, release .

## Interference eliminator codes (CTCSS)

The radio has 38 interference eliminator codes (CTCSS) providing you with a choice of channel/code combinations to listen to transmissions using the same CTCSS code on the same channel, effectively blocking out unwanted conversations.

1. Press  until the code number begins to flash.
2. Use  or  to select required CTCSS code 0 (off) or 1-38.
3. Press  to set the new code.



You can specify a different code for each channel.

1. To set a channel and CTCSS code combination, press  and then press  or  to select the channel.
  2. Press  again and then press  or  to select a CTCSS code.
  3. You can not select interference eliminator codes on channel 5 or channel 35. On this channel press . The radio shall skip the codes setting.
  4. Press  to exit the menu and to save the channel and code combination.
- To set another channel and code combination, repeat these steps.



## Channel scan

By scanning, you can monitor channels and codes for transmissions and lock in on the one that interests you. More importantly, you can find someone in your group who has accidentally changed channels and is talking during your scan.



1. To start scanning, briefly press and release the  button.
2. If you activate scan while the CTCSS code is set to 0, then the radio will check for any activity on each channel, regardless of the CTCSS code in use on that channel.
3. If you activate scan while the CTCSS code is set at 1 to 38, then the radio will check for any activity on each channel, except the CTCSS code 0 in use on that channel.

4. While the radio is scanning, the scan icon will display and the radio will scroll through the channels.
5. When activity is detected on a channel, the radio will stop scanning and you will hear whatever transmissions are detected. The radio's display will show the channel and CTCSS code on which activity was detected.
6. If you want to respond to the transmission, press  within 5 seconds and you can respond.
7. The radio will resume scanning after 5 seconds of inactivity on the channel.
8. To stop scanning, briefly press and release .

### Scan advance



If scan stops on a channel that you don't want to listen to, briefly press  or  to resume scanning for the next active channel.

### Nuisance delete

If scan continuously stops on an undesired channel, press and hold  or  for at least 3 seconds, then release. This will temporarily remove the undesired channel from the scan list.

To restore the channel to the scan list, turn the radio off and then on. You cannot remove your home channel from the scan list (your home channel is the channel your radio was set to when you activated scan).

### Keypad lock





Press and hold the  button for three seconds to lock or unlock the keypad. When the radio is locked, the  icon will show in the display.

The keypad lock disables the ,  and  buttons. It also disables the scan function, but allows you to use the  button to monitor the channel.

### Call tone

A call tone alerts others in your group that you want to talk. Your radio has 10 call tones to choose from. Set the call tone to 0 to disable the function.

### Selecting a call tone

1. With the radio on, press  repeatedly, until  appears in the display.
2. The current call tone setting will begin to flash.
3. Press  or  to change and hear call tones while the setting number is flashing.
4. Press  to set the new call tone.

### Note:

1. The Australian UHF CB Radio Standard restricts tone calling to 3 seconds. This unit will only transmit for a maximum 3 seconds in any 60 seconds.
2. The radio does not support the call tone feature on channels 5 or 35.



### Channel busy indicator

The red LED will flash twice per second to indicate that the channel is in use.

### Time-out timer

The time-out timer feature helps extend battery life by preventing accidental transmission. The radio will emit a continuous warning tone if the  button is pressed for more than 60 continuous seconds and will stop transmitting.



### The battery level meter

The battery level meter located in the display indicates how much battery power you have remaining to protect the rechargeable battery. When the battery meter has one segment left, the radio will chirp after releasing  or every 10 minutes.

### Duplex mode

Repeater stations can re-transmit your signal over a wider area giving you extended range depending on the location, height and availability of the local repeater station. For information on the locations of repeater sites in Australia and New Zealand visit our website.

Your radio supports duplex mode on channels 1 - 8. If the repeater channel in your area is channel 1, when you are in duplex mode the transmit channel will be channel 31.

1. Select the repeater channel in your area (channel 1 to channel 8).
2. Press the  button to enter duplex mode, press  or  to switch between duplex and simplex mode.









For example,

Select channel 1, duplex mode will display:  1. Simplex mode will display 1.

### Dual channel scan

In stand-by, the PMR is set on one set channel with CTCSS code. The PMR will only receive signals transmitted on that channel and CTCSS code. Dual Channel Monitor allows you to monitor a second channel with CTCSS code.

To set dual channel and code

1. Press  until  display.
2. Pressing the  or  button will increase or decrease the dual channel.
3. Press  again and then press  or  button to increase or decrease the dual code number.
4. Press  to exit the menu and save the dual channel and code combination.

When the Dual Channel Monitor function is activated, the PMR will switch sequentially between the standby channel + CTCSS and the Dual Channel + CTCSS. When there is activity on the Dual Channel + CTCSS, the active channel will be displayed for 5 seconds. Within this period, you have the possibility to answer the transmission.

### To disable the dual channel scan

Repeat the setup 1 and 2, and then roll-over at 'DF' which means the dual scan is disabled.

### Hands-free use (VOX)

This feature allows you to transmit “hands-free” by talking while using the VOX headsets connected to the radio.

Note: When using the headsets with your radio, turn your radio off before you place the accessory on your head or in your ear.





#### How to use VOX

1. Turn off your radio.
2. Insert the VOX headset into the headset socket.
3. Turn on your radio; the VOX icon will appear in the display.
4. To transmit, speak into the headset microphone. To receive, stop talking.
5. Pressing  button or removing VOX headset will disable VOX function.

### Hands-free use (Ivox)

This feature allows you to transmit “hands-free” by talking into the radio microphone without using the headset.





#### How to use the IVOX feature

1. Press  button until VOX appears.
2. Press  or  button to “DF” to disable the IVOX or enable IVOX by select level 1, 2 or 3.
3. Press  button to confirm your setting.
4. At standby mode, when IVOX function activated, to transmit, speak into the radio microphone. To receive, stop talking.
5. Press  will disable IVOX operation.

Note: There is a short delay after you start talking, before the radio transmits.

### Setting VOX and IVOX sensitivity levels

Adjusting your radio’s VOX and IVOX microphone sensitivity level helps to minimize the possibility of unintended noises triggering a transmission, and enhances the ability to pick up quiet voices. If a headset is fitted to your radio these instructions will help you to adjust the VOX sensitivity.

1. Press  until VOX and a flashing number appears in the centre of the display. With the headset connected you will see  in the top right corner of the display. Without the headset you will see I.
2. Select sensitivity level 1, 2 or 3 by using  or . Choose -
  - 1- If you speak loudly, or are in a noisy environment.
  - 2- Suitable for most applications.
  - 3- If you speak softly, or are in a quiet environment.

Note: When you connect a VOX headset, the radio will automatically be set to the last chosen VOX sensitivity level. If IVOX is active, the radio will automatically select IVOX level.

## Monitor function

This feature allows you to listen for weak signals on the current channel.

1. Pressing and holding  allows you to monitor your channel for activity.

Note: It is good radio etiquette to monitor the channel for activity before you transmit, to ensure that you do not interrupt other users already on the channel.





## Baby monitor function

One of the units can be set as Baby monitor. The radio will transmit a signal when it is activated by the crying baby or another sound in the room.

The PMR will no longer be able to receive signals to avoid that your baby is disturbed during his/her sleep.

The other PMR must be set to the same channel and CTCSS code to receive the signal from the Baby Monitor.





### To set your radio as baby monitor

1. Press  button until Baby appears.
2. Press  or  button to set baby monitor sensitivity level to 1/2/3 to turn baby monitor function ON.
3. Press  to confirm the setting.

Note:





1. In standby mode, when speaking into the microphone, the radio will automatically transmit like IVOX does.
2. The radio can't receive or if you press any key it will not generate key tones so that you will not disturb the baby.

### To disable baby monitor function

1. Press  button until Baby appears.
2. Press  or  until OF appears.
3. Press  to confirm the setting.

### Setting squelch level





The adjustable Squelch allows you to optimize the radios sensitivity. It also allows you to increase the sensitivity and receive weaker signals. There are 4 decreasing levels of sensitivity.

1. Press  button until SQL appears.
2. Press  or  button to adjust the squelch levels.
3. Press  to confirm.

Note: Level 1 (SQL and one bar icon display) is the most sensitive level, which means the radio can receive very weak signal. While at level 4, the radio can only receive at strong signal.







### Automatic energy saving mode

The radios are designed with a power saving mode. If no transmissions take place within a certain time, the unit switches itself off automatically.

1. Repeatedly press the  button until APO appears in the display and the current setting will flash.
2. Select the required setting of 1, 2...12 hours using the  and  buttons. Energy saving mode is switched off with the setting .
3. Confirm the selection with the .







### Keypad tone

Once you enable this function, the unit will beep briefly, When a button is pressed.

1. Press  button until  appears, The current setting  flashes.
2. Press  or  button to turn on or off.
3. Press  to confirm.

## Stopwatch

The PMR3000R has a stopwatch function (mm:ss).

1. Press  button until  appears.
2. Press  button to start the stopwatch.
3. When the stopwatch is running, press  button to stop counting and display the lap time, the counter will continue in the background. Press  to proceed counting.
4. When the counter is stops, press  button to reset the counter.

## UHF channels and frequencies

**IMPORTANT NOTE:** The operation of your PMR3000R radio in Australia and New Zealand is subject to conditions in the following licenses:

In Australia the ACMA Radio communications (Citizen Band Radio Stations) and in New Zealand the General User Radio License for Citizen Band Radio.

UHF Repeater operation is used when long distance communication is required, unless specifically needed use of the repeater channels is to be avoided. Note Channels 5 and 35 are emergency channels. Channel 11 is a calling channel for establishing communication and Channel 40 is the customary road vehicle channel. Channels 22 and 23 are for Telemetry and Telecommand use, voice communications are not allowed on these channels by law.

Channel	Frequency (MHz)	Usage	Channel	Frequency (MHz)	Usage
1	476.425	Duplex RX/Simplex	21	476.925	Simplex
2	476.450	Duplex RX/Simplex	22	476.950	No Use
3	476.475	Duplex RX/Simplex	23	476.975	No Use
4	476.500	Duplex RX/Simplex	24	477.000	Simplex
5	476.525	Emergency	25	477.025	Simplex
6	476.550	Duplex RX/Simplex	26	477.050	Simplex
7	476.575	Duplex RX/Simplex	27	477.075	Simplex
8	476.600	Duplex RX/Simplex	28	477.100	Simplex
9	476.625	Simplex	29	477.125	Simplex
10	476.650	Simplex	30	477.150	Simplex
11	476.675	Simplex (Calling Channel)	31	477.175	Duplex TX/Simplex
12	476.700	Simplex	32	477.200	Duplex TX/Simplex
13	476.725	Simplex	33	477.225	Duplex TX/Simplex
14	476.750	Simplex	34	477.250	Duplex TX/Simplex
15	476.775	Simplex	35	477.275	Emergency
16	476.800	Simplex	36	477.300	Duplex TX/Simplex
17	476.825	Simplex	37	477.325	Duplex TX/Simplex
18	476.850	Simplex	38	477.350	Duplex TX/Simplex
19	476.875	Simplex	39	477.375	Simplex
20	476.900	Simplex	40	477.400	Simplex

## Attaching the belt clips

### Attaching the belt clips (2 included)

Each radio is supplied with a belt clip.

To attach, align belt clip post with hole in the back of the radio and gently push until it clicks into place.



### Removing the belt clip

To remove, push release tab on top of belt clip down to release catch and pull belt clip from the back of the radio.

## Warranty information (Australia)

(a) **Warranty.** Oricom International Pty Ltd (Oricom) warrants that the product is free from defects in materials and workmanship for a period of 12 months effective from the date of purchase. This warranty in no way affects your statutory warranty under the Trade Practices Act 1974 or any other similar legislation. It is important that you read the Warranty Card as it contains full and additional details of the warranty, limitation of warranty and conditions for receiving the warranty services during the warranty period. The Warranty Card is located in the package.

(b) **Exclusion and limitation of liability.** Oricom will not be in breach of a warranty or condition expressly stated in this User Guide or the Warranty Card or implied by the Trade Practices Act and excludes any liability arising under any statutory or common law for damages or any other remedy if the damage occurs as a result of:

- (i) Failure by you to follow the instructions in the User Guide for the installation and proper functioning of the product;
- (ii) Negligence on your part or misuse by you of the product;
- (iii) Any un-controlled external cause to the phone not functioning including but not limited to electricity failure, lighting, over voltage;

- (iv) Non adherence by you to the warnings in the User Guide and the User Guide generally; and
- (v) Modification to the product or services carried out to the product by anyone other than Oricom or on Oricom's behalf.

Oricom will not be liable for consequential losses including loss of profits arising from a cause of action in contract, tort or any other statutory or common law (except where a statute or any law prohibits this exclusion). The warranty does not extend to damage caused by misuse, negligence, excessive voltage, faults on the telephone line or lightning. This warranty in no way affects your statutory rights. Full details of the warranty are contained in the enclosed warranty card.

## **Customer support**

---

If you feel this product is not working correctly please consult the user guide and ensure that you are using the product in accordance with the instructions.

To order spare parts additional radio, replacement batteries and in case of any technical issues you may have with the product please consult our website for further information or send us an email for a prompt response to your enquiry.

In the unlikely event of a fault developing, please contact us for assistance. If the product is then found to be faulty you will be asked to return it directly to us with a copy of the purchase receipt.

## **Contact us**

---

### **Australia**

Oricom International Pty Ltd  
Locked Bag 658  
South Windsor NSW 2756  
Australia

### **Customer support**

Email: [support@oricom.com.au](mailto:support@oricom.com.au)  
Web: [www.oricom.com.au](http://www.oricom.com.au)  
Fax: (02) 4574 8898  
Phone: 1300 889 785

## Free Manuals Download Website

<http://myh66.com>

<http://usermanuals.us>

<http://www.somanuals.com>

<http://www.4manuals.cc>

<http://www.manual-lib.com>

<http://www.404manual.com>

<http://www.luxmanual.com>

<http://aubethermostatmanual.com>

Golf course search by state

<http://golfingnear.com>

Email search by domain

<http://emailbydomain.com>

Auto manuals search

<http://auto.somanuals.com>

TV manuals search

<http://tv.somanuals.com>