

XTREME 300, 400, 800 & 1200 OWNER'S MANUAL



 **ORION**™
HIGH PERFORMANCE CAR AUDIO

TABLE OF CONTENTS

INTRODUCTION	3
WARRANTY	6
SPECIFICATIONS	8
TECHNICAL DESIGN FEATURES	10
SYSTEM PLANNING	12
POWER CONNECTIONS	20
SPEAKER CONNECTIONS	24
INPUT SECTION	32
INTERNAL CROSSOVER SECTION	34
INTELLI Q	38
AUXILIARY OUTPUT SECTION	42
REMOTE GAIN SECTION	43
INSTALLATION TIPS	44
TROUBLESHOOTING TIPS	50
AUTOSOUND 2000 TROUBLESHOOTING TIPS	52

INTRODUCTION

Thank you for your purchase of ORION's XTREME power amplifier. Each XTREME amplifier is designed to be the leader in its class offering the most power, advanced features and extreme ease of use. In high-end sound systems or high SPL systems, the XTREME amplifiers will give you years of trouble-free performance.

- XTREME 300- 75 watt per channel 2 channel amplifier with built-in fully variable high-pass, low-pass or bandpass crossover with INTELLLI Q. Equipped with remote gain capability, the XTREME 300 is capable of 3, 2, or 1 channel operation with a maximum power capability of 300 watts into 4Ω mono.
- XTREME 400- 100 watt per channel 2 channel amplifier with built-in fully variable high-pass, low-pass or bandpass crossover with INTELLLI Q. Equipped with remote gain capability, the XTREME 400 is capable of 3, 2, or 1 channel operation with a maximum power capability of 400 watts into 4Ω mono.
- XTREME 800- 200 watt per channel 2 channel amplifier with built-in fully variable high-pass, low-pass or bandpass crossover with INTELLLI Q. Equipped with remote gain capability, the XTREME 800 is capable of 3, 2, or 1 channel operation with a maximum power capability of 800 watts into 4Ω mono
- XTREME 1200- 300 watt per channel 2 channel amplifier with built-in fully variable high-pass, low-pass or bandpass crossover with INTELLLI Q. Equipped with remote gain capability, the XTREME 1200 is capable of 3, 2, or 1 channel operation with a maximum power capability of 1200 watts into 4Ω mono

The installation of all ORION components will determine the overall performance result. Improper installation will not only limit the performance of your ORION system but also potentially compromise the reliability of this amplifier. To ensure proper sonic results and component reliability, please refer to your Authorized ORION dealer for installation assistance of advice. If you decide to perform the installation yourself, read the entire installation section of this manual before beginning the installation.

ABOUT THIS MANUAL

This manual is designed to answer your questions about this product. In the event you have questions not covered in this manual, please refer questions to your local Authorized ORION Dealer. Additionally, you can call ORION's Technical Support Hotline at 1-800 315-2052 or (480) 705-5600 for assistance.

PRACTICE SAFE SOUND

Continuous exposure to sound pressure levels over 100 dB may cause permanent hearing loss. High powered automotive sound systems can generate sound pressure levels in excess of 130 dB. When playing your system at high levels, please use hearing protection and prevent long term exposure.

RECORD YOUR SERIAL NUMBER AND DATE:

MODEL: _____

SERIAL NUMBER: _____

DATE OF PURCHASE: _____

COMPANY PURCHASED FROM: _____

WHAT'S IN THE BOX

QTY	DESCRIPTION
1	XTREME power amplifier
2	2 conductor 4 gauge power connector
1	5 conductor 12 gauge speaker connector
4	#8 Phillips Pan Head Screws
1	XTREME Reference Manual



WARRANTY

ORION Industries Inc. warrants this product to be free from defects in material and workmanship under the following terms:

Parts and Labor are warranted for a period of 3 years IF:

- a. The product is purchased from an Authorized ORION Dealer
- b. The product is installed by an Authorized ORION Dealer

Parts and Labor are warranted for a period of 1 year IF:

- a. The product is purchased from an Authorized ORION Dealer
- b. The product is NOT installed by an Authorized ORION Dealer

Parts and Labor are warranted for a period of 90 days IF:

- a. The product is NOT purchased from an Authorized ORION Dealer

If you are uncertain as to whether your dealer is authorized, please contact ORION at 1-800-350-9726 or (480) 705-5600. In countries other than the USA, each distributor warrants the ORION product it sells.

The Following conditions and situations are NOT covered by this warranty:

Any product on which the serial number has been defaced, modified or removed

Damage or malfunction resulting from:

- a. Accident, misuse, abuse, unauthorized modification or failure to follow the instructions provided with this product.
- b. Repair by anyone NOT authorized by ORION.
- c. Damage due to shipping (these claims must be presented to the freight carrier)
- d. Removal or installation of this product.
- e. Any failure that has NOT been caused by a defect in material or workmanship.

This warranty is in effect for the original purchaser only. ORION will pay for labor and material expense for covered items. ORION does not cover removal or installation charges, payment of shipping charges to ORION, payment of OUT-OF-WARRANTY shipping charges, or damage to other property caused by any defects in this product.

For all warranty and non-warranty service issues, please refer to your nearest Authorized ORION Dealer for assistance. If you require additional information or assistance regarding service repair issues, please call 1-800-350-9726 or (480) 705-5600.

Exclusion

1. This warranty is in lieu of all other warranties expressed or implied
2. In no event will ORION be liable for any consequential damages resulting from the use of this product or any defect of this product.

This Warranty gives you specific legal rights and you may also have other rights which vary from state to state.

SPECIFICATIONS

AMPLIFIER SECTION	XTREME 300	XTREME 400	XTREME 800	XTREME 1200
Power output 4 Ω Stereo (watts)	75 watts	100 watts	200 watts	300 watts
Power output 2 Ω Stereo (watts) ¹	150 watts	200 watts	400 watts	600 watts
Power output 4 Ω Mono (watts) ¹	300 watts	400 watts	800 watts	1200 watts
Distortion all channels driven (from 20Hz to 20kHz)	<0.1% THD	<0.1% THD	<0.1% THD	<0.1% THD
Frequency Response	20Hz to 20 kHz \pm 0.25 dB	20Hz to 20 kHz \pm 0.25 dB	20Hz to 20 kHz \pm 0.25 dB	20Hz to 20 kHz \pm 0.25 dB
Linear Bandwidth	6Hz to 50 kHz \pm 3dB	6Hz to 50 kHz \pm 3dB	6Hz to 50 kHz \pm 3dB	6Hz to 50 kHz \pm 3dB
Signal-to-noise ratio full bandwidth @ rated output power	> 100 dB	> 100 dB	> 100 dB	> 100 dB
Damping factor @ output connector full bandwidth	>400 at output connector	>400 at output connector	>400 at output connector	>400 at output connector
Slew Rate	> 30V/ μ s	> 30V/ μ s	> 30V/ μ s	> 30V/ μ s
input sensitivity ³	200 mV to 5 Vrms	200 mV to 5 Vrms	200 mV to 5 Vrms	200 mV to 5 Vrms

input impedance	47k Ω	47k Ω	47k Ω	47k Ω
fuse type	(2) 15 AMP ATC	(2) 20 AMP ATC	(2) 30 AMP ATC	(6) 30 AMP ATC
CROSSOVER SECTION				
low-pass crossover ⁴	Continuously variable	Continuously variable	Continuously variable	Continuously variable
low-pass frequency range	45Hz to 5kHz	45Hz to 5kHz	45Hz to 5kHz	45Hz to 5kHz
high-pass crossover	Continuously variable	Continuously variable	Continuously variable	Continuously variable
high-pass frequency range	10Hz to 1kHz, 100Hz to 10kHz	10Hz to 1kHz, 100Hz to 10kHz	10Hz to 1kHz, 100Hz to 10kHz	10Hz to 1kHz, 100Hz to 10kHz
INTELLi Q boost range	0dB to 10dB	0dB to 10dB	0dB to 10dB	0dB to 10dB
GENERAL	11" x 10.25" x 2.25" 279mm x 260mm x 57mm (L x W x H)	12" x 10.25" x 2.25" 305mm x 260mm x 57mm (L x W x H)	18" x 10.25" x 2.25" 457mm x 260mm x 57mm (L x W x H)	25" x 10.25" x 2.25" 635mm x 260mm x 57mm (L x W x H)(L x W x H)

1. All channels driven, continuous 4 Ω load, 20 Hz to 20,000 Hz, <0.1% THD, power input voltage at 12.0 VDC.
2. All channels driven, continuous 2 Ω load, 20 Hz to 20,000 Hz, <0.1% THD, power input voltage at 12.0 VDC.

TECHNICAL DESIGN FEATURES

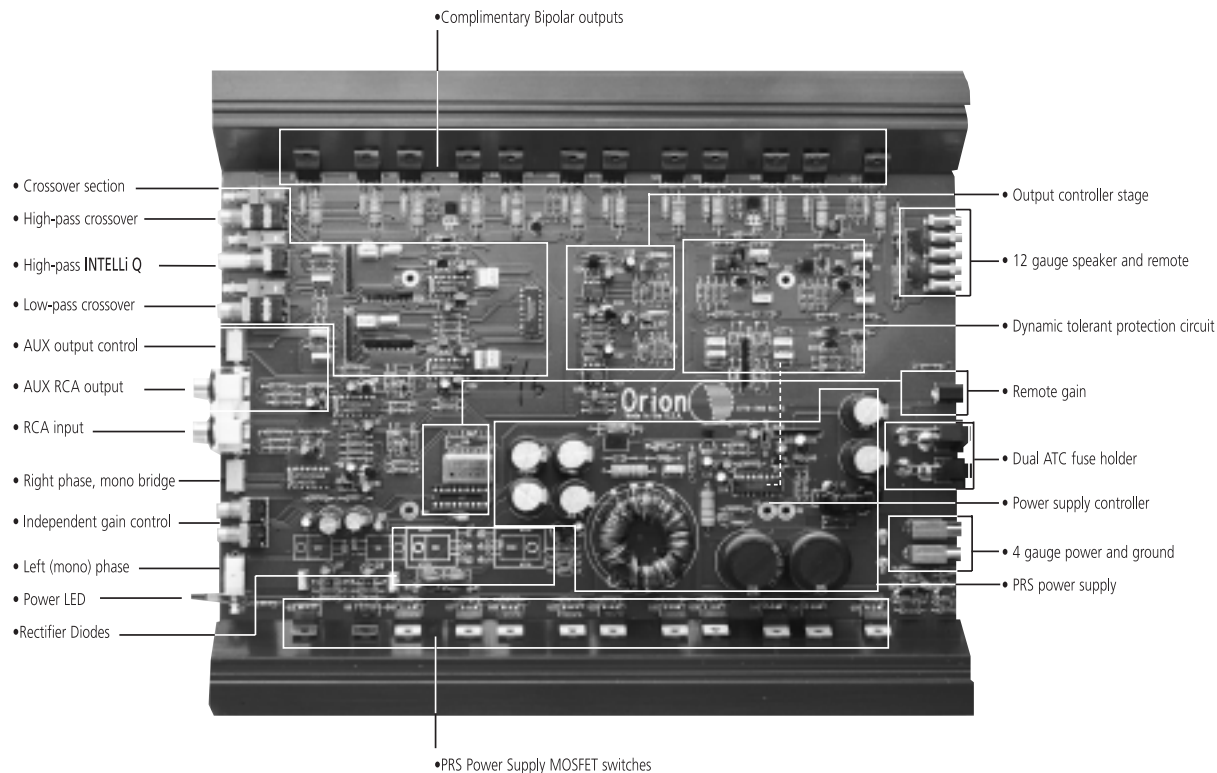

AMPLIFIER CALL OUTS

1. Power LED-when lit indicates that the amplifier is on.
2. Output Configuration Switches-determine the output configuration of the amplifier
3. Independent Gain Controls-continuously adjust from 200mV to 5Vrms for full power output
4. RCA inputs-accepts RCA input from a source unit, preamplifier or equalizer
5. AUX RCA outputs-provides easy connection to additional amplifiers.
6. AUX RCA output control-determines the audio signal out the AUX RCAs
7. Low-pass Frequency Control-adjusts the frequency of the low-pass crossover
8. Low-pass Crossover activation switch-activates the low-pass crossover
9. INTELLI Q adjust control-adjusts the "Q" boost of the high-pass crossover
10. High-pass "x10" Frequency range switch- selects the frequency range of the high-pass crossover
11. High-pass frequency control- adjusts the frequency of the high-pass crossover
12. High-pass Crossover activation switch- activates the high-pass crossover

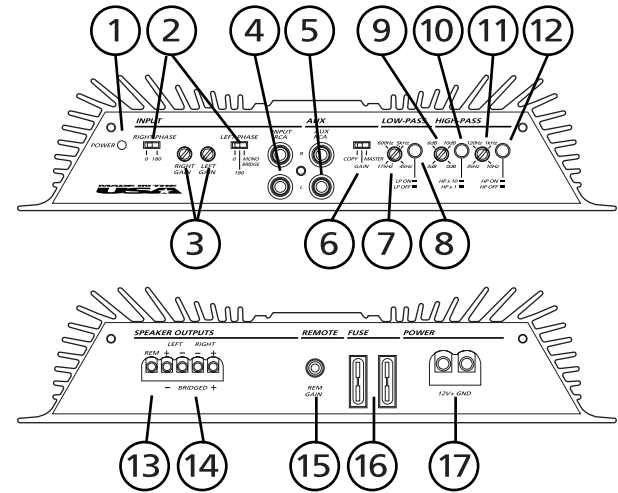

13. REM Remote turn-on input-turns on the amplifier when fed 12 V+
14. Speaker Connections-allows up to 12 gauge speaker wire.
15. Remote Gain Control Port-allows dashboard remote gain control.
16. Fuses-Protects the amplifier from over current situations.
17. Power Connections-allows up to 4 gauge power and ground cables.

SYSTEM PLANNING

The easiest way to maximize the performance for your ORION XTREME amplifier is to properly plan your system. By planning your system, you can avoid situations where the performance or the reliability of your system is compromised. Your Authorized ORION dealer has been trained by ORION Industries on how to maximize your system's sonic potential. Authorized ORION dealers are a valuable resource in helping you with your system design and installation. If you wish to venture on with your own system design, here are some systems designed by ORION Industries.

SYSTEM 1 is a simple two channel amplifier driving a pair of satellites

- Lowest Recommended Impedance is 2Ω Stereo.
- RCA inputs are connected to both left and right channels
- Left Phase switch set to 0°
- Right Phase switch set to 0°
- Gain controls can be set together or independently of each other
- Output is configured for high-pass operation.
- Output is configured for stereo operation.

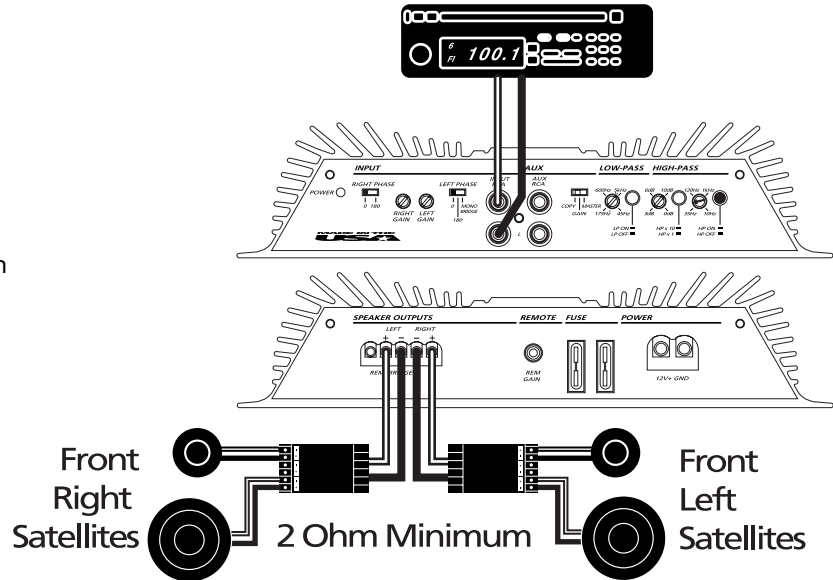

TUNING NOTE: The phase switches can be individually switched for improved sound quality. Try different phase switch positions for best sonic results.

SYSTEM 2 adds an additional amplifier to drive the subwoofers. A RGC-1 (Remote Gain Control) has been added to the subwoofer amplifier for dash mounted subwoofer level control.

AMPLIFIER 1

- Output is configured for high-pass operation.
- Left Phase switch set to 0°
- Right Phase switch set to 0°
- Gain controls can be set together or independently of each other

AMPLIFIER 2

- Output is configured for band-pass operation.
- The high-pass crossover is used as a subsonic filter with INTELLI Q.
- RCA inputs are connected to both left and right channels
- Left Phase switch set to 0°
- Right Phase switch set to 180°
- Gain controls must be set identically for both left and right channels.

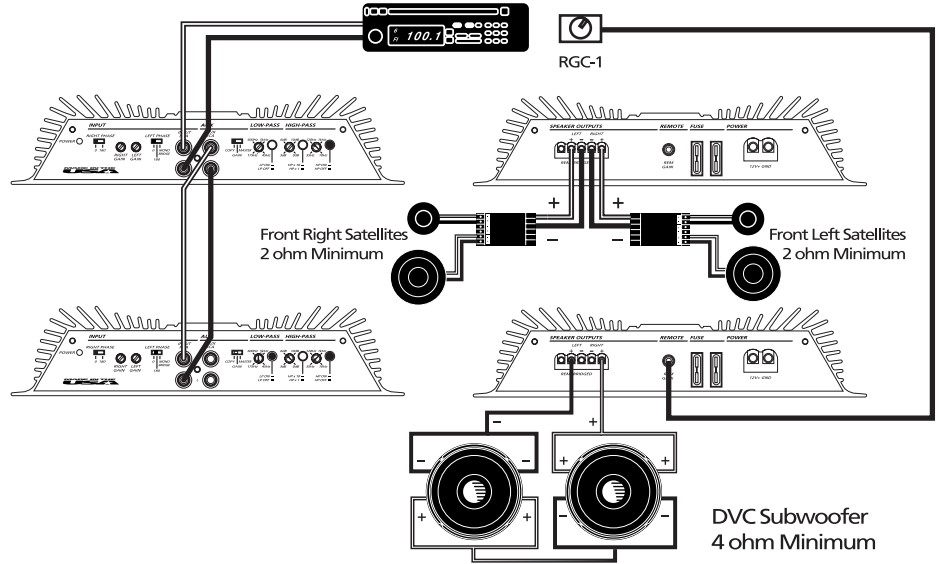

TUNING NOTES:

Amplifier 1: The phase switches can be individually switched for improved sound quality. Try different phase switch positions for best sonic results.

Amplifier 2: The phase switches can be individually switched for improved sound quality. In the summed bridged configuration the left and the right phase must be set opposite from each other in order to operate correctly. The high-pass crossover is used as a subsonic filter with INTELLI Q. Configure the high-pass crossover for "LOW" frequency range operation and set according to instructions explained in the High-pass Crossover Section in this manual.

SYSTEM 3

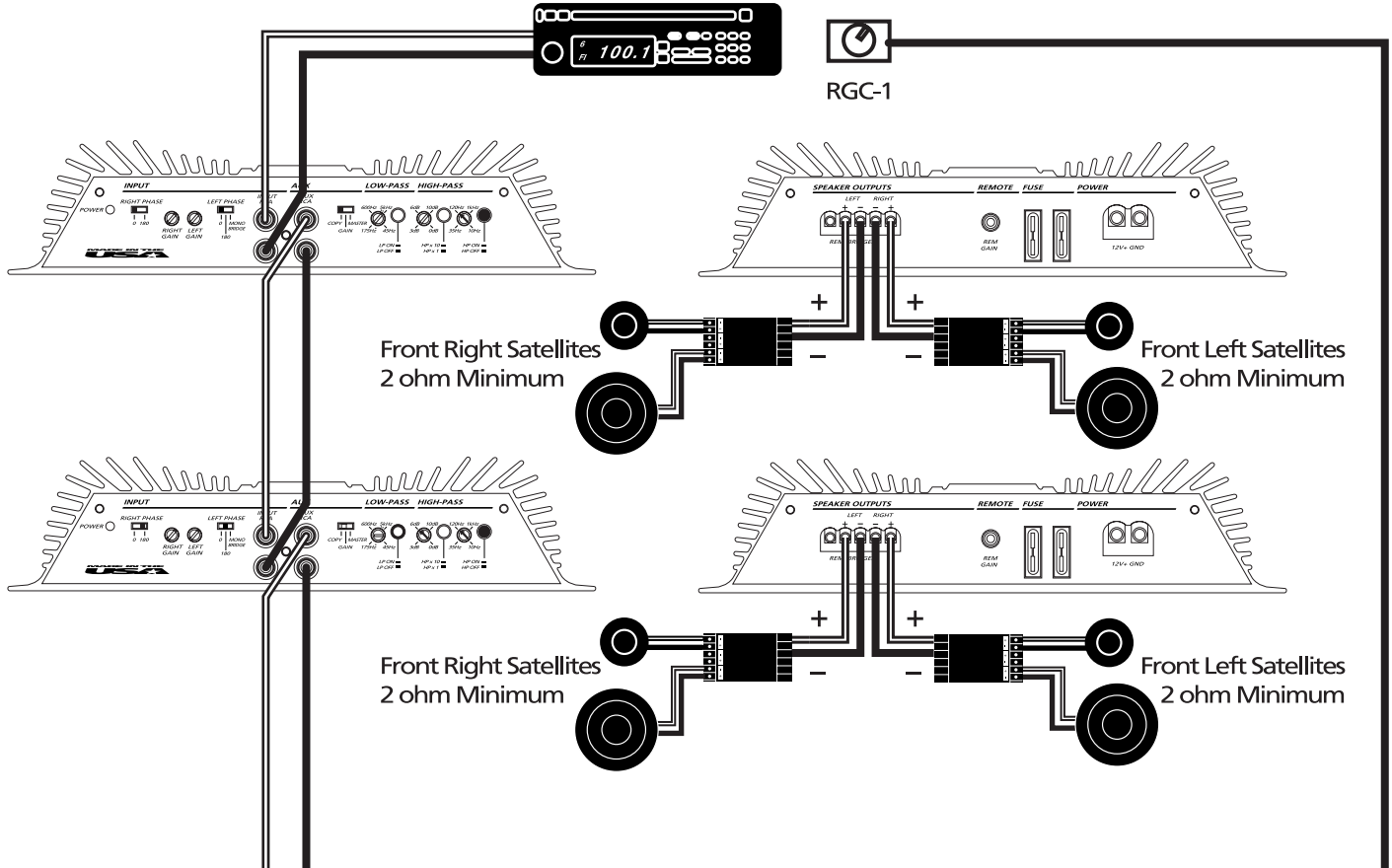

SYSTEM 4

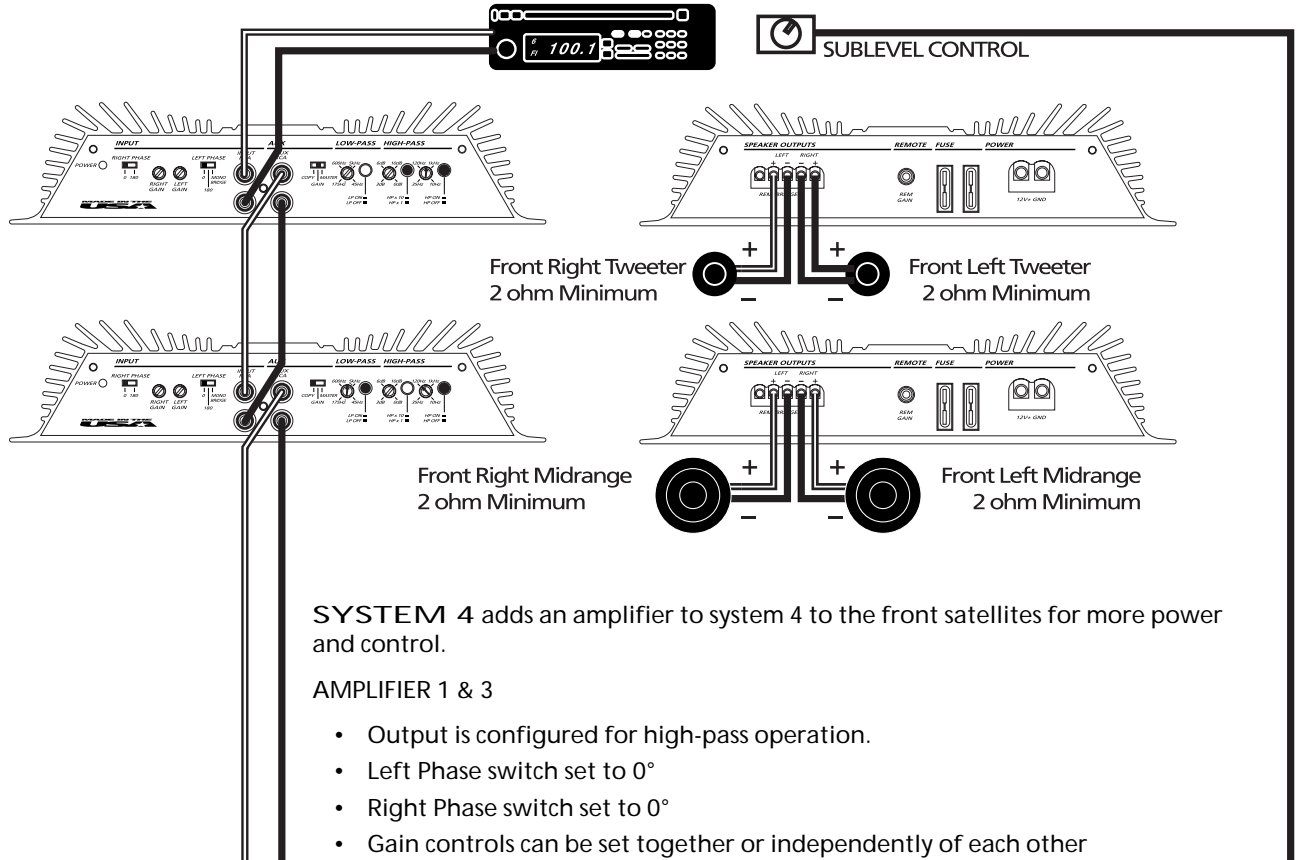

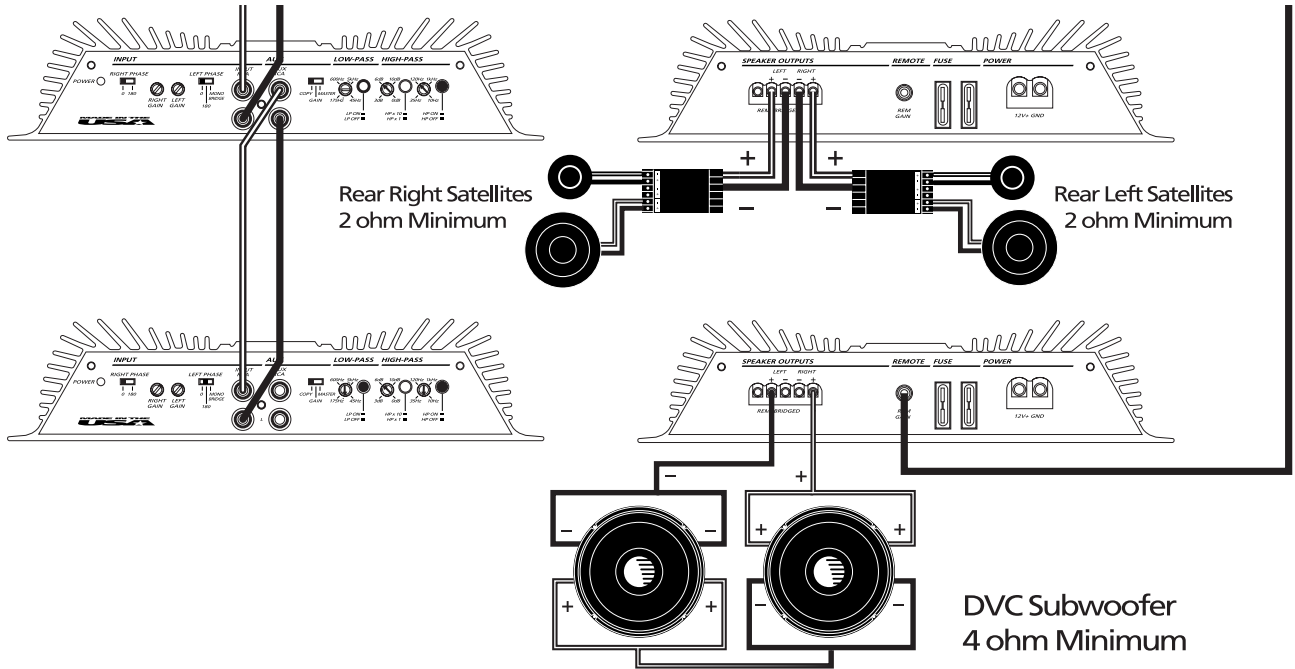

AMPLIFIER 2

- Output is configured for bandpass operation.
- Left Phase switch set to 0°
- Right Phase switch set to 0°
- Gain controls can be set together or independently of each other

AMPLIFIER 4

- Output is configured for band-pass operation.
- The high-pass crossover is used as a subsonic filter with INTELLI Q.
- RCA inputs are connected to both left and right channels
- Left Phase switch set to 0°
- Right Phase switch set to 180°
- Gain controls must be set identically for both left and right channels

SYSTEM 5

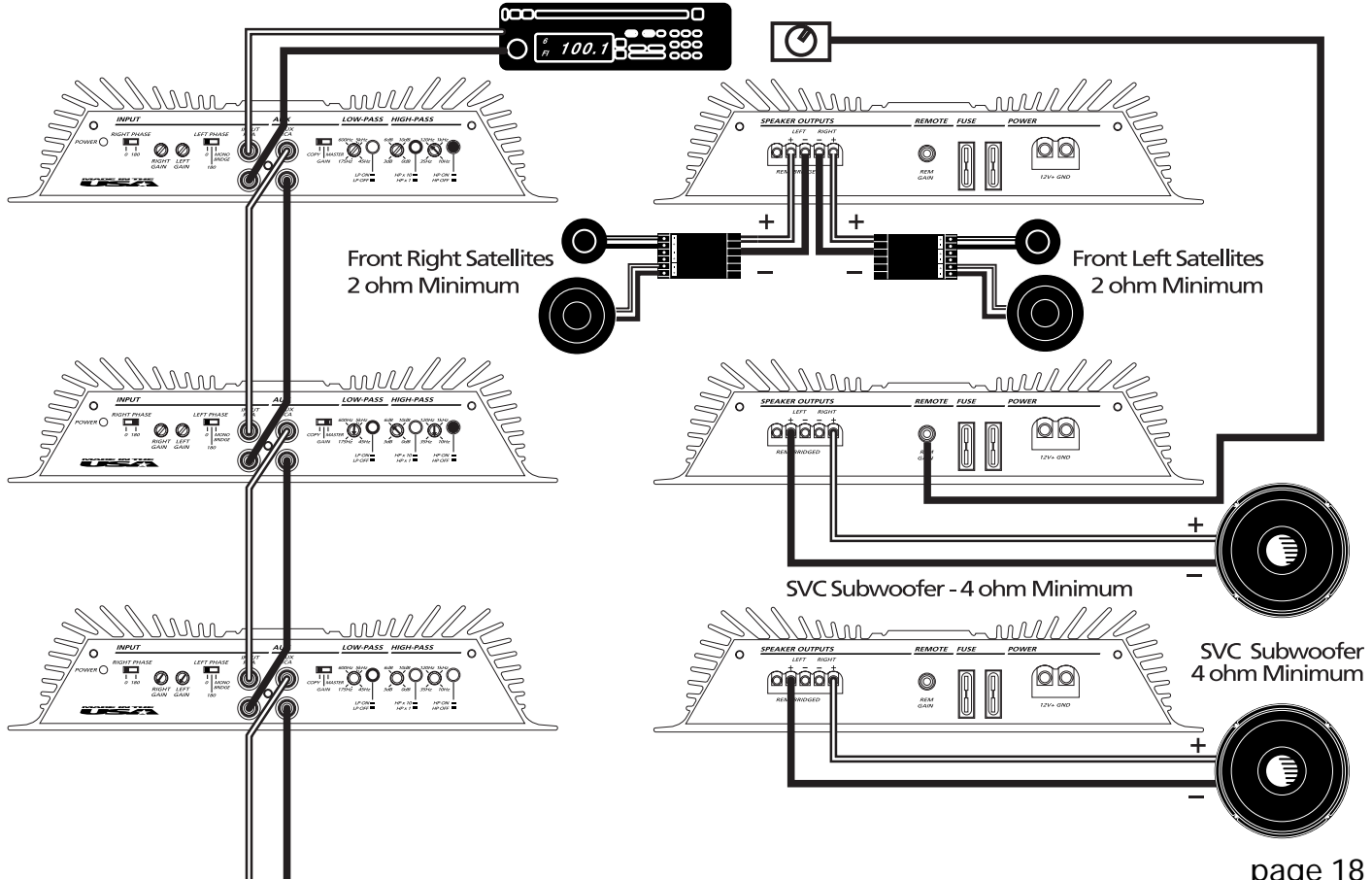

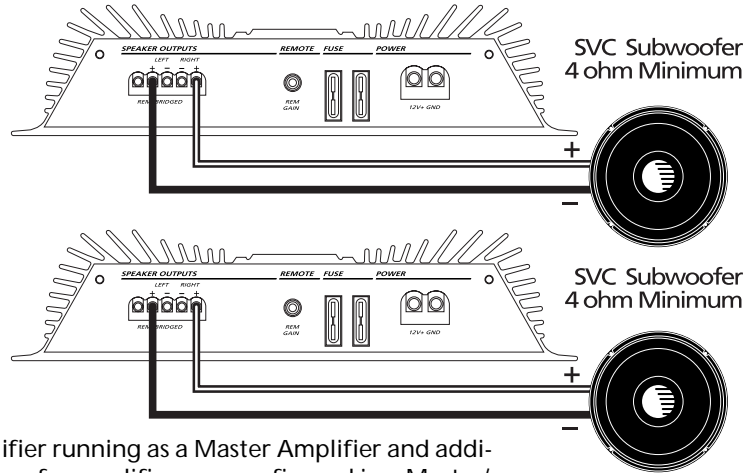
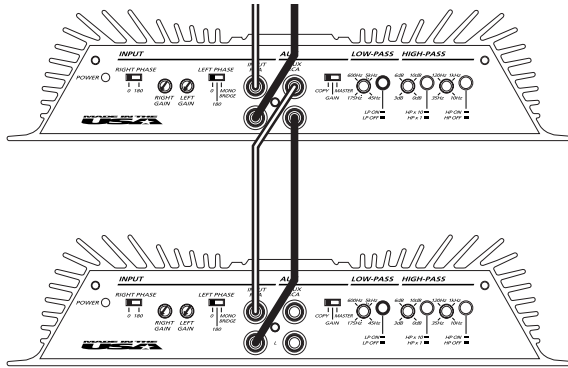

SYSTEM 5 has one amplifier driving front satellites, one amplifier running as a Master Amplifier and additional amplifiers running as Slave amplifiers to the master. The subwoofer amplifiers are configured in a Master/Slave configuration for absolute crossover and level matching.

AMPLIFIER 1

- Output is configured for high-pass operation.
- Left Phase switch set to 0°
- Right Phase switch set to 0°
- Gain controls can be set together or independently of each other

AMPLIFIER 2

- Output is configured for band-pass operation.
- The high-pass crossover is used as a subsonic filter with INTELLI Q.
- RCA inputs are connected to both left and right channels
- Left Phase switch set to 0°
- Right Phase switch set to 180°
- Gain controls must be set identically for both left and right channels.

AMPLIFIER 3, 4 & 5

- Output is configured for full range operation.
- RCA inputs are connected to both left and right channels
- Left Phase switch set to 0°
- Right Phase switch set to 0°
- Gain controls must be set to minimum positions

POWER CONNECTIONS

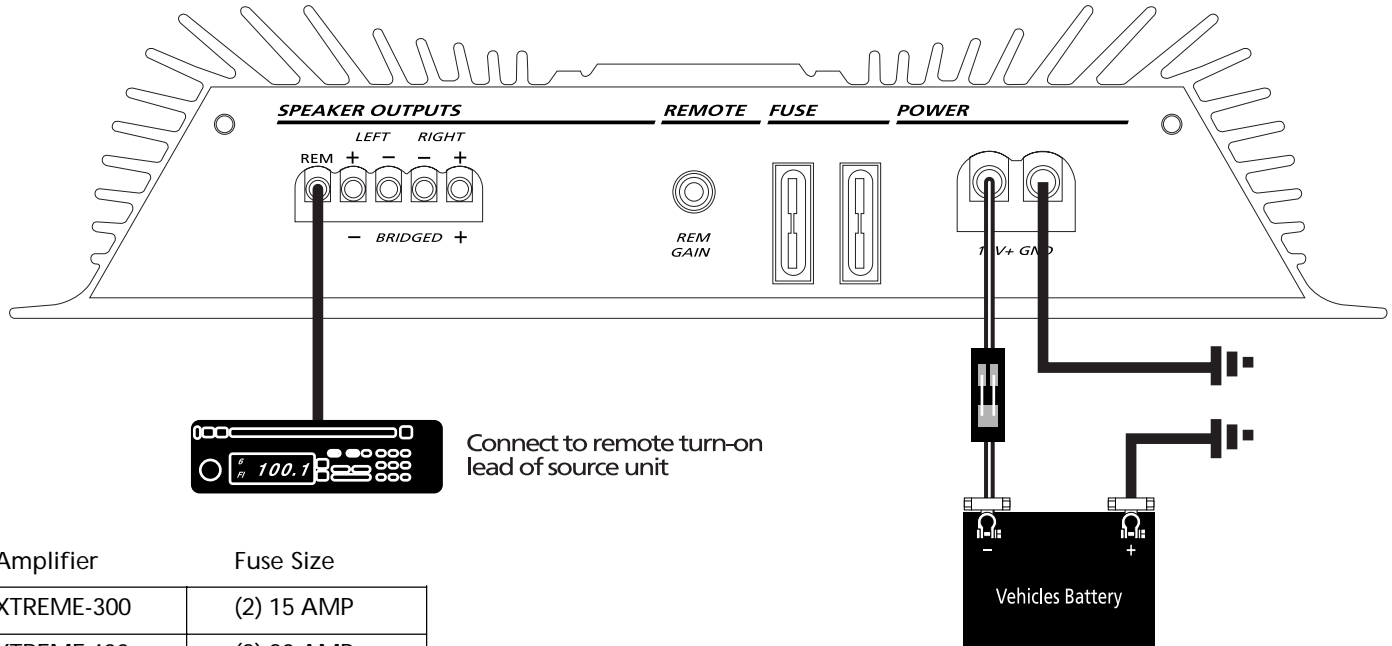

Amplifier	Fuse Size
XTREME-300	(2) 15 AMP
XTREME 400	(2) 20 AMP
XTREME 800	(2) 30 AMP
XTREME 1200	(6) 30 AMP

- Power connections made through a large 4 gauge removable terminal connector. (Dual 4 gauge connectors of the XTREME 1200)
- 4 Gauge power and ground wire recommended for optimal performance. (Dual 4 gauge connectors of the XTREME 1200)
- Minimum 8 Gauge power and ground cable is recommended for acceptable performance. (Use only 4 gauge power wire on the XTREME 1200).
- Connect 12V+ to the battery through fuse holder. This connection provides +12V main power to the amplifier.
- Power wire must be fused less than 18" from battery.
- Ground amplifier to a good chassis ground as close as possible to the amplifier.
- Connect REM terminal to remote turn-on lead from source unit. This connection provides +12V power to turn-on the amplifier.
- Add Extra Ground wire between the negative terminal of the battery and the chassis.

NOTE: The addition of a ground wire from the battery to the chassis of the vehicle improves the ability of the battery to supply power to the amplifier. This helps especially in newer vehicles, where the current delivery of the factory electrical system was designed only to accommodate electronics supplied by the auto manufacturer.

WARNING: The XTREME 1200 has two separate 4 gauge power and ground inputs. Both pairs of connections must use 4 gauge power wire for proper operation. Failure to do this may damage the amplifier and is not covered under warranty.

POWER CONNECTIONS XTREME 1200

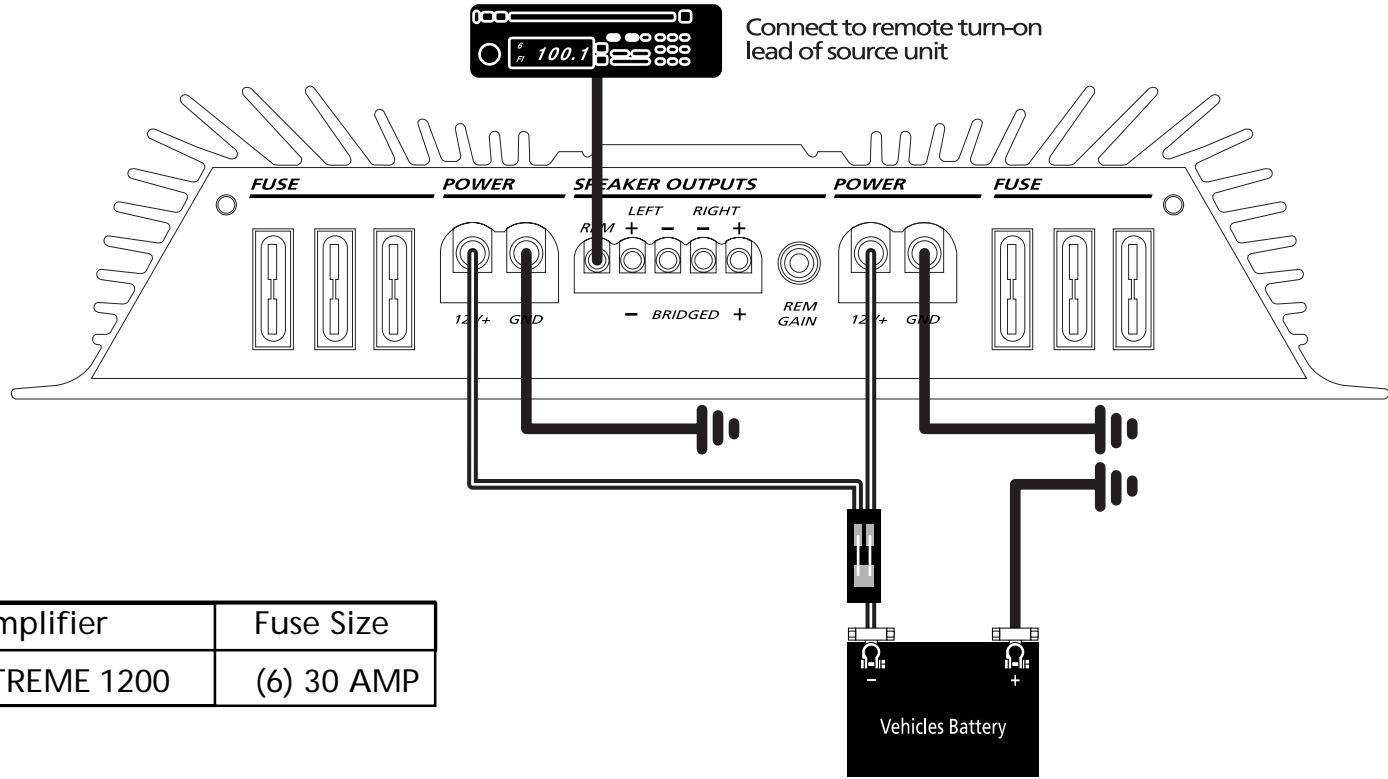

Amplifier	Fuse Size
XTREME 1200	(6) 30 AMP

- Power connections made through dual large 4 gauge removable terminal connector.
- Dual 4 Gauge power and ground wire required for proper performance.
- Connect 12V+ to the battery through power distribution and fuse holder. This connection provides +12V main power to the amplifier.
- Power wires must be fused less than 18" from battery.
- Terminate both grounds for amplifier to a good chassis ground as close as possible to the amplifier.
- Connect REM terminal to remote turn-on lead from source unit. This connection provides +12V power to turn-on the amplifier.
- Add Extra Ground wire between the negative terminal of the battery and the chassis. Either dual 4 gauge or single 1/0 gauge.

NOTE: The addition of a ground wire from the battery to the chassis of the vehicle improves the ability of the battery to supply power to the amplifier. This helps especially in newer vehicles, where the current delivery of the factory electrical system was designed only to accommodate electronics supplied by the auto manufacturer.

WARNING: The XTREME 1200 has two separate 4 gauge power and ground inputs. Both pairs of connections must use 4 gauge power wire for proper operation. Failure to do this may damage the amplifier and is not covered under warranty.

TWO CHANNEL STEREO CONFIGURATION

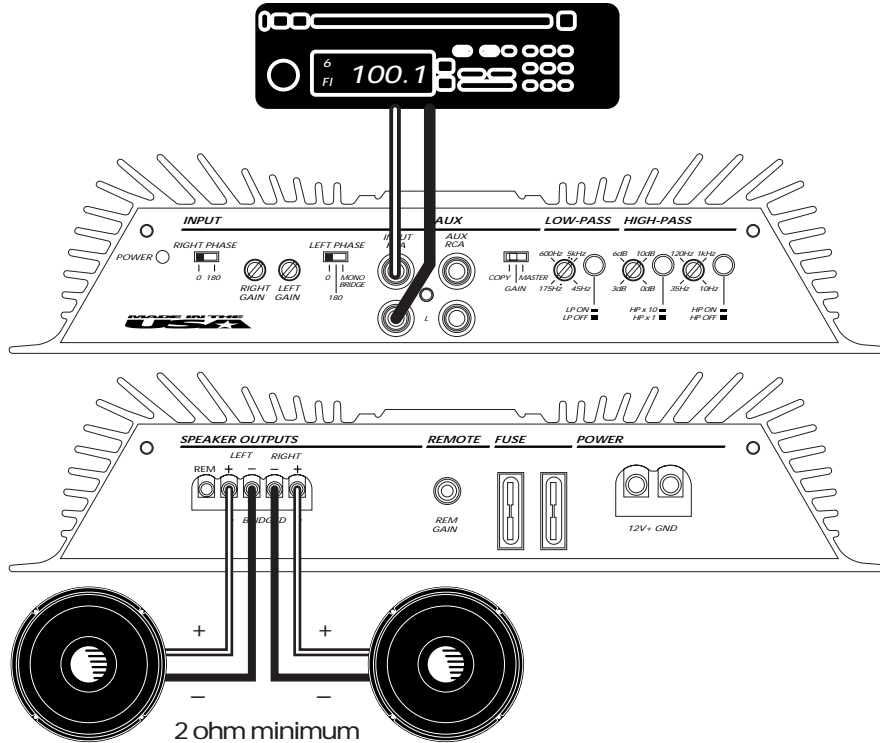

- Lowest Recommended Impedance is 2Ω Stereo.
- RCA inputs are connected to both left and right channels
- Left Phase switch set to 0°
- Right Phase switch set to 0°
- Gain controls can be set together or independently of each other
- Output can be configured for high-pass, low-pass, band-pass or full range operation.
- Output is configured either for stereo operation.

TUNING NOTE: The phase switches can be individually switched for improved sound quality. Try different phase switch positions for best sonic results. The high-pass crossover can be used as a subsonic filter with INTELLi Q. Configure the high-pass crossover for "LOW" frequency range operation and set according to instructions explained in the High-pass Crossover Section in this manual.

SUMMED BRIDGED CONFIGURATION

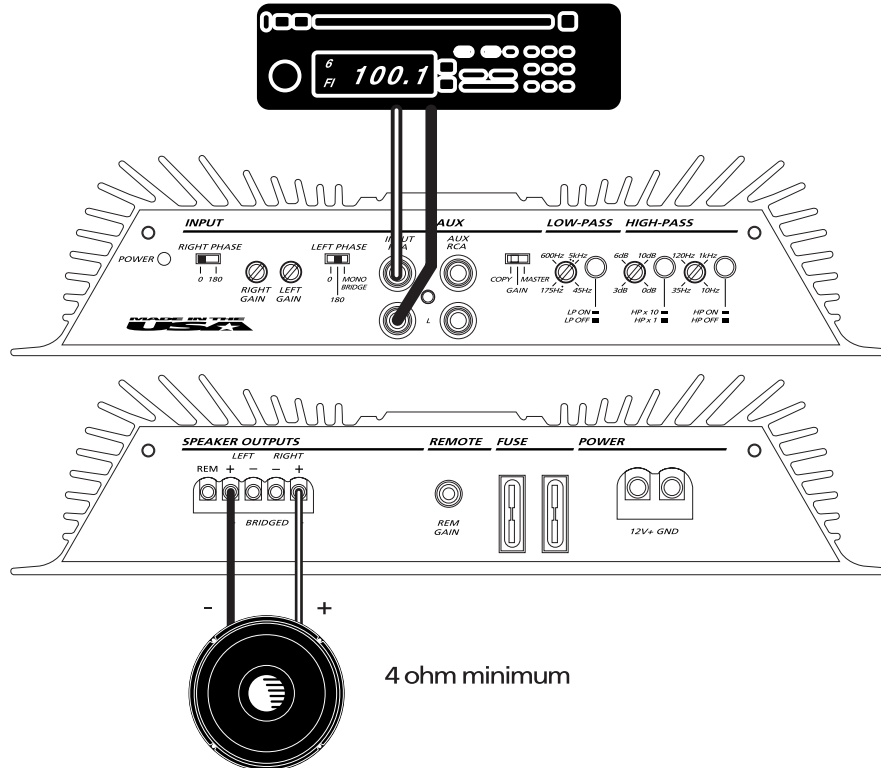

- Lowest Recommended Impedance is 4Ω bridged mono.
- RCA inputs are connected to both left and right channels
- Left Phase switch set to 0°
- Right Phase switch set to 180°
- Gain controls must be set identically for both left and right channels.
- Output can be configured for high-pass, low-pass, band-pass or full range operation.
- Output is configured summed bridged which is ideal for subwoofer applications..

TUNING NOTE: The phase switches can be individually switched for improved sound quality. In the summed bridged configuration the left and the right phase must be set opposite from each other in order to operate correctly. The high-pass crossover can be used as a subsonic filter with INTELLi Q. Configure the high-pass crossover for "LOW" frequency range operation and set according to instructions explained in the High-pass Crossover Section in this manual.

SINGLE CHANNEL BRIDGED CONFIGURATIONS

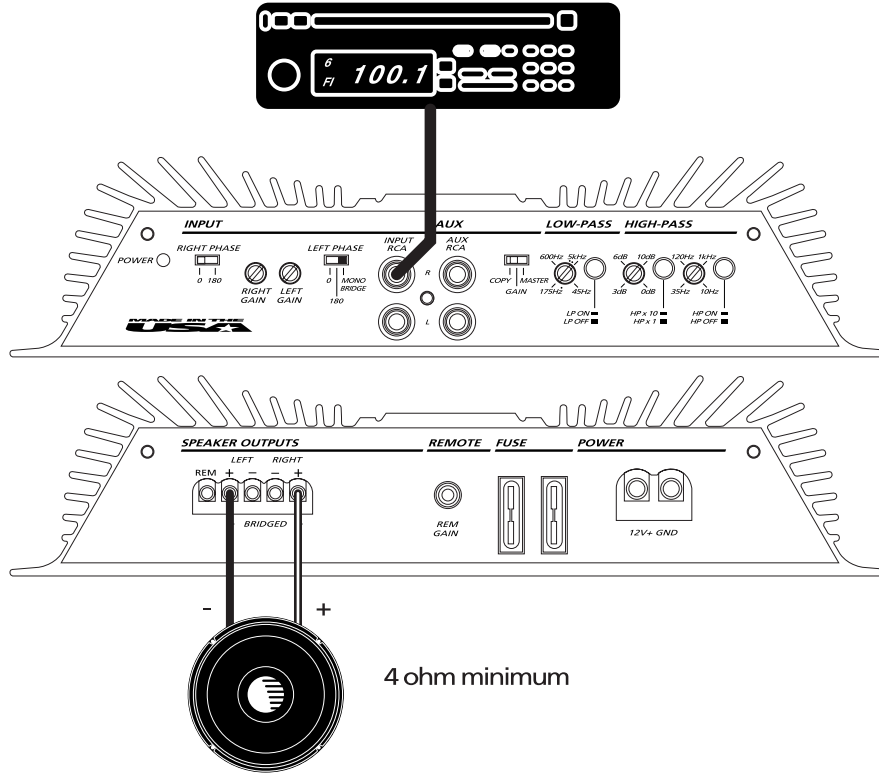

- Lowest Recommended Impedance is 4Ω bridged mono.
- Only the Right RCA input is used
- Right Phase switch set to 0°
- Left Phase switch set to “MONO BRIDGED”
- Right Gain control sets the level for the amplifier output.
- Output can be configured for high-pass, low-pass, band-pass or full range operation.
- Output is configured mono bridged which is ideal for separate left or right channel subwoofer applications..

TUNING NOTE: In the “MONO BRIDGED” configuration, the Right Phase control can be used to change the phase of the amplifier output. The right phase switches can be individually switched for improved sound quality. Try different phase switch positions for best sonic results. The high-pass crossover can be used as a subsonic filter with INTELLi Q. Configure the high-pass crossover for “LOW” frequency range operation and set according to instructions explained in the High-pass Crossover Section in this manual.

TRI-MODE THREE CHANNEL CONFIGURATION

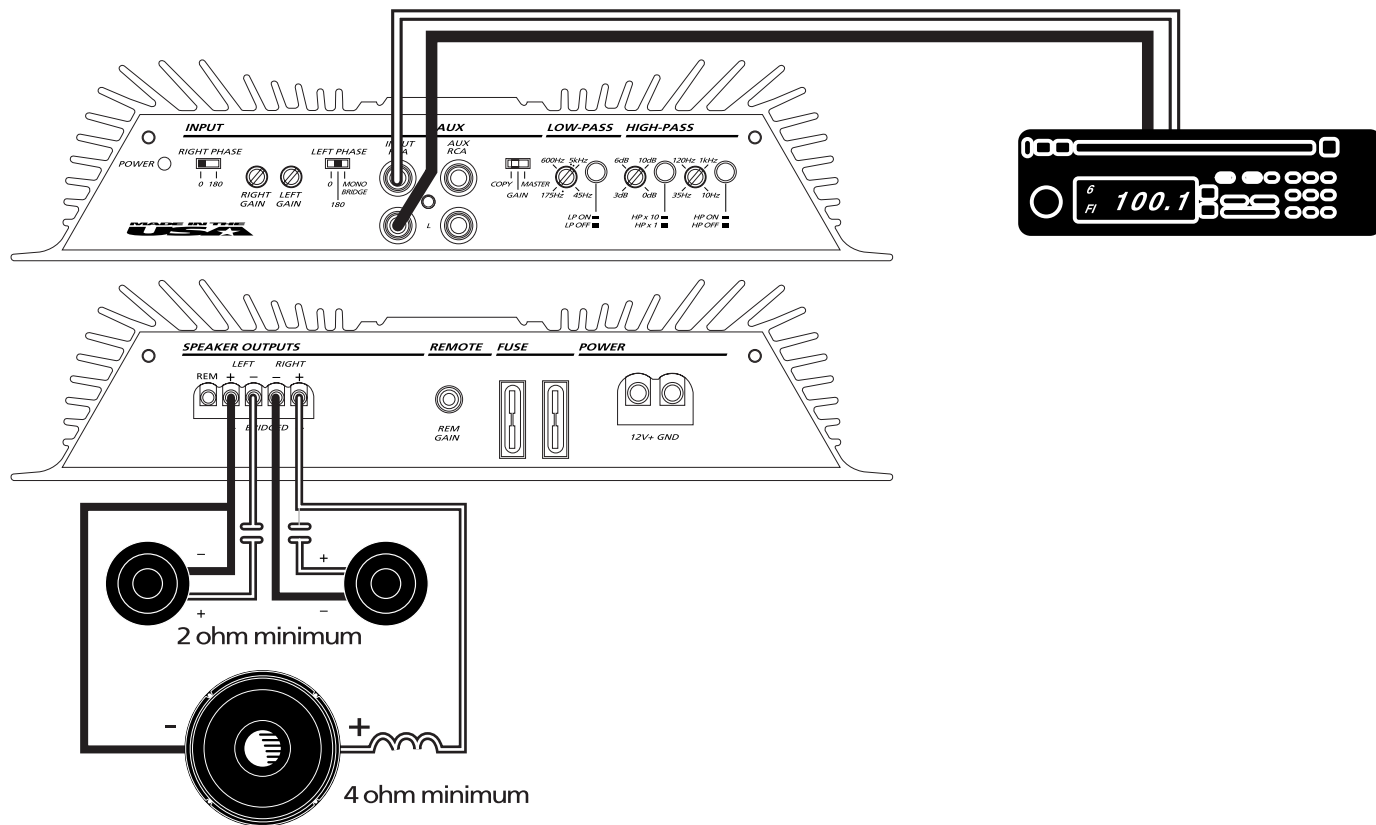

- Lowest Recommended Impedance is 2Ω stereo and 4Ω bridged mono.
- RCA inputs are connected to both left and right channels
- Left Phase switch set to 0°
- Right Phase switch is set to 180°, Speaker polarity on the right channel must be inverted to maintain proper speaker polarity.
- Gain controls must be set identically for both left and right channels.
- Output must be configured for full range operation.
- Passive crossover frequencies must not overlap.

WARNING: Failure to do so may result in damage to the amplifier.

- For optimum performance results, we recommend the use of the ORION CSX-TMC. This passive crossover is designed for 4Ω satellites and a single 4Ω subwoofer.
- Output is configured summed bridged, which is ideal for single subwoofer applications..

TUNING NOTE: The phase switches can be individually switched for improved sound quality. In the Tri-mode configuration the left and the right phase must be set opposite from each other in order to operate correctly. The high-pass crossover can be used as a subsonic filter with INTELLi Q. Configure the high-pass crossover for "LOW" frequency range operation and set according to instructions explained in the High-pass Crossover Section in this manual.

INPUT SECTION

The input section of the amplifier consists of separate phase switches that set output configuration, separate left and right gain controls and RCA inputs. The input section makes it easy to adapt this amplifier to most system configurations

PHASE SWITCHES

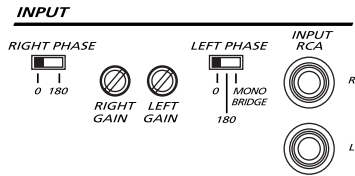

The XTREME amplifier has separate left and right phase control switches. There are six different setting combinations. Setting 1 is the factory configuration. Both left and right channels are in Phase. Both left and right gain controls are active.

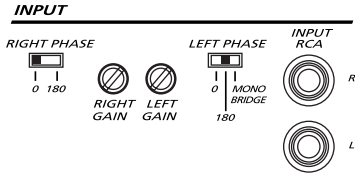

Setting 2 inverts the output of the right channel. The right channel is 180° out of phase from the left channel. Both left and right gain controls are active. This configuration is useful for Tri-mode operation. Additionally, inverting one channel of satellite speakers can focus imaging.

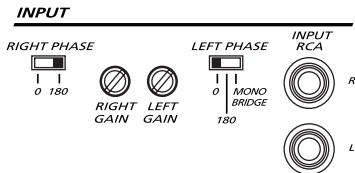

Setting 3 inverts the output of the left channel. The left channel is 180° out of phase from the right channel. Both left and right gain controls are active. This configuration is useful for Tri-mode operation. Inverting one channel of satellite speakers can focus imaging.

INPUT

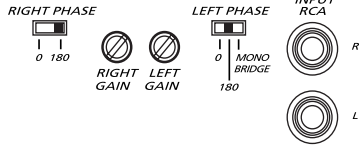

Setting 4 inverts the output of both the left and right channels. Both left and right gain controls are active. This configuration is useful for inverting one set of speakers like rear speakers in front/rear system to improve staging in a vehicle.

INPUT

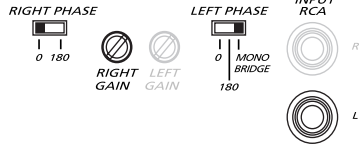

Setting 5 inverts the output of the left channel. The left channel is 180° out of phase from the right channel. Only the right gain control is active. This is the “MONO BRIDGED” output configuration. Right Phase control determines the phase of the output. When the Right Phase control is in the 0° position, the bridged output is in phase with the rest of the system.

INPUT

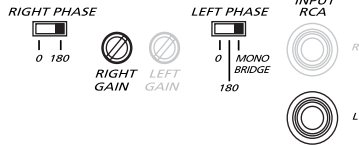

Setting 6 inverts the output of the bridged output. The mono bridged input is 180° out of phase from the rest of the system. Only the right gain control is active. This is the “MONO BRIDGED” output configuration. Right Phase control determines the phase of the output. When the Right Phase control is in the 180° position, the bridged output is out of phase with the rest of the system.

INPUT GAIN

INPUT

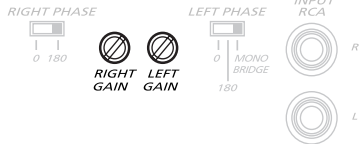

XTREME amplifiers have separate left and right level adjustments. The input sensitivity of these adjustments range from 200mV up to 5Vrms to easily integrate with any source unit both after market and OEM (Original Equipment Manufacturer) Refer to the Testing the System and the Adjusting the Sound of the System for detailed instructions on setting up the level controls.

INTERNAL CROSSOVER SECTION

LOW-PASS HIGH-PASS

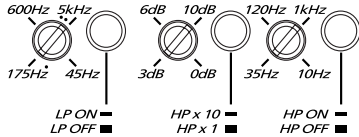

The crossover section of the XTREME amplifier is continuously variable and extremely flexible. There are eight different crossover configurations possible allowing high-pass, low-pass and band-pass configurations. New for ORION amplifiers is the INTELLI Q feature on the high-pass crossover. This circuit is designed to optimize the performance of ORION subwoofers in all types of enclosures.

When using ORION loudspeakers, minor deviations from the recommended frequency ranges can provide superior results depending on your speaker locations and your vehicle acoustics. Setting crossover frequencies higher than recommended will not cause damage and may provide superior sonic results depending on your system's performance goals. Refer to your loudspeaker owner's manual for assistance in choosing the proper crossover frequencies for your system.

WARNING!!! DO NOT set crossover frequencies lower than the speakers recommended operating range. This can cause driver failure that is not covered by manufacturer's warranty.

LOW-PASS CROSSOVER

LOW-PASS HIGH-PASS

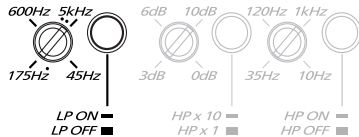

When the push button is in the "out" position, the low-pass crossover is bypassed.

LOW-PASS HIGH-PASS

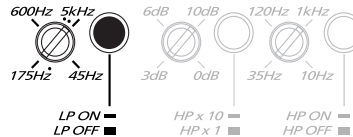

When the push button is in the "in" position, the low-pass crossover is active. The low-pass crossover is continuously variable from 45 Hz to 5 kHz.

FINE TUNING THE LOW-PASS CROSSOVER

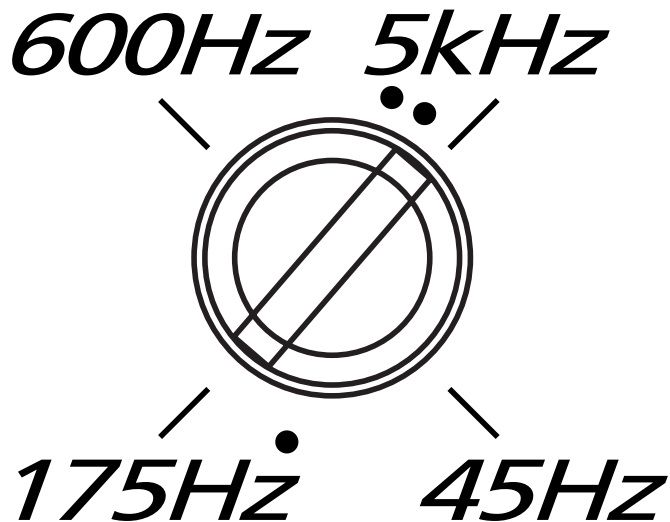

The crossover section is marked at four frequency points for ease of system adjustment. These points are 45 Hz, 175 Hz , 600 Hz and 5,000 Hz. Specific crossover points can be chosen based on the recommended operational bandwidth of your speakers.

There are three small dots on the frequency range dial. These dots represent commonly used ORION crossover frequencies. These crossover frequencies are 85 Hz, 2,500 Hz and 3,500 Hz respectively.

HIGH-PASS CROSSOVER

LOW-PASS **HIGH-PASS**

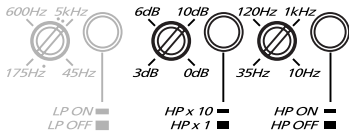

When both push buttons are in the “out” position, the high-pass crossover is by-passed.

MID AND TWEETERS

LOW-PASS **HIGH-PASS**

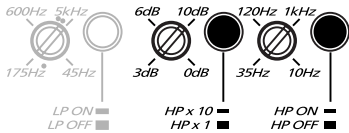

When both push buttons are in the “in” position, the high-pass crossover is active in the “HIGH” frequency range. The high-pass crossover is continuously variable from 100 Hz to 10 kHz. This setting is used for crossing over midrange and tweeter speakers. Set the INTELLI Q level to “0 dB.” NOTE: When the high-pass crossover is in the “HIGH” frequency range, the frequency indicators represent 1/10 of the crossover frequency. For example, 35Hz = 350Hz.

WARNING!!!

When using the crossover in the “HIGH” range, it is not recommended to use the INTELLI Q as it may potentially damage your midrange or tweeter speakers.

HIGH-PASS WOOFERS

LOW-PASS **HIGH-PASS**

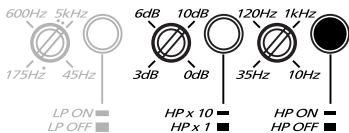

When only the push button to activate the high-pass crossover is in the “in” position, the high-pass crossover is active in the “LOW” frequency range. The high-pass crossover is continuously variable from 10 Hz to 1 kHz. The high-pass crossover is now optimized for use as a subsonic filter for subwoofers. Additionally, boost can be added at the high-pass crossover frequency for improved bass output while still protecting the woofer from excessive excursion. The INTELLI Q adjustment allows up to 10 dB of boost at the crossover frequency. Care must be taken when setting the INTELLI Q at or near the maximum boost.

FINE TUNING THE HIGH-PASS CROSSOVER "HIGH RANGE"

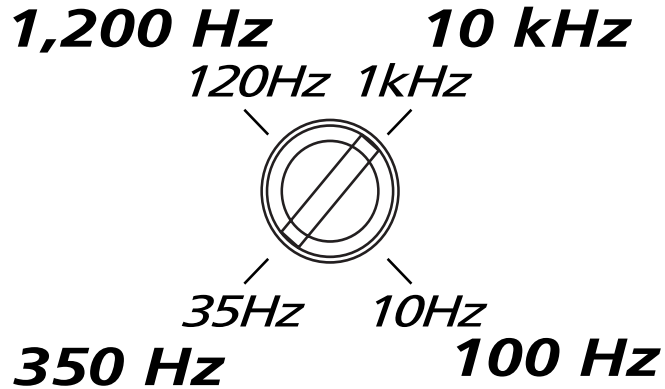

The crossover section is marked at four frequency points for ease of system adjustment. These points are 10 Hz, 35 Hz, 120 Hz and 1 kHz. Specific crossover points can be chosen based on the recommended operational bandwidth of your speakers.

Note: When the high-pass crossover is set in the "HIGH" frequency range, the corner frequencies are 100 Hz, 350 Hz, 1.2 kHz and 10 kHz respectively.

ADJUSTING INTELLI Q

Boost Levels	0dB	+3dB	+6dB	+10dB
Enclosure Type :				
Infinite Baffle	Acceptable, No Problems. Tune above Fs of woofer.	High X-Max Drivers. Tune above Fs of woofer.	Not Recommended	Not Recommended
Sealed	Acceptable, No Problems. Tune above Fs of woofer.	Acceptable, No Problems. Tune above Fs of woofer.	High X-Max Drivers. Tune above Fs of woofer.	Not Recommended
Vented	Acceptable No Problems. Tune to Port frequency.	Acceptable No Problems. Tune to Port frequency.	Acceptable No Problems. Tune to Port frequency.	High X-Max Drivers. Tune to port frequency.
Sealed Bandpass	Acceptable No Problems. Tune above Fs ofwoofer.	Acceptable No Problems. Tune above Fs ofwoofer.	High X-Max Drivers Drivers. Tune above Fs ofwoofer.	Not Recommended
Vented Bandpass	Acceptable No Problems. Tune to port frequency.	Acceptable No Problems. Tune to port frequency.	Acceptable No Problems. Tune to port frequency.	High X-Max Driver. Tune to port frequency.
Aperiodic	Set crossover to Fs of woofer.	Set crossover to Fs of woofer.	Set crossover to Fs of woofer.	Not Recommended

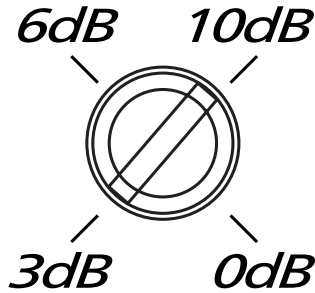

Incorporated in the high-pass crossover, INTELLi Q maximizes the performance of a subwoofer. The high-pass subsonic filter removes unwanted bass output from the woofer, increasing the output of a subwoofer by as much as 3 dB due to the increased mechanical power handling. Depending on the enclosure, using INTELLi Q can increase the low frequency response by an additional 10dB!!! The boost level is identified by the corner markings. Acceptable boost levels are determined by the type of enclosure used and the woofer's excursion capability. Listed below are recommended boost levels for different enclosure designs.

"Q" BOOST FILTER RESPONSE

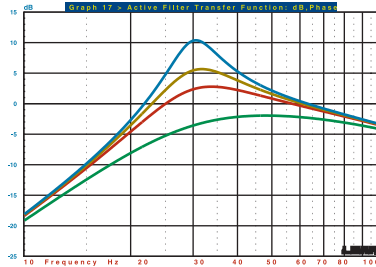

On the left is a frequency response of the high-pass filter set to 30 Hz.

On the right frequency response of the high-pass filter set to 20Hz.

INTELLi Q levels of 0dB, 3dB, 6dB and 10dB are displayed respectively.

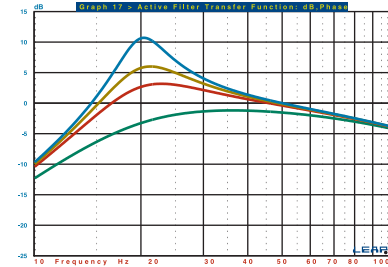

INFINITE BAFFLE EXAMPLE HIGH-PASS SET @ 30Hz

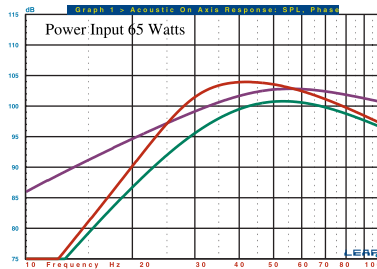

By removing low frequency signal which the woofer cannot produce, the woofer can play its capable range louder. The first example is an infinite baffle situation. The left Graph displays the frequency response of a 12 inch woofer in an infinite baffle application without the high-pass filter,

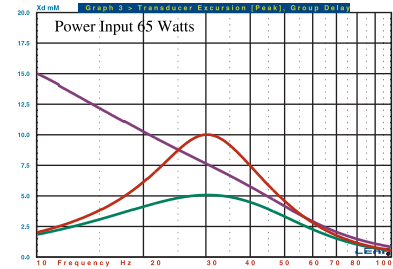

with the filter and with the filter and the INTELLI Q set to +3dB. As you can see with +3dB of boost and the high-pass filter set to 30Hz, the woofer has more output down to 25Hz and less overall excursion when compared to the non-high-pass response. Maximum physical excursion capability of the woofer is 15mm.

SEALED EXAMPLE HIGH-PASS SET @ 20Hz

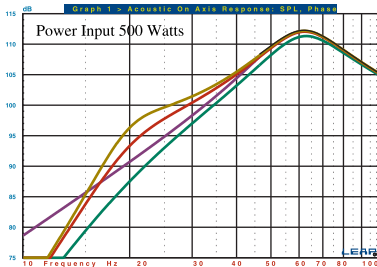

This sealed example is the same 12 inch woofer in the recommended sealed enclosure. Up to 6 dB of boost is capable at 20 Hz was used. With +6dB of boost, the woofer has more output down to 15 Hz.

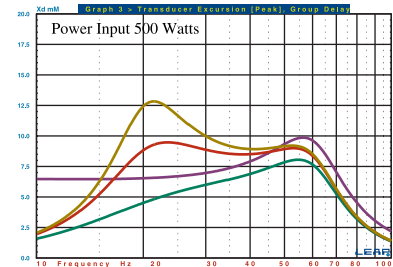

SEALED EXAMPLE HIGH-PASS SET @ 30Hz

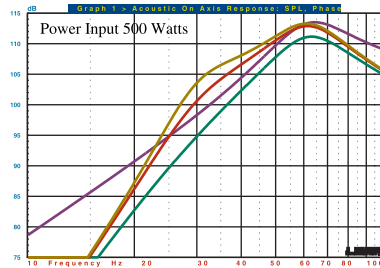

In this example, the frequency has been increased to 30 Hz. Up to 6 dB of boost is capable at this frequency. With +6dB of boost, the woofer has more output down to 23 Hz. Overall usable output is increased.

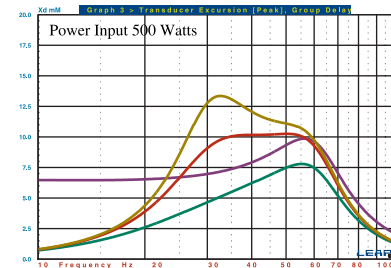

VENTED EXAMPLE HIGH-PASS SET @ 30Hz

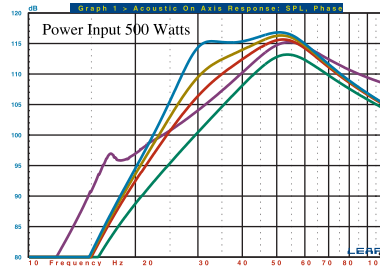

Vented enclosure benefit most from the INTELLi Q. Up to 10 dB of boost is capable at the box tuning frequency of 30 Hz. With +10dB of boost, the woofer has more output down to 22 Hz. The excursion below the tuning frequency has been greatly reduced.

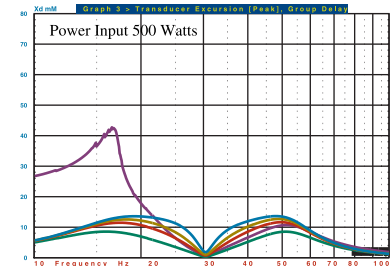

AUXILIARY OUTPUT SECTION

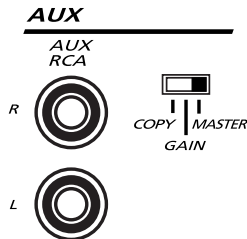
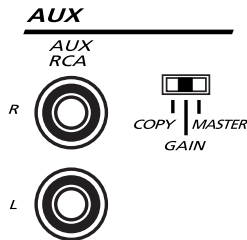
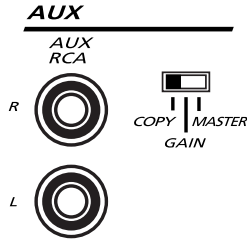

The auxiliary outputs offer ORION amplifiers easy unlimited system expansion . Routing signal from a source unit, pre-amplifier or equalizer is a matter of routing RCAs into the RCA Inputs and out the AUX outputs to the next XTREME or HCCA amplifier in the signal chain. When the switch is in the “COPY” position, the AUX RCA is an identical copy of the RCA inputs. The signal passes through a buffer stage so that an infinite number of XTREME amplifiers can be daisy chained without signal loss or overloading of the source unit. This maximizes the amplifier output and minimizes the potential for system noise.

When the switch is in the “GAIN” position, the AUX RCAs are buffered through the gain stage of the amplifier. When the first amplifier in the signal chain is set this way, a remote gain controller can be installed in the amplifier and act as a “PRE-AMP” controlling the overall level of the system. Following amplifiers can be configured in either the “COPY” or “MASTER” configuration for an infinite number of XTREME or HCCA amplifiers in the signal chain without signal loss or overloading of the source unit. This maximizes the amplifier output and minimizes the potential for system noise.

When the switch is in the “MASTER” position, the AUX RCA are buffered through the gain stage of the amplifier and filtered through the crossover section of the amplifier. When set this way, one amplifier’s gain and crossover setting can be sent to other amplifier down the signal chain. This can be useful for configuring multiple subwoofer amplifiers easily in a large SPL system. A Remote gain controller will also control the level of all the amplifiers following the amplifier configured in this master setting. An infinite number of XTREME or HCCA amplifiers in the signal chain without signal loss or overloading of the source unit. This maximizes the amplifier output and minimizes the potential for system noise.

Remote Gain Section

REMOTE



**REM
GAIN**

The remote gain port provides easy remote access to the internal gain structure of the XTREME power amplifier. The RGC-1 plugs into the amplifier via the 1/8" mini jack plug. The RGC-1 can be installed in the front of the vehicle to control the amplifier gain level. The RGC-1 can be used as a bass level control when used on an amplifier dedicated to subwoofers

INSTALLATION TIPS

TOOLS FOR THE TRADE

Listed are the majority of the tools required to perform the installation. Having the proper tools will make the installation that much easier. Some of these tools are necessities. Some make the job much easier.

- marking pen
- electric drill with assorted drill bits
- utility knife
- Phillips and flat blade screw drivers
- pliers (standard and needle nose)
- wire brush or sandpaper for chassis grounding
- solder iron and solder
- grommets
- heat shrink tubing
- nylon tie straps
- volt-ohm meter (optional)
- wire cutters
- wire crimpers
- wire strippers
- RTA (real time analyzer)
- Reference CD with 1 kHz Sine Wave at 0dB level (all bits high)

CHOOSING MOUNTING LOCATIONS

The location of your XTREME amplifier will depend on several important issues. Due to the low profile size of the XTREME amplifiers, there are many possible installation locations that will yield satisfactory amplifier performance. Always mount the amplifier in a place that protects the amplifier from the elements. In addition, mount the amplifier on a stable, flat mounting surface. As with any amplifier, there are several possible mounting locations and configurations that can be optimal. We will cover the most obvious of situations.

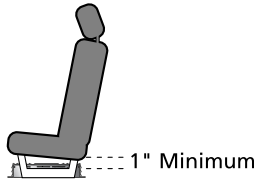

PASSENGER COMPARTMENT MOUNTING

If you are going to mount the amplifier in the passenger compartment, make sure you have adequate room for ventilation. The XTREME amplifiers have been designed to make possible under seat mounting. When mounting your amplifier under a seat or similar area, keep a minimum of 1" of clearance around the amplifier for adequate cooling.

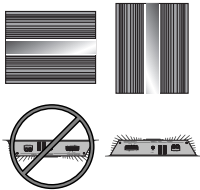

TRUNK COMPARTMENT MOUNTING

Mounting the XTREME amplifier in the trunk provides excellent performance as long as you do not mount the amplifier upside down or restrict the airflow around the heatsink of the amplifier. For optimal results, mount the amplifier with the cooling fins in the vertical position. This type of mounting will yield the best cooling due to the convection effect of the amplifier chassis.



ENGINE COMPARTMENT MOUNTING

Do not mount the XTREME amplifier in the engine compartment. The amplifier was not designed to endure the harsh environment of the exterior elements.

GENERAL PRECAUTIONS AND INSTALLATION TIPS

Caution: Be careful not to cut or drill into gas tanks, fuel lines, brake lines, hydraulic lines, vacuum lines, or electrical wiring when working on your vehicle.

Disconnect the vehicle's ground wire at the battery before making or breaking connections to the audio system's power supply terminals.

Do not use the XTREME Amplifier unmounted. Failing to securely mount the amplifier can result in damage or injury, particularly in the event of an accident. An unmounted amplifier acts like a heat-seeking missile in the event of a crash. Never mount a XTREME Amplifier where it might get wet. Mount the XTREME amplifier so the wire connections will not be pulled. Route the wires where they will not be scraped, pinched or damaged in any fashion.

The +12V power supply wire must be fused as close as possible to the battery terminal, ideally within 18". Use the recommended fuse size or circuit breaker listed in the POWER CONNECTIONS section of this manual.

If you need to replace the fuse plugged into the side of the XTREME amplifier, replace the fuse with the same size ATC type fuse that came with the amplifier. If you are not sure as to the correct value, refer to the POWER CONNECTIONS section of this manual for details. Using a higher current fuse may result in damage to the XTREME amplifier which is not covered under warranty.

NOTE: Make sure all the equipment in the system is turned off when making or breaking connections to the XTREME input RCAs or speakers terminals. Turn on the system and slowly turn up the volume control only after double checking all wire connections.

Power for systems with a single XTREME amplifier can be supplied by most any automotive electrical system. Systems with multiple amplifiers may require a higher capacity battery, alternator or the use of a storage capacitor. WE strongly recommend the use of both a *WIRED!* Transient Storage Capacitor and a MBR70 with an extra battery in larger stereo systems.

XTREME amplifiers generate a certain amount of heat as part of its normal operation. Be sure the area around the cooling fins is unobstructed to allow adequate air circulation. Remember, beach blankets, last weeks laundry, school books and homework papers located on top of the amplifier, does not improve air flow.

STEP BY STEP INSTALLATION

- Step 1 Determine the location for the amplifier. Refer to the Mounting Locations section in this manual for detailed information.
- Step 2 Decide on the system configuration for your amplifier. For system suggestions, refer to the System Planning section of this manual.
- Step 3 Run all the wires from the amplifier location to the speakers, source unit and battery. Do not connect the battery at this time. Be sure to run RCAs, power and speaker wires away from factory electrical wires and system as they pose a great potential for induced system noise.
- Step 4 Pre-drill amplifier mounting holes. Be sure to "think before you drill". Gas tanks, fuel lines, and other obstructions have a nasty way of hiding themselves. For best results use a marking pen to mark the mounting holes and pre--drill these holes with a standard 1/8" drill bit.
- Step 5 Mount the amplifier. Make sure the amplifier is mounted on a flat surface. If this is not possible, do not over tighten the screws such that the chassis of the amplifier is twisted or bent.
- Step 6 Turn the vehicle's key switch to the off position.
- Step 7 Disconnect the vehicle's battery ground terminal.
- Step 8 Connect the RCA and speaker wires to the amplifier. Check the quality of your speakers and signal connections. This will determine the ultimate performance of your ORION amplifier. Refer to the Installation quick reference section of this manual for correct wiring instructions.
- Step 9 Connect power wires to the amplifier. At this time do not connect the fuse at the main battery.
- Step 10 Reconnect the ground terminal to the battery.
- Step 11 Set crossover and signal routing configurations. Refer to the signal routing switches and the internal crossover configuration sections of this manual for detailed instructions.
- Step 12 Once satisfied that all connections and settings are correct, install fuse at location near the vehicle's battery and proceed to the testing the system section of this manual.

WARNING!!!! Never exceed the recommended fuse size of this amplifier. Failure to do so will result in the void of your warranty.

TESTING THE SYSTEM

After you have completed the installation, you need to test the system. This will help ensure years of trouble free operation. Please refer to the listed steps below when testing the sound of your ORION XTREME system.

- Step 1 Check all the wiring connections to be sure they are correct and secure.
- Step 2 Turn the signal source volume control down all the way. Set any tone controls to their flat or defeated positions. This includes the loudness control.
- Step 3 Turn the level controls of the amplifier to their minimum positions.
- Step 4 Turn the source unit on. Check to see if the remote power LED located on the connection side of the amplifier is on. If not, please refer to the power connections section and the trouble shooting section of this manual for instructions.
- Step 5 If using a aftermarket source unit, turn the level controls of the amplifier about one quarter of a turn. Slowly increase the volume level of the source unit to so that you can hear the output of the system. If no sound is heard or if the output is distorted, turn the system off immediately. Refer to the power connections section and the trouble shooting section of this manual to solve your installation problems
- Step 6 Check to make sure the output for each channel is correct. If the active crossovers are used, check to make sure that each output is correct from the amplifier. When using active crossovers on midrange and tweeters, do not use crossover frequencies lower than recommended. If the system is not configured properly, refer to the internal crossover section of this manual and take corrective action.
- Step 7 If the output is clear and undistorted, continue to the adjusting the sound of the system section of this manual.

ADJUSTING THE SOUND OF THE SYSTEM

Once you have checked the system's operation, adjust the sound of the system. Adjusting the sound of the system is accomplished by setting the level controls and adjusting the internal crossovers.

- Step 1 Turn the signal source volume control down all the way. Set any tone controls to their flat or defeated positions. This includes the loudness control.

- Step 2 Turn the level controls of the amplifier to their minimum positions.
- Step 3 Choose music with high dynamic content that you like, that you are familiar with and will be most often used in the system.
- Step 4 Turn the unit up to its highest undistorted output level. If you lack test equipment, this point occurs between 3/4 to full volume depending on the quality of your source unit. Listen for any audible distortion, if any distortion is audible, reduce the volume of the source unit until you have an undistorted output. Leave the volume control at this position during your system tuning.
- Step 5 While listening to your chosen dynamic music, turn up the level control corresponding to the midrange output until you hear slight distortion and turn back the level control slightly for an undistorted output. Depending on your system, the midrange and tweeter output may be on the same output channels.
- Step 6 Turn up the level control corresponding to the tweeter output until you hear slight distortion and turn back the level control slightly for an undistorted output. Depending on your system the midrange and tweeter output may be on the same output channels.
- Step 7 Fine tune the crossover setting and output level between the midrange and tweeters. Refer to the internal crossover configuration section of this manual for detailed instructions.
- Step 8 Repeat Steps 5-7 for the rear speakers. If you do not have rear speakers continue to Step 10.
- Step 9 Set levels between the midrange and tweeters for optimum front/rear balance.
- Step 10 Turn up the level control corresponding to the woofer output until you hear slight distortion and turn back the level control slightly for an undistorted output.
- Step 11 Fine tune the crossover setting and output levels between satellite speakers and the woofers. Refer to the internal crossover configuration section of this manual for detailed instructions. If using an RGC-1, adjust the level to match the output of the woofer to match the sonic requirements of the system.
- Step 12 Enjoy your ass kickin' ORION sound system.

TROUBLE SHOOTING TIPS

SYMPTOM	PROBABLE CAUSE	ACTION TO TAKE
No output	Low or no remote turn-on input	Check remote turn-on voltage output at amplifier and fix as needed
	Fuse blown	Check power wire integrity and check for speaker shorts. Fix as needed and replace fuse
	Power wires not connected	Check power wire and ground connections and fix or replace as needed
	Audio input not connected	Check RCA connections and fix or replace as needed
	Speaker wires not connected	Check speaker wires and fix or replace as needed
	Speakers are blown	Check system with known working speaker and fix or replace speakers as needed
Audio cycles on and off Distorted output	Thermal protection engages when amplifier temperature exceeds 90°C (190°F)	Make sure there is proper ventilation for amplifier and improve Heatsink ventilation as needed
	Loose or poor audio input	Check RCA connections and fix or replace as needed
	Loose power connections	Check power wire and ground connections and fix or replace as needed
	Amplifier level sensitivity set too high. Exceeding maximum capability of amplifier	Readjust gain. Refer to Adjusting the sound of the system section of this manual for detailed instructions
	Impedance load to amplifier too low.	Check speaker impedance load, if below 2Ω stereo or 4Ω mono. Rewire speakers to achieve a higher impedance
	Shorted speaker wires	Check speaker wires connections and fix or replace as needed

SYMPTOM	PROBABLE CAUSE	ACTION TO TAKE
Distorted output continued...	Speaker not connected to properly	Check speaker wiring and fix or replace as needed. Refer to the amplifier speaker connections section of this manual for detailed instructions
	Internal crossover not set properly	Readjust crossovers. Refer to the internal crossover section of this for speakers manual for detailed instructions
	Speakers are blown	Check system with know working speakers and fix or replace as needed
Poor bass response	Speakers wired with wrong polarity causing cancellation at low frequency	Check speaker polarity and fix as needed
	Crossover set incorrectly section of this manual for detailed instructions	Reset crossovers. Refer to the internal crossover
	Impedance load at amplifier is too low.	Check speaker impedance load, if below 2Ω stereo or 4Ω mono Rewire speakers to achieve a higher impedance
Battery fuse blowing	Short in power wire or incorrect power connections.	Check power and ground connections and fix or repair as needed
	Fuse used is smaller than recommended	Replace with proper fuse size
	Too much current being drawn	Check speaker impedance load, if below 2Ω stereo or 4Ω mono rewire speakers to achieve a high impedance Check power and ground connections and fix or repair as needed
Amplifier fuse blowing	Too much current being drawn	Check speaker impedance load, if below 2Ω stereo or 4Ω mono rewire speakers to achieve a high impedance and replace with recommended size fuse
		Check power and ground connections and fix or repair as needed
	Fuse used is smaller than recommended	Replace with proper fuse size
	Impedance load at amplifier too low.	Check speaker impedance load, if below 2Ω stereo or 4Ω mono Rewire speakers to achieve a higher impedance
	Speaker is blown with shorted outputs	Check system with know working speakers and fix or replace as needed

AUTOSOUND 2000 TROUBLESHOOTING TIPS

QUICK CHECK FOR TROUBLESHOOTING CAR AUDIO SYSTEMS

Preface:

All audio systems exhibit noise; however, if the level of noise is low enough, and the signal level high enough, noise should not be a problem. This means that it is very important that the signal level throughout the system be optimized BEFORE dealing with your noise problem. Using a scope (or a small portable amplifier) and Track 99 (1kHz at all high bits) of Autosound 2000's CD #101, or tracks 24 through 29 of Autosound 200's CD #102, adjust the system so that when the maximum usable signal level of the deck is fed into the system, all the preamp level components clip at the same time. However, we recommend up to as much as a 3:1 voltage overlap with the power amplifiers; i.e. an amplifier with a 2 volt minimum sensitivity can be driven by up to 6 volts of signal.

Noise Overview:

Car audio electrical accessories are notorious for interfering with car audio systems. The interference commonly arises from three areas:

- 1) Power line noise (5%), which can be attenuated with in-line noise filters,
- 2) Inadequate power supply isolation (45%), which can be cured with transformer signal coupling, additional isolated power supplies, or changing out components, or
- 3) Inductive interference (45%) - Including loop area inductive noise picked up by the signal cables - which can be remedied by relocating or rewiring components, rerouting signal cables, or using twisted cable or balanced transmission systems.

AUTOSOUND 2000 1-2-3 METHOD OF LOGICAL TROUBLESHOOTING

- I. MUTE THE AMP(S). Insert a muting plug (shorted male RCA connector) into each amplifier channel. Turn up the amp sensitivity. Start the car and turn on the headlights, air conditioning, brake lights, etc. Listen for noise in each speaker. Be very picky here!
 - A. If still noisy, substitute a small test speaker with short leads for the speakers, crossovers, and speaker leads in the car. If still noisy, substitute an isolated power supply (120 VAC to 13.8 VDC bench supply or a small motorcycle battery) for the car's alternator. If the amplifier is noisy with the test speaker, you have a BAD amp. Send it in. It really doesn't matter if it is quiet or noisy while running on the isolated supply because you have a BAD amp. Send it in for repair and if it was quiet on the isolated supply, indicate so on the repair tag.

- B. If your muted amp is quiet, you've just joined 99.5% of car audio. Amps are usually very clean and do NOT pick up unwanted noise! Continue on to Step II.
- II. DECK TO AMP. Using a new set of signal cables, connect one channel from the output of the deck directly into one channel of your clean amp. Run the cables outside the car and as far away as possible from the metal of the car. (For noise purposes, consider a 2" thick cushion of electromagnetic energy emanating from every metal surface in the car.)
 - A. If still noisy, congratulations, in all probability your equalizer, electronic crossover, DSP whatchamacallit, are just fine. This means that you can't get your deck playing quiet with your amp, right? go to Step III.
 - B. If all is quiet, congratulations, in all probability your deck and amplifier(s) are fine - you obviously have a problem with your equalizer, electronic crossover, DSP, etc. Skip on down to "Time for the Processors."
 - III. MOVE THE DECK. If you're at this step, it is time to turn your system into an "amplified deck" by temporarily relocating the deck right ON-TOP of the clean amplifier. Then using very, very short signal cables, connect the output of the deck into the input of the amp and test for noise. Play a zero bit track - silence - and make sure all is completely quiet.
 - A. If still noisy, you're in a heap of trouble, We suggest that you try another deck and give us a call so that we can put your name into the record books. It's a bad car audio day for you.
 - B. If the deck is quiet, then congratulations, you're on your way to a successful installation. It is now time to slowly, methodically, reinstall the deck back into its final position. Test for noise each step of the way. If the noise returns, suspect the signal cables, forget shielding because it will have only a very, minimal effect within the audio band. We highly suggest using twisted pair cables or a balanced transmission system for cable induced noise.

TIME FOR PROCESSORS:

By the end of step III, you should have the deck playing quietly with the amp, with the quiet cables quietly routed. so it's time to add the signal processors - one at a time - back into the system. Simply repeat steps II and III with the equalizer, then the electronic crossover, etc. However, before MOVING-THE-SIGNAL-PROCESSORS to the amplifier, we highly suggest that you supply power to the noisy processor from an isolated power supply rather than the car's +12 volt DC and chassis ground. Make sure to also connect the turn-on lead to the isolated power supply. If the processor is now quiet , then it is highly probable that the component has inadequate isolation. Solutions include, changing components or permanently adding an external isolated power supply (Call Autosound 2000 at 209-465-3450 for info on isolated power supplies).

SUMMATION:

During the design stage of your vehicles, try to avoid using extra batteries and high output alternators. Extra batteries are nothing but loads as soon as the engine is started and high output alternators usually make more noise than stock alternators. Also, extra batteries installed in the trunk of a car will ALWAYS force extra ripple current to flow over the car.

Install Transient Storage as close to the power supply input of your amplifier as possible. The big caps will feed the switching power supplies of your amps and minimize the inductive losses in your power wiring. Plus, they will help your peak system response.

In problem cases, we highly recommend the use of twisted pair cable rather than coaxial cable for RCA leads. This practice will greatly minimize cable induced noise - especially in four channel amps!

Don't forget that your system is only as good as its worst component. Do NOT-use components with inadequate power supply isolation or you will be asking for problems.

The best electrical ground on a car is the CHASSIS of the car. Do NOT-run ground leads up to the case of the alternator or the negative battery post. Keep ALL-ground leads as short as possible.

With properly isolated components, it does NOT matter where the component is grounded. With inadequately isolated components, it matters! With poorly isolated components, different grounds can cause different noises.

The deck is the signal reference ground for the entire sound system. The deck usually has **THREE** connections to the car's chassis: The black ground lead, the base of the antenna, and the metal-to-metal bond between the case of the deck and the chassis of the car. With three grounds, there is usually NO cause to worry about the ground of a deck.

Amplifiers are usually designed with adequate power supply isolation. This means that it should not matter where a deck is grounded. (Decks are grounded three times and amps float. This is car audio!)

The more components installed on a signal path, the more chances for noise to enter a system. The more electrical accessories on a car, the more noise will be produced by the alternator.

This information was compiled from more than 20 years of working in car audio. If you would like more information on this topic, or any other technical aspect of car audio, please call 209-465-3450 and ask for a subscription to [Autosound 2000 Tech Briefs](#) - the monthly magazine for the technically inclined.

HIGH PERFORMANCE CAR AUDIO
AMPLIFIERS, SIGNAL PROCESSORS
AND LOUDSPEAKERS

MADE
IN THE
USA
BY ORION



©1998 Orion Industries, Incorporated
9235 S. McKerny Street , Tempe, Arizona 85284
Phone: 480.705.5600 Fax: 480.705.5788

One of the ADST family of companies.

Part # 8900-0113
Rev 5/99

Free Manuals Download Website

<http://myh66.com>

<http://usermanuals.us>

<http://www.somanuals.com>

<http://www.4manuals.cc>

<http://www.manual-lib.com>

<http://www.404manual.com>

<http://www.luxmanual.com>

<http://aubethermostatmanual.com>

Golf course search by state

<http://golfingnear.com>

Email search by domain

<http://emailbydomain.com>

Auto manuals search

<http://auto.somanuals.com>

TV manuals search

<http://tv.somanuals.com>