

# *Outdoor Gourmet*<sup>TM</sup>

## STAINLESS STEEL TABLETOP GAS GRILL

MODEL NO. M6G-124

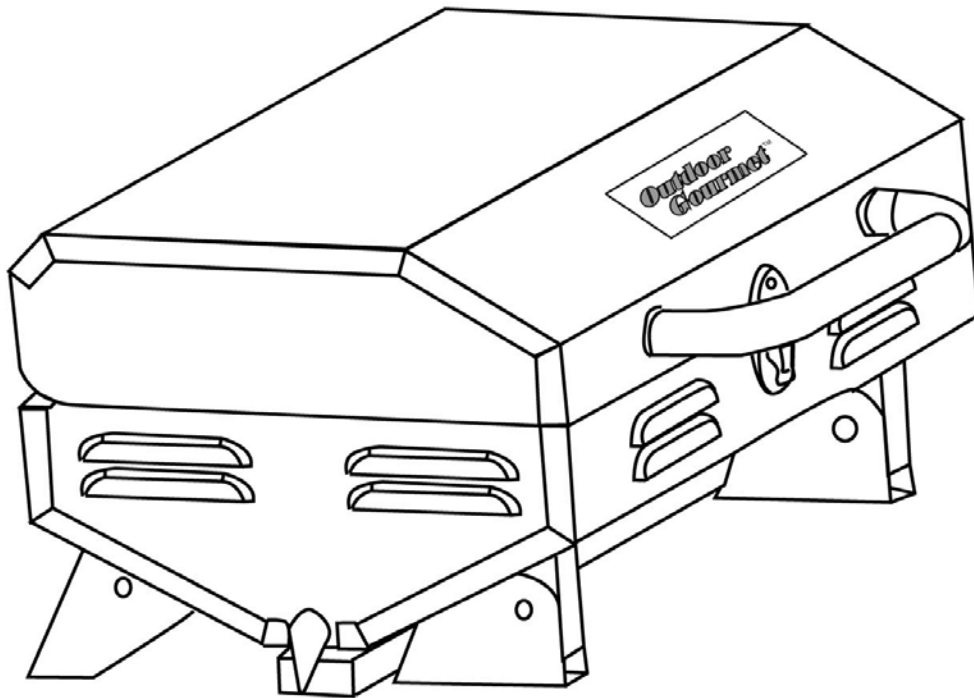

For Outdoor Use Only

Please read this owner's manual before using grill for the first time

This instruction manual contains important information necessary for the proper assembly and safe use of the grill. Please read and follow all warnings and instructions before assembling and using the grill.

Please verify that all parts are included with your grill before beginning assembly by checking the parts and hardware list on page 8. If all parts are not included, do not attempt to assemble the grill and call customer service at (888) 922-2336

Keep this owner's manual for future reference.

## General Safety Information



Indicates an imminently hazardous situation which, if not avoided could result in serious injury or death.



Indicates an imminently hazardous situation which, if not avoided, will result in death or serious injury.

 **WARNING** 

- Never operate this grill unattended. Keep children and pets away from grill at all times.
- Grill is for outdoor use only. Grill should be operated on a flat, level non-combustible surface. This grill is not intended to be installed in or on recreational vehicles or boats.
- Carefully follow instructions in this manual for proper assembly and leak testing. Do not use grill until leak test has been completed. If leak is detected at any time, turn OFF gas supply and DO NOT use until leak source is corrected.
- LP bottle should be in upright position. Ensure proper LP bottle position prior to lighting the grill.
- The use of alcohol, prescription or non-prescription drugs may impair your ability to properly assemble or safely operate the grill.
- Grill is not intended for commercial use.

 **DANGER** 

- Do not operate this grill within 10' (3m) of any other gas cylinder.
- Do not operate this grill within 25' (7.5m) of any flammable liquids.
- If a fire should occur, keep away from the grill and immediately call fire department. Do not attempt to extinguish an oil or grease fire with water.
- Do not install or use grill within 36" (10 ft. recommended) of combustible materials from back and sides of grill. Grill should not be operated in an enclosed area. (carport, garage, porch, patio). We recommend your grill should be situated at least 10 feet from buildings.
- Cooking area should be kept clear and free from combustible materials, gasoline, and other flammable vapors or liquids. Do not obstruct flow of combustion and ventilation air.
- Never try to light grill with lid closed! Buildup of gases is very dangerous and could cause an explosion.

Propane is highly volatile and even a 1lb cylinder contains enough gas to cause a serious fire or explosion. To reduce chances of liquid or gas leak or explosion, always follow these precautions when using propane.

## Safety Precautions

- Use only 1lb (16.4oz) propane cylinders.
- The LP gas cylinder used with the grill must be constructed and marked in accordance with the specifications for LP gas cylinder of the U.S. Department of Transportation (DOT) CFR 49, or the National Standard of Canada, CAN/CSA-B339, cylinders, Spheres and Tubes for the Transportation of Dangerous Goods.
- Do not attempt to refill any disposable propane cylinders.
- The cylinder must be installed, transported and stored in an upright position and should not be dropped or handled roughly.
- When the grill is to be stored indoors, the propane cylinder must be disconnected from the grill.
- Always attach or detach propane cylinder outdoor in a well-ventilated space.
- The cylinder should never be transported or stored where temperature can reach 124°F ( 51°C).

### If you smell gas:

1. Shut off gas to the grill.
2. Extinguish any open flame.
3. Open lid.
4. If odor continues, immediately call gas supplier or fire department.



### Natural Hazards-Insects and Spiders

A clogged tube can lead to a fire beneath the appliance. During shipment or storage, it is possible that small insects and spiders could find their way into the venturi tubes and make nests or webs. This could block the flow of gas through the venturi tube causing a smoky, yellowish flame, or prevent a burner from lighting. It could even cause the gas to burn outside the venturi tube, which could seriously damage your grill. If this occurs, turn off the gas flow and wait for the grill to cool. When the grill has cooled, remove the burner and clean out the venturi tube with a brush or pipe cleaner. Re-install the burner and be sure that the venturi tube is

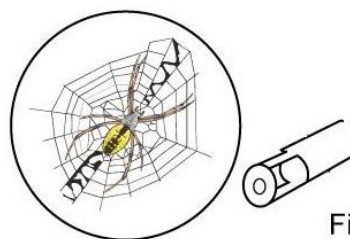

Fig.3

seated over the orifice located on the gas valves. Cleaning of the venturi tube should be conducted periodically.

## **BEFORE USING PROPANE CYLINDER**

1. Check cylinder and appliance seals. Never use with damaged or missing seals. Discard cylinder if dust or rust particular are in valve area.
2. Turn control valve OFF before attaching cylinder. Attach only outdoors, in a well ventilated area, away from flames, sparks or other sources of ignition.



BURNING PROPANE CAN MAKE CARBON MONOXIDE (CO), A COLORLESS, ODORLESS GAS THAT CAN CAUSE DEATH. NEVER USE YOUR GRILL IN AN ENCLOSED SPACE, SUCH AS A TENT OR CAMPER. NEVER USE YOUR GRILL AS A HEATER OR FOR ANY PURPOSE OTHER THAN GRILLING.

## **INSTALL CYLINDER**

1. Remove cap from end of propane cylinder. Cap should be kept on cylinder when not in use to prevent dirt and debris from entering regulator valve. Check end of cylinder attachment for dirt and debris. Clean out if necessary.
2. Insert threaded end of cylinder into regulator / control valve and hand-tighten. Do not use tools! Over-tightening can damage threads on regulator.
3. PERFORM A LEAK TEST. (Refer to page 5 for instructions on how to perform a leak test).

Please note:

This table top propane grill has been designed to work effectively without the use of lava rocks.

## **Leak Testing Regulator / Cylinder Connection – IMPORTANT!**

During leak testing, keep grill away from open flames or sparks and do not smoke. Grill must be leak tested outdoors in a well-ventilated area. Leak test must be repeated each time propane cylinder is replaced or after storage.

## HOW TO PERFORM LEAK TEST:

Use a clean paint brush and a 50/50 solution of mild soap and water. DO NOT USE HOUSEHOLD CLEANING AGENTS.

1. Be sure control valve on regulator is in OFF position.
2. Brush soapy solution onto connection between cylinder and regulator.

**If growing bubbles appear, there is a leak. Retighten connection and repeat steps 1 and 2.**

If you cannot stop a leak, remove cylinder from regulator and check for damaged threads, dirt and debris on regulator and cylinder.

**If threads are damaged on either regulator or cylinder, DO NOT use until replaced.** Also check to see if anything is obstructing the flow of gas at regulator and cylinder openings. Remove any obstruction that may be found and repeat leak test.



Before lighting – DO NOT use the grill if the odor of gas is present. The pressure regulator supplied with the unit must be used. Never substitute regulators for those supplied with the grill. If a replacement is necessary, contact the customer service number provided to obtain a proper replacement. Screw the propane bottle firmly into the regulator before operating the grill.



**LID MUST BE OPEN WHEN LIGHTING GRILL BURNERS**

## TO LIGHT GRILL BURNERS:

- Always keep your face and the body as far away from the grill as possible when lighting.
- Open the grill lid before lighting. Failure to open grill lid during the lighting procedures could result in a fire or explosion that could cause serious bodily injury, death, or property damage.

- Insert match or lighter through access hole next to the burner tube. Keep flame next to burner while pushing and turning the control knob to the “HI” position on regulator.
- If the burner does not light in 4 seconds, turn knob to “OFF” and wait 5 minutes before re-lighting, to allow any accumulated gas to dissipate. If the burner will not light after several attempts, then it can be match lit.
- Keep your face as far away from the grill as possible and pass a lit, long stem match through the grilling grid to the burner.
- Position the match near the burner ports. Push and turn the control knob to “HI”. If the burner does not light in 4 seconds turn the knob to “OFF”, wait 5 minutes and re-lighting.



OPERATE GRILL BETWEEN “HI” AND “LO” SETTING ONLY. OPERATING GRILL BELOW THE “LO” SETTING CAN RESULT IN A DANGEROUS FLAME-OUT AND BUILD-UP OF GAS. IF FLAME-OUT OCCURS, TURN KNOB TO “OFF” FOR FIVE MINUTES BEFORE RE-LIGHTING.

## **TO TURN OFF**

- After cooking, turn the grill off by rotating the control knob to OFF. Control knob should pop up in the OFF position. If control knob does not pop up, disconnect cylinder to turn the grill off and replace the regulator.
- Allow grill to cool completely before handling.

## **TO STORE**













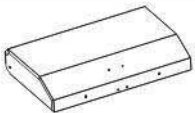
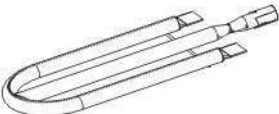

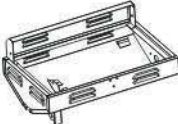

Make sure the grill has completely cooled. Remove propane cylinder and replace plastic cap on cylinder. Remove regulator from the grill to help keep dirt out of the propane cylinder probe. To protect the regulator during storage and transport, the regulator has been designed to be easily installed or removed from the grill. Before use, screw the regulator assembly into the plate on the side of the grill. Tighten by hand only – no tool required. When finished grilling, allow the grill to cool, then disconnect propane cylinder from the regulator, and unscrew regulator assembly from grill. Store regulator in a heavy plastic bag and place inside grill.

## Troubleshooting

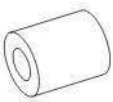
| <b>Problem</b>           | <b>Problem Cause/Solution</b>   |
|--------------------------|---|
| Burners will not light   | <ul style="list-style-type: none"><li>-Out of propane</li><li>-Regulator not fully tightened to cylinder.</li><li>-Inspect burner for obstructions.</li></ul> |
| Flame burns out on "LOW" | <ul style="list-style-type: none"><li>-Has grill been sufficiently preheated before turning to "LOW"?</li><li>-Too windy.</li></ul>                           |

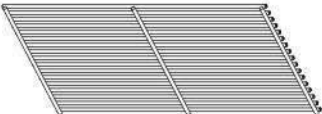

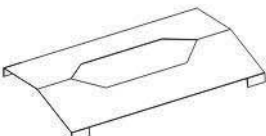
## PARTS LIST

| NO. | DESCRIPTION   | QTY | NO. | DESCRIPTION   | QTY |
|-----|---|-----|-----|---|-----|
| A   |    | 1   | J   |    | 1   |
| B   |    | 1   | K   |     | 1   |
| C   |    | 2   | L   |    | 1   |
| D   |    | 1   | M   |    | 1   |
| E   |   | 1   | N   |   | 1   |
| F   |  | 2   | O   |  | 1   |
| G   |  | 2   | P   |   | 1   |
| H   |  | 1   | Q   |  | 4   |
|     |   |     | R   | <b>M6X35</b>  | 4   |
|     |   |     | S   | <b>M6X10</b>  | 2   |
|     |   |     | T   | <b>M4X10</b>  | 4   |
|     |   |     | U   | <b>M4X20</b>  | 1   |
|     |   |     | V   | <b>M6 NUTS</b>  | 4   |
|     |   |     | W   | <b>M4 NUTS</b>  | 5   |
| I   |  | 1   | X   |  | 1   |

# PARTS DIAGRAM

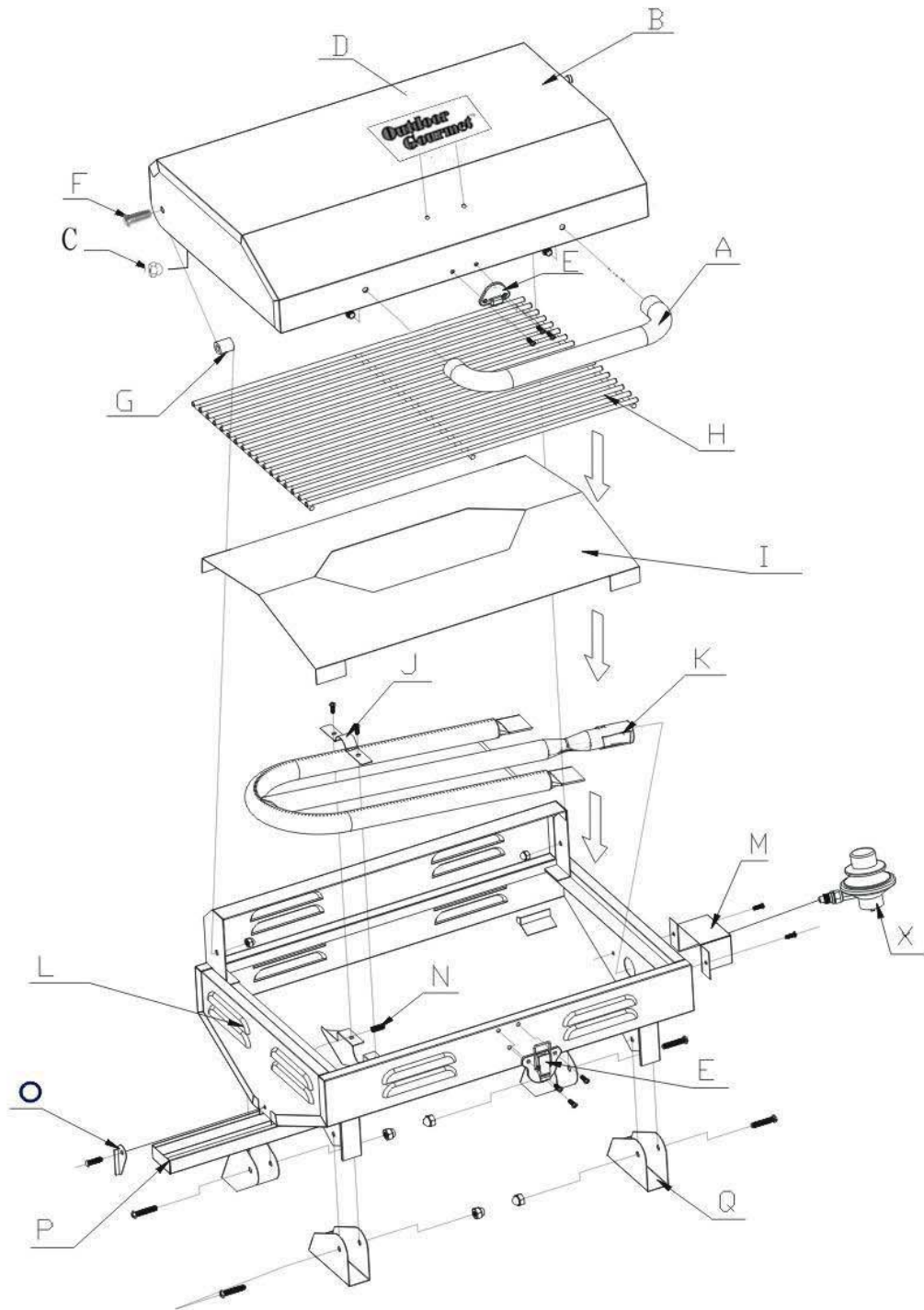

## **MAINTENANCE AND CLEANING:**

**CAUTION:** Always allow the grill to cool before cleaning or handling. Avoid exposing burner surface to water. Proper maintenance and cleaning will extend the life of your grill. Regulator cleaning will reduce accumulations of debris, grease and fats.

### **Cleaning:**

#### **Drip Pan:**

Remove drip pan from the grill and clean with mild soap and water. If pan is lined with foil, remove and replace foil, reinstall pan.

#### **Cooking Grid:**

Cooking grid can be cleaned with a grill cleaning brush while grids are still hot after each use.

#### **Stainless Steel Exterior Housing:**

Stainless steel requires very little maintenance. However, a good grade of stainless steel cleaner should be used for exterior cleaning.

#### **Maintenance:**

An occasional inspection of inlets and orifice openings is recommended. Any excess accumulation of debris on burner surface can be removed easily. Remove cooking grid and burner screen and vacuum burner surface every few months or as needed.

Made in China

For further information or replacement parts, Please call 888-922-2336

## Free Manuals Download Website

<http://myh66.com>

<http://usermanuals.us>

<http://www.somanuals.com>

<http://www.4manuals.cc>

<http://www.manual-lib.com>

<http://www.404manual.com>

<http://www.luxmanual.com>

<http://aubethermostatmanual.com>

Golf course search by state

<http://golfingnear.com>

Email search by domain

<http://emailbydomain.com>

Auto manuals search

<http://auto.somanuals.com>

TV manuals search

<http://tv.somanuals.com>