



Overland  
Storage

# REO 9000 with ProtectionPAC Software

*Disk-Based Backup-and-  
Recovery Appliance*

---

Setup Guide



ALWAYS THERE.

## OVERLAND STORAGE END USER LICENSE AGREEMENT (“EULA”)

IMPORTANT NOTICE - PLEASE READ THIS END USER SOFTWARE LICENSE AGREEMENT (“EULA”) CAREFULLY BEFORE USING THE SOFTWARE CONTAINED IN THIS EQUIPMENT OR USING THIS EQUIPMENT IN ANY MANNER.

BY USING THE EQUIPMENT THAT CONTAINS THIS SOFTWARE, YOU ARE CONSENTING TO BE BOUND BY THIS AGREEMENT. IF YOU DO NOT AGREE TO ALL OF THE TERMS OF THIS END USER AGREEMENT, PROMPTLY RETURN AND DO NOT USE THE EQUIPMENT AND THE SOFTWARE.

**1. Single User License.** Subject to the terms and conditions of this EULA, Overland Storage, Inc. (“Overland”) grants to you (“Customer”) a non-exclusive, non-transferable license to use (a) Overland software which provides the basic operating environment for Overland equipment and whether pre-installed on, embedded in or provided with Overland equipment, and (b) the specific Overland program modules or features which have been enabled by security keys supplied by Overland and for which Customer had paid any applicable license fees (collectively, the “Software”), both of the foregoing in object code form only: (i) solely as pre-installed, embedded in or provided with Overland equipment owned or leased by Customer; and (ii) for key-enabled Software corresponding to the security key(s) supplied by Overland and for the license fees paid by Customer.

**2. Limitations.** Except as otherwise expressly provided under this EULA, Customer will have no right, and Customer will not:

(i) make error corrections to or otherwise modify or adapt the Software nor create derivative works based upon the Software, or to permit third parties to do the same;

(ii) copy, in whole or in part, de compile, translate, reverse engineer, disassemble or otherwise reduce the Software to human-readable form; or

(iii) remove the Software from the equipment in which it is embedded.

**3. Upgrades and Additional Copies.** For purposes of this EULA, “Software” will also include (and the terms and conditions of this EULA will apply to) any upgrades, updates, bug fixes or modified versions (collectively, “Upgrades”) or backup copies of the Software licensed or provided to Customer by Overland or an authorized distributor for which Customer had paid the applicable license fees and holds the corresponding software keys. Notwithstanding the foregoing, Overland will have no obligation to provide any Upgrades under this EULA. If Upgrades are provided, (i) Customer has no license or right to use any such additional copies or Upgrades unless Customer, at the time of acquiring such copy or Upgrade, already holds a valid license and the corresponding security keys to the original Software; and (ii) use of the Upgrades is limited to Overland equipment for which Customer is the original End-User purchase or lessee. 4. U.S. Government Restriction Rights. The Software was developed at private expense and is provided with “RESTRICTED RIGHTS” as set forth in this License Agreement. Use, duplication or disclosure by the United States government is subject to restrictions as set forth in FAR 52.227-14 and DFARS 252.227-7013 et seq., or its successors. The use of this Software constitutes acknowledgement of Company's and its licensors' rights in the Software.

**4. Notices of Proprietary Rights.** Customer will maintain and reproduce all trademark, copyright, patent, and notices of other proprietary rights on all copies, in any form, of the Software in the same form and manner that such trademark, copyright, patent, and notices of other rights are included on the Software. Except as expressly authorized in this EULA, Customer will not make any copies or duplicates of any Software without the prior written permission of Overland.

**5. Proprietary Rights.** The Software is and will remain the sole and exclusive property of Overland. Software is licensed, not sold, by Overland hereunder. Any references to terms in connection with the foregoing, such as “sale”, “purchase” or “sell” will be interpreted as licensed rights granted on a non-exclusive basis hereunder and as otherwise provided in this EULA. Overland's rights under this Section will include, but not be limited to: (i) all copies of the Software, in whole and in part; and (ii) all intellectual property rights in the Software.

**6. Confidential Information.** Customer will not disclose or, except as expressly permitted in this EULA, use any Software or other technical information disclosed to Customer by Overland (“Confidential Information”). Customer will take all reasonable measures to maintain the confidentiality of all Confidential Information in Customer's possession or control, which will in no event be less than the measures Customer uses to maintain the confidentiality of Customer's own information of equal importance. Confidential Information will not include information that: (i) is in or enters the public domain without breach of this EULA; (ii) Customer receives from a third party without restriction on disclosure and without breach of a nondisclosure obligation; or (iii) Customer develops independently, which Customer can prove with written evidence.

The Confidential Information is a trade secret of Overland, the disclosure of which would cause substantial harm to Overland that could not be remedied by the payment of damages alone. Accordingly, Overland will be entitled to preliminary and permanent injunctive relief and other equitable relief for any breach of this Section.

**7. Limited Software Warranty.** Overland warrants that the Software will substantially conform to its published specifications for a period of 90 days from the later of receipt of the equipment containing the Software or receipt of access to the Software. This limited warranty extends only to Customer as the original licensee. Provided that (a) Customer has notified Overland of such substantial non-conformance during the applicable warranty period, and (b) Overland has confirmed such Software to be substantially non-conforming, as Customer's sole and exclusive remedy and Overland' and its suppliers' entire liability under this limited warranty, Overland will, at its option, repair, replace, or refund the Software pursuant to Overland's then-current warranty policy.

Except as expressly provided in this EULA, the Software is provided “AS IS” without warranty of any kind. Overland does not warrant that the Software is error free or that Customer will be able to operate the Software without problems or interruptions. Overland reserves the right to charge additional fees for repairs or replacements performed outside of the 90-day limited warranty period.

This warranty does not apply if the Software or the Overland equipment in which the Software is embedded (i) is licensed for beta, evaluation, testing or demonstration purposes for which Overland does not receive a license fee, (ii) has been altered, except by Overland, (iii) has not been installed, operated, repaired, or maintained in accordance with instructions supplied by Overland, (iv) has been subjected to abnormal physical or electrical stress or to misuse, negligence, or accident, or (v) is used in ultra-hazardous activities.

**8. Disclaimer.** EXCEPT AS SPECIFIED IN THIS EULA, ALL EXPRESS OR IMPLIED CONDITIONS, REPRESENTATIONS, AND WARRANTIES INCLUDING, WITHOUT LIMITATION, ANY IMPLIED WARRANTY OR CONDITION OF MERCHANTABILITY, FITNESS FOR A PARTICULAR PURPOSE, NON-INFRINGEMENT, SATISFACTORY QUALITY OR ARISING FROM A COURSE OF DEALING, USAGE, OR TRADE PRACTICE, ARE HEREBY EXCLUDED TO THE EXTENT ALLOWED BY APPLICABLE LAW. IN NO EVENT WILL OVERLAND OR ITS SUPPLIERS BE LIABLE FOR ANY LOST REVENUE, PROFIT, OR DATA, OR FOR SPECIAL, INDIRECT, CONSEQUENTIAL, INCIDENTAL, OR PUNITIVE DAMAGES HOWEVER CAUSED AND REGARDLESS OF THE THEORY OF LIABILITY ARISING OUT OF THE USE OF OR INABILITY TO USE THE SOFTWARE EVEN IF OVERLAND OR ITS SUPPLIERS HAVE BEEN ADVISED OF THE POSSIBILITY OF SUCH DAMAGES. IN NO EVENT WILL OVERLAND'S TOTAL LIABILITY TO CUSTOMER, WHETHER IN CONTRACT, TORT (INCLUDING NEGLIGENCE), OR OTHERWISE, EXCEED THE PRICE PAID BY CUSTOMER. THE FOREGOING LIMITATIONS WILL APPLY EVEN IF THE ABOVE-STATED WARRANTY FAILS OF ITS ESSENTIAL PURPOSE.

Each party recognizes and agrees that the warranty disclaimers and liability and remedy limitations in this EULA are material bargained for bases of this EULA and that they have been taken into account and reflected in determining the consideration to be given by each party under this EULA and in the decision by each party to enter into this EULA.

**9. Term and Termination.** This EULA is effective until terminated. Customer's license rights under this EULA will terminate immediately without notice from Overland if Customer fails to comply with any provision of this EULA. Upon termination, Customer must destroy all copies of Software and the corresponding security keys in its possession or control.

**10. Compliance With Law.** Each party will comply with all applicable laws, rules and regulations in connection with its activities under this EULA. Without limiting the foregoing, the Software, including technical data, is subject to United States export control laws, including the United States Export Administration Act and its associated regulations, and may be subject to export or import regulations in other countries. Customer will comply strictly with all such regulations and acknowledges that Customer has the responsibility to obtain licenses to export, re-export, or import the Software.

**11. Restricted Rights.** The Software will be classified as "commercial computer software" as defined in the applicable provisions of the Federal Acquisition Regulation (the "FAR") and supplements thereto, including the Department of Defense (DoD) FAR Supplement (the "DFARS"). The parties acknowledge that the Software was developed entirely at private expense and that no part of the Software was first produced in the performance of a Government contract. If the Software is supplied for use by DoD, the Software is delivered subject to the terms of this EULA and either (i) in accordance with DFARS 227.702-1(a) and 227.7202-3(a), or (ii) with restricted rights in accordance with DFARS 252.227-7013(c)(1)(ii) (OCT 1988), as applicable. If the Software is supplied for use by a Federal agency other than DoD, the Software is restricted computer software delivered subject to the terms of this EULA and (i) FAR 12.212(a); (ii) FAR 52.227-19; or (iii) FAR 52.227-14 (ALT III), as applicable.

**12. Third Party Software.** Third party suppliers of materials integrated with the Overland equipment disclaim all implied warranties, including the implied warranties of merchantability and fitness for a particular purpose. The collective liabilities of the seller/licensor and its third party suppliers are subject to the limitation of liabilities described in this agreement. The third party supplier is an intended beneficiary of this limitation." Third party suppliers disclaim all liability for consequential or other indirect damages or for loss of or damage to data or records.

**13. General.** This EULA will bind and inure to the benefit of each party's successors and assigns, provided that Customer may not assign or transfer this EULA, in whole or in part, without Overland' written consent.

This EULA will be governed by and construed in accordance with the laws of the State of California, United States of America, as if performed wholly within the state and without giving effect to the principles of conflict of law.

No failure of either party to exercise or enforce any of its rights under this EULA will act as a waiver of such rights.

Any waivers or amendments will be effective only if made in writing by non-preprinted agreements clearly understood by both parties to be an amendment or waiver and signed by a representative of the respective parties authorized to bind the parties.

If any portion hereof is found to be void or unenforceable, the remaining provisions of this EULA will remain in full force and effect.

This EULA is the complete and exclusive agreement between the parties with respect to the subject matter hereof, superseding and replacing any and all prior agreements, communications, and understandings (both written and oral) regarding such subject matter.

Any notice, report, approval or consent required or permitted hereunder will be in writing and will be deemed to have been duly given if delivered personally or mailed by first-class, registered or certified US mail, postage prepaid to the respective addresses of the parties. The prevailing party in any action to enforce this EULA will be entitled to recover costs and expenses including, without limitation, reasonable attorneys' fees.

A material breach of this EULA adversely affecting Overland's proprietary rights in the Software would cause irreparable injury to Overland for which monetary damages would not be an adequate remedy and that Overland will be entitled to equitable relief in addition to any remedies it may have hereunder or at law.

**©2004 Overland Storage, Inc. All rights reserved.**

Overland® and Overland Storage® are registered trademarks of Overland Storage, Inc. Simply iSCSI, REO SERIES™, REO 100™, REO 1000™, REO 4000™, REO 9000™, ProtectionPAC™, Multi-SitePAC™, AutomationPAC™, CompliancePAC™, BackPAC™, REO SoftKey™, and D2D2T™ are trademarks of Overland Storage, Inc.

All other brand names or trademarks are the property of their respective owners.

The names of companies and individuals used in examples are fictitious and intended to illustrate the use of the software. Any resemblance to actual companies or individuals, whether past or present, is coincidental.

**PROPRIETARY NOTICE**

All information contained in or disclosed by this document is considered proprietary by Overland Storage. By accepting this material the recipient agrees that this material and the information contained therein are held in confidence and in trust and will not be used, reproduced in whole or in part, nor its contents revealed to others, except to meet the purpose for which it was delivered. It is understood that no right is conveyed to reproduce or have reproduced any item herein disclosed without express permission from Overland Storage.

Overland Storage provides this manual as is, without warranty of any kind, either expressed or implied, including, but not limited to, the implied warranties of merchantability and fitness for a particular purpose. Overland Storage may make improvements or changes in the product(s) or programs described in this manual at any time. These changes will be incorporated in new editions of this publication.

Overland Storage assumes no responsibility for the accuracy, completeness, sufficiency, or usefulness of this manual, nor for any problem that might arise from the use of the information in this manual.

Overland Storage, Inc.  
4820 Overland Avenue  
San Diego, CA 92123  
U.S.A.

Tel: +1.858.571.5555  
Tel: 1.800.729.8725 (toll free U.S.)  
Fax: +1.858.571.0982 (general)  
Fax: +1.858.571.3664 (sales)  
[www.overlandstorage.com](http://www.overlandstorage.com)



ALWAYS THERE.



	<b>Preface</b> . . . . .	<b>9</b>
<b>Chapter 1</b>	<b>Reviewing REO 9000 Concepts and Requirements</b> . . . . .	<b>11</b>
	Important Concepts to Understand . . . . .	11
	Internet SCSI (iSCSI) Protocol . . . . .	11
	Fibre Channel (FC) . . . . .	12
	Disk-to-Disk-to-Tape (D2D2T) Backup Capabilities . . . . .	13
	Redundant Array of Independent Disks (RAID). . . . .	15
	Tape Emulation . . . . .	16
	Logical Volume Management (LVM). . . . .	16
	Reviewing Pre-Installation Requirements . . . . .	16
	Network . . . . .	17
	iSCSI Initiators . . . . .	17
	Setting the SCSI Time-Out Value in Windows Environments . . . . .	18
<b>Chapter 2</b>	<b>Setting Up the REO 9000</b> . . . . .	<b>19</b>
	Preparing the REO Appliance . . . . .	19
	Positioning the REO Appliance in a Rack . . . . .	21
	Installing the Disk Carriers and Disk Drives . . . . .	25
	Connecting the REO Appliance to the Management LAN. . . . .	26
	Connecting the REO Appliance to the Network . . . . .	27
	Connecting External Devices to the REO Appliance . . . . .	28
	Attaching the Power Cords . . . . .	28
<b>Chapter 3</b>	<b>Using the REO SoftKey to Start the REO 9000</b> . . . . .	<b>31</b>
	Understanding What the REO SoftKey Is. . . . .	31
	Backing Up Your REO SoftKey (Pre-Configuration) . . . . .	32
	Editing the Configuration File (for a non-DHCP or UNIX Management System) . . . . .	33
	Connecting the REO SoftKey to the REO Appliance . . . . .	36
<b>Chapter 4</b>	<b>Configuring the Management System</b> . . . . .	<b>39</b>
	Mapping a Network Drive to the REO Appliance (Windows Only). . . . .	39
	Tracking Configuration Information . . . . .	41
	Verifying that the Gateway Address and Management Port are Correctly Configured . . . . .	52
	Configuring the GbE Data Ports . . . . .	55
	Entering the Fibre Channel Information . . . . .	56
	Entering the System Information . . . . .	57
	Configuring Logon Information . . . . .	58
	Configuring E-mail Alerts . . . . .	58

	Setting the Time and Date Information . . . . .	60
<b>Chapter 5</b>	<b>Configuring the Systems Involved in the Backup Process . . . . .</b>	<b>61</b>
	Mapping a Network Drive to the REO Appliance (Windows Only). . . . .	61
	Establishing Communication . . . . .	61
<b>Chapter 6</b>	<b>Changing the Volume Setup or Creating Logical Volumes . . . . .</b>	<b>63</b>
	Using the Default Volume Setup . . . . .	63
	Changing the Volume Configuration. . . . .	63
	Selecting JBOD . . . . .	64
	Selecting a RAID Configuration . . . . .	65
	Creating Logical Volumes . . . . .	71
<b>Chapter 7</b>	<b>Configuring REO Devices as Disk or Tape Devices . . . . .</b>	<b>73</b>
	Using Devices as Disk Devices . . . . .	73
	Creating Tape Devices. . . . .	73
	Changing a Device from Disk to Tape (Standard) . . . . .	74
	Changing a Device from Disk to Dynamic Tape . . . . .	77
<b>Chapter 8</b>	<b>Configuring External (SCSI) Devices . . . . .</b>	<b>81</b>
	Detecting External Devices . . . . .	81
	Changing the iSCSI Target Name . . . . .	84
<b>Chapter 9</b>	<b>Associating Targets (Devices) and Initiators . . . . .</b>	<b>87</b>
	Understanding How Initiators and Targets (Devices) are Connected . . . . .	87
	Reviewing iSCSI Naming Conventions . . . . .	87
	Reviewing How Targets (REO Devices) and Initiators are Associated . . . . .	89
	Configuring Targets (REO Devices and External Devices) and Initiators . . . . .	91
	Configuring REO Devices (Targets) and Initiators . . . . .	92
	Configuring the iSCSI Initiator with Target (REO Device) and Initiator Assignments. . . . .	95
	Configuring External Devices (Targets) and Initiators . . . . .	96
	Configuring the iSCSI Initiator with Target (External Device) and Initiator Assignments . . . . .	97
	Backing Up Your REO SoftKey (Post-Configuration) . . . . .	97
<b>Chapter 10</b>	<b>Working with the REO 9000 . . . . .</b>	<b>99</b>
	Logging On from Any System with Network Access . . . . .	99
	Understanding the Summary Pages . . . . .	100
	Reviewing the REO Device Summary Page . . . . .	101
	Reviewing the Initiator Summary Page . . . . .	102
	Reviewing the External Device Summary . . . . .	103
	Reviewing the External Initiator Summary Page . . . . .	103
	Reviewing How the Disk Drives are Numbered . . . . .	104
	Understanding What the LEDs Represent . . . . .	104
	Powering Down the REO Appliance . . . . .	105
<b>Chapter 11</b>	<b>Expanding Storage Capacity (Scalability) . . . . .</b>	<b>107</b>
	Setting Up Additional REO Appliances in an iSCSI Configuration . . . . .	107
	Setting Up Additional REO Appliances in an FC Topology . . . . .	108
	Attaching Each REO Appliance Separately . . . . .	110
	Expanding the Capacity of a REO 9000 by Adding Disk Drives . . . . .	112

<b>Appendix A</b>	<b>Sharing Access to a REO 9000 Between Multiple Systems</b>	<b>115</b>
	Configuring Devices as Shared Devices.	116
	Accessing a Shared Device.	117
<b>Appendix B</b>	<b>Basic Troubleshooting</b>	<b>119</b>
	Using the SoftKey Reset Option	119
	Sending the Log Files to Technical Support	120
	Unable to Access the REO Appliance	120
	REO Appliance Does Not Start	121
	Unable to Log On to the Console	122
	Internet Explorer Does Not Redirect from IP Address on Windows Server 2003	123
	Browser Does Not Reflect Changes Made from Another System or Browser Window	124
	Unable to Connect to the Disks via Windows Explorer.	125
	Perpetual Loop of Audio Alerts	127
	Disabling the Audio Alarm	127
	Systems Restart When I Map a Disk Drive	127
	I Forgot the New Password or Logon Name	128
	Lost or Damaged REO SoftKey or Files Accidentally Deleted from the Key	129
	Determining Whether a Disk Drive is Faulty or There is a Problem with the REO Appliance	129
	Forcing an Add (JBOD)	129
	Re-Creating a RAID 0 Volume.	132
	Rebuilding a Volume (RAID 5 Without Hot Spare)	136
	Re-Creating a Hot Spare (RAID 5 With Hot Spares)	141
	Purchasing a Spare Disk Drive	144
	Does the Appliance Automatically Start After a Power Outage?	145
<b>Appendix C</b>	<b>Updating the Appliance</b>	<b>147</b>
	Determining the Version of the Product.	147
	Checking For and Downloading Updates.	148
	Installing an Update	151
	Updating the Firmware on the FC Controller.	153
<b>Appendix D</b>	<b>Specifications</b>	<b>155</b>
	Electromagnetic Emission.	156
	Notice.	156
	Industry Canada	156
	Industrie Canada	156
	FCC Notice	156
	Japan Voluntary Control Council for Interference (VCCI)	157
	Taiwan BSMI Class A Warning	157
	Declaration of Conformity	158
<b>Appendix E</b>	<b>Customer Support</b>	<b>159</b>
	Registering Your Product	159
	Locating Additional Information for Your Product	160
	<b>Glossary and Acronym List.</b>	<b>163</b>
	<b>Index</b>	<b>167</b>







# Preface

---

The Overland Storage REO 9000 Disk-Based Backup-and-Recovery Appliance takes the lag time, expense, and burden out of backing up critical data and works seamlessly within current storage environments. The REO Appliance performs faster than traditional disk-based storage methods and serves as a shared network resource by utilizing high-capacity disks, high-speed Ethernet and Internet SCSI (iSCSI) connectivity, and unique software intelligence capability from Overland Storage.

The REO Appliance comes with a standard software package called the ProtectionPAC. The ProtectionPAC software contains all the basic features that you need to configure your REO Appliance to work within your network environment.

This document includes information that helps you set up the REO Appliance, including system requirements, questions that you need to answer before installing the product, and installation procedures.

---

**Important:** If you purchased multiple units, set up (attach and configure) one unit at a time. The target names must be unique within a network; that is, if you are using multiple appliances, you must change the default target names.

Also, be aware that the keys are *not* interchangeable and Overland strongly recommends that you make a backup copy of the files on the keys before *and* after you configure them.

---





# 1 | Reviewing REO 9000 Concepts and Requirements

## CHAPTER

The main steps involved in preparing to set up the REO Appliance include:

- Step 1** Understanding the concepts of iSCSI, Fibre Channel (FC), disk-to-disk-to-tape (D2D2T) backup, redundant array of independent disks (RAID), tape emulation, logical volume management (LVM), and how the REO Appliance fits into the picture.
- Step 2** Reviewing the requirements that your servers and network must meet to ensure successful installation and operation of the REO Appliance.

## Important Concepts to Understand

To understand the configuration of the backup network and how it fits into the local-area network (LAN) or Fibre Channel (FC) storage-area network (SAN), review the following sections.

### Internet SCSI (iSCSI) Protocol

Internet SCSI (iSCSI) is a standard protocol for universal access to shared storage devices over standard, Ethernet-based transmission control protocol/Internet protocol (TCP/IP) networks. The connection-oriented protocol transports SCSI commands, data, and status across an IP network. For more information, see *Glossary and Acronym List* on page 163.

### iSCSI Architecture

The iSCSI architecture is based on a client-server model. The client is a host system that issues requests to read or write data. iSCSI refers to a client as an *initiator*. The server is a resource that receives and executes client requests. iSCSI refers to a server as a *target*.

File servers, which store the programs and data files shared by users, normally play the role of server. With the REO Appliance, the application and backup servers within your network act as clients or initiators and the REO Appliance acts as a server or target. The initiators can either be software drivers or iSCSI host bus adapters (HBAs) on the server that is being backed up.

## Fibre Channel (FC)

Instead of, or in addition to, using iSCSI and the TCP/IP protocol to transmit information over a network, you also have the option of using a SAN that makes use of the FC and Small Computer System Interface (SCSI) protocols. The FC protocol uses two additional protocols to communicate at the hardware level: Fibre Channel Arbitrated Loop (FC-AL), which communicates with hubs, and Fibre Channel Switched (FC-SW), which communicates with switches. The SCSI protocol provides the communication link at the higher level, between the hardware and the software.

You can use all three basic FC SAN topologies with the REO Appliance:

- **Point-to-point.** This topology provides a direct connection between two N\_Ports.
- **Arbitrated loop.** In an arbitrated loop, NL\_Ports and FL\_Ports are daisy-chained with hubs, which means that only one device can send data at a time.
- **Switched fabric.** Switched fabric consists of one or more switches that are interconnected, and multiple nodes connected to the switches.

The REO Appliance supports the following types of ports for FC:

Port Type	Represents	Associated Topology
N_Port	Node Port	Connects point-to-point or to F_Port
NL_Port	Node Loop Port	N_Ports that can connect to an arbitrated loop

FC uses strict naming conventions to support unique, 64-bit names for the worldwide node name (WWNN) and the worldwide port name (WWPN). These names are pre-assigned by the manufacturers of the different hardware components used in an FC.

## Disk-to-Disk-to-Tape (D2D2T) Backup Capabilities

The REO Appliance is a storage resource used by a single backup server or shared by multiple backup servers using an Ethernet or FC network. By using standard backup software, you can copy backup data that resides on the REO Appliance to tape for long-term data retention.

The following illustration shows application servers sending backup data over a 10/100 or Gigabit Ethernet (GbE) LAN to backup servers sharing REO Appliance D2D storage over GbE or FC.

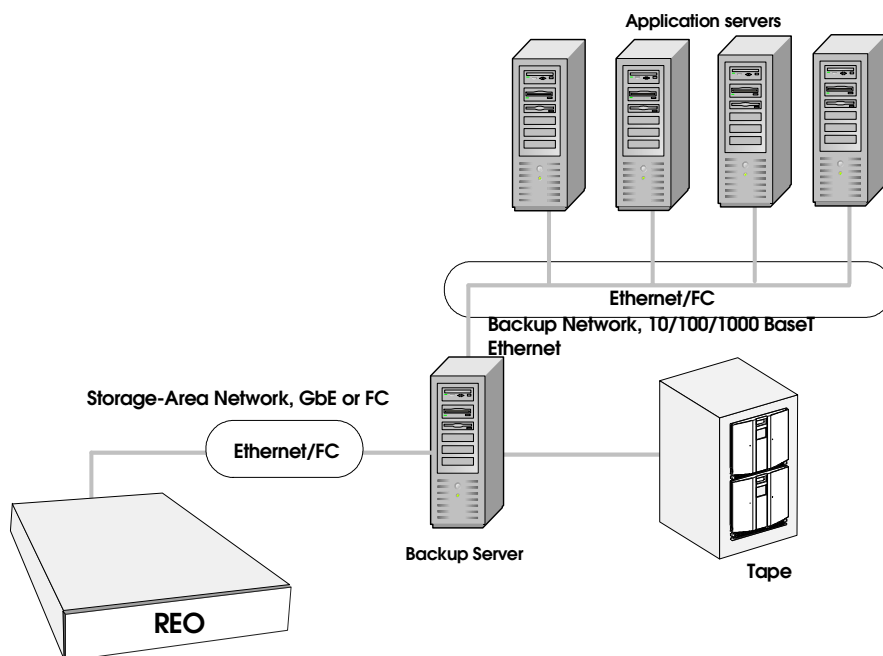

In addition to being part of the LAN, the backup servers, and the REO Appliance are part of the GbE backup SAN.

The following diagrams show two different ways of configuring a REO Appliance with multiple backup servers.

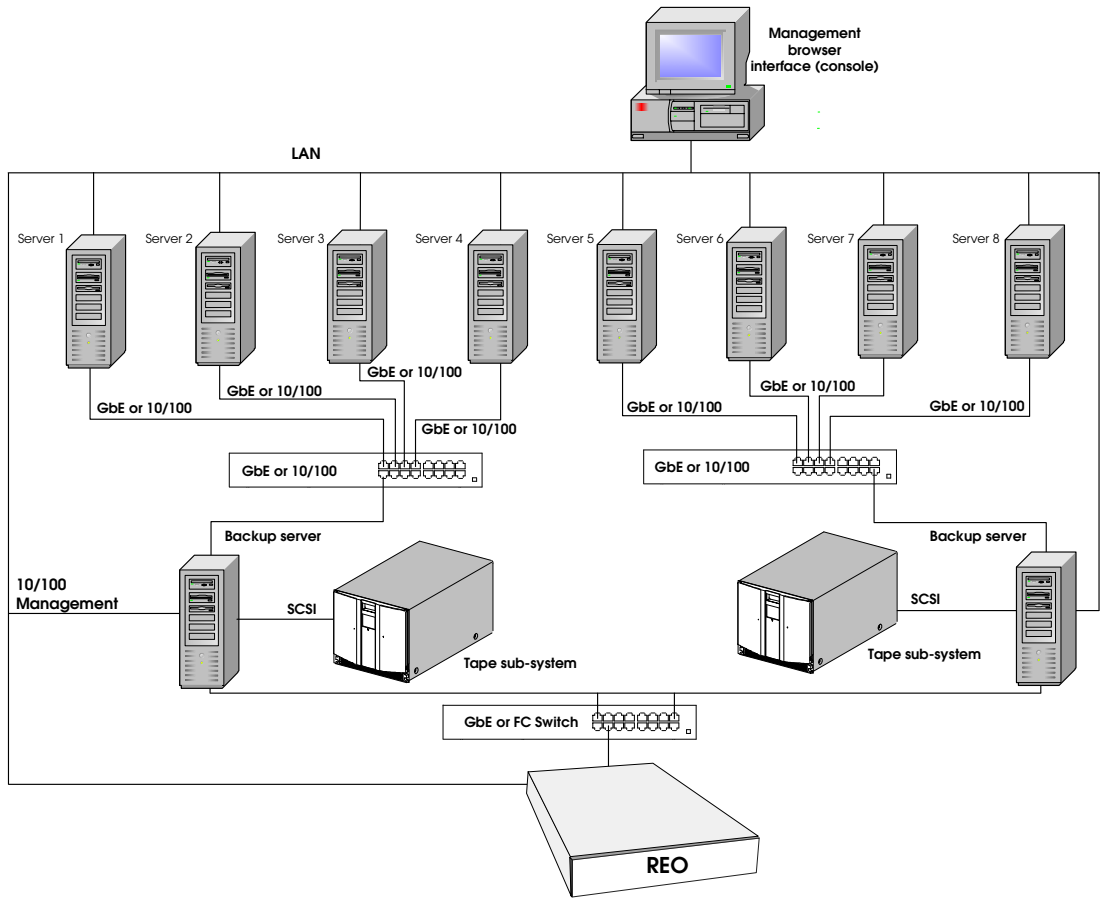

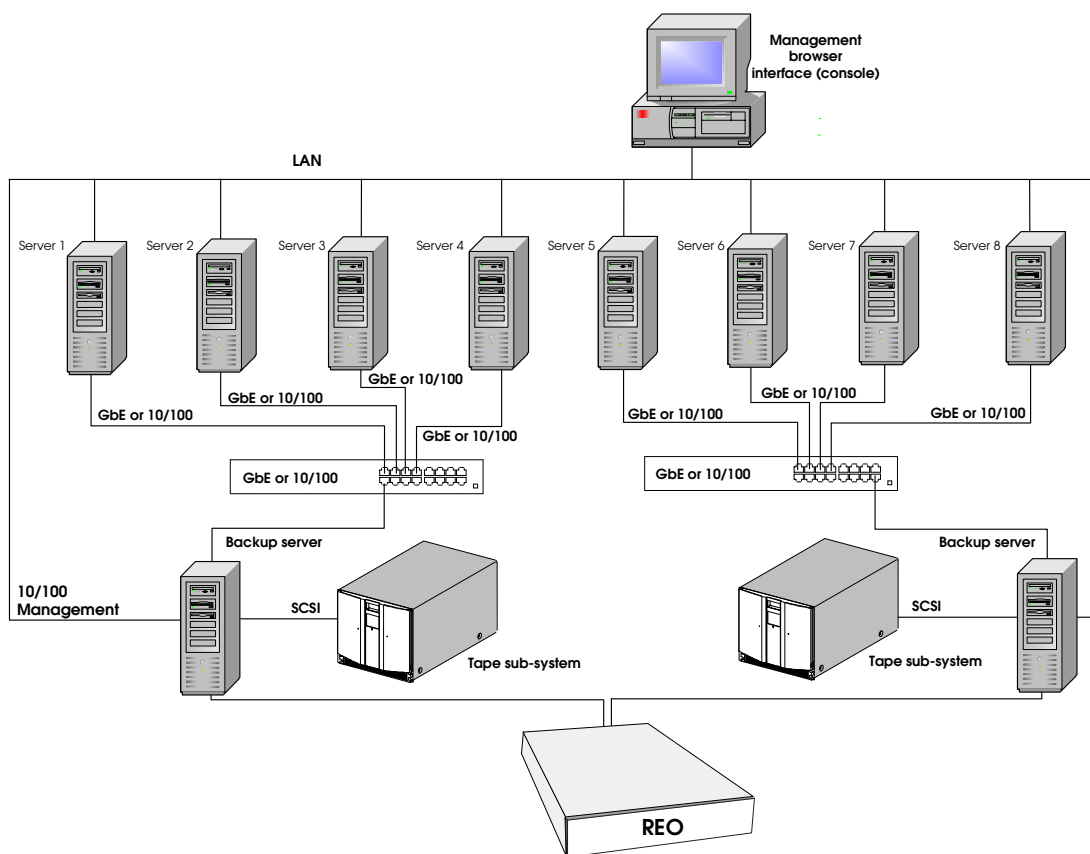

## Redundant Array of Independent Disks (RAID)

RAID provides convenient, low-cost, reliable storage by saving data on more than one disk drive simultaneously. If one disk drive in a RAID 5 configuration becomes unavailable, the others continue to work in a degraded state, thus avoiding downtime for users.

**Note:** Because RAID 5 is designed for data protection, you might see performance degradation when compared to JBOD operations.

RAID allows you to group the individual disk drives on the REO Appliance into logical disk drives of different sizes. You can configure your REO Appliance to create two physical RAID volumes by selecting either of the following RAID options:

- **RAID 0.** This configuration uses striping, which provides enhanced performance and volume-level capacity. It divides the data into blocks and writes each block to a separate disk drive, which improves performance by dispersing the input and output load. RAID 0 does not provide data redundancy.
- **RAID 5.** This configuration uses striping and distributed parity, which provides a balance between performance and availability. In addition to dividing the data into blocks as described for RAID 0, the parity information is also striped across the disks. If one of the disk drives fails, you can use the parity information to rebuild the lost data.

In addition to using either of the preceding RAID configurations, you can also take advantage of logical volume management (LVM) and create logical volumes from the data pool.

If you use a RAID 5 configuration, you can also set aside a disk drive for each physical host (controller); that is, you can create a hot spare. These disk drives remain in standby mode, and you can use them immediately if another disk fails.

## Tape Emulation

The ProtectionPAC software includes two tape emulation features, which you can use to create virtual linear tape-open (LTO-2) tape devices that provide 2-to-1 compression ratios with typical data sets (actual performance might vary with application). When you use tape emulation, the disk drives on the REO Appliance appear to your backup software as LTO-2 tape drives, which simplifies the setup process while simultaneously providing data compression and the attributes of backing up data to disk.

Depending on the configuration that you use, you get a different number of virtual LTO-2 devices. In the just-a-bunch-of-disks (JBOD) configuration, you can have up to 24. If you use RAID 0 or 5 without logical volumes, you can have four. If you use logical volumes with RAID 0 or 5, you can create up to 64 virtual LTO-2 devices.

If you decide to use tape emulation, you also have the option of using fixed-length (Tape) or dynamic-length (Dynamic Tape) devices. To take advantage of the Dynamic Tape option, you must use logical volumes, which is described in the next section. Using Dynamic Tape lets you create devices that adjust to the size of individual backup jobs.

## Logical Volume Management (LVM)

With LVM, you can combine the two physical RAID volumes into multiple logical volumes (partitions) of different sizes and assign logical unit numbers (LUNs) to represent the different volumes, or REO devices. This feature lets you set up and assign devices to different systems according to your needs and the configuration and type of storage network that you use.

Using this feature in the ProtectionPAC software, you can create up to 64 LUNs, and you can reassign space allocation for disk or standard (not dynamic) virtual tape devices, in 1 gigabyte (GB) increments, on the fly.

## Reviewing Pre-Installation Requirements

Before attempting to operate the REO Appliance with your backup servers, verify that your network meets the minimum requirements specified in the following sections.

---

**Important:** If you purchased multiple units, set up (attach and configure) one unit at a time. The target names must be unique within a network; that is, if you are using multiple appliances, you must change the default target names.

Also, be aware that the keys are *not* interchangeable and Overland strongly recommends that you make a backup copy of the files on the keys before *and* after you configure them.

---



## Network

For best results, Overland Storage strongly recommends that you use a dedicated GbE network to share the storage resources on the REO Appliance among multiple backup servers.

To ensure optimum performance, always use the appropriate patch cables to connect the REO Appliance to the backup-server storage network. To select the appropriate cables, use the following guidelines:

- If you intend to use GbE, you must use Category 5E (or better) cables for GbE connections. You can use either straight-through or cross-over cables.
- If you intend to connect the REO Appliance to a 100 BaseT network, use CAT 5 (or better) shielded (screened) or unshielded 100-ohm twisted-pair RJ-45 network cables. Also:
  - If you intend to connect the Management Port, which is a 10/100 port, to an application or backup server via a switch, you must use a straight-through cable.
  - If you intend to connect the Management Port directly to your application or backup server (without a switch), you must use a cross-over cable.
- The maximum length of cable for any Ethernet-based network connection is 328 feet (100 meters).

**Note:** For smaller environments, you can attach the REO Appliance directly to a single application or backup server by using standard Category 5E cables without the use of a switch.

## iSCSI Initiators

iSCSI initiators are required to communicate with the iSCSI targets (REO Devices) on the REO Appliance. Each backup server that will interface with the REO Appliance must be equipped with a software- or hardware-based initiator. The REO Appliance supports any computing platform with an available iSCSI initiator, either in software or using an iSCSI HBA (it must be iSCSI draft 20/version 1.0).

## Setting the SCSI Time-Out Value in Windows Environments

If you intend to use your REO Appliance in a Windows environment, be aware that there are certain operating conditions in which time-out errors might occur. These errors usually result in the system reporting a disk failure for the associated REO Appliance disk drive or drives. (These errors might be reported as iSCSIPrT errors in the System Log of the Event Viewer. Examples include an Event ID 9 [Target did not respond in time for a SCSI request...] and Event ID 39 [Initiator sent a task management command to reset the target...]. Other symptoms might include “Lost Delayed Write Data” system error messages or similar error messages related to the REO Appliance disk drives.)

The reason that these disk time-out errors can occur is because the default I/O time-out value for Windows is 20 seconds, which is not sufficient to support the default iSCSI protocol time-out value of 60 seconds. *When you install and set up your REO Appliance, Overland strongly recommends that you set this value to 60 seconds.*

### To set the time-out value to 60 seconds

- 1 On the Windows system, run **regedit**.

**Warning:** If you edit the registry incorrectly, you might cause serious problems that require you to reinstall your operating system. **Edit the registry at your own risk.** Prior to making any changes, refer to the following Microsoft Knowledge Base article:  
<http://support.microsoft.com/default.aspx?scid=kb;en-us;322755>

- 2 In **HKEY\_LOCAL\_MACHINE\System\CurrentControlSet\Services\Disk**, edit or add the **TimeOutValue** entry to set it to 60 seconds in decimal format ((0000003c in hexadecimal).
  - To edit the value for the **TimeOutValue** entry if it already exists, double-click the entry, enter the new value, and click **OK**.
  - To add the **TimeOutValue** entry if it does not yet exist, right-click anywhere in the list of values, and then click **New > DWORD** value. Name the new value **TimeOutValue**, and then double-click it to edit the setting.

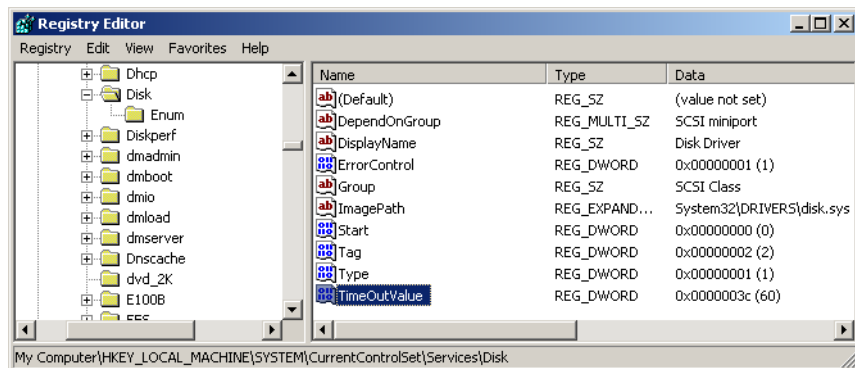



# 2 Setting Up the REO 9000

## CHAPTER

The main steps involved in setting up the REO Appliance include:

- Step 1** Unpacking the REO Appliance, and reviewing safety guidelines.
- Step 2** If you intend to position the REO Appliance in a rack, attaching the required components.
- Step 3** Connecting the REO Appliance to the management LAN.
- Step 4** Connecting the REO Appliance to the application and backup servers, SAN for the backup servers, or FC.
- Step 5** Connecting external SCSI devices.
- Step 6** Attaching the power cords.

## Preparing the REO Appliance



**Caution:** Due to the weight of each rack-mounted unit when it is fully extended, you should install units from the bottom up. Extending a unit that has empty spaces beneath it might cause the rack to tip forward or might cause personal injury. Overland Storage recommends that two people support and slide the unit in the rack.

**Vorsicht:** Aufgrund des Gewichtes eines Gerätes, welches für den Einbau in ein Rack gedacht ist, empfehlen wir Ihnen, dieses von unten nach oben in das Rack zu installieren. Wenn Sie ein Gerät aus dem Rack heraus ziehen, könnte es Ihnen entgleiten und so zu Verletzungen führen. Wir empfehlen den Ein- und Ausbau des Gerätes durch zwei Personen.

## 1 Unpack the REO Appliance.

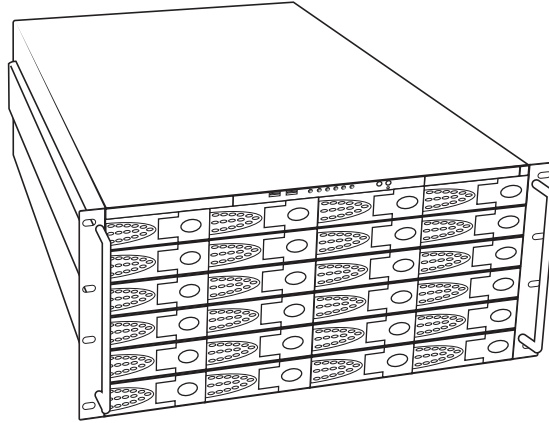

The shipping container contains the following:

- Overland Storage appliance chassis
  - Depending on which version of the product that you purchased, either 12 or 24 disk carriers and disk drives
  - Power cords (U.S.) (Approved cord sets shall be used in countries outside North America.)
  - Appliance face-plate
  - REO SoftKey
  - Rack-mount hardware
  - Documentation CD-ROM and poster
- 2 Review the following guidelines prior to positioning the REO Appliance physically within your network.
- Make sure that the REO Appliance is accessible.
  - Make sure there is unrestricted air flow around the unit and through the vents in the sides and rear of the case.
  - Route external cables so that they can be connected easily without blocking air vents or impeding air flow.
  - Protect the REO Appliance from extreme temperature and humidity. Overland Storage recommends that you install the REO Appliance in a clean, air-conditioned environment where water and moisture cannot enter the case of the REO Appliance. Keep the air as free from dust as possible.
  - Protect the REO Appliance from physical shock and vibration.
  - Make sure that the inlet air temperature within the rack remains below the specified limit of 95°F (35°C).
  - Keep the REO Appliance and cabling away from sources of electrical noise such as elevator shafts, stereo speakers, microwave ovens, air conditioning units, and even telephones. Electromagnetic fields can interfere with the signals on copper cabling and introduce errors, therefore slowing down the network.

## Positioning the REO Appliance in a Rack



**Caution:** Due to the weight of each rack-mounted unit when it is fully extended, you should install units from the bottom up. Extending a unit that has empty spaces beneath it might cause the rack to tip forward or might cause personal injury. Overland Storage recommends that two people support and slide the unit in the rack.

**Vorsicht:** Aufgrund des Gewichtes eines Gerätes, welches für den Einbau in ein Rack gedacht ist, empfehlen wir Ihnen, dieses von unten nach oben in das Rack zu installieren. Wenn Sie ein Gerät aus dem Rack heraus ziehen, könnte es Ihnen entgleiten und so zu Verletzungen führen. Wir empfehlen den Ein- und Ausbau des Gerätes durch zwei Personen.

### To install the unit in a rack

- 1 Separate each set of slides as follows:
  - Pull the outer slide toward the rear, along with the intermediate slide, until the inner slide-lock engages the intermediate slide.

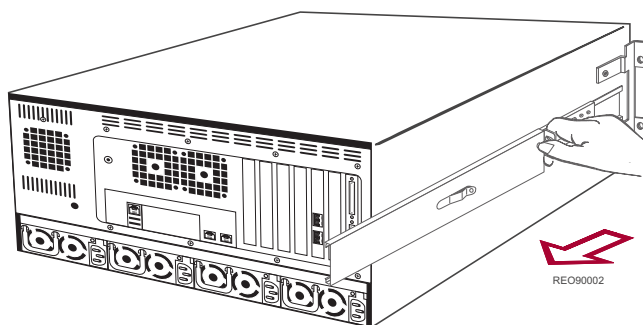

- Continue to pull the outer slide towards the rear until the outer slide-lock engages the intermediate slide. To permit the intermediate slide to continue to move toward the rear, press the inner slide-lock button. Continue to move the outer and intermediate slides toward the rear until they are separated from the inner slide.

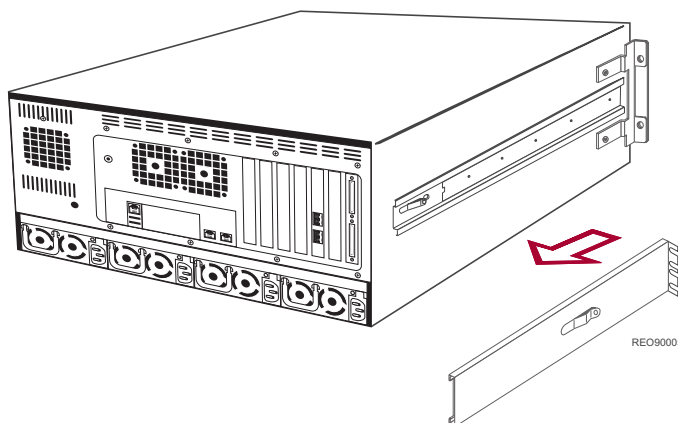

- 2 Locate the screw holes in the front and rear rails of the rack where the REO Appliance slides will be installed.

The unit uses 5U of rack space.

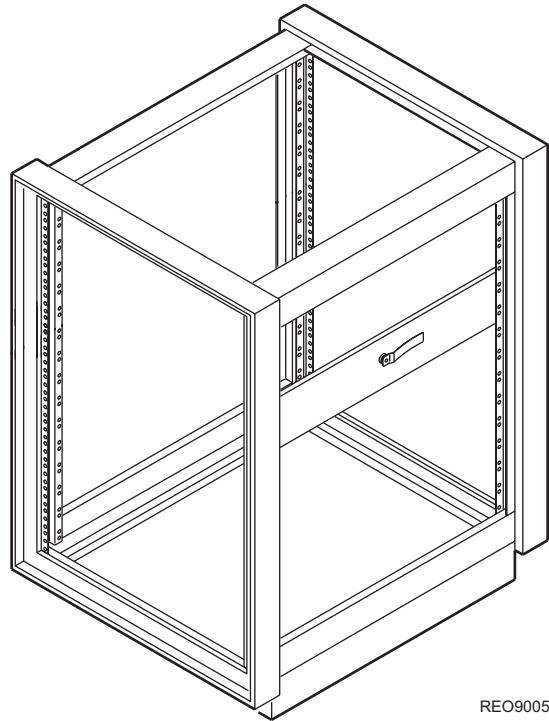
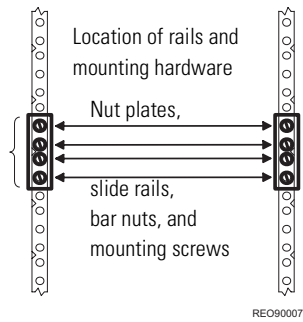

- 3 Fasten each outer slide by using 10-32 screws (with washers, if needed) and one nut plate.

Select slots in the mounting brackets so that the length of the assembly equals the distance between the front and rear rails of the rack.

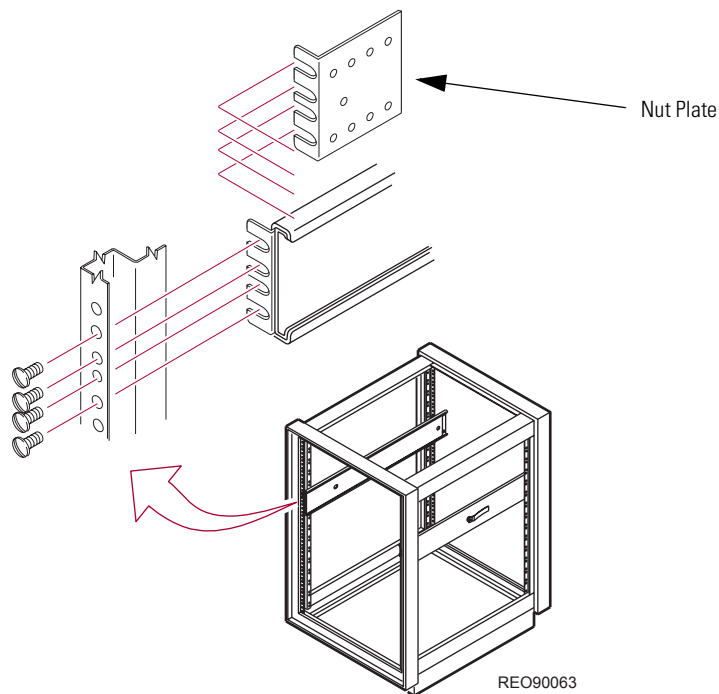

Note: When fastening the adjustable bracket, allow room for the slide to pass by the inside of the rack.

- 4 Tighten all the screws.
- 5 If they are not already locked in the extended position, pull the intermediate slides toward the front (out of the rack) so that they lock in the extended position.

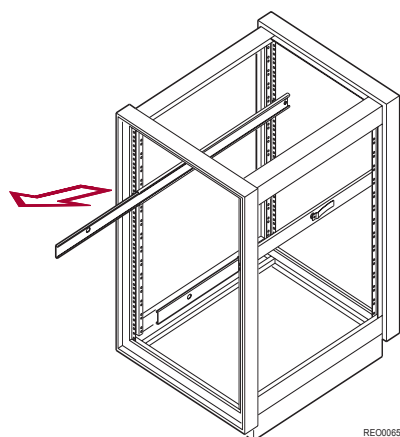

**Caution:** The disk drives for the REO Appliance are located in the front of the unit. The result being the majority of weight is distributed to the front of the REO Appliance. This next step should be performed by at least two people, or by using a mechanical lift. Make certain that when the REO Appliance is fully extended that a force of 20% of the rack's weight, but not more than lb. (Kg), applied in any direction other than upwards, does not cause the rack to overbalance.

- 6 At the front of the rack, lift the REO Appliance to its installed height, engage the inner slides mounted on the REO Appliance with the intermediate slides protruding from the rack, and slide the REO Appliance toward the rack until the inner slide-lock engages the intermediate slide.

This leaves the entire REO Appliance protruding from the rack, locked in position, supported by the slide rails.



**Caution:** With one unit installed in the rack and in the extended position, support might be required (to prevent the rack from tipping) until the unit is pushed completely into the rack. (The unit is shown in the middle of the rack for clarity.)

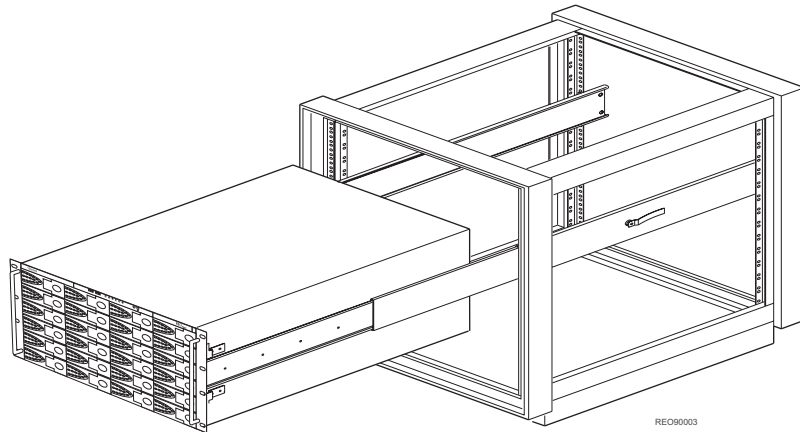

- 7 Press inward (toward the chassis) on each of the inner slide-locks to permit the intermediate slides to move toward the rack.
- 8 Slide the REO Appliance in and out several times, ensuring that the inner and outer slide locks engage, and that the REO Appliance chassis does not bind against the slides.

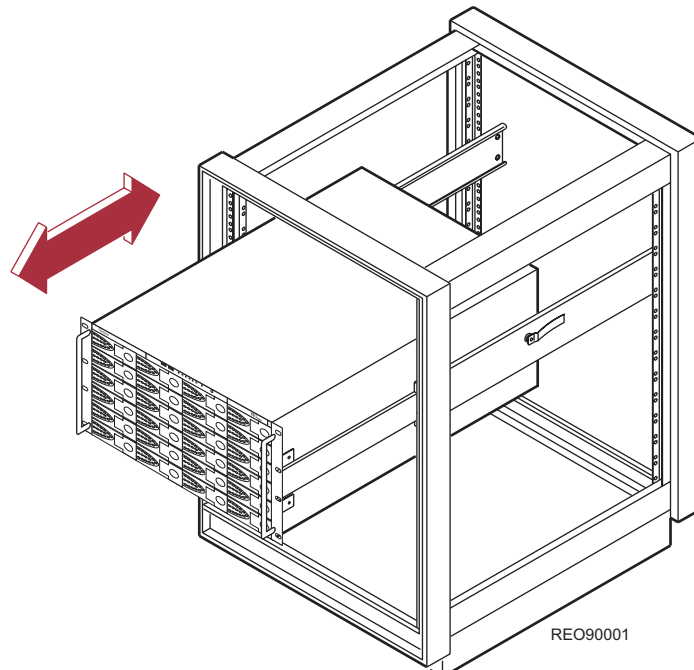



- 9 Slide the REO Appliance into the rack, and attach the captive screw on each panel extension (left and right sides) to the rack and nut plate.

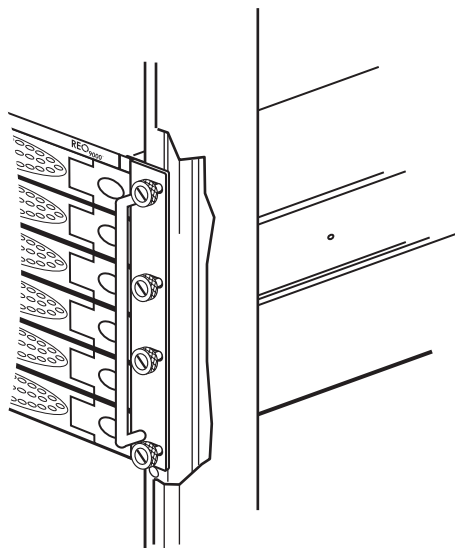

REO90006

## Installing the Disk Carriers and Disk Drives

The disk carriers, which contain the disk drives, are packaged separately, which allows you to insert them into the chassis after you have installed the chassis in the rack.

- 1 Remove the package of desiccant from each slot in the chassis.
- 2 Insert the first disk carrier in to the applicable slot in the chassis.
- 3 Close the disk carrier by doing the following:
  - a Make sure that the lever is in its fully extended, open position.
  - b Press the right side of the carrier into the slot.
  - c Press the lever in. Pressing the lever in draws the carrier fully into the slot and locks it in place.

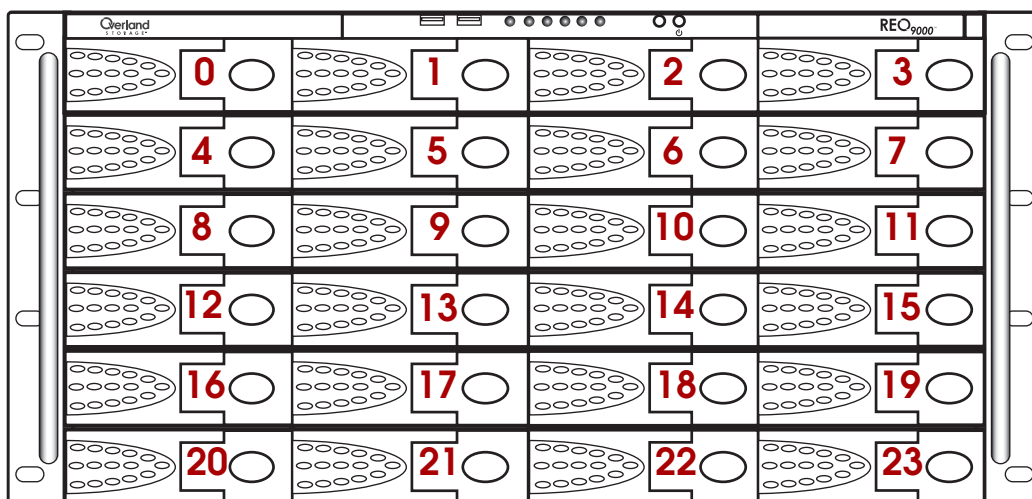

- 4 Repeat these steps for each disk carrier.
- 5 Attach the appliance face-plate.

## Connecting the REO Appliance to the Management LAN

- ▶ Using the **Management Port** (10/100), connect the REO Appliance to your LAN via the twisted-pair network cables.

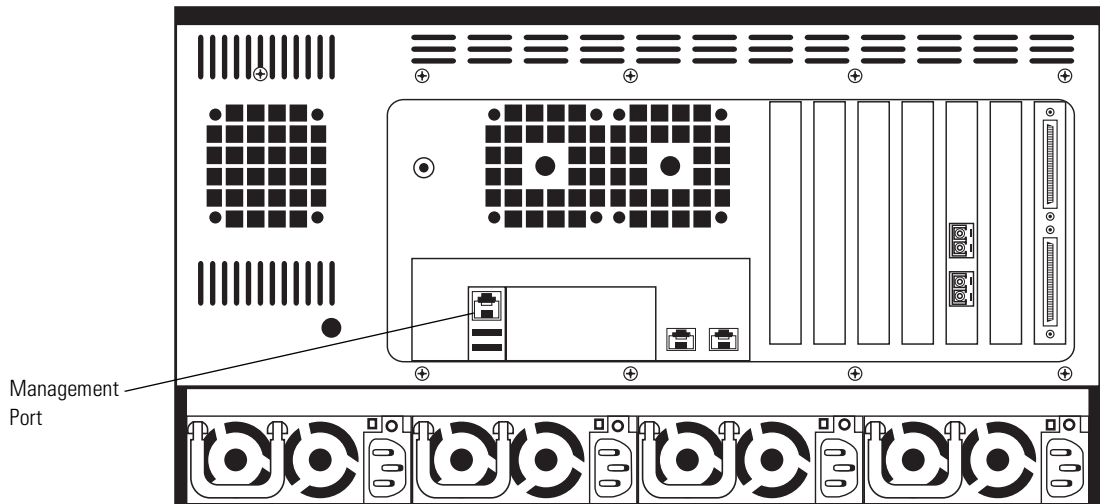

## Connecting the REO Appliance to the Network

Use the following instructions to connect your REO Appliance to your backup servers, SAN, or FC switch.

- 1 For iSCSI connectivity, use **Data Port 1** to connect the REO Appliance to a backup server via the twisted-pair network cables.

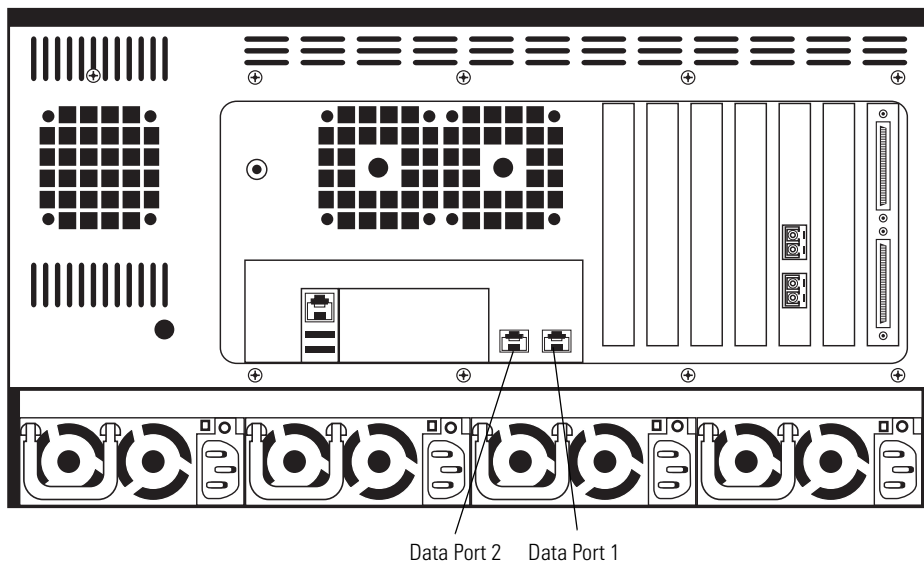

- 2 For additional iSCSI connectivity, use **Data Port 2** to connect the REO Appliance to a second backup server via the twisted-pair network cables. You can connect backup servers to the REO Appliance by using a direct-connect cable or by using a GbE switch.
- 3 If you are using FC, connect the **Fibre Channel Ports** on the rear of the REO Appliance to your FC switch or hub. The Fibre Channel ports on the back of the REO Appliance are numbered port 0 (bottom) and port 1 (top).

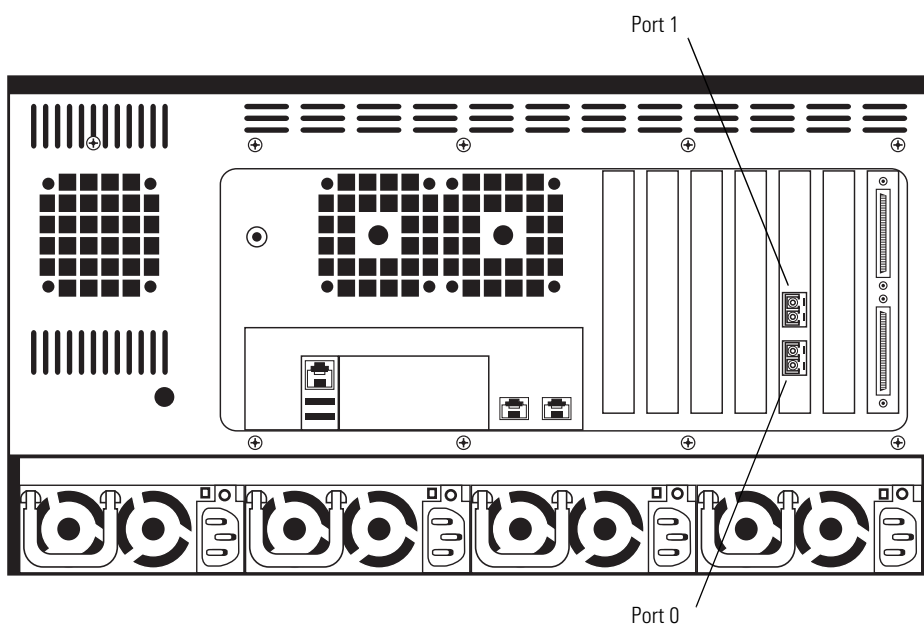

## Connecting External Devices to the REO Appliance

The REO Appliance includes two Ultra320 SCSI ports, which support SCSI devices such as medium changers and tape drives. You can use a chain formation to assign up to 15 SCSI IDs to each port.

### To connect SCSI devices to your REO Appliance

- ▶ On the rear of the REO Appliance, attach the applicable devices to the SCSI ports.

You must use an external 68-pin SCSI cable that includes a male connect with thumbscrews to connect a device to the port. (This cable is not included with the REO Appliance.)

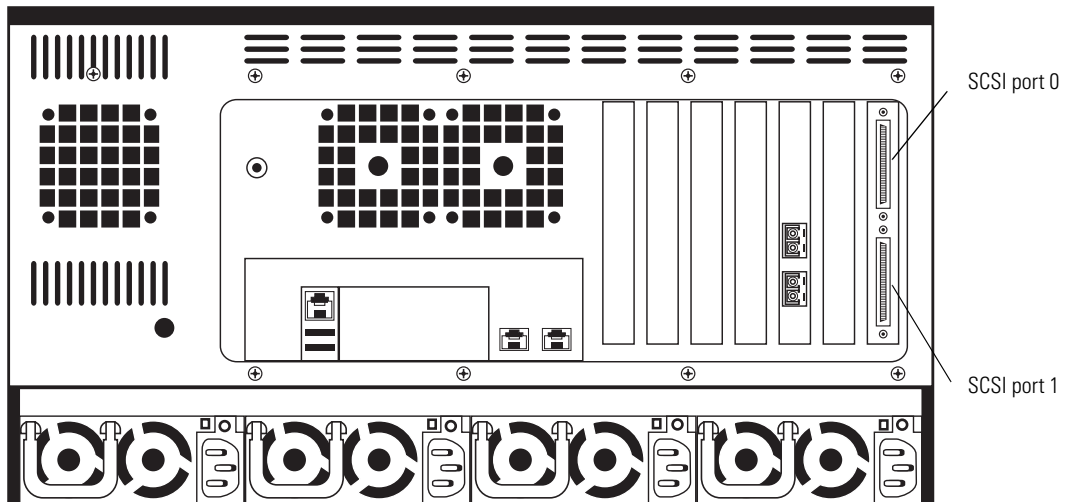

## Attaching the Power Cords

- 1 Attach all four power cords to the REO Appliance.
- 2 Plug the power cords in to an AC power source (do *not* turn the power on).

**Important:** You must connect and use all four power cords; if one of the cords is disconnected or malfunctioning, the REO Appliance beeps repeatedly until the situation is resolved. Overland Storage recommends that you use separate power mains for the power sources.

If you are not using Dynamic Host Configuration Protocol (DHCP), it is critical to the configuration process that you refrain from enabling power to the REO Appliance before completing the configuration steps specified in the next chapter.

Power problems can be the cause of serious failures and downtime in your network. Ensure that the power input to your system is clean and free from sags and surges to avoid unforeseen network outages. Overland Storage strongly recommends that you install power conditioning and an adequately rated uninterruptible power supply (UPS), especially in areas prone to blackouts, power dips, and electrical storms.

The REO Appliance is intended to be grounded. Ensure it is connected to earth ground during normal use. Installing proper grounding helps to avoid damage from lightning and power surges.

Each power supply contains:

- A socket for insertion of an AC line cord.
- A two-color LED for indicating the status of the power supply. When AC is applied to the supply and standby voltages are available, the LED becomes *red*. When all outputs are available, the LED becomes *green*. If the power supply fails, the LED becomes *red*.
- A latch for releasing the power supply from the REO Appliance.
- A handle for pulling the power supply out of the REO Appliance.
- A pair of fans for preventing the power supply from overheating.
- A feature that verifies the following (if not detected, an alarm signal sounds):
  - All output voltages V1 to V5 are within regulation.
  - The fans are operating normally.
  - The internal temperature of the power supply is normal.

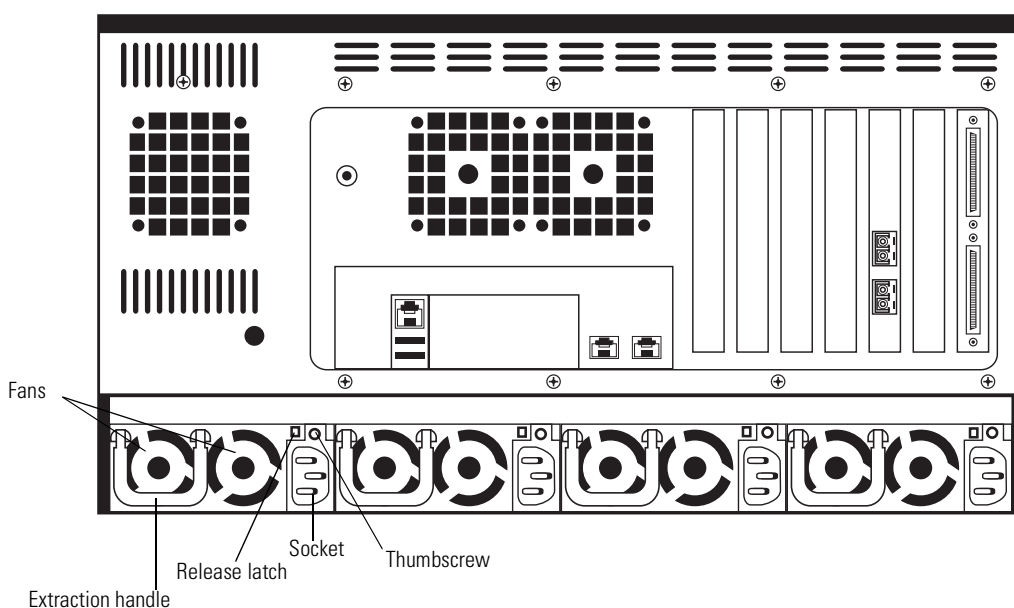

- 3 Complete the steps outlined in the next chapter, *Using the REO SoftKey to Start the REO 9000* on page 31.





# 3 | Using the REO SoftKey to Start the REO 9000

---

## CHAPTER

The main steps involved in using the key to start the REO Appliance include:

- Step 1** Making a backup copy of the key.
- Step 2** If your network does not use DHCP, manually editing the configuration and network files on the key.
- Step 3** Connecting the key to the REO Appliance.

## Understanding What the REO SoftKey Is

The REO SoftKey is a removable USB disk drive on a key ring. It contains the software and settings required for configuring the REO Appliance and must be inserted in the REO Appliance whenever you restart it (because the REO Appliance uses a Linux-based OS, the key is formatted using the virtual file allocation table [VFAT]). You can also use the REO SoftKey to download and install updates when they become available.

---

**Important:** If you purchased multiple units, note that the keys are *not* interchangeable

The simplest configuration can be achieved when your LAN uses DHCP on its own subnetwork (subnet). If your LAN does *not* use DHCP, you must manually edit the configuration file located on the REO SoftKey before continuing.

---

## Backing Up Your REO SoftKey (Pre-Configuration)

Make a backup copy of all the files on the REO SoftKey before *and* after you configure it.

- 1 Remove the cap from the REO SoftKey, and insert it into a USB port on a Windows 2000, 2003, or XP system that contains active virus-protection software.

Note: If you have not previously installed a USB mass-storage device, Windows displays a dialog box that indicates it has found new hardware and will automatically install the necessary drivers on your system.

- 2 Double-click **My Computer** on your desktop (or use Windows Explorer), and browse to the software-key disk drive.

The name of this disk drive varies based on your system configuration, but it will be called something like Removable Disk (G:).

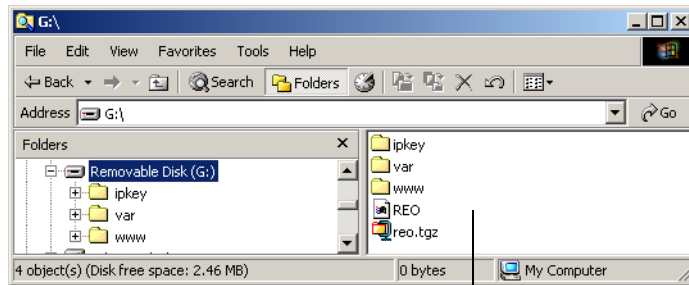

Make a backup copy of all the folders and files contained on the REO SoftKey.

- 3 Make a backup copy of all the data on the REO SoftKey, and store the copy in a secure location.
- 4 To determine your next step, choose one of the following:
  - If your LAN uses DHCP, continue from step 1 under *Connecting the REO SoftKey to the REO Appliance* on page 36.
  - If your LAN does not use DHCP, complete the steps outlined in the next section, *Editing the Configuration File (for a non-DHCP or UNIX Management System)*, before continuing.



## Editing the Configuration File (for a non-DHCP or UNIX Management System)

- 1 With the key still inserted into a USB port on a Windows 2000, 2003, or XP system that contains active virus-protection software, browse to the software-key disk drive.



- 2 Open the **ipkey** folder, and locate the **ifcfg-eth0** file.

The ifcfg-eth0 is the configuration file for the Management Port on the REO Appliance.

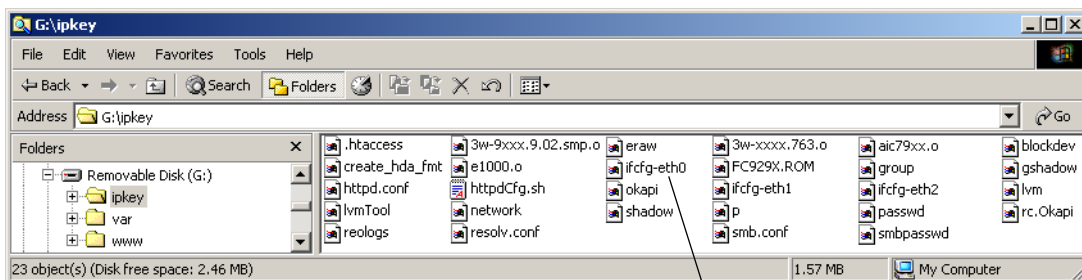

Open the ipkey folder, right-click ifcfg-eth0, and click Properties.

- 3 Right-click the **ifcfg-eth0** file, and click **Properties**.
- 4 On the **General** tab, if the **Read-only** check box is selected, clear it, and then click **OK**; otherwise, click **Cancel**.
- 5 Right-click the **ifcfg-eth0** file again, click **Open With**, and then select **WordPad** (or a comparable text editor).

Tip: Overland Storage recommends that you use WordPad, because it displays the configuration information in an easy-to-use format.

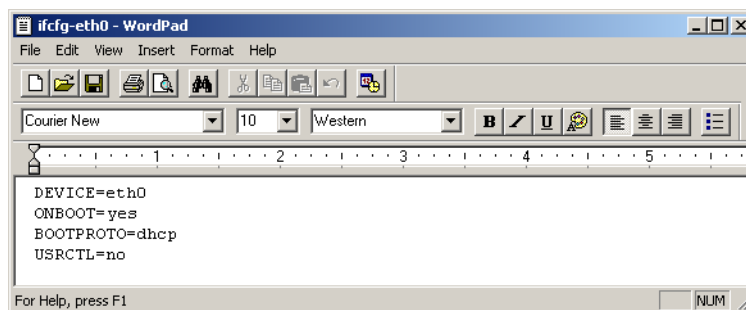

- 6 Make the following changes:
  - Change the **BOOTPROTO** field from dhcp to **static** (make sure that you enter it in lowercase).
  - After the **BOOTPROTO** line, enter lines for **IPADDR**, **NETMASK**, **NETWORK**, and **BROADCAST**, and, in each corresponding field, enter the IP address you selected for the management interface for the REO Appliance on your network.

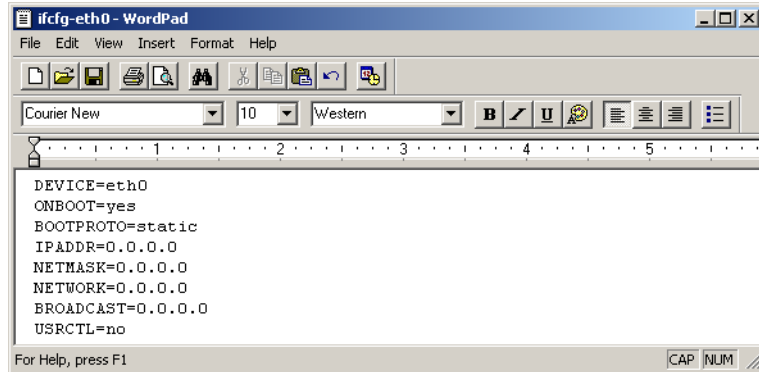

Note: You do not need to modify the other fields at this time.

- 7 Save the file; when asked if you want to replace the existing file, click **Yes**.
- 8 In the **ipkey** folder, locate the **network** file.

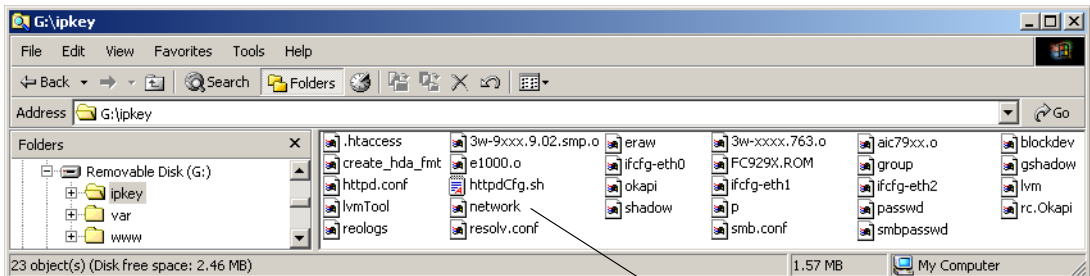

Locate and open the network file.

- 9 Right-click the **network** file, click **Open With**, and then select **WordPad**.

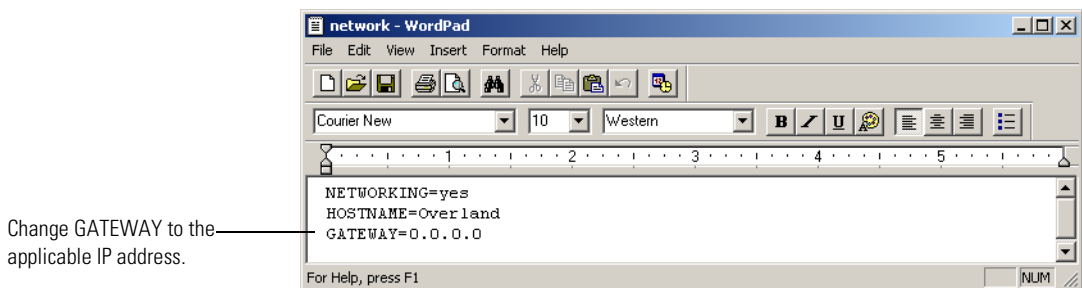

Change GATEWAY to the applicable IP address.

- 10 Change the contents of the **GATEWAY** field to the applicable IP address, and save and exit the file.

Note: If you are using a direct connection (private network), leave the **GATEWAY** address as 0.0.0.0.

- 11 Remove the REO SoftKey from the system by doing the following:



- a Double-click the **Unplug or Eject Hardware** icon, located in the system tray (lower-right corner of the task bar).
- b In the **Unplug or Eject Hardware** dialog box, select the device you want to unplug (the key is identified as **USB Mass Storage Device**), and click **Stop**.

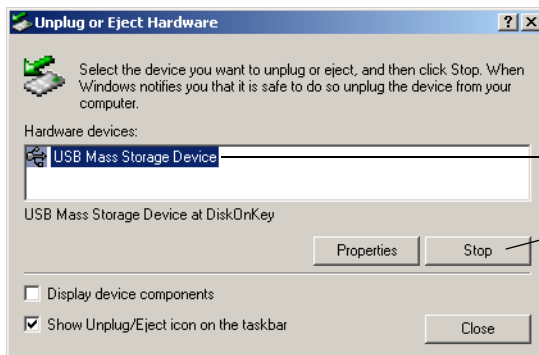

Select USB Mass Storage Device, and then click Stop.

- c In the **Stop a Hardware device** dialog box, select **USB Mass Storage Device**, and then click **OK**.



Select USB Mass Storage Device again, and then click OK.

- d When the message appears that indicates it is safe to remove the device, click **OK**, and remove the REO SoftKey.

- 12 Complete the steps outlined in the next section, *Connecting the REO SoftKey to the REO Appliance*.

# Connecting the REO SoftKey to the REO Appliance

- 1 Insert the REO SoftKey into the USB port located on the back of the REO Appliance.

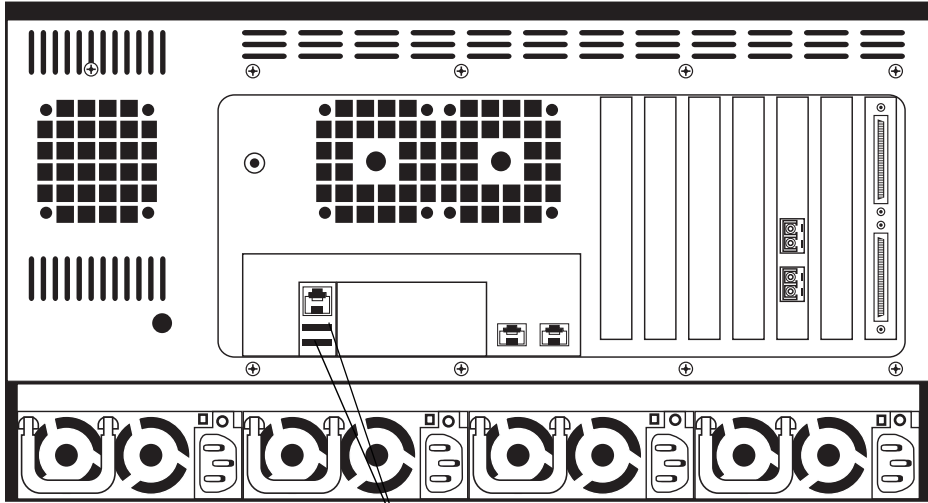

Insert the key.

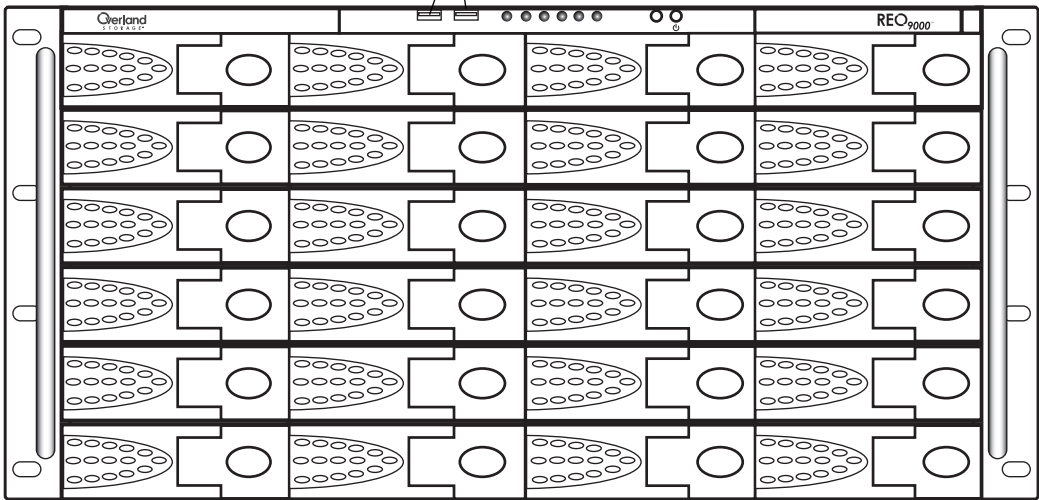

- 2 To turn the REO Appliance on, press and hold the power button for approximately 1 second.

**Important:** If you purchased multiple units, enable power to only one unit at this point; *you must set up one unit at a time.*

The power button is located on the front of the appliance. The power button is a momentary contact device that needs to be pressed and held for about 1 second to begin the power-up sequence.

Press and hold the power button for 1 second.

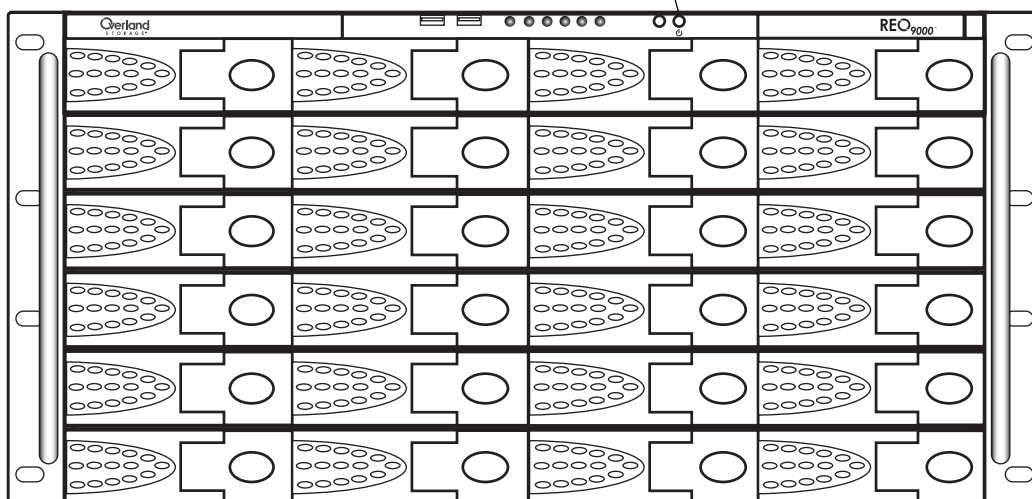

After you turn the power on, the REO Appliance performs a self-test process and loads the necessary information from the REO SoftKey. Following successful completion of the self-test, which takes several minutes, you should hear 3 beep tones.

- 3 Listen for the series of 3 beep tones spaced about 1 second apart.

---

**Important:** On startup, the REO Appliance might reach an error state and begin an endless loop of alerts. The pattern (2 beeps separated by a 1-second delay) repeats every 4 seconds. If this occurs, turn the appliance off and then back on. For more information, see *Perpetual Loop of Audio Alerts* on page 127.

---

- 4 After you hear the beep tones, proceed to the configuration steps outlined in the next chapter, *Configuring the Management System* on page 39.

If you are unable to hear the tones in your physical environment, wait approximately five minutes before continuing.

**Note:** You must leave the REO Appliance on and the REO SoftKey inserted while completing the configuration process for your application and backup servers.





# 4 | Configuring the Management System

CHAPTER

The main steps involved in configuring the management system include:

- Step 1** Establishing communication with the REO Appliance by mapping it to a drive letter (Windows only).
- Step 2** Verifying that the gateway and Management Port information are correct.
- Step 3** Entering the GbE Data Port, Fibre Channel, and system information.
- Step 4** Setting up your logon information.
- Step 5** Configuring e-mail alerts.
- Step 6** Setting the applicable time zone information.

The images shown in the following sections might appear slightly different if you are using a different browser or a UNIX-based system.

## Mapping a Network Drive to the REO Appliance (Windows Only)

To access the components used for installation and configuration of the REO Appliance, you must map a network drive from the REO Appliance to the system that will operate the REO Appliance console.

- 1 Make sure that REO SoftKey is still inserted in a USB port on the REO Appliance.
- 2 Right-click **My Computer** on your desktop, and click **Map Network Drive**.

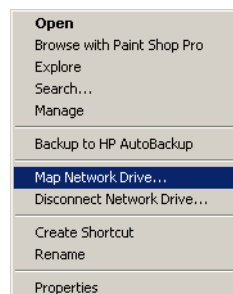

- 3 Use the default network drive displayed or select another drive from the list.

Tip: For consistency, Overland Storage recommends that you select a drive letter, such as drive Z, that is available to all systems on the backup network.

- 4 In the **Folder** box of the **Map Network Drive** dialog box, type \\REO\programs, and make sure that the **Reconnect at login** box is *cleared*.

Note: Because the folder might not be visible if you use the Browse button, Overland Storage recommends that you type \\REO\programs directly in the Folder text box.

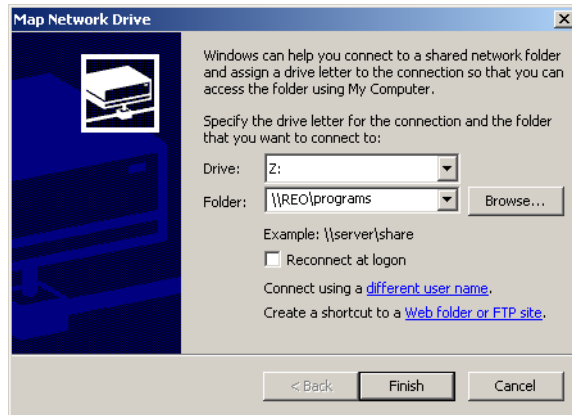

- 5 Click **Finish**.
- 6 If prompted for your name and password, enter the following *in case-sensitive format*:

Logon Name: Administrator  
Password: system



## Tracking Configuration Information

As you complete the configuration process by following the steps outlined in this and subsequent chapters, use the following forms to note what information you enter.

**Important:** This information will be useful if you have to reconfigure the REO Appliance for any reason, such as a lost or damaged REO SoftKey.

<i>Network Configuration Page</i>	
Default Gateway IP Address: _____	Data Port 2 IP Address: _____
Management Port IP Address: _____ Subnet Mask: _____ Network Address: _____ Broadcast Address: _____ DHCP: _____	Subnet Mask: _____ Network Address: _____ Broadcast Address: _____
Data Port 1 IP Address: _____ Subnet Mask: _____ Network Address: _____ Broadcast Address: _____	Fibre Channel Configuration WWPN(0) Link Speed: _____ Link Topology: _____ WWPN(1) Link Speed: _____ Link Topology: _____
<i>System Configuration Page</i>	
System Information Workgroup/Domain Name: _____ REO Name: _____ REO Description: _____	E-mail Notification Mail Address: _____ From Address: _____ Address for All: _____ Address for Critical: _____ Alert Frequency: _____

*REO Device Configuration Page*

## REO Device ID 0

Device Type: Disk, Tape, Dyn. Tape  
 ShareDevice: Yes or No  
 Tape Compression: Yes or No  
 Dyn. Tape Max. Size: \_\_\_\_\_  
 iSCSI Target Name: \_\_\_\_\_

Connection Type: iSCSI or FC  
 iSCSI Initiator Name: \_\_\_\_\_  
 Initiator IP Address: \_\_\_\_\_

## REO Device ID 1

Device Type: Disk, Tape, Dyn. Tape  
 ShareDevice: Yes or No  
 Tape Compression: Yes or No  
 Dyn. Tape Max. Size: \_\_\_\_\_  
 iSCSI Target Name: \_\_\_\_\_

Connection Type: iSCSI or FC  
 iSCSI Initiator Name: \_\_\_\_\_  
 Initiator IP Address: \_\_\_\_\_

## REO Device ID 2

Device Type: Disk, Tape, Dyn. Tape  
 ShareDevice: Yes or No  
 Tape Compression: Yes or No  
 Dyn. Tape Max. Size: \_\_\_\_\_  
 iSCSI Target Name: \_\_\_\_\_

Connection Type: iSCSI or FC  
 iSCSI Initiator Name: \_\_\_\_\_  
 Initiator IP Address: \_\_\_\_\_

## REO Device ID 3

Device Type: Disk, Tape, Dyn. Tape  
 ShareDevice: Yes or No  
 Tape Compression: Yes or No  
 Dyn. Tape Max. Size: \_\_\_\_\_  
 iSCSI Target Name: \_\_\_\_\_

Connection Type: iSCSI or FC  
 iSCSI Initiator Name: \_\_\_\_\_  
 Initiator IP Address: \_\_\_\_\_

## REO Device ID 4

Device Type: Disk, Tape, Dyn. Tape  
 ShareDevice: Yes or No  
 Tape Compression: Yes or No  
 Dyn. Tape Max. Size: \_\_\_\_\_  
 iSCSI Target Name: \_\_\_\_\_

Connection Type: iSCSI or FC  
 iSCSI Initiator Name: \_\_\_\_\_  
 Initiator IP Address: \_\_\_\_\_

## REO Device ID 5

Device Type: Disk, Tape, Dyn. Tape  
 ShareDevice: Yes or No  
 Tape Compression: Yes or No  
 Dyn. Tape Max. Size: \_\_\_\_\_  
 iSCSI Target Name: \_\_\_\_\_

Connection Type: iSCSI or FC  
 iSCSI Initiator Name: \_\_\_\_\_  
 Initiator IP Address: \_\_\_\_\_

## REO Device ID 6

Device Type: Disk, Tape, Dyn. Tape  
 ShareDevice: Yes or No  
 Tape Compression: Yes or No  
 Dyn. Tape Max. Size: \_\_\_\_\_  
 iSCSI Target Name: \_\_\_\_\_

Connection Type: iSCSI or FC  
 iSCSI Initiator Name: \_\_\_\_\_  
 Initiator IP Address: \_\_\_\_\_

## REO Device ID 7

Device Type: Disk, Tape, Dyn. Tape  
 ShareDevice: Yes or No  
 Tape Compression: Yes or No  
 Dyn. Tape Max. Size: \_\_\_\_\_  
 iSCSI Target Name: \_\_\_\_\_

Connection Type: iSCSI or FC  
 iSCSI Initiator Name: \_\_\_\_\_  
 Initiator IP Address: \_\_\_\_\_

*REO Device Configuration Page (continued)*

## REO Device ID 8

Device Type: Disk, Tape, Dyn. Tape  
 ShareDevice: Yes or No  
 Tape Compression: Yes or No  
 Dyn. Tape Max. Size: \_\_\_\_\_  
 iSCSI Target Name: \_\_\_\_\_

Connection Type: iSCSI or FC  
 iSCSI Initiator Name: \_\_\_\_\_  
 Initiator IP Address: \_\_\_\_\_

## REO Device ID 9

Device Type: Disk, Tape, Dyn. Tape  
 ShareDevice: Yes or No  
 Tape Compression: Yes or No  
 Dyn. Tape Max. Size: \_\_\_\_\_  
 iSCSI Target Name: \_\_\_\_\_

Connection Type: iSCSI or FC  
 iSCSI Initiator Name: \_\_\_\_\_  
 Initiator IP Address: \_\_\_\_\_

## REO Device ID 10

Device Type: Disk, Tape, Dyn. Tape  
 ShareDevice: Yes or No  
 Tape Compression: Yes or No  
 Dyn. Tape Max. Size: \_\_\_\_\_  
 iSCSI Target Name: \_\_\_\_\_

Connection Type: iSCSI or FC  
 iSCSI Initiator Name: \_\_\_\_\_  
 Initiator IP Address: \_\_\_\_\_

## REO Device ID 11

Device Type: Disk, Tape, Dyn. Tape  
 ShareDevice: Yes or No  
 Tape Compression: Yes or No  
 Dyn. Tape Max. Size: \_\_\_\_\_  
 iSCSI Target Name: \_\_\_\_\_

Connection Type: iSCSI or FC  
 iSCSI Initiator Name: \_\_\_\_\_  
 Initiator IP Address: \_\_\_\_\_

## REO Device ID 12

Device Type: Disk, Tape, Dyn. Tape  
 ShareDevice: Yes or No  
 Tape Compression: Yes or No  
 Dyn. Tape Max. Size: \_\_\_\_\_  
 iSCSI Target Name: \_\_\_\_\_

Connection Type: iSCSI or FC  
 iSCSI Initiator Name: \_\_\_\_\_  
 Initiator IP Address: \_\_\_\_\_

## REO Device ID 13

Device Type: Disk, Tape, Dyn. Tape  
 ShareDevice: Yes or No  
 Tape Compression: Yes or No  
 Dyn. Tape Max. Size: \_\_\_\_\_  
 iSCSI Target Name: \_\_\_\_\_

Connection Type: iSCSI or FC  
 iSCSI Initiator Name: \_\_\_\_\_  
 Initiator IP Address: \_\_\_\_\_

## REO Device ID 14

Device Type: Disk, Tape, Dyn. Tape  
 ShareDevice: Yes or No  
 Tape Compression: Yes or No  
 Dyn. Tape Max. Size: \_\_\_\_\_  
 iSCSI Target Name: \_\_\_\_\_

Connection Type: iSCSI or FC  
 iSCSI Initiator Name: \_\_\_\_\_  
 Initiator IP Address: \_\_\_\_\_

## REO Device ID 15

Device Type: Disk, Tape, Dyn. Tape  
 ShareDevice: Yes or No  
 Tape Compression: Yes or No  
 Dyn. Tape Max. Size: \_\_\_\_\_  
 iSCSI Target Name: \_\_\_\_\_

Connection Type: iSCSI or FC  
 iSCSI Initiator Name: \_\_\_\_\_  
 Initiator IP Address: \_\_\_\_\_

*REO Device Configuration Page (continued)*

REO Device ID 16

Device Type: Disk, Tape, Dyn. Tape  
 ShareDevice: Yes or No  
 Tape Compression: Yes or No  
 Dyn. Tape Max. Size: \_\_\_\_\_  
 iSCSI Target Name: \_\_\_\_\_

Connection Type: iSCSI or FC  
 iSCSI Initiator Name: \_\_\_\_\_  
 Initiator IP Address: \_\_\_\_\_

REO Device ID 17

Device Type: Disk, Tape, Dyn. Tape  
 ShareDevice: Yes or No  
 Tape Compression: Yes or No  
 Dyn. Tape Max. Size: \_\_\_\_\_  
 iSCSI Target Name: \_\_\_\_\_

Connection Type: iSCSI or FC  
 iSCSI Initiator Name: \_\_\_\_\_  
 Initiator IP Address: \_\_\_\_\_

REO Device ID 18

Device Type: Disk, Tape, Dyn. Tape  
 ShareDevice: Yes or No  
 Tape Compression: Yes or No  
 Dyn. Tape Max. Size: \_\_\_\_\_  
 iSCSI Target Name: \_\_\_\_\_

Connection Type: iSCSI or FC  
 iSCSI Initiator Name: \_\_\_\_\_  
 Initiator IP Address: \_\_\_\_\_

REO Device ID 19

Device Type: Disk, Tape, Dyn. Tape  
 ShareDevice: Yes or No  
 Tape Compression: Yes or No  
 Dyn. Tape Max. Size: \_\_\_\_\_  
 iSCSI Target Name: \_\_\_\_\_

Connection Type: iSCSI or FC  
 iSCSI Initiator Name: \_\_\_\_\_  
 Initiator IP Address: \_\_\_\_\_

REO Device ID 20

Device Type: Disk, Tape, Dyn. Tape  
 ShareDevice: Yes or No  
 Tape Compression: Yes or No  
 Dyn. Tape Max. Size: \_\_\_\_\_  
 iSCSI Target Name: \_\_\_\_\_

Connection Type: iSCSI or FC  
 iSCSI Initiator Name: \_\_\_\_\_  
 Initiator IP Address: \_\_\_\_\_

REO Device ID 21

Device Type: Disk, Tape, Dyn. Tape  
 ShareDevice: Yes or No  
 Tape Compression: Yes or No  
 Dyn. Tape Max. Size: \_\_\_\_\_  
 iSCSI Target Name: \_\_\_\_\_

Connection Type: iSCSI or FC  
 iSCSI Initiator Name: \_\_\_\_\_  
 Initiator IP Address: \_\_\_\_\_

REO Device ID 22

Device Type: Disk, Tape, Dyn. Tape  
 ShareDevice: Yes or No  
 Tape Compression: Yes or No  
 Dyn. Tape Max. Size: \_\_\_\_\_  
 iSCSI Target Name: \_\_\_\_\_

Connection Type: iSCSI or FC  
 iSCSI Initiator Name: \_\_\_\_\_  
 Initiator IP Address: \_\_\_\_\_

REO Device ID 23

Device Type: Disk, Tape, Dyn. Tape  
 ShareDevice: Yes or No  
 Tape Compression: Yes or No  
 Dyn. Tape Max. Size: \_\_\_\_\_  
 iSCSI Target Name: \_\_\_\_\_

Connection Type: iSCSI or FC  
 iSCSI Initiator Name: \_\_\_\_\_  
 Initiator IP Address: \_\_\_\_\_

*REO Device Configuration Page (continued)*

## REO Device ID 24

Device Type: Disk, Tape, Dyn. Tape  
 ShareDevice: Yes or No  
 Tape Compression: Yes or No  
 Dyn. Tape Max. Size: \_\_\_\_\_  
 iSCSI Target Name: \_\_\_\_\_

Connection Type: iSCSI or FC  
 iSCSI Initiator Name: \_\_\_\_\_  
 Initiator IP Address: \_\_\_\_\_

## REO Device ID 25

Device Type: Disk, Tape, Dyn. Tape  
 ShareDevice: Yes or No  
 Tape Compression: Yes or No  
 Dyn. Tape Max. Size: \_\_\_\_\_  
 iSCSI Target Name: \_\_\_\_\_

Connection Type: iSCSI or FC  
 iSCSI Initiator Name: \_\_\_\_\_  
 Initiator IP Address: \_\_\_\_\_

## REO Device ID 26

Device Type: Disk, Tape, Dyn. Tape  
 ShareDevice: Yes or No  
 Tape Compression: Yes or No  
 Dyn. Tape Max. Size: \_\_\_\_\_  
 iSCSI Target Name: \_\_\_\_\_

Connection Type: iSCSI or FC  
 iSCSI Initiator Name: \_\_\_\_\_  
 Initiator IP Address: \_\_\_\_\_

## REO Device ID 27

Device Type: Disk, Tape, Dyn. Tape  
 ShareDevice: Yes or No  
 Tape Compression: Yes or No  
 Dyn. Tape Max. Size: \_\_\_\_\_  
 iSCSI Target Name: \_\_\_\_\_

Connection Type: iSCSI or FC  
 iSCSI Initiator Name: \_\_\_\_\_  
 Initiator IP Address: \_\_\_\_\_

## REO Device ID 28

Device Type: Disk, Tape, Dyn. Tape  
 ShareDevice: Yes or No  
 Tape Compression: Yes or No  
 Dyn. Tape Max. Size: \_\_\_\_\_  
 iSCSI Target Name: \_\_\_\_\_

Connection Type: iSCSI or FC  
 iSCSI Initiator Name: \_\_\_\_\_  
 Initiator IP Address: \_\_\_\_\_

## REO Device ID 29

Device Type: Disk, Tape, Dyn. Tape  
 ShareDevice: Yes or No  
 Tape Compression: Yes or No  
 Dyn. Tape Max. Size: \_\_\_\_\_  
 iSCSI Target Name: \_\_\_\_\_

Connection Type: iSCSI or FC  
 iSCSI Initiator Name: \_\_\_\_\_  
 Initiator IP Address: \_\_\_\_\_

## REO Device ID 30

Device Type: Disk, Tape, Dyn. Tape  
 ShareDevice: Yes or No  
 Tape Compression: Yes or No  
 Dyn. Tape Max. Size: \_\_\_\_\_  
 iSCSI Target Name: \_\_\_\_\_

Connection Type: iSCSI or FC  
 iSCSI Initiator Name: \_\_\_\_\_  
 Initiator IP Address: \_\_\_\_\_

## REO Device ID 31

Device Type: Disk, Tape, Dyn. Tape  
 ShareDevice: Yes or No  
 Tape Compression: Yes or No  
 Dyn. Tape Max. Size: \_\_\_\_\_  
 iSCSI Target Name: \_\_\_\_\_

Connection Type: iSCSI or FC  
 iSCSI Initiator Name: \_\_\_\_\_  
 Initiator IP Address: \_\_\_\_\_

*REO Device Configuration Page (continued)*

REO Device ID 32

Device Type: Disk, Tape, Dyn. Tape  
 ShareDevice: Yes or No  
 Tape Compression: Yes or No  
 Dyn. Tape Max. Size: \_\_\_\_\_  
 iSCSI Target Name: \_\_\_\_\_

Connection Type: iSCSI or FC  
 iSCSI Initiator Name: \_\_\_\_\_  
 Initiator IP Address: \_\_\_\_\_

REO Device ID 33

Device Type: Disk, Tape, Dyn. Tape  
 ShareDevice: Yes or No  
 Tape Compression: Yes or No  
 Dyn. Tape Max. Size: \_\_\_\_\_  
 iSCSI Target Name: \_\_\_\_\_

Connection Type: iSCSI or FC  
 iSCSI Initiator Name: \_\_\_\_\_  
 Initiator IP Address: \_\_\_\_\_

REO Device ID 34

Device Type: Disk, Tape, Dyn. Tape  
 ShareDevice: Yes or No  
 Tape Compression: Yes or No  
 Dyn. Tape Max. Size: \_\_\_\_\_  
 iSCSI Target Name: \_\_\_\_\_

Connection Type: iSCSI or FC  
 iSCSI Initiator Name: \_\_\_\_\_  
 Initiator IP Address: \_\_\_\_\_

REO Device ID 35

Device Type: Disk, Tape, Dyn. Tape  
 ShareDevice: Yes or No  
 Tape Compression: Yes or No  
 Dyn. Tape Max. Size: \_\_\_\_\_  
 iSCSI Target Name: \_\_\_\_\_

Connection Type: iSCSI or FC  
 iSCSI Initiator Name: \_\_\_\_\_  
 Initiator IP Address: \_\_\_\_\_

REO Device ID 36

Device Type: Disk, Tape, Dyn. Tape  
 ShareDevice: Yes or No  
 Tape Compression: Yes or No  
 Dyn. Tape Max. Size: \_\_\_\_\_  
 iSCSI Target Name: \_\_\_\_\_

Connection Type: iSCSI or FC  
 iSCSI Initiator Name: \_\_\_\_\_  
 Initiator IP Address: \_\_\_\_\_

REO Device ID 37

Device Type: Disk, Tape, Dyn. Tape  
 ShareDevice: Yes or No  
 Tape Compression: Yes or No  
 Dyn. Tape Max. Size: \_\_\_\_\_  
 iSCSI Target Name: \_\_\_\_\_

Connection Type: iSCSI or FC  
 iSCSI Initiator Name: \_\_\_\_\_  
 Initiator IP Address: \_\_\_\_\_

REO Device ID 38

Device Type: Disk, Tape, Dyn. Tape  
 ShareDevice: Yes or No  
 Tape Compression: Yes or No  
 Dyn. Tape Max. Size: \_\_\_\_\_  
 iSCSI Target Name: \_\_\_\_\_

Connection Type: iSCSI or FC  
 iSCSI Initiator Name: \_\_\_\_\_  
 Initiator IP Address: \_\_\_\_\_

REO Device ID 39

Device Type: Disk, Tape, Dyn. Tape  
 ShareDevice: Yes or No  
 Tape Compression: Yes or No  
 Dyn. Tape Max. Size: \_\_\_\_\_  
 iSCSI Target Name: \_\_\_\_\_

Connection Type: iSCSI or FC  
 iSCSI Initiator Name: \_\_\_\_\_  
 Initiator IP Address: \_\_\_\_\_

*REO Device Configuration Page (continued)*

REO Device ID 40

Device Type: Disk, Tape, Dyn. Tape  
 ShareDevice: Yes or No  
 Tape Compression: Yes or No  
 Dyn. Tape Max. Size: \_\_\_\_\_  
 iSCSI Target Name: \_\_\_\_\_

Connection Type: iSCSI or FC  
 iSCSI Initiator Name: \_\_\_\_\_  
 Initiator IP Address: \_\_\_\_\_

REO Device ID 41

Device Type: Disk, Tape, Dyn. Tape  
 ShareDevice: Yes or No  
 Tape Compression: Yes or No  
 Dyn. Tape Max. Size: \_\_\_\_\_  
 iSCSI Target Name: \_\_\_\_\_

Connection Type: iSCSI or FC  
 iSCSI Initiator Name: \_\_\_\_\_  
 Initiator IP Address: \_\_\_\_\_

REO Device ID 42

Device Type: Disk, Tape, Dyn. Tape  
 ShareDevice: Yes or No  
 Tape Compression: Yes or No  
 Dyn. Tape Max. Size: \_\_\_\_\_  
 iSCSI Target Name: \_\_\_\_\_

Connection Type: iSCSI or FC  
 iSCSI Initiator Name: \_\_\_\_\_  
 Initiator IP Address: \_\_\_\_\_

REO Device ID 43

Device Type: Disk, Tape, Dyn. Tape  
 ShareDevice: Yes or No  
 Tape Compression: Yes or No  
 Dyn. Tape Max. Size: \_\_\_\_\_  
 iSCSI Target Name: \_\_\_\_\_

Connection Type: iSCSI or FC  
 iSCSI Initiator Name: \_\_\_\_\_  
 Initiator IP Address: \_\_\_\_\_

REO Device ID 44

Device Type: Disk, Tape, Dyn. Tape  
 ShareDevice: Yes or No  
 Tape Compression: Yes or No  
 Dyn. Tape Max. Size: \_\_\_\_\_  
 iSCSI Target Name: \_\_\_\_\_

Connection Type: iSCSI or FC  
 iSCSI Initiator Name: \_\_\_\_\_  
 Initiator IP Address: \_\_\_\_\_

REO Device ID 45

Device Type: Disk, Tape, Dyn. Tape  
 ShareDevice: Yes or No  
 Tape Compression: Yes or No  
 Dyn. Tape Max. Size: \_\_\_\_\_  
 iSCSI Target Name: \_\_\_\_\_

Connection Type: iSCSI or FC  
 iSCSI Initiator Name: \_\_\_\_\_  
 Initiator IP Address: \_\_\_\_\_

REO Device ID 46

Device Type: Disk, Tape, Dyn. Tape  
 ShareDevice: Yes or No  
 Tape Compression: Yes or No  
 Dyn. Tape Max. Size: \_\_\_\_\_  
 iSCSI Target Name: \_\_\_\_\_

Connection Type: iSCSI or FC  
 iSCSI Initiator Name: \_\_\_\_\_  
 Initiator IP Address: \_\_\_\_\_

REO Device ID 47

Device Type: Disk, Tape, Dyn. Tape  
 ShareDevice: Yes or No  
 Tape Compression: Yes or No  
 Dyn. Tape Max. Size: \_\_\_\_\_  
 iSCSI Target Name: \_\_\_\_\_

Connection Type: iSCSI or FC  
 iSCSI Initiator Name: \_\_\_\_\_  
 Initiator IP Address: \_\_\_\_\_

*REO Device Configuration Page (continued)*

REO Device ID 48

Device Type: Disk, Tape, Dyn. Tape

ShareDevice: Yes or No

Tape Compression: Yes or No

Dyn. Tape Max. Size: \_\_\_\_\_

iSCSI Target Name: \_\_\_\_\_

Connection Type: iSCSI or FC

iSCSI Initiator Name: \_\_\_\_\_

Initiator IP Address: \_\_\_\_\_

REO Device ID 49

Device Type: Disk, Tape, Dyn. Tape

ShareDevice: Yes or No

Tape Compression: Yes or No

Dyn. Tape Max. Size: \_\_\_\_\_

iSCSI Target Name: \_\_\_\_\_

Connection Type: iSCSI or FC

iSCSI Initiator Name: \_\_\_\_\_

Initiator IP Address: \_\_\_\_\_

REO Device ID 50

Device Type: Disk, Tape, Dyn. Tape

ShareDevice: Yes or No

Tape Compression: Yes or No

Dyn. Tape Max. Size: \_\_\_\_\_

iSCSI Target Name: \_\_\_\_\_

Connection Type: iSCSI or FC

iSCSI Initiator Name: \_\_\_\_\_

Initiator IP Address: \_\_\_\_\_

REO Device ID 51

Device Type: Disk, Tape, Dyn. Tape

ShareDevice: Yes or No

Tape Compression: Yes or No

Dyn. Tape Max. Size: \_\_\_\_\_

iSCSI Target Name: \_\_\_\_\_

Connection Type: iSCSI or FC

iSCSI Initiator Name: \_\_\_\_\_

Initiator IP Address: \_\_\_\_\_

REO Device ID 52

Device Type: Disk, Tape, Dyn. Tape

ShareDevice: Yes or No

Tape Compression: Yes or No

Dyn. Tape Max. Size: \_\_\_\_\_

iSCSI Target Name: \_\_\_\_\_

Connection Type: iSCSI or FC

iSCSI Initiator Name: \_\_\_\_\_

Initiator IP Address: \_\_\_\_\_

REO Device ID 53

Device Type: Disk, Tape, Dyn. Tape

ShareDevice: Yes or No

Tape Compression: Yes or No

Dyn. Tape Max. Size: \_\_\_\_\_

iSCSI Target Name: \_\_\_\_\_

Connection Type: iSCSI or FC

iSCSI Initiator Name: \_\_\_\_\_

Initiator IP Address: \_\_\_\_\_

REO Device ID 54

Device Type: Disk, Tape, Dyn. Tape

ShareDevice: Yes or No

Tape Compression: Yes or No

Dyn. Tape Max. Size: \_\_\_\_\_

iSCSI Target Name: \_\_\_\_\_

Connection Type: iSCSI or FC

iSCSI Initiator Name: \_\_\_\_\_

Initiator IP Address: \_\_\_\_\_

REO Device ID 55

Device Type: Disk, Tape, Dyn. Tape

ShareDevice: Yes or No

Tape Compression: Yes or No

Dyn. Tape Max. Size: \_\_\_\_\_

iSCSI Target Name: \_\_\_\_\_

Connection Type: iSCSI or FC

iSCSI Initiator Name: \_\_\_\_\_

Initiator IP Address: \_\_\_\_\_



*REO Device Configuration Page (continued)*

REO Device ID 56

Device Type: Disk, Tape, Dyn. Tape  
 ShareDevice: Yes or No  
 Tape Compression: Yes or No  
 Dyn. Tape Max. Size: \_\_\_\_\_  
 iSCSI Target Name: \_\_\_\_\_

Connection Type: iSCSI or FC  
 iSCSI Initiator Name: \_\_\_\_\_  
 Initiator IP Address: \_\_\_\_\_

REO Device ID 57

Device Type: Disk, Tape, Dyn. Tape  
 ShareDevice: Yes or No  
 Tape Compression: Yes or No  
 Dyn. Tape Max. Size: \_\_\_\_\_  
 iSCSI Target Name: \_\_\_\_\_

Connection Type: iSCSI or FC  
 iSCSI Initiator Name: \_\_\_\_\_  
 Initiator IP Address: \_\_\_\_\_

REO Device ID 58

Device Type: Disk, Tape, Dyn. Tape  
 ShareDevice: Yes or No  
 Tape Compression: Yes or No  
 Dyn. Tape Max. Size: \_\_\_\_\_  
 iSCSI Target Name: \_\_\_\_\_

Connection Type: iSCSI or FC  
 iSCSI Initiator Name: \_\_\_\_\_  
 Initiator IP Address: \_\_\_\_\_

REO Device ID 59

Device Type: Disk, Tape, Dyn. Tape  
 ShareDevice: Yes or No  
 Tape Compression: Yes or No  
 Dyn. Tape Max. Size: \_\_\_\_\_  
 iSCSI Target Name: \_\_\_\_\_

Connection Type: iSCSI or FC  
 iSCSI Initiator Name: \_\_\_\_\_  
 Initiator IP Address: \_\_\_\_\_

REO Device ID 60

Device Type: Disk, Tape, Dyn. Tape  
 ShareDevice: Yes or No  
 Tape Compression: Yes or No  
 Dyn. Tape Max. Size: \_\_\_\_\_  
 iSCSI Target Name: \_\_\_\_\_

Connection Type: iSCSI or FC  
 iSCSI Initiator Name: \_\_\_\_\_  
 Initiator IP Address: \_\_\_\_\_

REO Device ID 61

Device Type: Disk, Tape, Dyn. Tape  
 ShareDevice: Yes or No  
 Tape Compression: Yes or No  
 Dyn. Tape Max. Size: \_\_\_\_\_  
 iSCSI Target Name: \_\_\_\_\_

Connection Type: iSCSI or FC  
 iSCSI Initiator Name: \_\_\_\_\_  
 Initiator IP Address: \_\_\_\_\_

REO Device ID 62

Device Type: Disk, Tape, Dyn. Tape  
 ShareDevice: Yes or No  
 Tape Compression: Yes or No  
 Dyn. Tape Max. Size: \_\_\_\_\_  
 iSCSI Target Name: \_\_\_\_\_

Connection Type: iSCSI or FC  
 iSCSI Initiator Name: \_\_\_\_\_  
 Initiator IP Address: \_\_\_\_\_

REO Device ID 63

Device Type: Disk, Tape, Dyn. Tape  
 ShareDevice: Yes or No  
 Tape Compression: Yes or No  
 Dyn. Tape Max. Size: \_\_\_\_\_  
 iSCSI Target Name: \_\_\_\_\_

Connection Type: iSCSI or FC  
 iSCSI Initiator Name: \_\_\_\_\_  
 Initiator IP Address: \_\_\_\_\_

*External Device Configuration Page*

REO Device ID 160

iSCSI Target Name: \_\_\_\_\_

iSCSI Initiator Name: \_\_\_\_\_

Initiator IP Address: \_\_\_\_\_

REO Device ID 161

iSCSI Target Name: \_\_\_\_\_

iSCSI Initiator Name: \_\_\_\_\_

Initiator IP Address: \_\_\_\_\_

REO Device ID 162

iSCSI Target Name: \_\_\_\_\_

iSCSI Initiator Name: \_\_\_\_\_

Initiator IP Address: \_\_\_\_\_

REO Device ID 163

iSCSI Target Name: \_\_\_\_\_

iSCSI Initiator Name: \_\_\_\_\_

Initiator IP Address: \_\_\_\_\_

REO Device ID 164

iSCSI Target Name: \_\_\_\_\_

iSCSI Initiator Name: \_\_\_\_\_

Initiator IP Address: \_\_\_\_\_

REO Device ID 165

iSCSI Target Name: \_\_\_\_\_

iSCSI Initiator Name: \_\_\_\_\_

Initiator IP Address: \_\_\_\_\_

REO Device ID 166

iSCSI Target Name: \_\_\_\_\_

iSCSI Initiator Name: \_\_\_\_\_

Initiator IP Address: \_\_\_\_\_

REO Device ID 167

iSCSI Target Name: \_\_\_\_\_

iSCSI Initiator Name: \_\_\_\_\_

Initiator IP Address: \_\_\_\_\_

REO Device ID 168

iSCSI Target Name: \_\_\_\_\_

iSCSI Initiator Name: \_\_\_\_\_

Initiator IP Address: \_\_\_\_\_

REO Device ID 169

iSCSI Target Name: \_\_\_\_\_

iSCSI Initiator Name: \_\_\_\_\_

Initiator IP Address: \_\_\_\_\_

REO Device ID 170

iSCSI Target Name: \_\_\_\_\_

iSCSI Initiator Name: \_\_\_\_\_

Initiator IP Address: \_\_\_\_\_

REO Device ID 171

iSCSI Target Name: \_\_\_\_\_

iSCSI Initiator Name: \_\_\_\_\_

Initiator IP Address: \_\_\_\_\_

REO Device ID 172

iSCSI Target Name: \_\_\_\_\_

iSCSI Initiator Name: \_\_\_\_\_

Initiator IP Address: \_\_\_\_\_

REO Device ID 173

iSCSI Target Name: \_\_\_\_\_

iSCSI Initiator Name: \_\_\_\_\_

Initiator IP Address: \_\_\_\_\_

REO Device ID 174

iSCSI Target Name: \_\_\_\_\_

iSCSI Initiator Name: \_\_\_\_\_

Initiator IP Address: \_\_\_\_\_

*External Device Configuration Page (continued)*

REO Device ID 175

iSCSI Target Name: \_\_\_\_\_

iSCSI Initiator Name: \_\_\_\_\_

Initiator IP Address: \_\_\_\_\_

REO Device ID 176

iSCSI Target Name: \_\_\_\_\_

iSCSI Initiator Name: \_\_\_\_\_

Initiator IP Address: \_\_\_\_\_

REO Device ID 177

iSCSI Target Name: \_\_\_\_\_

iSCSI Initiator Name: \_\_\_\_\_

Initiator IP Address: \_\_\_\_\_

REO Device ID 178

iSCSI Target Name: \_\_\_\_\_

iSCSI Initiator Name: \_\_\_\_\_

Initiator IP Address: \_\_\_\_\_

REO Device ID 179

iSCSI Target Name: \_\_\_\_\_

iSCSI Initiator Name: \_\_\_\_\_

Initiator IP Address: \_\_\_\_\_

REO Device ID 180

iSCSI Target Name: \_\_\_\_\_

iSCSI Initiator Name: \_\_\_\_\_

Initiator IP Address: \_\_\_\_\_

REO Device ID 181

iSCSI Target Name: \_\_\_\_\_

iSCSI Initiator Name: \_\_\_\_\_

Initiator IP Address: \_\_\_\_\_

REO Device ID 182

iSCSI Target Name: \_\_\_\_\_

iSCSI Initiator Name: \_\_\_\_\_

Initiator IP Address: \_\_\_\_\_

REO Device ID 183

iSCSI Target Name: \_\_\_\_\_

iSCSI Initiator Name: \_\_\_\_\_

Initiator IP Address: \_\_\_\_\_

REO Device ID 184

iSCSI Target Name: \_\_\_\_\_

iSCSI Initiator Name: \_\_\_\_\_

Initiator IP Address: \_\_\_\_\_

REO Device ID 185

iSCSI Target Name: \_\_\_\_\_

iSCSI Initiator Name: \_\_\_\_\_

Initiator IP Address: \_\_\_\_\_

REO Device ID 186

iSCSI Target Name: \_\_\_\_\_

iSCSI Initiator Name: \_\_\_\_\_

Initiator IP Address: \_\_\_\_\_

REO Device ID 187

iSCSI Target Name: \_\_\_\_\_

iSCSI Initiator Name: \_\_\_\_\_

Initiator IP Address: \_\_\_\_\_

REO Device ID 188

iSCSI Target Name: \_\_\_\_\_

iSCSI Initiator Name: \_\_\_\_\_

Initiator IP Address: \_\_\_\_\_

REO Device ID 189

iSCSI Target Name: \_\_\_\_\_

iSCSI Initiator Name: \_\_\_\_\_

Initiator IP Address: \_\_\_\_\_

## Verifying that the Gateway Address and Management Port are Correctly Configured

The Default Gateway is the IP address that provides entrance into the network to which the REO Appliance is assigned. The Management Port connects the REO Appliance to the management system, which you use for network management on the LAN.

---

**Important:** Remember that the Management Port and both Data Ports must be on separate subnets.

---

- 1 Using the management system, access the mapped drive **\\REO\programs**.

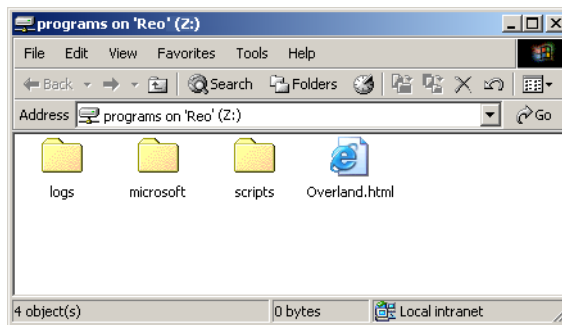

- 2 To open the REO Appliance console in your Web browser, double-click the **Overland.html** file.

**Tip:** After you have initially configured your REO Appliance, if you are not using DHCP, you can also access the interface by typing the IP address assigned to the Management Port for the REO Appliance.

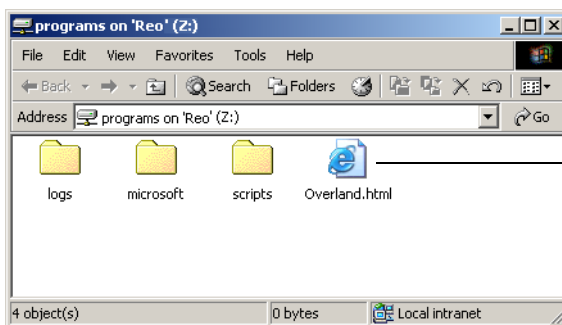

3 If you are prompted for your name and password, enter the following in case-sensitive format:

Logon Name: Administrator  
 Password: system

The REO Appliance console appears.

Tip: To access online help on any of the pages in the console, click Help under System Menu or click the Help button that appears on each of the pages.

REO Name: REO

REO Device Summary

REO Device ID	iSCSI Target Name	FC LUN	Status	Device Type	Size (GB)
0	idevice.name0	0	Up	Disk	399
1	idevice.name1	1	Up	Disk	399
2	idevice.name2	2	Up	Disk	399
3	idevice.name3	3	Up	Disk	399
4	idevice.name4	4	Up	Disk	399
5	idevice.name5	5	Up	Disk	399
6	idevice.name6	6	Up	Disk	399
7	idevice.name7	7	Up	Disk	399
8	idevice.name8	8	Up	Disk	399
9	idevice.name9	9	Up	Disk	399
10	idevice.name10	10	Up	Disk	399
11	idevice.name11	11	Up	Disk	399
12	idevice.name12	12	Up	Disk	399
13	idevice.name13	13	Up	Disk	399
14	idevice.name14	14	Up	Disk	399
15	idevice.name15	15	Up	Disk	399
16	idevice.name16	16	Up	Disk	399
17	idevice.name17	17	Up	Disk	399
18	idevice.name18	18	Up	Disk	399
19	idevice.name19	19	Up	Disk	399
20	idevice.name20	20	Up	Disk	399
21	idevice.name21	21	Up	Disk	399
22	idevice.name22	22	Up	Disk	399
23	idevice.name23	23	Up	Disk	399

© 2003-2004 Overland Storage, Inc.

If compression is enabled, Type appears in italics. If ShareDevice is enabled, Disk appears in italics. If status appears in any other color than green, see the physical management page!

To access help at any time, click Help.

- 4 In the left pane, under **System Menu**, click **Network Configuration**.

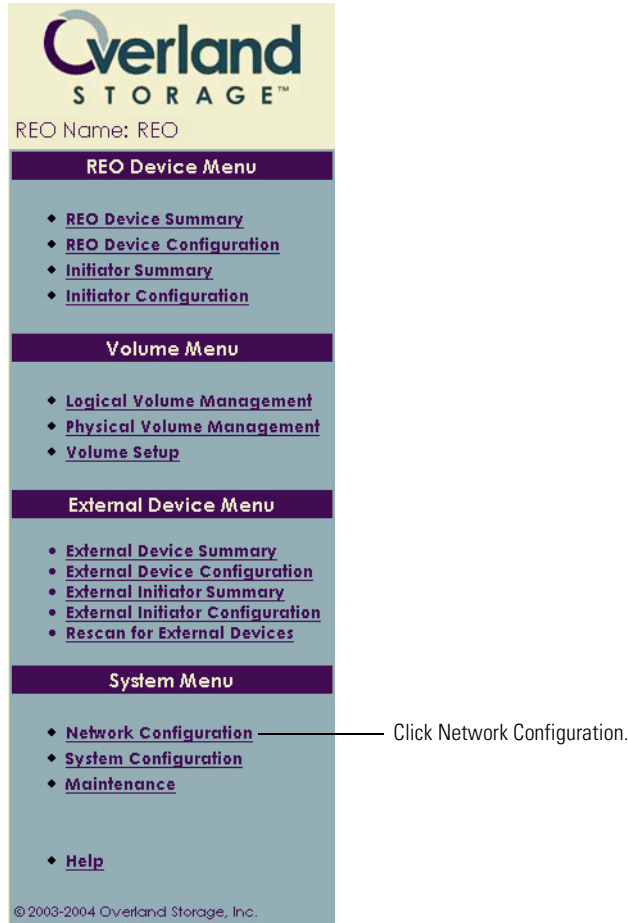

- 5 If you are *not* using DHCP, in the **Default Gateway** section of the right pane, make sure that the correct **IP Address** appears.

If DHCP is disabled, the IP address and other information is completed using information from the configuration file that you previously modified (for more information, see *Editing the Configuration File (for a non-DHCP or UNIX Management System)* on page 33).

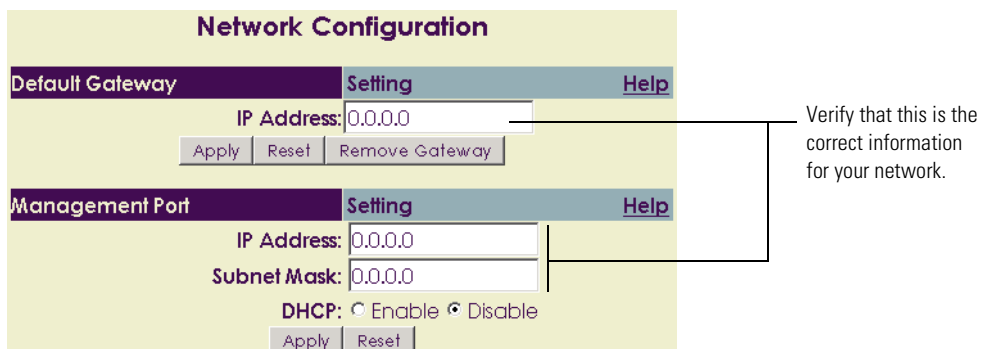

- 6 In the **Management Port** section, verify the following:
  - If your network uses DHCP (recommended), make sure that **Enable** is selected. The Management Port is automatically configured when DHCP is enabled. This is the default setting. (If you are using DHCP, the system displays the addresses that are currently being used.)
  - If your network does *not* use DHCP or you are using a UNIX-based system, make sure that the correct addresses appear and that **Disable** is selected.
- 7 Continue the configuration process by configuring the GbE data ports as described in the next section.

## Configuring the GbE Data Ports

The GbE data ports are used for block-level data transport between your backup servers and the REO Appliance. Data Port 1 and Data Port 2 are fully interchangeable prior to configuration.

---

**Important:** Remember that the Management Port is on the LAN (a 10/100 network); use Data Port 1 and Data Port 2 on separate subnets of the backup network. Data Port 1 and Data Port 2 each require an available static IP address within their respective subnets. If you want to manage the REO Appliance from the same port, use the GbE (Data Port 1 or 2) IP address. Entering this IP address in your browser displays the REO Appliance software console.

---

If you have one or two backup servers, you can connect each one directly to one of the data ports on the REO Appliance. The backup servers must have a GbE port. If you have more than two backup servers, you must make these connections through a GbE switch.

### To configure the GbE ports

- 1 In the right pane, scroll down below the **Management Port** section to locate the **Data Port 1** and **Data Port 2** sections.
- 2 In the **Data Port 1** section, enter the following:
  - **IP Address.** Using dotted decimal notation, enter an available static IP address that falls within the Data Port 1 subnet. An example of an address is: 192.168.1.4.
  - **Subnet Mask.** Using dotted decimal notation, enter the subnet address. An example of an address is: 255.255.0.0.

**Tip:** If you change one of these settings, such as the IP Address, you might need to reconnect to the server via your Web browser.

Data Port 1	Setting	Help
IP Address:	192.168.1.4	
Subnet Mask:	255.255.0.0	
<input type="button" value="Apply"/> <input type="button" value="Reset"/> <input type="button" value="Disable Port"/>		
Data Port 2	Setting	Help
IP Address:	0.0.0.0	
Subnet Mask:	0.0.0.0	
<input type="button" value="Apply"/> <input type="button" value="Reset"/>		

- 3 Click **Apply**.
- 4 Repeat these steps for **Data Port 2** using an IP address that falls within the Data Port 2 subnet.
 

Tip: Overland Storage recommends that you use a ping command to ensure that the management system sees each port on the REO Appliance.
- 5 If you purchased the FC-enabled REO Appliance, continue the configuration process by entering the FC information described in the next section; otherwise, proceed to the subsequent section, *Entering the System Information* on page 57.

## Entering the Fibre Channel Information

- 1 In the right pane, scroll down to the **Fibre Channel Configuration** section.
- 2 For each FC port (the REO Appliance provides two), select the applicable settings from the **Set Link Speed** and **Set Link Topology** lists.
  - For link speed, select **Auto**, **1 GB**, or **2 GB**.
  - For topology, select **Auto**, **Fabric/Point-to-Point (N\_Port)**, or **Loop (NL\_Port)**.

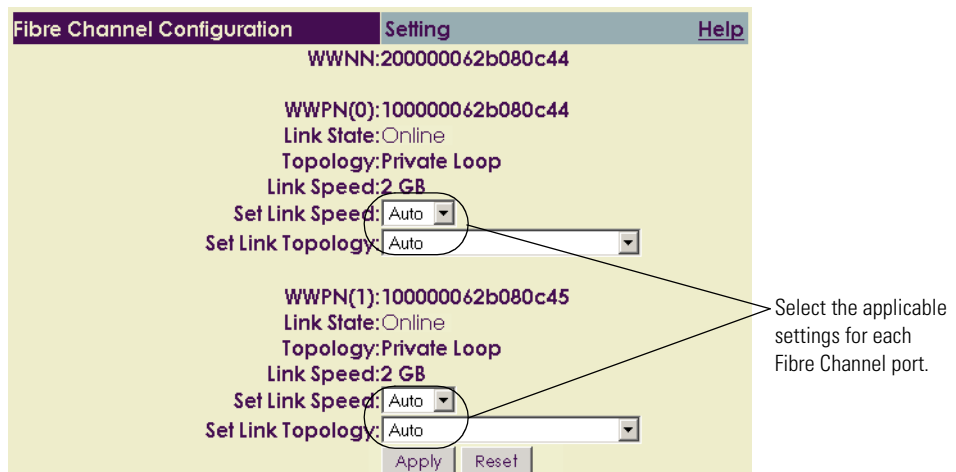

- 3 Click **Apply**.
- 4 Continue the configuration process by configuring the system information as described in the next section.



## Entering the System Information

- 1 In the left pane, under **System Menu**, click **System Configuration**.

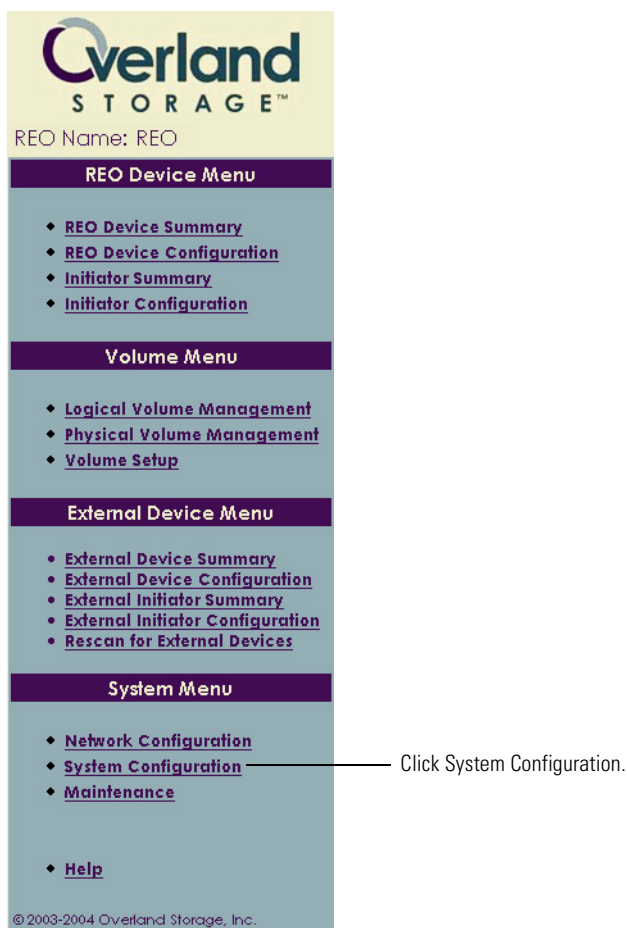

- 2 In the **System Information** section of the right pane, enter the following:
  - **Workgroup/Domain Name.** Enter the workgroup or domain name assigned by your network administrator.
  - **REO Name.** Enter up to 16 characters to name the REO Appliance. You can use letters or a mixture of letters and numbers, and you can also use hyphens (-). Overland Storage recommends that you change this name (the default is REO), especially if you use multiple REO Appliances in your network.
  - **REO Description.** Enter up to 20 alphabetical or numerical characters (or a combination of the two) to describe the appliance.

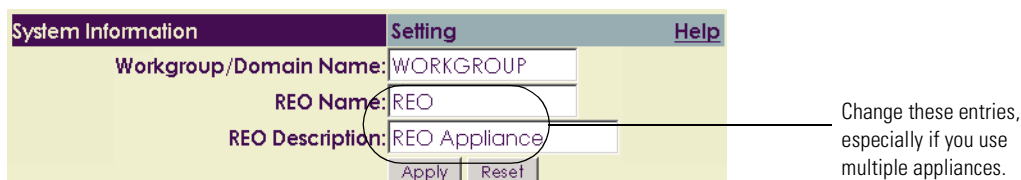

- 3 Click **Apply**.
- 4 Continue the configuration process by entering the logon information described in the next section.

## Configuring Logon Information

Using the Logon Information section, you can change your logon name and password, which Overland Storage recommends that you do during the initial configuration process. If you choose to keep Administrator as your logon name, Overland Storage strongly recommends that you change the password to protect your network from unauthorized users.

- 1 In the right pane, scroll down below the **System Information** section to locate the **Logon Information** section, and enter the following *in case-sensitive format*:
  - **User Name.** (required) Enter a new logon name using up to 30 alphabetical or numerical characters or a combination of the two.
  - **Password.** (optional) Enter a new password using up to 30 alphabetical or numerical characters or a combination of the two characters (do not use spaces or Ctrl-key characters).
  - **Retype Password.** Enter the password again.

- 2 Click **Apply**.
- 3 Continue the configuration process by entering the e-mail information described in the next section.

## Configuring E-mail Alerts

The REO Appliance continuously monitors its performance and routinely checks for disk failures. If you use the messaging option, an e-mail is sent whenever the Status of a volume on the REO Device Summary page becomes anything other than Up (for example, changes to REBUILDING).

**Tip:** You can also use the ALARM MESSAGES section on the Physical Volume Management page to see more information. The messages (also known as asynchronous event notifications) that appear on this page display additional information about each disk that might not be displayed in an alert e-mail.

You can specify whether the REO Appliance should send an alert once or repeat the message until the issue is resolved. Each alert that is sent reports the status of all volumes on the REO Appliance. If you configure the option to use an Alert Frequency of five minutes or more, the alerts will be numbered.

If your mail server is able to send e-mail messages outside the company, you can also set up messaging to notify Overland Storage Technical Support automatically whenever a critical error occurs.

### To configure messaging

- 1 In the right pane, scroll down below the **Logon Information** section to locate the **E-mail Notification** section, and enter the following:
  - **Mail Address.** Using dotted decimal notation, enter the IP address of your *incoming* mail server.
  - **From Address.** Enter the e-mail address from which the alert will be sent. This address must use the same domain as the mail server specified for Mail Address.
  - **Address for all warnings & critical messages.** Enter the e-mail address to which alerts should be sent (for example, the e-mail address for the network administrator).
  - **Address for critical messages only.** To instruct the REO Appliance to notify Overland automatically whenever a critical message is presented, enter the following e-mail address:  
techsupport@overlandstorage.com
  - **Alert Frequency.** Enter a value of 5 or higher to specify how often (in minutes) the REO Appliance should send messages. To send only one message per error, enter 0.

E-mail Notification	Setting	<a href="#">Help</a>
Mail Address:	<input type="text" value="0.0.0.0"/>	
From Address:	<input type="text" value="From@my-domain.com"/>	
Address for all warnings & critical messages:	<input type="text" value="To@my-domain.com"/>	
Address for critical messages only: (Overland Notification)	<input type="text"/>	
Alert Frequency:	<input type="text" value="60"/> minutes	
	<input type="button" value="Apply"/> <input type="button" value="Reset"/> <input type="button" value="Test"/>	

- 2 To verify that the messaging system is configured correctly, click **Test**. If the test e-mail message is not successfully sent and received, correct the applicable information, and repeat the test.
- 3 Click **Apply**.

## Setting the Time and Date Information

The REO Appliance is originally set to use the time that corresponds to the Pacific time zone. If you are setting up the REO Appliance in a different time zone, you need to update the time and date settings accordingly. This ensures that any communication that occurs (for example, if an e-mail is automatically generated) reflects the correct date and time.

- 1 In the right pane, scroll down below the **E-mail Notification** section to locate the **Set Time** section.
- 2 Select the applicable settings, and click **Submit**.

**Set Time** [Help](#)

Current Time: 02:29 PM

Hours: 02 Minutes: 29 AM/PM: PM

Current Date: Tuesday September 07 2004

Month: September Day: 07 Year: 2004

Submit Reset

- 3 After you complete these configuration steps for the management system, proceed to the configuration steps outlined in *Configuring the Systems Involved in the Backup Process* on page 61.



# 5 | Configuring the Systems Involved in the Backup Process

CHAPTER

The main steps involved in configuring the backup servers include:

- Step 1** Mapping the REO Appliance to a drive letter to simplify access to the console and other installation and management tools.
- Step 2** Installing software client drivers or storage adapters for iSCSI or FC access.

## Mapping a Network Drive to the REO Appliance (Windows Only)

To access the components used for installation and configuration of the REO Appliance, you must map a network drive from the system to a folder located on the REO Appliance.

- 1 Make sure that the REO Appliance is still powered on and that the REO SoftKey is still inserted in a USB port.
- 2 Perform the steps previously outlined under *Mapping a Network Drive to the REO Appliance (Windows Only)* on page 39.
- 3 Repeat these steps for *each* system that will access storage on the REO Appliance.

## Establishing Communication

If you are using iSCSI connectivity, iSCSI initiators are required to communicate with the iSCSI targets (REO Devices) on the REO Appliance. Each backup server that uses the REO Appliance must be equipped with a software initiator, such as the Microsoft iSCSI Software Initiator, or an IP storage HBA, such as the Intel PRO/1000 T IP Storage Adapter.

**Note:** You do not need TOE-equipped (Transmission Control Protocol [TCP] Offload Engine) or special iSCSI-capable GbE HBAs to work with software initiators. Any standard Network Interface Card (NIC) can serve as an iSCSI network interface device; however, Overland Storage strongly recommends that you use GbE for enhanced performance.

If you are using FC connectivity, make sure that the applicable FC initiator is installed.

### To establish communication

- 1 Install the desired software initiator or storage adapter.  
**Note:** For detailed information on various drivers and adapters, see the manufacturer's documentation for assistance on assigning targets (REO Devices). You can also check the Overland Web site ([www.overlandstorage.com](http://www.overlandstorage.com)) for the applicable Application Notes.
- 2 Repeat these steps for *each* system that will access storage on the REO Appliance.
- 3 After you complete these configuration steps, choose one of the following:
  - If you want to use the default volume configuration of RAID 5 with logical volumes, proceed to the steps outlined in *Creating Logical Volumes* on page 71.
  - If you want to use a different configuration, proceed to the steps outlined in *Changing the Volume Configuration* on page 63.



# 6 | Changing the Volume Setup or Creating Logical Volumes

CHAPTER

The main steps involved in switching from one configuration to another or creating logical volumes include:

- Step 1** Selecting the applicable configuration.
- Step 2** Creating the desired number of logical volumes, and setting their size.

## Using the Default Volume Setup

The REO Appliance uses a default volume configuration of RAID 5 with logical volumes. To use this configuration, you must create the logical volumes.

- To use the default configuration and create logical volumes, proceed to *Creating Logical Volumes* on page 71.

## Changing the Volume Configuration

You can use the Volume Setup feature in the console to select a different RAID configuration or to select the JBOD configuration.

---

**Important:** Be aware that the process of changing the volume configuration takes time for the RAID 5 configurations while the arrays are initialized. After you select the new configuration and the initialization process begins, you can use the REO Appliance, but performance will be impacted. Overland Storage strongly recommends that you wait until the Status on the Physical Volume Management page is OK (not INITIALIZING) before using a volume. (Switching to a RAID 0 or JBOD configuration usually requires less than 10 minutes.)

---

## Selecting JBOD

- 1 In the left pane, under **Volume Menu**, click **Volume Setup**.

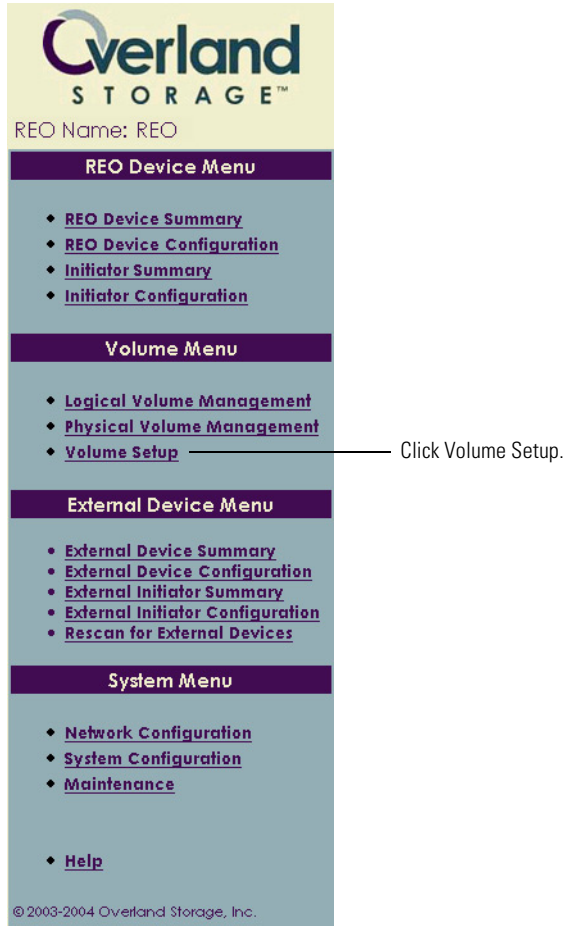

- 2 In the **Select Physical Configuration** list, select **JBOD only**, and click **Submit**.

The screenshot shows the "Volume Setup" page. At the top, the title "Volume Setup" is displayed. Below the title, there is a "Select Physical Configuration" section with a "Help" link. The section contains a list of radio button options with their descriptions:

- JBOD only: Creates volumes for the best performance (without redundancy)
- RAID 0 only: Creates striped volumes for enhanced performance (without redundancy)
- RAID 5 only: Creates volumes that use striping and distributed parity to provide a balance between performance and availability
- RAID 0 & Logical Volumes: Creates logical volumes from the storage pool produced from RAID 0 volumes
- RAID 5 & Logical Volumes: Creates logical volumes from the storage pool produced from RAID 5 volumes

At the bottom of the page, there is a "Submit" button.



- 3 When the warning message appears that indicates all data currently residing on the REO Appliance will be deleted, click **OK** to continue.

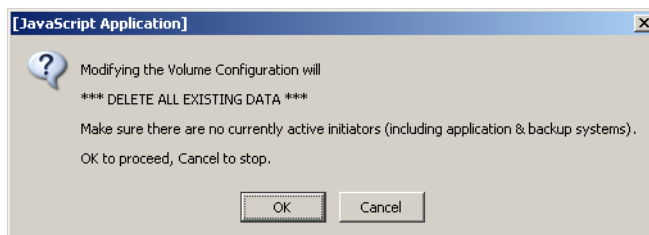

- 4 When the message appears that indicates the REO Appliance must be restarted, click **OK** to continue.

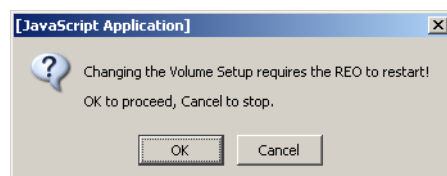

- 5 After waiting approximately five minutes, log on to the console, and then proceed to the steps outlined in *Configuring REO Devices as Disk or Tape Devices* on page 73.

## Selecting a RAID Configuration

The REO Appliance supports RAID 0 and RAID 5. You can only select one configuration; that is you cannot set up one volume to use RAID 0 and set up another to use RAID 5.

---

**Important:** Because the process of changing the volume configuration takes time if you select a RAID 5 option, Overland Storage recommends that you make your selection and let the process run overnight. (Switching to a RAID 0 or JBOD configuration usually requires less than 10 minutes.)

---

In a RAID configuration, how the volumes are arranged depends on whether you are using an appliance that contains 12 physical disks or 24, and it depends on whether those disks are 250 GB or 400 GB in size.

The appliance also contains two physical hosts (controllers). If you are using 12 physical disks, they are all assigned to the first host; if you are using 24 disks, the second set of disks is assigned to the second host.

If you select a RAID 5 option, you will also have the option of creating a hot-spare disk drive for each physical host (controller) after you click Submit. (These disk drives remain in standby mode, so that you can use them immediately if another disk fails.)

The following describes how the volumes are arranged in RAID configurations, depending on the number of disks and their size.

If you are using the 12-disk appliance:

- **RAID 0.** Creates three REO Devices. Each REO Device (physical unit [PU]) is comprised of four disks. Each device provides either 1000 GB (using 250 GB disks) or 1600 GB (using 400 GB disks) of capacity.
- **RAID 5, without hot spare.** Creates two REO Devices. Each REO Device (PU) is comprised of six disks. Each device provides either 1250 GB (using 250 GB disks) or 2000 GB (using 400 GB disks) of capacity.
- **RAID 5, with hot spare.** Creates two REO Devices and one hot-spare disk. One REO Device (PU) is comprised of six disks and the other is comprised of five disks. The five-disk device provides either 1000 GB (using 250 GB disks) or 1600 GB (using 400 GB disks) of capacity, and the six-disk device provides either 1250 GB (using 250 GB disks) or 2000 GB (using 400 GB disks) of capacity.

If you are using the 24-disk appliance:

- **RAID 0.** Creates six REO Devices (three physical units for each host). Each REO Device (PU) is comprised of four disks. Each device provides either 1000 GB (using 250 GB disks) or 1600 GB (using 400 GB disks) of capacity.
- **RAID 5, without hot spare.** Creates four REO Devices (two physical units for each host). Each REO Device (PU) is comprised of six disks. Each device provides either 1250 GB (using 250 GB disks) or 2000 GB (using 400 GB disks) of capacity.
- **RAID 5, with hot spare.** Creates four REO Devices (two physical units for each host) and one hot-spare disk for each host. One REO Device (PU) for each host is comprised of six disks and the other device for each host is comprised of five disks. The five-disk device provides either 1000 GB (using 250 GB disks) or 1600 GB (using 400 GB disks) of capacity, and the six-disk device provides either 1250 GB (using 250 GB disks) or 2000 GB (using 400 GB disks) of capacity.

## To change the RAID configuration

- 1 In the left pane, under **Volume Menu**, click **Volume Setup**.

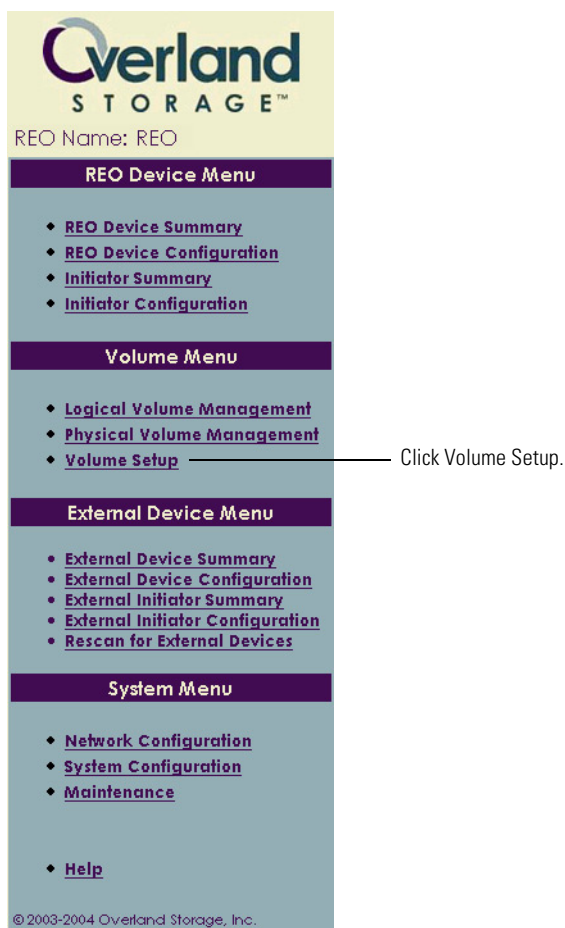

- 2 In the list of volume configurations on the right, select the desired RAID configuration, and then click **Submit**.

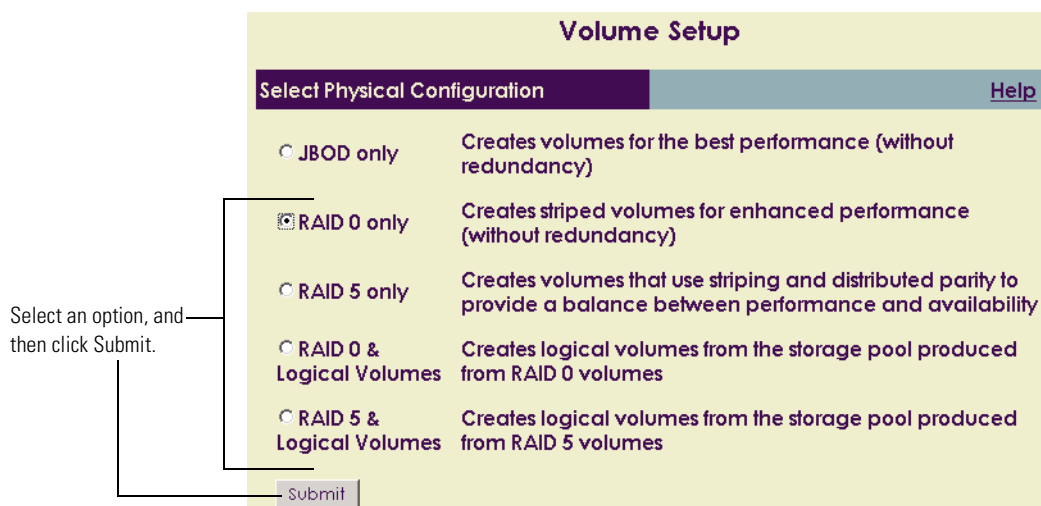

- 3 If you selected a RAID 5 option and you want to create a hot spare for each host (controller), click **OK** when the following message appears; otherwise, click **Cancel**.

Clicking Cancel does not prevent you from continuing with setting up a RAID 5 configuration; it instructs the appliance to skip the step of creating a hot spare.

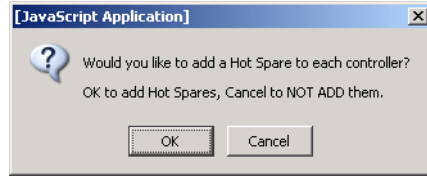

- 4 When the warning message appears that indicates all data currently residing on the REO Appliance will be deleted, click **OK** to continue.

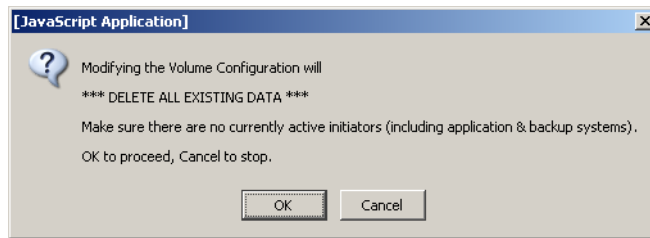

- 5 When the message appears that indicates the REO Appliance must be restarted, click **OK** to continue.

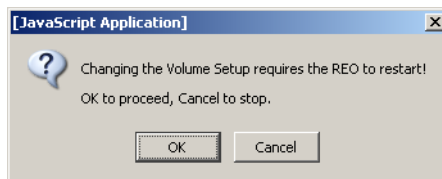

- 6 After waiting approximately five minutes, log on to the console.

- 7 To view the volumes created for the configuration and their status, under **Volume Menu** in the left pane, click **Physical Volume Management**.

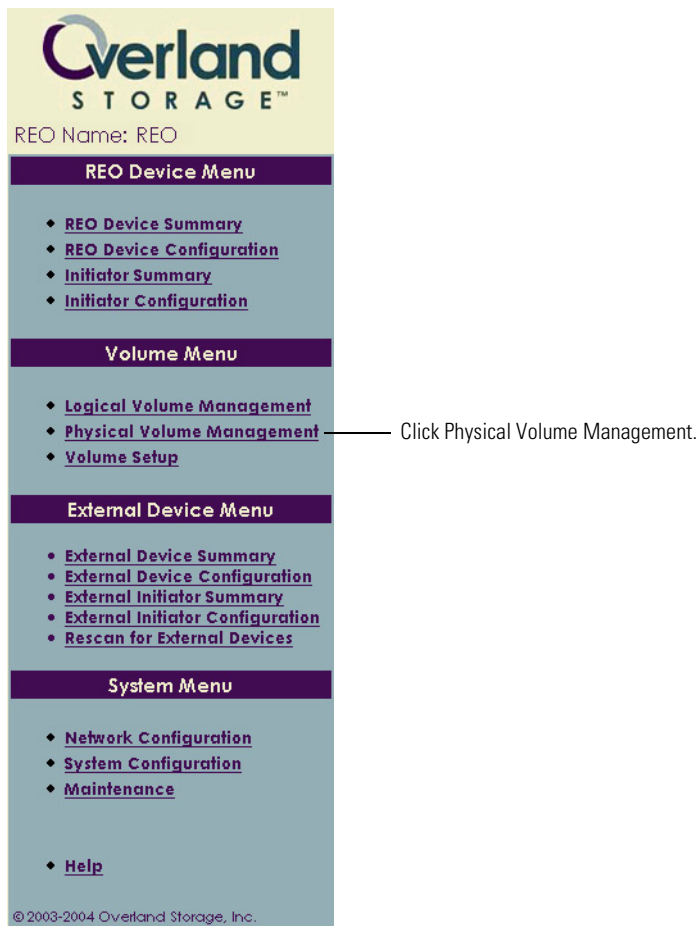

When you first create a new RAID 5 configuration, the Status for each physical unit (PU) is INITIALIZING. After the initial build phase completes (this can take a while, depending on the number of units and the size of each; to display the current percentage complete, click the Physical Volume Management option again), the Status changes to OK. While the volumes are in an initializing state, they are *not* redundant.

**Note:** Although the volumes are available while they are in an initializing state, performance is impacted. Overland Storage strongly recommends that you wait until the Status is OK before using a volume.

### Physical Volume Management

**WARNING:** Do NOT remove a disk drive without first clicking the applicable Remove button below.

[Help](#)

#### Host: 1 Information

**RAID5:PU:00 - SCSI ID: 0 Size: 1999 GB**

Status: **INITIALIZING (3%)**

- Disk: 0 Status: OK
- Disk: 1 Status: OK
- Disk: 2 Status: OK
- Disk: 3 Status: OK
- Disk: 4 Status: OK
- Disk: 5 Status: OK

**RAID5:PU:01 - SCSI ID: 1 Size: 1999 GB**

Status: **INITIALIZING (3%)**

- Disk: 6 Status: OK
- Disk: 7 Status: OK
- Disk: 8 Status: OK
- Disk: 9 Status: OK
- Disk: 10 Status: OK
- Disk: 11 Status: OK

**FREE DRIVE POOL - SCSI ID: 99 Size: 0 GB**

Status: **EMPTY**

#### ALARM MESSAGES:

#### Host: 2 Information

**RAID5:PU:12 - SCSI ID: 0 Size: 1999 GB**

Status: **INITIALIZING (3%)**

- Disk: 12 Status: OK
- Disk: 13 Status: OK
- Disk: 14 Status: OK
- Disk: 15 Status: OK
- Disk: 16 Status: OK
- Disk: 17 Status: OK

**RAID5:PU:13 - SCSI ID: 1 Size: 1999 GB**

Status: **INITIALIZING (3%)**

- Disk: 18 Status: OK
- Disk: 19 Status: OK
- Disk: 20 Status: OK
- Disk: 21 Status: OK
- Disk: 22 Status: OK
- Disk: 23 Status: OK

**FREE DRIVE POOL - SCSI ID: 99 Size: 0 GB**

Status: **EMPTY**

#### ALARM MESSAGES:

After the initial build completes, this status changes to OK.

- 8 If you chose to create logical volumes, complete the steps outlined in the next section; otherwise, proceed to the steps outlined in *Configuring REO Devices as Disk or Tape Devices* on page 73.

## Creating Logical Volumes

Using this feature, you can create up to 64 LUNs (volumes) of various sizes in 1 GB increments.

- 1 On the **Logical Volume Management** page, click **Add Volume**.
- 2 In the **Volume Size** box on the **Create New Logical Volume** page, enter the size (in GB) of the first volume that you want to create, and then click **Add**.

Tip: If you intend to use the volume as a Dynamic Tape device, you can enter a 1. The information you enter later when you create the Dynamic Tape devices will override what you enter here.

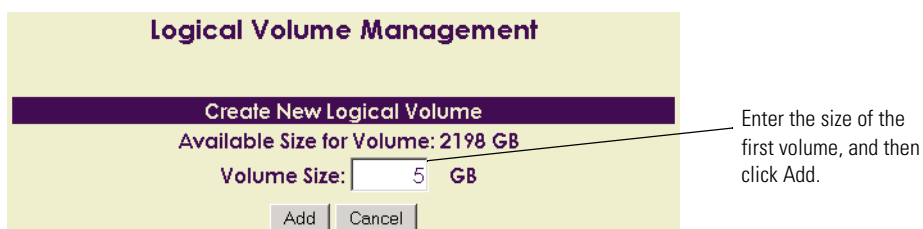

**Logical Volume Management**

Create New Logical Volume

Available Size for Volume: 2198 GB

Volume Size:  GB

Enter the size of the first volume, and then click Add.

The Logical Volume Management page reappears, with the new volume listed.

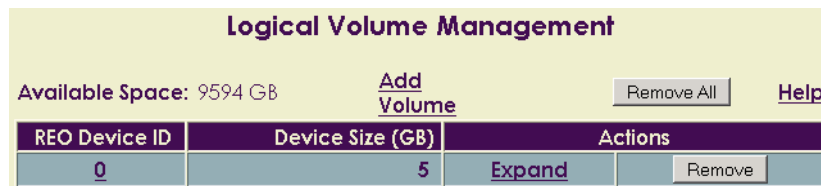

**Logical Volume Management**

Available Space: 9594 GB   [Help](#)

REO Device ID	Device Size (GB)	Actions
0	5	<input type="button" value="Expand"/> <input type="button" value="Remove"/>

After you have created a volume, you can also change its size (use the Expand button) or remove it from the list.

- 3 To create additional volumes, repeat step 1 and step 2.

Note: The maximum number of volumes you can create is 64, and the total amount of space you can use must be within the total amount of space available on the physical volumes (disk drives).

Logical Volume Management			
Available Space: 1968 GB		<a href="#">Add Volume</a>	<a href="#">Remove All</a> <a href="#">Help</a>
REO Device ID	Device Size (GB)	Actions	
<a href="#">0</a>	150	<a href="#">Expand</a>	<a href="#">Remove</a>
<a href="#">1</a>	116	<a href="#">Expand</a>	<a href="#">Remove</a>
<a href="#">2</a>	6	<a href="#">Expand</a>	<a href="#">Remove</a>
<a href="#">3</a>	50	<a href="#">Expand</a>	<a href="#">Remove</a>
<a href="#">4</a>	7	<a href="#">Expand</a>	<a href="#">Remove</a>
<a href="#">5</a>	5	<a href="#">Expand</a>	<a href="#">Remove</a>
<a href="#">6</a>	100	<a href="#">Expand</a>	<a href="#">Remove</a>
<a href="#">7</a>	5	<a href="#">Expand</a>	<a href="#">Remove</a>
<a href="#">8</a>	27	<a href="#">Expand</a>	<a href="#">Remove</a>
<a href="#">9</a>	150	<a href="#">Expand</a>	<a href="#">Remove</a>
<a href="#">10</a>	5	<a href="#">Expand</a>	<a href="#">Remove</a>
<a href="#">11</a>	125	<a href="#">Expand</a>	<a href="#">Remove</a>
<a href="#">12</a>	200	<a href="#">Expand</a>	<a href="#">Remove</a>
<a href="#">13</a>	5	<a href="#">Expand</a>	<a href="#">Remove</a>
<a href="#">14</a>	235	<a href="#">Expand</a>	<a href="#">Remove</a>
<a href="#">15</a>	5	<a href="#">Expand</a>	<a href="#">Remove</a>
<a href="#">16</a>	234	<a href="#">Expand</a>	<a href="#">Remove</a>
<a href="#">17</a>	5	<a href="#">Expand</a>	<a href="#">Remove</a>
<a href="#">18</a>	555	<a href="#">Expand</a>	<a href="#">Remove</a>
<a href="#">19</a>	5	<a href="#">Expand</a>	<a href="#">Remove</a>

- 4 After you complete these steps, proceed to the steps outlined in *Configuring REO Devices as Disk or Tape Devices* on page 73.





# 7 | Configuring REO Devices as Disk or Tape Devices

CHAPTER

You can configure *each* REO Device to function either as a disk device (the default) or as a virtual LTO-2 tape device; that is, you can use each device in its native disk format, virtual-tape format, or any combination of the two.

**Note:** To use the ShareDevice feature (available only on Windows) with a device, the device must be designated as a disk device. For more information, see *Sharing Access to a REO 9000 Between Multiple Systems* on page 115.

As explained previously, the number of devices that you have depends on the volume configuration that you use. For example, if you use logical volumes with RAID 5, you can create up to 64 disk LUNs, 64 virtual LTO-2 tape devices, or any combination of LUNs and virtual LTO-2 devices up to 64 in total.

## Using Devices as Disk Devices

- ▶ If you want each REO Device to function as a disk device (the default), proceed to the steps outlined in *Associating Targets (Devices) and Initiators* on page 87.

## Creating Tape Devices

If you intend to create devices of type Tape or Dynamic Tape, note the following:

- As with standard tape devices, a specific driver (on a Windows system) or changes to a system configuration (on a UNIX system) might be required to operate with your selected backup software. For more information, check the Overland Storage Web site ([www.overlandstorage.com](http://www.overlandstorage.com)) for Application Notes related to your specific backup software.
- If you are using logical volumes, you can create dynamic tape devices, which expand and contract to accommodate the size of a specific backup job.
- When you change the configuration of a device, *all data currently residing on the device is deleted*.

- If you chose to use a RAID configuration with logical volumes (required if you want to create devices of type Dynamic Tape), you must create the volumes before you can change the device settings. For more information, see *Creating Logical Volumes* on page 71.
- If you choose to enable compression, be aware that various factors (such as the speed of your backup server, source devices, or network) can significantly affect performance. Additionally, the existing state of the files you are backing up (for example, whether the files are already compressed) can affect the level of compression that might be achieved. Consider these factors when you determine the applicable settings for your backup environment.

## Changing a Device from Disk to Tape (Standard)

- 1 In the left pane, under **REO Device Menu**, click **REO Device Configuration**.

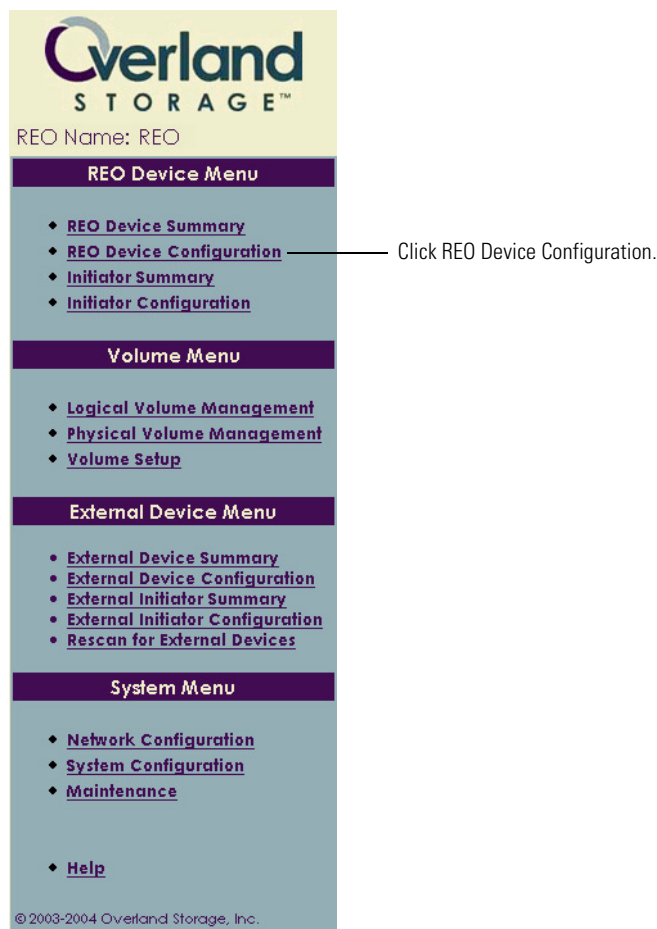

The REO Device Configuration page displays the current settings for the first device listed in the REO Device ID list.

- From the **REO Device ID** list, select the first device whose configuration you want to change.

REO Device Configuration

REO Device ID: 1

Select a device.

REO Device Information	Setting	Help
Device Type:	<input type="radio"/> Disk <input checked="" type="radio"/> Tape <input type="radio"/> Dynamic Tape	
ShareDevice:	<input type="checkbox"/>	
Enable Tape Compression:	<input type="checkbox"/>	
Dynamic Tape Max Size:	<input type="text"/>	
iSCSI Target Name:	idev1	
Size:	200	
Status:	Up	
FC LUN:	1	
WWNN:	200000062b0778e8	
WWPN(0):	100000062b0778e8	
WWPN(1):	100000062b0778e9	

Current initiator access list: None

Submit Reset Add New Initiators

- In the **Device Type** section, select **Tape**.
- If you want to maximize backup storage capacity, select the **Enable Tape Compression** check box (for optimal backup performance, leave the check box cleared).
- To change the default target name of a device, in the **iSCSI Target Name** box, type the new name (for example, LTO7).

**Important:** The target names must be unique within a network. If you are using multiple appliances, you must change the default target names. For more information, see *Expanding Storage Capacity (Scalability)* on page 107.

REO Device Configuration

REO Device ID: 7

REO Device Information	Setting	Help
Device Type:	<input type="radio"/> Disk <input checked="" type="radio"/> Tape <input type="radio"/> Dynamic Tape	
ShareDevice:	<input type="checkbox"/>	
Enable Tape Compression:	<input checked="" type="checkbox"/>	
Dynamic Tape Max Size:	<input type="text"/> GB	
iSCSI Target Name:	LTO7	
Size:	250 GB	
Status:	Up	
FC LUN:	7	
WWNN:	200000062b0778e8	
WWPN(0):	100000062b0778e8	
WWPN(1):	100000062b0778e9	

Current initiator access list: None

Submit Reset Add New Initiators

Type a new name (if desired), and then click Submit.

- To save your changes, click **Submit** (or click Reset to cancel).

- 7 When the warning message appears that indicates all data currently residing on the device will be deleted, click **OK** to continue.

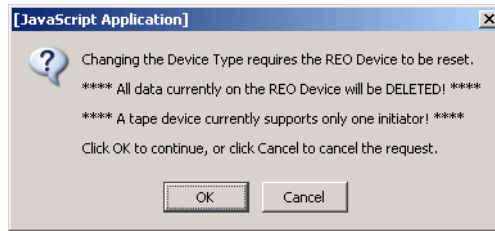

Any changes you make are also reflected on the REO Device Summary page.

REO Device Summary					Help
REO Device ID	iSCSI Target Name	FC LUN	Status	Device Type	Size (GB)
0	idevice.name0	0	Up	Disk	350
1	idevice.name1	1	Up	Disk	850
2	idevice.name2	2	Up	Disk	351
4	idevice.name4	4	Up	Disk	700
7	<i>lto7</i>	7	Up	<i>Tape</i>	250

If compression is enabled, *Tape* appears in italics. If ShareDevice is enabled, *Disk* appears in italics. If status appears in any other color than green, see the physical management page!

Changes are reflected on the summary.

- 8 If you want to create dynamic tape devices, continue to the next section; otherwise, proceed to the steps outlined in *Associating Targets (Devices) and Initiators* on page 87.

## Changing a Device from Disk to Dynamic Tape

- 1 In the left pane, under **REO Device Menu**, click **REO Device Configuration**.

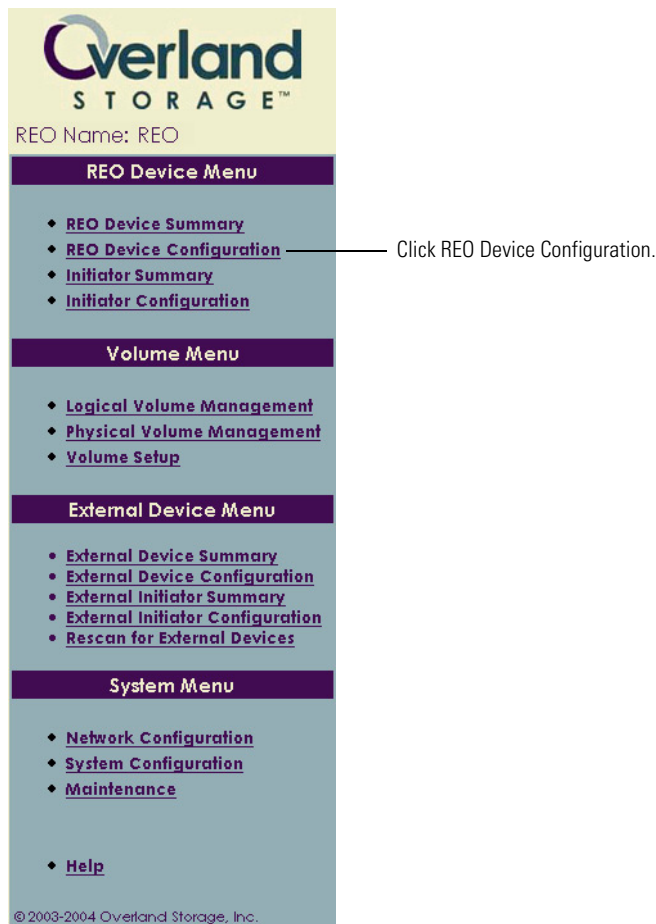

The REO Device Configuration page displays the current settings for the first device listed in the REO Device ID list.

- 2 From the **REO Device ID** list, select the first device whose configuration you want to change.

The number of device IDs listed depends on the number of volumes that you created.

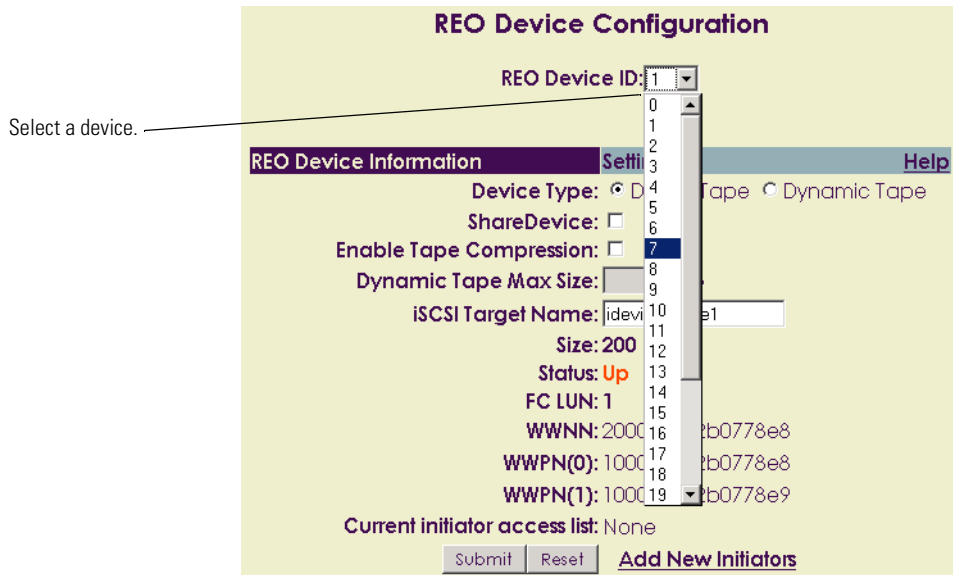

**3** In the **Device Type** section, select **Dynamic Tape**.

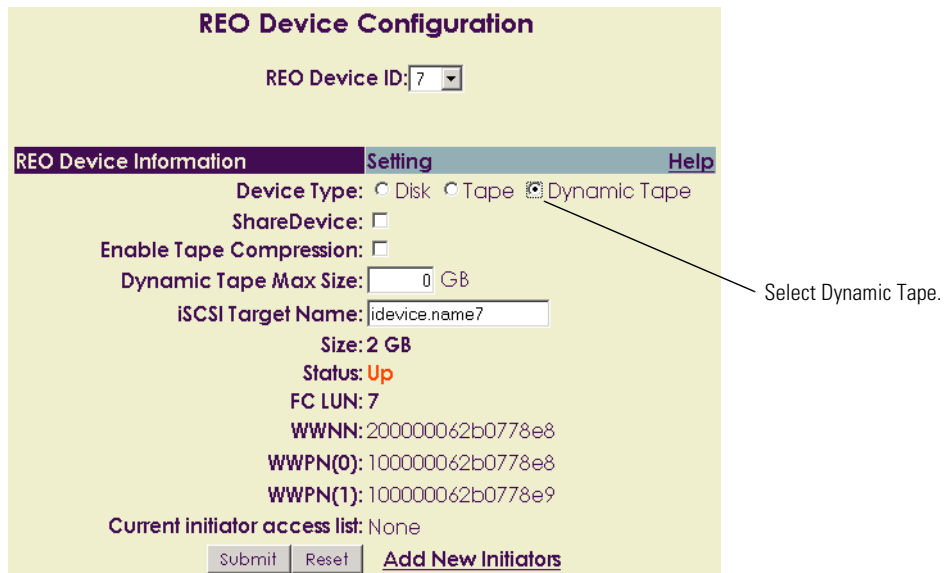

- 4** If you want to maximize backup storage capacity, select the **Enable Tape Compression** check box (for optimal backup performance, leave the check box cleared).
- 5** If you want to specify a maximum size for the tape, enter the size in the **Dynamic Tape Max Size** box.

The default is 0, which allows the appliance to use the available space on a volume, up to 2198 GB.

**Note:** If you decide to change the maximum size at a later date, be aware that you can only increase the size; you cannot reduce it. To use a device with a smaller maximum size, you must either delete this device and re-create it using the desired size, or create an additional device that uses the desired size.

- 6 To change the default target name of a device, in the **iSCSI Target Name** box, type the new name (for example, LTO7).

**Important:** The target names must be unique within a network. If you are using multiple appliances, you must change the default target names. For more information, see *Expanding Storage Capacity (Scalability)* on page 107.

REO Device ID: 7

REO Device Information	Setting	Help
Device Type:	<input type="radio"/> Disk <input type="radio"/> Tape <input checked="" type="radio"/> Dynamic Tape	
Share Device:	<input type="checkbox"/>	
Enable Tape Compression:	<input type="checkbox"/>	
Dynamic Tape Max Size:	<input type="text" value="0"/> GB	
iSCSI Target Name:	<input type="text" value="dynTapeLTO7"/>	
Size:	2 GB	
Status:	Up	
FC LUN:	7	
WWNN:	200000062b0778e8	
WWPN(0):	100000062b0778e8	
WWPN(1):	100000062b0778e9	
Current initiator access list:	None	
<input type="button" value="Submit"/> <input type="button" value="Reset"/> <a href="#">Add New Initiators</a>		

Type a new name (if desired), and then click Submit.

- 7 To save your changes, click **Submit**.
- 8 When the warning message appears that indicates all data currently residing on the device will be deleted, click **OK** to continue.

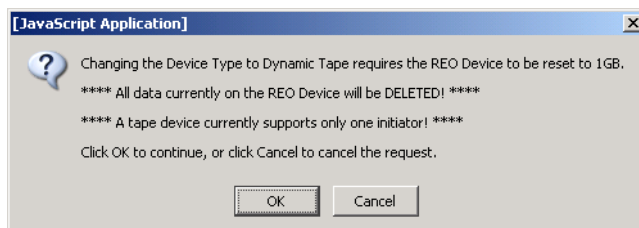

After the change is processed, the REO Device Configuration page reappears and displays the serial number assigned to the device. You can use this serial number to identify the device in your backup software.

REO Device ID: 7

REO Device Information	Setting	Help
Device Type:	<input type="radio"/> Disk <input type="radio"/> Tape <input checked="" type="radio"/> Dynamic Tape	
ShareDevice:	<input type="checkbox"/>	
Enable Tape Compression:	<input type="checkbox"/>	
Dynamic Tape Max Size:	0 GB	
iSCSI Target Name:	dyntapelto7	
Size:	1 GB	
Status:	Up	
Tape Serial#:	812933B207	
FC LUN:	7	
WWNN:	200000062b0778e8	
WWPN(0):	100000062b0778e8	
WWPN(1):	100000062b0778e9	
Current initiator access list:	None	
<input type="button" value="Submit"/> <input type="button" value="Reset"/> <a href="#">Add New Initiators</a>		

This identifies the serial number assigned to the device.

Any changes you make are also reflected on the REO Device Summary page.

REO Device Summary

REO Device ID	iSCSI Target Name	FC LUN	Status	Device Type	Size (GB)	Help
0	idevice.name0	0	Up	Disk	110	
1	idevice.name1	1	Up	Disk	200	
2	idevice.name2	2	Up	Disk	10	
3	idevice.name3	3	Up	Disk	10	
4	idevice.name4	4	Up	Disk	10	
5	idevice.name5	5	Up	Disk	150	
6	idevice.name6	6	Up	Disk	300	
7	dyntapelto7	7	Up	Dynamic Tape	1	
8	idevice.name8	8	Up	Disk	1	
9	idevice.name9	9	Up	Disk	1	
10	idevice.name10	10	Up	Disk	5	
11	idevice.name11	11	Up	Disk	5	
12	idevice.name12	12	Up	Disk	1	
13	idevice.name13	13	Up	Disk	1	
14	idevice.name14	14	Up	Disk	1	
15	idevice.name15	15	Up	Disk	1	
16	idevice.name16	16	Up	Disk	1	
17	idevice.name17	17	Up	Disk	1	
18	idevice.name18	18	Up	Disk	1	
19	idevice.name19	19	Up	Disk	1	
20	idevice.name20	20	Up	Disk	1	
21	idevice.name21	21	Up	Disk	1	
22	idevice.name22	22	Up	Disk	1	
23	idevice.name23	23	Up	Disk	1	
24	idevice.name24	24	Up	Disk	1	
25	idevice.name25	25	Up	Disk	1	
26	idevice.name26	26	Up	Disk	1	

Changes are reflected on the summary.

If compression is enabled, Tape appears in italics. If ShareDevice is enabled, Disk appears in italics. If status appears in any other color than green, see the physical management page!

9 After you complete these steps, proceed to the steps outlined in *Associating Targets (Devices) and Initiators* on page 87.





# 8 | Configuring External (SCSI) Devices

---

CHAPTER

The SCSI ports on the REO Appliance let you attach external devices (such as tape drives or changers) and then use the console to assign initiators. The appliance provides two SCSI ports, and you can use a chain formation to assign up to 15 SCSI IDs to each port (the SCSI IDs must be unique within each port configuration).

---

**Important:** For a list of supported SCSI devices (some device-types and configurations are not currently supported), see the REO Interoperability Matrix on the Overland Storage Web site at [www.overlandstorage.com](http://www.overlandstorage.com).

---

## Detecting External Devices

When you enable power to the REO Appliance, it automatically detects whether External Devices are attached to the SCSI ports and displays the applicable information in the External Device Summary and External Device Configuration pages.

If you turn off or detach an External Device while the REO Appliance is running, the External Device remains in the list of REO Device IDs, but the Device Type and SCSI Port:ID are set to None and the Inquiry

Information is set to No Device Found. (The items remain in the External Device Summary and the External Initiator Summary, even if you power down and restart the REO Appliance.)

External Device Summary				
				<a href="#">Help</a>
REO Device ID	iSCSI Target Name	Device Type	SCSI Port : ID	Inquiry Information
<a href="#">160</a>	idevice.name160	Tape	0 : 5	Quantum DLT4000 D578
<a href="#">165</a>	idevice.name165	None	None	No Device Found.
<a href="#">173</a>	idevice.name173	None	None	No Device Found.

External Initiator Summary				
				<a href="#">Help</a>
Initiator Name	Connection Type			
REO Device Name	REO Device ID	Device Type	SCSI Port : ID	Inquiry Information
<a href="#">edinit01</a>	iSCSI			
idevice.name160	<a href="#">160</a>	None	0 : 0	No Device Found.
<a href="#">edinit02</a>	iSCSI			
idevice.name165	<a href="#">165</a>	Tape	0 : 5	Quantum DLT4000 D578
<a href="#">edinit03</a>	iSCSI			
idevice.name179	<a href="#">179</a>	Tape	1 : 4	WangDAT Model 3400DX 8110

If you attach an External Device while the REO Appliance is running, use the Rescan feature to instruct the REO Appliance to detect the device and display the applicable information in the summary.

## To update the list of External Devices

- 1 In the left pane, under **External Device Menu**, click **Rescan for External Devices**.

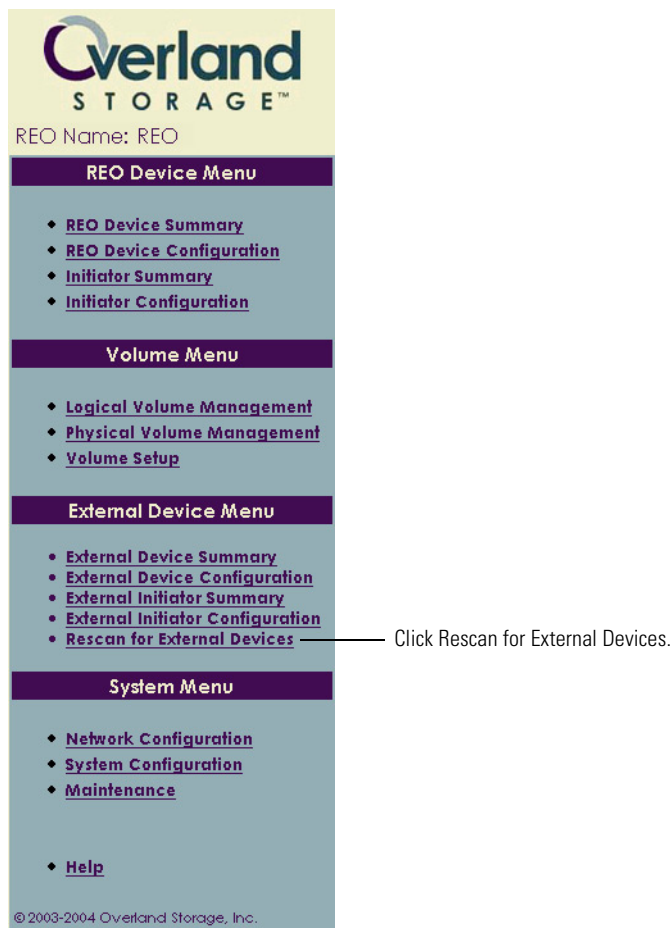

- 2 When the following message appears, click **Rescan** to continue.

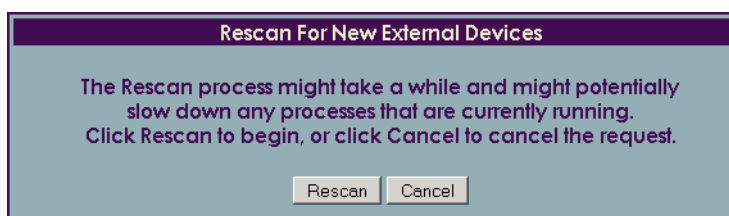

## Changing the iSCSI Target Name

**Important:** The target names must be unique with a network. If you are using multiple appliances, you must change the default target names. For more information, see *Expanding Storage Capacity (Scalability)* on page 107.

- 1 In the left pane, under **External Device Menu**, click **External Device Configuration**.

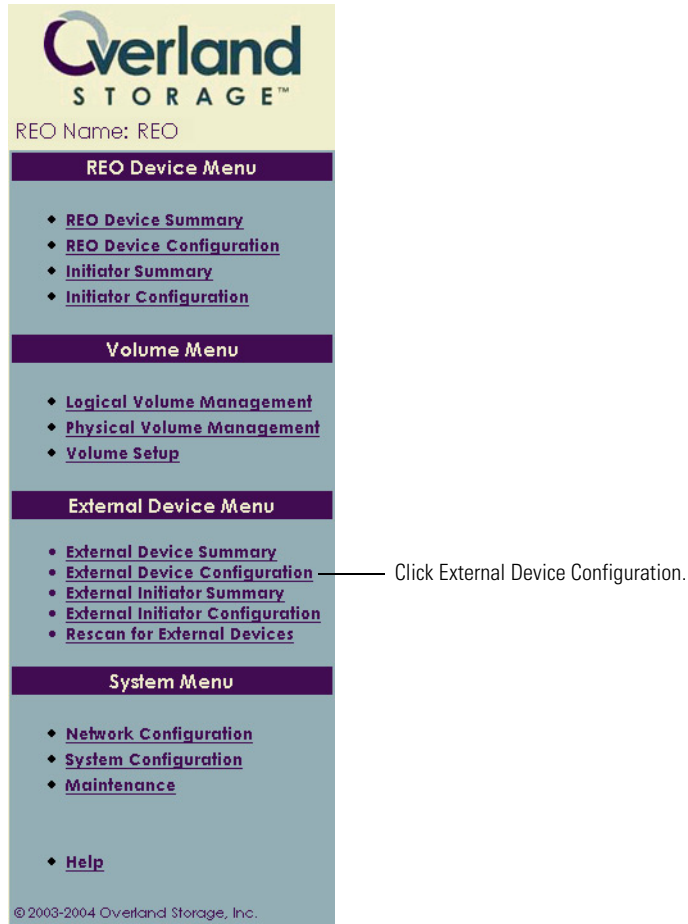

The External Device Configuration page displays the current settings for the first External Device listed in the REO Device ID list.

- 2 From the **REO Device ID** list, select the first device whose configuration you want to change.

The number of device IDs listed depends on the number of devices attached via the SCSI ports. Up to 30 device IDs (15 for each port) might be listed on this page.

- 3 To change the default target name of a device, in the **iSCSI Target Name** box, type the new name (for example, LTO2drive).

**External Device Configuration**

REO Device ID: 163

External Device Information	Setting	Help
Device Type: Tape		
iSCSI Target Name: lto2drive		
Query Information: HP Ultrium 2-SCSI F45H		
SCSI Port: 0		
SCSI ID: 3		
Current initiator access list: None		
<input type="button" value="Submit"/> <input type="button" value="Reset"/> <a href="#">Add New Initiators</a>		

Type a new name (if desired), and then click Submit.

- 4 To save your changes, click **Submit** (or click Reset to cancel). Any changes you make are also reflected on the External Device Summary page.

**External Device Summary**

[Help](#)

REO Device ID	iSCSI Target Name	Device Type	SCSI Port : ID	Inquiry Information
163	lto2drive	Tape	0:3	HP Ultrium 2-SCSI F45H

Changes are reflected on the summary.

- 5 After you complete these steps, proceed to the steps outlined in *Associating Targets (Devices) and Initiators* on page 87.





# 9 | Associating Targets (Devices) and Initiators

CHAPTER

The main steps involved in associating targets (REO Devices) and initiators with each other include:

- Step 1** Understanding how the targets and initiators must be identified so that they can successfully communicate with each other.
- Step 2** Making sure that IP addresses and names match on both the targets and the initiators.
- Step 3** Making another backup copy of the REO SoftKey so that your configuration information is preserved.

## Understanding How Initiators and Targets (Devices) are Connected

To configure the REO Appliance as a backup-and-recovery-acceleration appliance, you must provide target and initiator information. Each volume on the REO Appliance is a target (REO Device); the servers are initiators.

If you are using iSCSI initiators, an iSCSI name is required both at the targets and at the initiators. An iSCSI target name is required because it uniquely identifies a target as a storage resource for the initiators. An iSCSI initiator name is required because it helps identify an initiator for the purpose of target resource allocation (that is, which initiator has access to which target resource).

If you are using FC initiators, you must provide a WWNN and WWPN for the same purpose of providing a unique identifier.

## Reviewing iSCSI Naming Conventions

iSCSI names must be unique within the domain of the end user. However, because user domains can potentially merge with other user domains, the iSCSI naming mechanism is structured to ensure worldwide uniqueness. To ensure both domain and worldwide name uniqueness, iSCSI provides for the use of different types of naming mechanisms, based on the naming authority. Each iSCSI name is prefixed with a short designator string that indicates the type of naming

authority. The *iqn* prefix is used for iSCSI-qualified names and the *eui* prefix is used for Institute of Electrical and Electronics Engineers (IEEE) iSCSI names.

To ensure the free movement of network HBAs between hosts without carrying over the SCSI state information, iSCSI initiator names are associated with iSCSI nodes instead of with network adapter cards. A target name should not be tied to hardware interfaces, which can be changed. A target name should identify the logical target and must be the same for the target, regardless of the physical portion being addressed.

### iSCSI-Qualified Names

iSCSI-qualified names are constructed in four parts, each separated by a decimal. The first part of the name is the *iqn* prefix. The second part of the name is a date code in yyyy-mm format. The third part is a reversed domain name, and the fourth part is any string (within the character set and length boundaries) that uniquely identifies the initiator or target. For example, the iSCSI-qualified name **iqn.2002-07.com.mycompany.storage:drive1** can be broken down into four parts as shown.

Type	Date	Organization	Naming Authority	Subgroup	Naming Authority
iqn	2002-07	com.mycompany		storage:drive1	

Note: To enhance ease-of-use, the REO Appliance uses more simplified iSCSI target names.

### IEEE iSCSI Names

IEEE iSCSI names are used when a manufacturer is already basing unique identifiers on worldwide names, as defined in the SCSI SPC-2 specification (ANSI [American National Standards for Information Systems], 2001. NCITS.351:2001. SCSI Primary Commands - 2 [SPC-2]). IEEE iSCSI names are constructed in two parts, separated by a decimal. The first part of the name is the *eui* prefix. The second part of the name is an EUI-64 address in ASCII hexadecimal (16 digits). For example, the IEEE iSCSI name **eui.02004567A425678D** can be broken down into two parts as shown.

Type	EUI-64	Worldwide Name
eui	02004567A425678D	



## Reviewing How Targets (REO Devices) and Initiators are Associated

After you have named the targets and initiators (described later in this chapter), you must assign them to each other in pairs. This must be performed both on the REO Appliance by using the REO Appliance software console and on the application or backup server by using the iSCSI initiator management tools. The following illustrations demonstrate how this should be accomplished in an iSCSI configuration using the Microsoft iSCSI initiator.

### 1 Match the Data Port IP address on the REO Appliance to the target address on the backup server.

For example, if Data Port 1 on the REO Appliance is assigned an IP address of 10.10.50.42, the IP address on the REO Appliance Network Configuration page must match the target address on the iSCSI configuration tool screens (you must launch the iSCSI configuration tool to obtain this information) for the backup server you are configuring.

The image displays three screenshots illustrating the configuration process:

- Network Configuration:** A screenshot of a web interface showing network settings for three ports:
  - Default Gateway:** IP Address: 0.0.0.0
  - Management Port:** IP Address: 0.0.0.0, Subnet Mask: 0.0.0.0, DHCP:  Enable  Disable
  - Data Port 1:** IP Address: 10.20.16.4, Subnet Mask: 255.255.0.0
- iSCSI Initiator Properties:** A screenshot of the Microsoft iSCSI Initiator Properties dialog box. The 'Target Portals' tab is active, showing a table of available portals:
 

Address	Socket	Adapter	Port
10.20.16.4	3260	Default	Default
- Add Target Portal:** A screenshot of the 'Add Target Portal' dialog box. The 'IP address or DNS name' field contains '10.20.16.4' and the 'Socket' field contains '3260'.

Arrows indicate the flow of information: from the 'Data Port 1' IP address in the Network Configuration page to the 'Add Target Portal' dialog box, and from the 'Add Target Portal' dialog box to the 'Available portals' table in the iSCSI Initiator Properties dialog box.

(To access this dialog box, double-click the Microsoft iSCSI Initiator icon on your desktop.)

(To access the Add Target Portal dialog box, click Add on the Target Portals tab in the iSCSI Initiator Properties dialog box.)

**Note:** The preceding example illustrates using the Microsoft iSCSI Configuration Tool.

## 2 Verify that the iSCSI Target Name on the REO Appliance matches the target name on the backup server.

For example, if one of the volumes on the REO Appliance is named **idevice.name0**, this is the iSCSI Target Name. The target name on the REO Appliance Device Configuration page must match the target name on the iSCSI configuration tool screens for the backup server you are configuring.

**Important:** The target names must be unique within a network. If you are using multiple appliances, you must change the default target names. For more information, see *Expanding Storage Capacity (Scalability)* on page 107.

**REO Device Configuration**

REO Device ID: 0

REO Device Information	Setting	Help
Device Type:	<input checked="" type="radio"/> Disk <input type="radio"/> Tape <input type="radio"/> Dynamic Tape	
ShareDevice:	<input type="checkbox"/>	
Enable Tape Compression:	<input type="checkbox"/>	
Dynamic Tape Max Size:	<input type="text"/> GB	
Target Name:	<input type="text" value="idevice.name0"/>	
Size:	350 GB	
Status:	Up	
FC LUN:	0	
WWNN:	200000062b0778e8	
WWPN(0):	100000062b0778e8	
WWPN(1):	100000062b0778e9	
access list:	None	

**iSCSI Initiator Properties**

iSNS Servers | Persistent Targets | Initiator Settings  
Target Portals | Available Targets | Active Sessions

Description

Select a target and click Log On to access the storage devices for that target. Each logon starts an iSCSI session.

After you log on, you can click the Active Sessions tab to see details about the newly established session.

Select a target:

Name	Status
idevice.name0	Connected

### 3 Match the iSCSI initiator name on the REO Appliance to the initiator name on the backup server.

For example, if one of the volumes on the REO Appliance is named **idevice.name0**, this is the iSCSI Target Name. You must assign at least one initiator to this target (if you do not, you will not be able to access the disk). The iSCSI initiator name on the initiator portion of the REO Appliance Device Configuration page must match the initiator name on the iSCSI configuration tool screen for the backup server you are configuring.

The Initiator IP Address field is optional. If used, both the iSCSI initiator name and the IP address will be checked by the REO Appliance and must match for access to be granted.

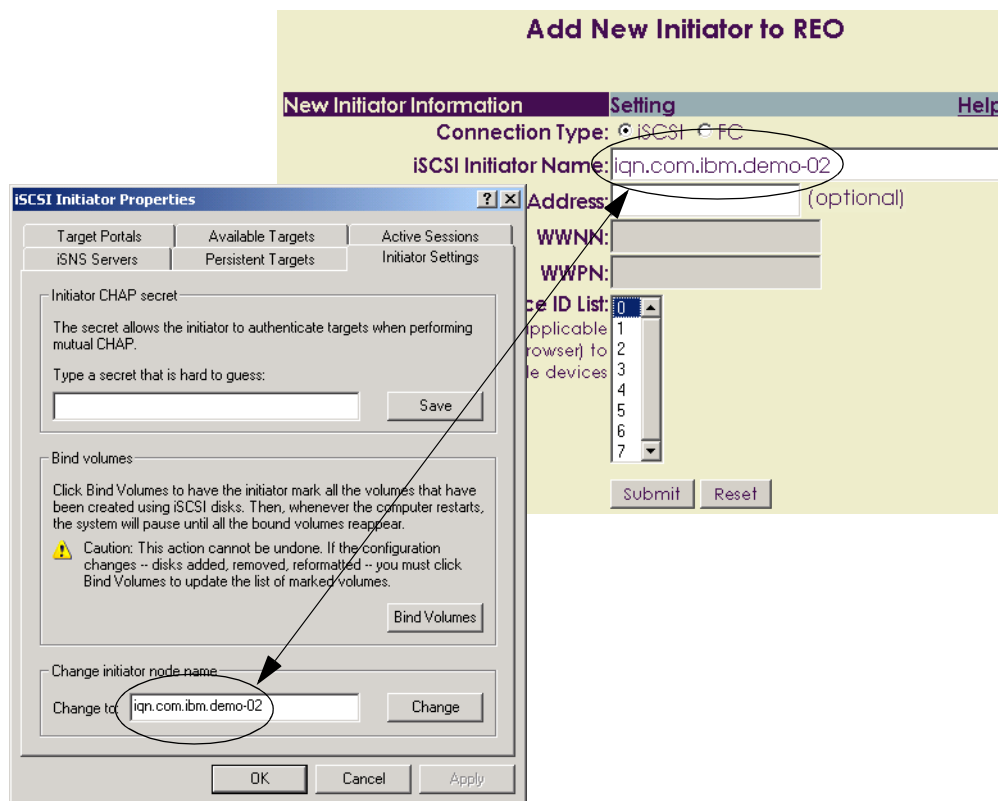

## Configuring Targets (REO Devices and External Devices) and Initiators

Each disk or LUN on the REO Appliance is an iSCSI or FC target and has a passive role in fulfilling requests initiated by the application or backup server.

The backup server is an initiator and plays the active role in issuing commands. An initiator is configured in conjunction with targets on the REO Appliance as an access control mechanism. You must configure an initiator by using the initiator software *and* by using the REO Appliance console. You can assign up to eight initiators (iSCSI, FC, or a combination of both) to each REO disk device (a virtual tape device currently supports only one initiator) or External Device.

## Configuring REO Devices (Targets) and Initiators

- 1 In the left pane, under **REO Device Menu**, click **REO Device Configuration**.

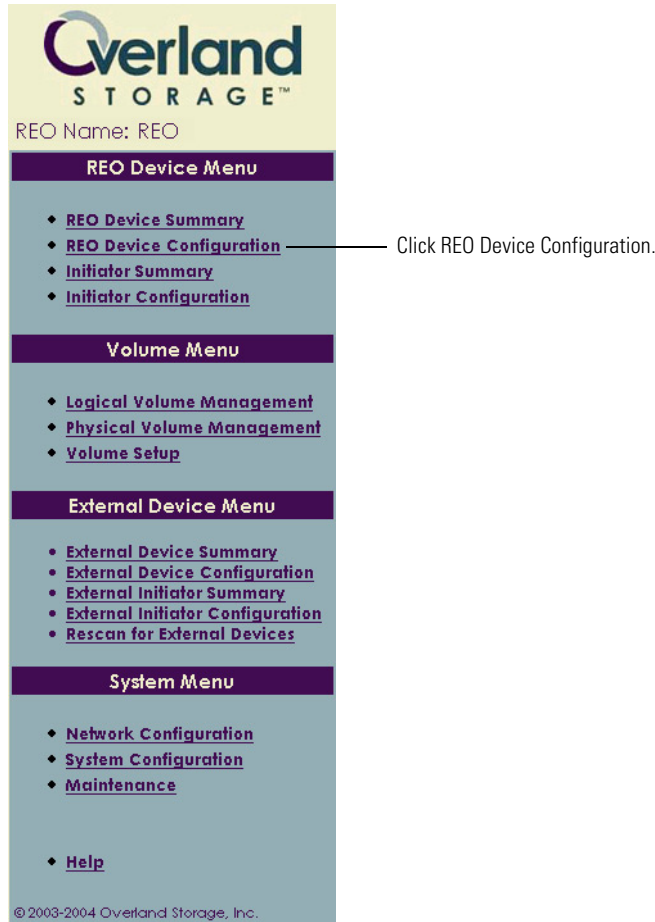

The iSCSI Target Name fields are assigned default values of **iddevice.name0** through **iddevice.name23** (JBOD); **iddevice.name0**, **iddevice.name1**, **iddevice.name12**, and **iddevice.name13** (RAID 0 or 5, without logical volumes); or **iddevice.name0** up through **iddevice.name63** (RAID 0 or 5, with up to 64 logical volumes).

---

**Important:** The target names must be unique within a network. If you are using multiple appliances, you must change the default target names. For more information, see *Expanding Storage Capacity (Scalability)* on page 107.

---

- 2 To change an **iSCSI Target Name**, type the new name in the text box, and then click **Submit**.

**REO Device Configuration**

REO Device ID: 0

REO Device Information	Setting	Help
Device Type:	<input checked="" type="radio"/> Disk <input type="radio"/> Tape <input type="radio"/> Dynamic Tape	
ShareDevice:	<input type="checkbox"/>	
Enable Tape Compression:	<input type="checkbox"/>	
Dynamic Tape Max Size:	<input type="text"/> GB	
iSCSI Target Name:	<input type="text" value="idevice.name0"/>	
Size:	350 GB	
Status:	Up	
FC LUN:	0	
WWNN:	200000062b0778e8	
WWPN(0):	100000062b0778e8	
WWPN(1):	100000062b0778e9	
Current initiator access list:	None	
<input type="button" value="Submit"/> <input type="button" value="Reset"/> <input type="button" value="Add New Initiators"/>		

To change a target's name, type the new name in this box, and then click Submit.

- 3 From the **REO Device ID** list, select the device for which you want to add initiators, and then click **Add New Initiators**.

**REO Device Configuration**

REO Device ID: 0

REO Device Information	Setting	Help
Device Type:	<input checked="" type="radio"/> Disk <input type="radio"/> Tape <input type="radio"/> Dynamic Tape	
ShareDevice:	<input type="checkbox"/>	
Enable Tape Compression:	<input type="checkbox"/>	
Dynamic Tape Max Size:	<input type="text"/> GB	
iSCSI Target Name:	<input type="text" value="idevice.name0"/>	
Size:	350 GB	
Status:	Up	
FC LUN:	0	
WWNN:	200000062b0778e8	
WWPN(0):	100000062b0778e8	
WWPN(1):	100000062b0778e9	
Current initiator access list:	None	
<input type="button" value="Submit"/> <input type="button" value="Reset"/> <input type="button" value="Add New Initiators"/>		

Select the device, and then click Add New Initiators.

- 4 If you are working with *iSCSI*, do the following:
- In the **Connection Type** section, make sure that **iSCSI** is selected (this is the default).
  - In the **iSCSI Initiator Name** box, enter a unique name (up to 223 alphabetical or numerical characters) of an authorized initiator for the target.

The fully qualified iSCSI name is assigned by the manufacturer of either the software initiator or the storage adapter installed on your backup server.

The iSCSI initiator name entered here *must* match the name of the iSCSI initiator on the associated backup server.

**Tip:** To copy the initiator name if you are using the Microsoft initiator driver and then paste it here, use the initiator configuration tool. Click the Initial Settings tab, highlight the initiator node name, click Edit, and copy the initiator node name.

The screenshot shows the 'Add New Initiator to REO' form with the following fields and annotations:

- Connection Type:** Radio buttons for iSCSI (selected) and FC.
- iSCSI Initiator Name:** Text box containing 'iqn.com.ibm.demo-02'. An annotation points to this field: 'Enter the unique name of the initiator, select the ID, and click Submit.'
- Initiator IP Address:** Text box with '(optional)' next to it.
- WWNN:** Text box.
- WWPN:** Text box.
- REO Device ID List:** A list box with options 0 through 7. An annotation points to this list: 'Use Ctrl key (or applicable mechanism for your browser) to select multiple devices'.
- Buttons:** 'Submit' and 'Reset' buttons at the bottom.

**c** (Optional) In the **Initiator IP Address** box, if you want to use an additional level of authentication, use dotted decimal notation to enter the IP address of the backup server.

If present, the IP address of the initiator is compared with the IP address you enter here.

**5** If you are working with *Fibre Channel*, do the following:

- a** In the **Connection Type** section, select **FC**.
- b** In the **WWNN** and **WWPN** boxes, enter the official node and port names of the authorized initiator for the target.

**Tip:** You can retrieve the initiator WWNN and WWPN by using the specific FC host adapter management software utility or by querying the name server on the FC switch.

The screenshot shows the 'Add New Initiator to REO' form with the following fields and annotations:

- Connection Type:** Radio buttons for iSCSI and FC (selected). An annotation points to this section: 'Select FC, enter the node and port names for the initiator, select the ID, and click Submit.'
- iSCSI Initiator Name:** Text box.
- IP Address:** Text box.
- WWNN:** Text box containing '300000071d080c44'.
- WWPN:** Text box containing '100000086b079d22'.
- REO Device ID List:** A list box with options 0 through 7. An annotation points to this list: 'Use Ctrl key (or applicable mechanism for your browser) to select multiple devices'.
- Buttons:** 'Submit' and 'Reset' buttons at the bottom.

- 6 From the **REO Device ID** list, select the ID for the target to which you are assigning this initiator.
- 7 Click **Submit**.
- 8 Repeat step 3 through step 7 for each target.

## Configuring the iSCSI Initiator with Target (REO Device) and Initiator Assignments

- ▶ On each applicable server, use the management tool that came with your iSCSI initiator to specify the target (REO Device) information.

To configure the REO Appliance as a backup-and-recovery-acceleration appliance, you must provide target (REO Device) and initiator (host) information. An iSCSI name (for iSCSI) or a set of WWNN and WWPN names (for FC) is required for both the targets and the initiators. After targets and initiators have been specified, they must be assigned to each other. This must be performed on the server by using the software or hardware initiator, and on the REO Appliance by using the REO Appliance console, which you completed in the previous section.

**Note:** For detailed information on various drivers and adapters, see the manufacturer's documentation for assistance on assigning targets. You can also check the Overland Web site ([www.overlandstorage.com](http://www.overlandstorage.com)) for the applicable Application Notes.

## Configuring External Devices (Targets) and Initiators

This process is similar to the steps outlined earlier for configuring REO devices. For detailed information, refer back to *Configuring REO Devices (Targets) and Initiators*.

- 1 In the left pane, under **External Device Menu**, click **External Device Configuration**.

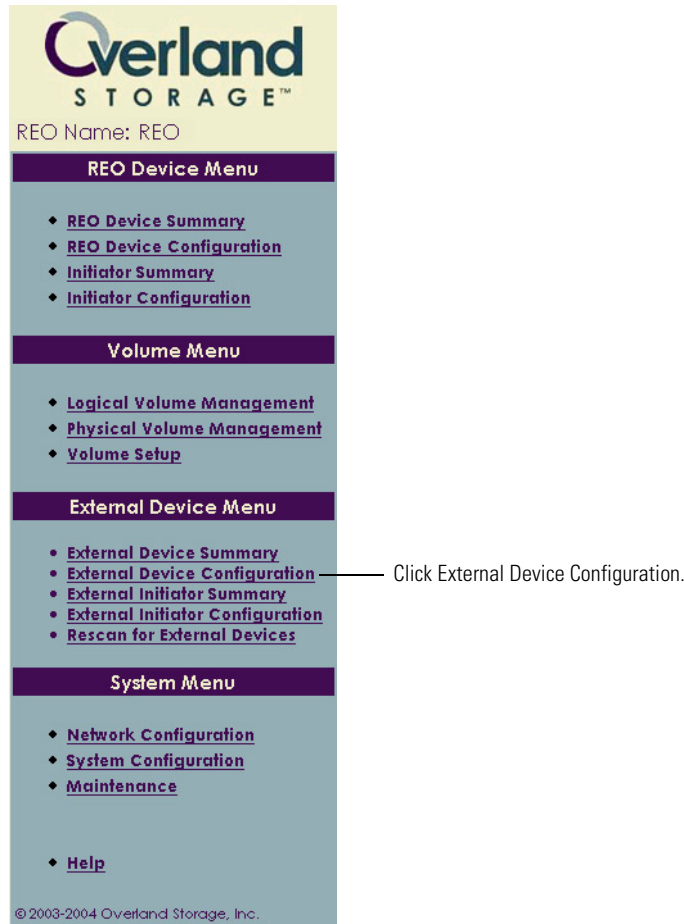

The iSCSI Target Name fields are assigned default values of **iddevice.name160** through **iddevice.name189**. For details on changing a name, see *Changing the iSCSI Target Name* on page 84.

- 2 From the **REO Device ID** list, select the device for which you want to add initiators, and then click **Add New Initiators**.

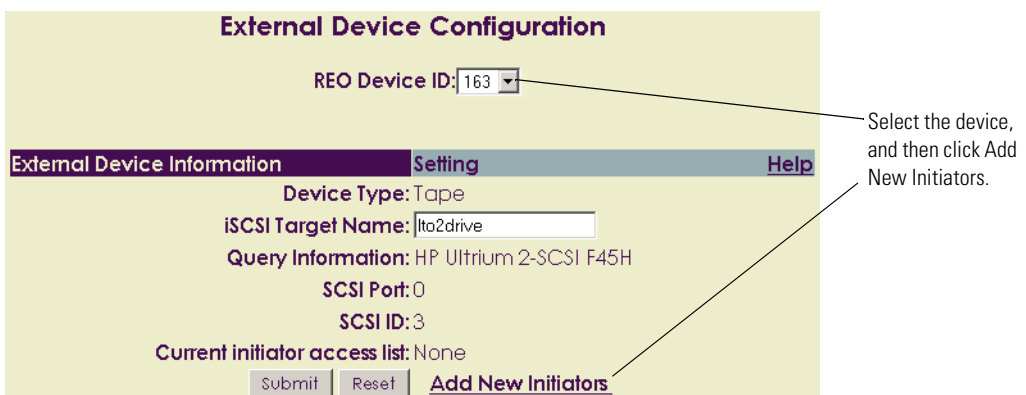



- 3 In the **iSCSI Initiator Name** box, enter a unique name (up to 223 alphabetical or numerical characters) of an authorized initiator for the target.

- 4 (Optional) In the **Initiator IP Address** box, if you want to use an additional level of authentication, use dotted decimal notation to enter the IP address of the backup server.  
If present, the IP address of the initiator is compared with the IP address you enter here.
- 5 From the **REO Device ID** list, select the ID for the target to which you are assigning this initiator.
- 6 Click **Submit**.
- 7 Repeat step 2 through step 6 for each target.

## Configuring the iSCSI Initiator with Target (External Device) and Initiator Assignments

- ▶ On each applicable server, use the management tool that came with your iSCSI initiator to specify the target (External Device) information.

## Backing Up Your REO SoftKey (Post-Configuration)

Make another backup copy of all the files on the REO SoftKey.

- 1 Transfer the REO SoftKey to a USB port on a Windows 2000, 2003, or XP system that contains active virus-protection software.
- 2 If you are using Windows, double-click **My Computer** on your desktop (or use Windows Explorer), and browse to the software-key disk drive.  
The name of this disk varies based on your system configuration, but it will be called something like Removable Disk (G:).
- 3 Make a backup copy of all the data on the REO SoftKey, and store the copy in a secure location.





# 10 Working with the REO 9000

## CHAPTER

This chapter provides a few tips on working with the REO Appliance including:

- Logging on to the Web interface.
- Reviewing the information displayed in the REO Device Summary.
- Switching from one configuration to another.
- Understanding how disk drives are numbered.
- Powering down the REO Appliance.

## Logging On from Any System with Network Access

After you have completed configuration of the REO Appliance, you can access the REO Appliance console from any system that has network access to the IP address of the Management Port.

- 1 Choose one of the following:
  - If you are using DHCP, using the management system, access the mapped drive \\REO\programs, and then double-click the **Overland.html** file.
  - If you are not using DHCP, in your Web browser, type the IP address assigned to the Management Port for the REO Appliance.

Tip: You can also use the IP addresses assigned to the Data Ports, which you can do even if you are using DHCP.

- 2 When the prompt appears, type your name and password (the defaults are Administrator and system) *in case-sensitive format*.

SYSTEM LOG ON

Enter logon name and password:

Logon Name:

Password:

The REO Appliance console appears.



REO Name: REO

**REO Device Menu**

- [REO Device Summary](#)
- [REO Device Configuration](#)
- [Initiator Summary](#)
- [Initiator Configuration](#)

**Volume Menu**

- [Logical Volume Management](#)
- [Physical Volume Management](#)
- [Volume Setup](#)

**External Device Menu**

- [External Device Summary](#)
- [External Device Configuration](#)
- [External Initiator Summary](#)
- [External Initiator Configuration](#)
- [Rescan for External Devices](#)

**System Menu**

- [Network Configuration](#)
- [System Configuration](#)
- [Maintenance](#)
- [Help](#)

© 2003-2004 Overland Storage, Inc.

## REO<sub>9000</sub><sup>™</sup>

with ProtectionPAC<sup>™</sup>

### REO Device Summary [Help](#)

REO Device ID	iSCSI Target Name	FC LUN	Status	Device Type	Size (GB)
0	idevice.name0	0	Up	Disk	399
1	idevice.name1	1	Up	Disk	399
2	idevice.name2	2	Up	Disk	399
3	idevice.name3	3	Up	Disk	399
4	idevice.name4	4	Up	Disk	399
5	idevice.name5	5	Up	Disk	399
6	idevice.name6	6	Up	Disk	399
7	idevice.name7	7	Up	Disk	399
8	idevice.name8	8	Up	Disk	399
9	idevice.name9	9	Up	Disk	399
10	idevice.name10	10	Up	Disk	399
11	idevice.name11	11	Up	Disk	399
12	idevice.name12	12	Up	Disk	399
13	idevice.name13	13	Up	Disk	399
14	idevice.name14	14	Up	Disk	399
15	idevice.name15	15	Up	Disk	399
16	idevice.name16	16	Up	Disk	399
17	idevice.name17	17	Up	Disk	399
18	idevice.name18	18	Up	Disk	399
19	idevice.name19	19	Up	Disk	399
20	idevice.name20	20	Up	Disk	399
21	idevice.name21	21	Up	Disk	399
22	idevice.name22	22	Up	Disk	399
23	idevice.name23	23	Up	Disk	399

If compression is enabled, *Tape* appears in italics. If ShareDevice is enabled, *Disk* appears in italics.  
If status appears in any other color than green, see the physical management page!

Note: If multiple users log on to the console at the same time, the console saves the last update received.

## Understanding the Summary Pages

The ProtectionPAC software includes a summary page that lists the REO Devices and another that lists the initiators. If you are using external devices, there are also corresponding summary pages for those devices and initiators.

## Reviewing the REO Device Summary Page

The REO Device Summary page provides an immediate view of your REO Appliance and its status. The following shows two examples of what you might see on this page (what you see depends on how you configure your REO Appliance).

REO Device Summary						<a href="#">Help</a>
REO Device ID	iSCSI Target Name	FC LUN	Status	Device Type	Size (GB)	
<u>0</u>	<i>idevice.name0</i>	0	Up	Tape	399	
<u>1</u>	<i>idevice.name1</i>	1	Up	Tape	399	
<u>2</u>	<i>idevice.name2</i>	2	Up	Tape	399	
<u>3</u>	<i>idevice.name3</i>	3	Up	Disk	399	
<u>4</u>	<i>idevice.name4</i>	4	Up	Disk	399	
<u>5</u>	<i>idevice.name5</i>	5	Up	Disk	399	
<u>6</u>	<i>idevice.name6</i>	6	Up	Disk	399	
<u>7</u>	<i>idevice.name7</i>	7	Up	Disk	399	
<u>8</u>	<i>idevice.name8</i>	8	Up	Disk	399	
<u>9</u>	<i>idevice.name9</i>	9	Up	Disk	399	
<u>10</u>	<i>idevice.name10</i>	10	Up	Disk	399	
<u>11</u>	<i>idevice.name11</i>	11	Up	Disk	399	
<u>12</u>	<i>idevice.name12</i>	12	Up	Disk	399	
<u>13</u>	<i>idevice.name13</i>	13	Up	Disk	399	
<u>14</u>	<i>idevice.name14</i>	14	Up	Disk	399	
<u>15</u>	<i>idevice.name15</i>	15	Up	Disk	399	
<u>16</u>	<i>idevice.name16</i>	16	Up	Disk	399	
<u>17</u>	<i>idevice.name17</i>	17	Up	Disk	399	
<u>18</u>	<i>idevice.name18</i>	18	Up	Disk	399	
<u>19</u>	<i>idevice.name19</i>	19	Up	Disk	399	
<u>20</u>	<i>idevice.name20</i>	20	Up	Disk	399	
<u>21</u>	<i>idevice.name21</i>	21	Up	Disk	399	
<u>22</u>	<i>idevice.name22</i>	22	Up	Disk	399	
<u>23</u>	<i>idevice.name23</i>	23	Up	Disk	399	

If compression is enabled, *Tape* appears in italics. If ShareDevice is enabled, *Disk* appears in italics. If status appears in any other color than green, see the physical management page!

This image shows the JBOD configuration on an FC-enabled appliance. Three of the REO Devices have been configured to function as virtual LTO-2 tape devices.

This image shows the RAID 5 configuration, with logical volumes, on an FC-enabled appliance. The connections have all been changed to operate through FC. Five logical volumes have been created at this point.

REO Device Summary						<a href="#">Help</a>
REO Device ID	iSCSI Target Name	FC LUN	Status	Device Type	Size (GB)	
<u>0</u>	<i>idevice.name0</i>	0	Up	Disk	110	
<u>1</u>	<i>idevice.name1</i>	1	Up	Disk	200	
<u>2</u>	<i>idevice.name2</i>	2	Up	Disk	10	
<u>3</u>	<i>idevice.name3</i>	3	Up	Disk	10	
<u>4</u>	<i>idevice.name4</i>	4	Up	Disk	10	

If compression is enabled, *Tape* appears in italics. If ShareDevice is enabled, *Disk* appears in italics. If status appears in any other color than green, see the physical management page!

The following explains each of the columns:

- **REO Device ID.** This entry is automatically designated by the REO Appliance. Depending on the configuration, you might have up to 64 IDs in this list.
- **iSCSI Target Name.** Displays either the default name assigned by the REO Appliance or the new name assigned by you.
- **FC LUN.** If you purchased the FC-enabled appliance, this column displays the LUN for each device.

- **Status.** Indicates whether the device is Up or Down. In addition to using an Up or Down label, the color green indicates that the item is okay, orange indicates that the item is in an unprotected state (for example, initializing), and red indicates that the item is unavailable (for example, a disk is missing).

**Note:** This status is different from that which is shown on the Physical Volume Management page. For example, if you switch from a JBOD configuration to a RAID 5 configuration, the status of the two device IDs on the summary page will be Up, while the status for the two volumes on the Physical Volume Management Page will be INITIALIZING.

- **Device Type.** Indicates whether the device is exported as a disk drive or as a virtual LTO-2 tape drive. If you create a Tape Device or Dynamic Tape Device and select the Enable Tape Compression check box, Tape (or Dynamic Tape) appears in italic formatting in this column. If you use the ShareDevice feature, Disk appears in italic formatting.

- **Size (GB).** Indicates the amount of space allocated to the device.

**Tip:** To access the REO Device Configuration page for a specific device, click the applicable REO Device ID.

## Reviewing the Initiator Summary Page

The Initiator Summary page provides an immediate view of the initiators (systems) that you have defined for the REO Devices. For each initiator, this page shows information such as which devices (targets) it is associated with and the type of connection.

The following image shows the initiators for a RAID configuration using logical volumes on an FC-enabled appliance.

Initiator Summary					<a href="#">Help</a>
Initiator Name	Connection Type				
REO Device Name	REO Device ID	Device Status	Device Type	Size (GB)	
<a href="#">sampleiscsiinit01</a>	iSCSI				
<a href="#">idevice.name0</a>	<a href="#">0</a>	Up	Disk	100	
<a href="#">sampleiscsiinit02</a>	iSCSI				
<a href="#">idevice.name1</a>	<a href="#">1</a>	Up	Disk	100	
<a href="#">sampleiscsiinit03</a>	iSCSI				
<a href="#">idevice.name9</a>	<a href="#">9</a>	Up	Disk	25	
<a href="#">ff01ff01ff01ff01</a>	FC				
<a href="#">idevice.name6</a>	<a href="#">6</a>	Up	Dynamic Tape	1	
<a href="#">idevice.name7</a>	<a href="#">7</a>	Up	Disk	3	
<a href="#">idevice.name8</a>	<a href="#">8</a>	Up	Tape	25	
<a href="#">aa00aa00aa00aa00</a>	FC				
<a href="#">idevice.name4</a>	<a href="#">4</a>	Up	Disk	50	

If compression is enabled, *Tape* appears in italics. If ShareDevice is enabled, *Disk* appears in italics. If status appears in any other color than green, see the physical management page!

**Tip:** To access the Initiator Configuration page for a specific initiator, click the applicable Initiator Name. To access the REO Device Configuration page for a specific device, click the applicable REO Device ID.

## Reviewing the External Device Summary

The External Device Summary page provides an immediate view of the External Devices attached to the REO Appliance.

External Device Summary				
REO Device ID	iSCSI Target Name	Device Type	SCSI Port : ID	Inquiry Information
163	lto2drive	Tape	0:3	HP Ultrium 2-SCSI F45H

The following explains each of the columns:

- **REO Device ID.** This entry is automatically designated by the REO Appliance. Depending on the configuration, you might have up to 30 IDs in this list.
- **iSCSI Target Name.** Displays either the default name assigned by the appliance or the new name assigned by you.
- **Device Type.** Indicates whether the device is exported as a Changer (medium changer), Tape (tape drive), or CD/DVD (CD-ROM or DVD drive).
- **SCSI Port:ID.** Identifies the SCSI port through which the device is attached and the SCSI ID of the device itself.
- **Inquiry Information.** Displays information published by the device itself (for example, the type of drive technology that the device uses).

## Reviewing the External Initiator Summary Page

The External Initiator Summary page provides an immediate view of the initiators (systems) that you have defined for the External Devices (targets). For each initiator, this page shows which devices (targets) it is associated with and any information known about those devices.

External Initiator Summary				
Initiator Name	Connection Type			
REO Device Name	REO Device ID	Device Type	SCSI Port : ID	Inquiry Information
edinit01	iSCSI			
idevice.name160	160	None	0 : 0	No Device Found.
edinit02	iSCSI			
idevice.name165	165	Tape	0 : 5	Quantum DLT4000 D578
edinit03	iSCSI			
idevice.name179	179	Tape	1 : 4	WangDAT Model 3400DX 8110

**Tip:** To access the External Initiator Configuration page for a specific initiator, click the applicable Initiator Name. To access the External Device Configuration page for a specific device, click the applicable REO Device ID.

## Reviewing How the Disk Drives are Numbered

Numbering begins with the disk in the upper-left corner (disk 0) and moves from left to right.

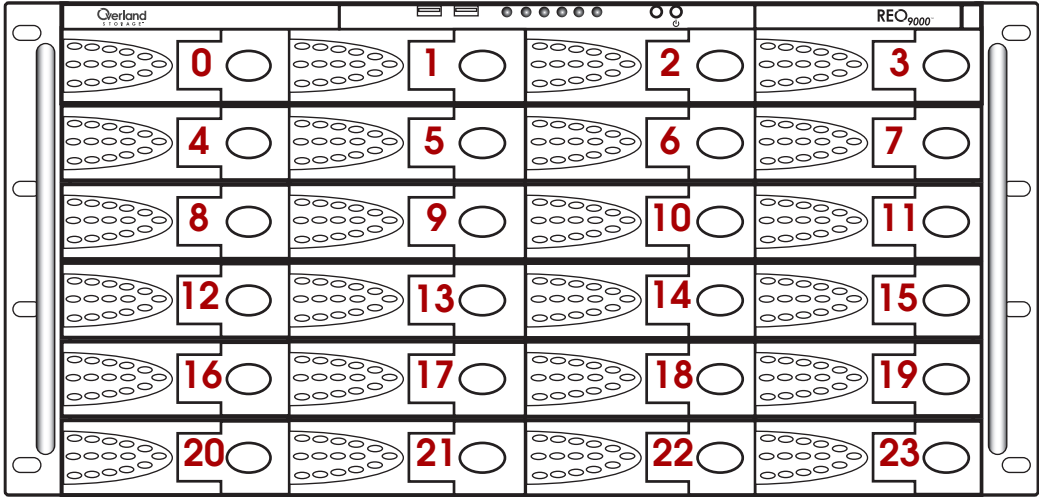

## Understanding What the LEDs Represent

The front of the appliance includes several LED lights. If an LED for a port (network connection) is blinking, it indicates that the port is in use. The LED that represents power indicates whether power is enabled.

Each disk drive also presents two LEDs: one for power and one for activity.

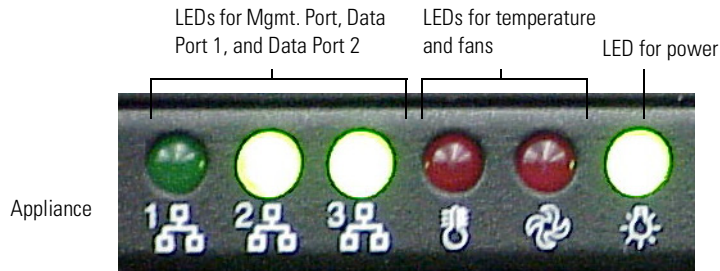

Appliance

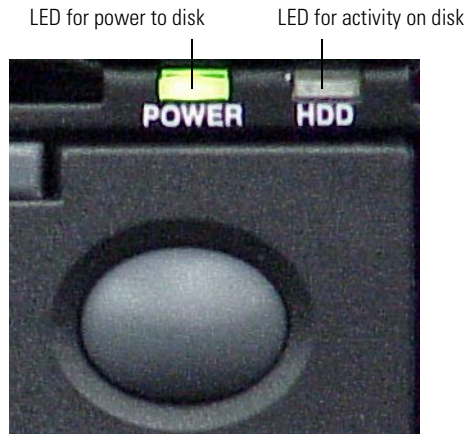

Hard disk



## Powering Down the REO Appliance

To ensure preservation of data on the REO Appliance, do *not* turn off the appliance using the power button on the REO Appliance. You must verify that none of the initiators have active connections, and you should use the Shutdown/Restart option in the software console to power down the REO Appliance.

- 1 Make sure that none of the initiators (servers) have active connections with the REO Appliance.

For example, in the iSCSI Initiator Properties dialog box for the Microsoft initiator, you can check the Active Sessions tab to determine if there is a connection that needs to be terminated.

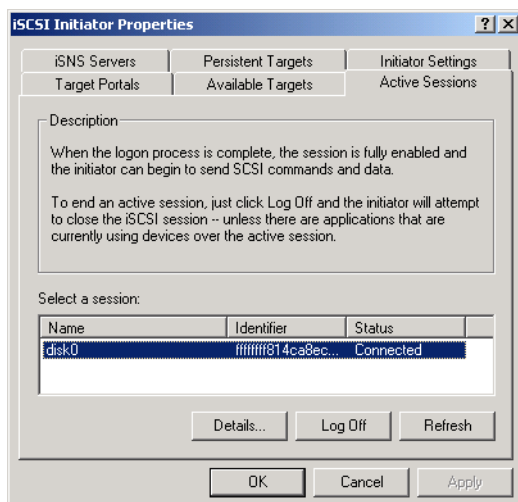

- 2 In the software console, under **System Menu**, click **Maintenance**.

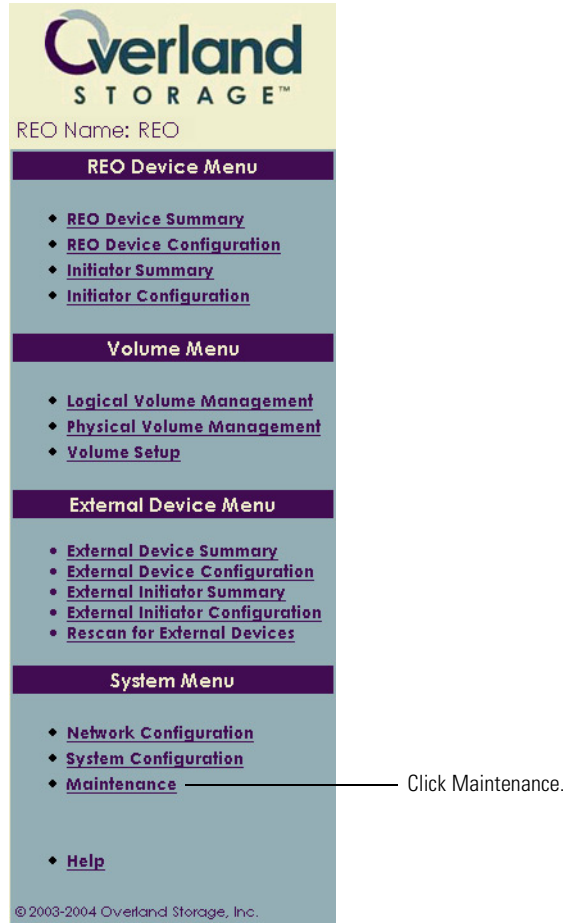

- 3 In the **System Maintenance** page, under **Shut Down/Restart**, click the applicable button.
- If you want to shut down the REO Appliance briefly and then automatically restart it, click **Restart**. When the confirmation message appears, click **OK** to continue. Wait several minutes before you log back on to the console.
  - If you want to shut down the REO Appliance and leave the power off, click **Shut Down**. When the confirmation message appears, click **OK** to continue. Wait several minutes before you perform any maintenance on the REO Appliance.





# 1 | Expanding Storage Capacity (Scalability)

CHAPTER

This chapter explains how to add one or more additional REO Appliance appliances to expand the storage capacity in an iSCSI or FC environment. If you are using the 12-disk version of the REO 9000 and you subsequently purchased the additional 12-disk upgrade kit, it also describes how to add the additional disks to the appliance.

---

**Important:** If you purchased multiple units, set up (attach and configure) one unit at a time. The target names must be unique within a network; that is, if you are using multiple appliances, you must change the default target names.

---

## Setting Up Additional REO Appliances in an iSCSI Configuration

- 1 Install, configure, and manage *each* REO Appliance that you purchased using the *same* instructions provided for the REO Appliance that it complements.  
Using this method, you will have multiple, independent management consoles.
- 2 Enable power to the first appliance and complete the configuration process before enabling power to the next appliance, and so on.

**Important:** Because *each* appliance (the primary REO Appliance and each associated REO Appliance) has its own console, change the default values for the iSCSI Target Name fields on the REO Device Configuration page, and change the REO Name and REO Description fields (the default is REO) under System Information on the System Configuration page so that *all* names are unique.

**REO Device Configuration**

REO Device ID: 0

REO Device Information	Setting	Help
Device Type:	<input checked="" type="radio"/> Disk <input type="radio"/> Tape <input type="radio"/> Dynamic Tape	
ShareDevice:	<input type="checkbox"/>	
Enable Tape Compression:	<input type="checkbox"/>	
Dynamic Tape Max Size:	<input type="text"/> Gb	
iSCSI Target Name:	<input type="text" value="idevice.name0"/>	
Size:	350 GB	
Status:	Up	
FC LUN:	0	
WWNN:	200000062b0778e8	
WWPN(0):	100000062b0778e8	
WWPN(1):	100000062b0778e9	
Current initiator access list:	None	
<input type="button" value="Submit"/> <input type="button" value="Reset"/> <input type="button" value="Add New Initiators"/>		

System Information	Setting	Help
Workgroup/Domain Name:	WORKGROUP	
REO Name:	REO	
REO Description:	REO Appliance	
<input type="button" value="Apply"/> <input type="button" value="Reset"/>		

Change every iSCSI Target Name, REO Name, and REO Description to use a unique name.

## Setting Up Additional REO Appliances in an FC Topology

There are two options for adding additional REO Appliances to your FC environment. You can attach each REO Appliance to its own set of ports on an FC switch in a fabric or point-to-point topology. For a loop topology, attach each REO Appliance to its own set of ports on an FC hub.

The Fibre Channel ports on the back of the REO Appliance are numbered port 0 (bottom) and port 1 (top).

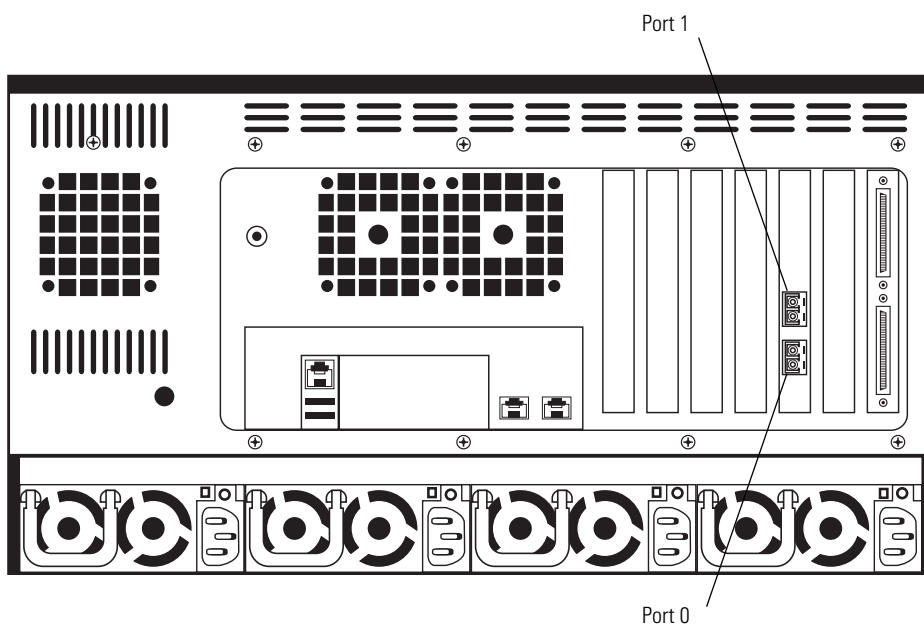

## Attaching Each REO Appliance Separately

- 1 Attach each REO Appliance in the set to a separate set of ports on the FC switch or hub.

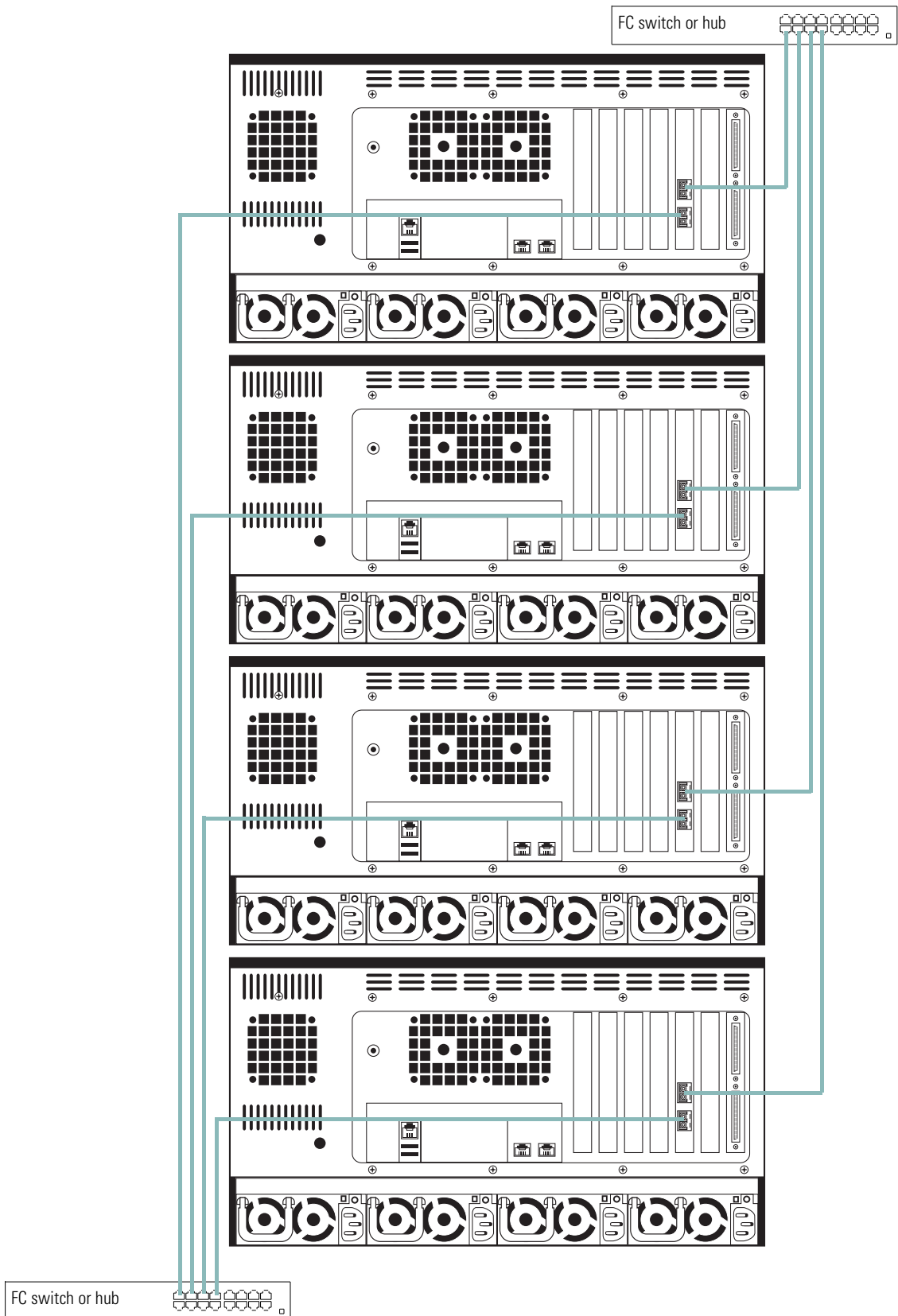

- 2 Configure and manage *each* REO Appliance using the *same* instructions provided for the REO Appliance that it complements.

**Important:** Because *each* appliance (the primary REO Appliance and each associated REO Appliance) has its own console, change the default values for the iSCSI Target Name fields on the REO Device Configuration page, and change the REO Name and REO Description fields under System Information on the System Configuration page so that *all* names are unique. Also change the FC-specific information on the Network Configuration page for each additional REO Appliance.

REO Device Configuration

REO Device ID: 0

REO Device Information	Setting	Help
Device Type:	<input checked="" type="radio"/> Disk <input type="radio"/> Tape <input type="radio"/> Dynamic Tape	
ShareDevice:	<input type="checkbox"/>	
Enable Tape Compression:	<input type="checkbox"/>	
Dynamic Tape Max Size:	<input type="text"/> GB	
iSCSI Target Name:	<input type="text" value="idevice.name0"/>	
Size:	350 GB	
Status:	Up	
FC LUN:	0	
WWNN:	200000062b0778e8	
WWPN(0):	100000062b0778e8	
WWPN(1):	100000062b0778e9	
Current initiator access list:	None	
	<input type="button" value="Submit"/> <input type="button" value="Reset"/> <input type="button" value="Add New Initiators"/>	

Change every iSCSI Target Name, REO Name, and REO Description to use a unique name.

System Information	Setting	Help
Workgroup/Domain Name:	<input type="text" value="WORKGROUP"/>	
REO Name:	<input type="text" value="REO"/>	
REO Description:	<input type="text" value="REO Appliance"/>	
	<input type="button" value="Apply"/> <input type="button" value="Reset"/>	

Fibre Channel Configuration	Setting	Help
WWNN:	200000062b080c44	
WWPN(0):	100000062b080c44	
Link State:	Online	
Topology:	Private Loop	
Link Speed:	2 GB	
Set Link Speed:	<input type="text" value="Auto"/>	
Set Link Topology:	<input type="text" value="Auto"/>	
WWPN(1):	100000062b080c45	
Link State:	Online	
Topology:	Private Loop	
Link Speed:	2 GB	
Set Link Speed:	<input type="text" value="Auto"/>	
Set Link Topology:	<input type="text" value="Auto"/>	
	<input type="button" value="Apply"/> <input type="button" value="Reset"/>	

## Expanding the Capacity of a REO 9000 by Adding Disk Drives

If you initially purchased a REO 9000 with 12 disks and subsequently purchased the upgrade for an additional 12 disks, complete the following steps to install the additional disks.

**Important:** Overland Storage recommends that this part be installed by an authorized IT service person or an Overland Storage-authorized service provider. Improper installation may result in damage to this part or the appliance which will void the current warranty.

- 1 Make sure that the none of the initiators (servers) have active connections with the appliance.
- 2 Open the face-plate to expose the individual disk-drive slots.
- 3 Remove the first *empty* disk carrier (disk 12) by pressing the button on the front of the carrier and using the lever to pull the carrier out of the slot.

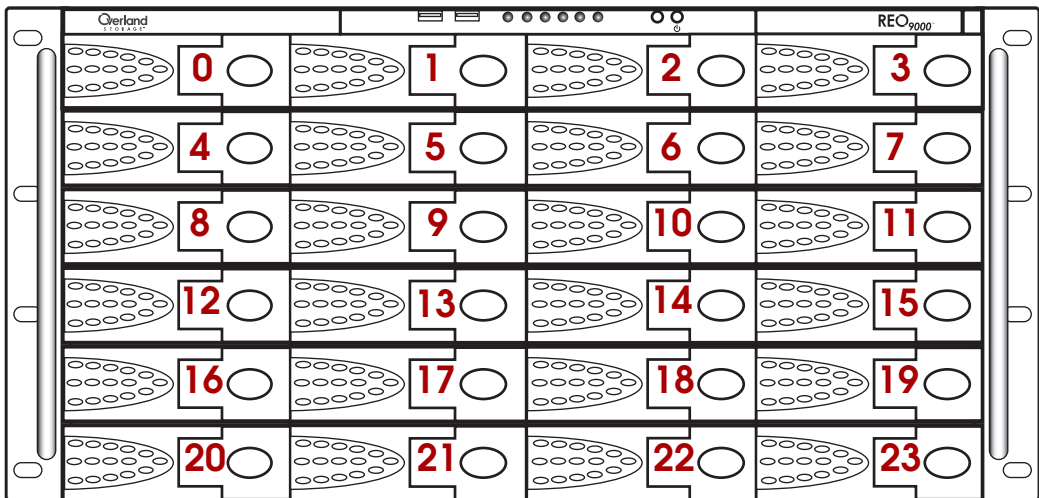

- 4 If the new disk carrier (which contains a disk) is not labeled with a slot number, use a blank label from the accessory kit to label the new carrier as disk 12.
- 5 Insert the new disk carrier (disk 12) into the applicable slot on the appliance, and close the disk carrier by making sure that the lever is in its fully extended, open position; pressing the right side of the carrier into the slot; and then pressing the lever in.  
Pressing the lever in draws the carrier fully into the slot and locks it in place.
- 6 Repeat step 4 and step 5 for each new disk carrier, labeling them in order, until all 12 additional disk drives are seat in the appliance.
- 7 Close the face-plate.



- 8 In the left pane, under **Volume Menu**, click **Physical Volume Management**.

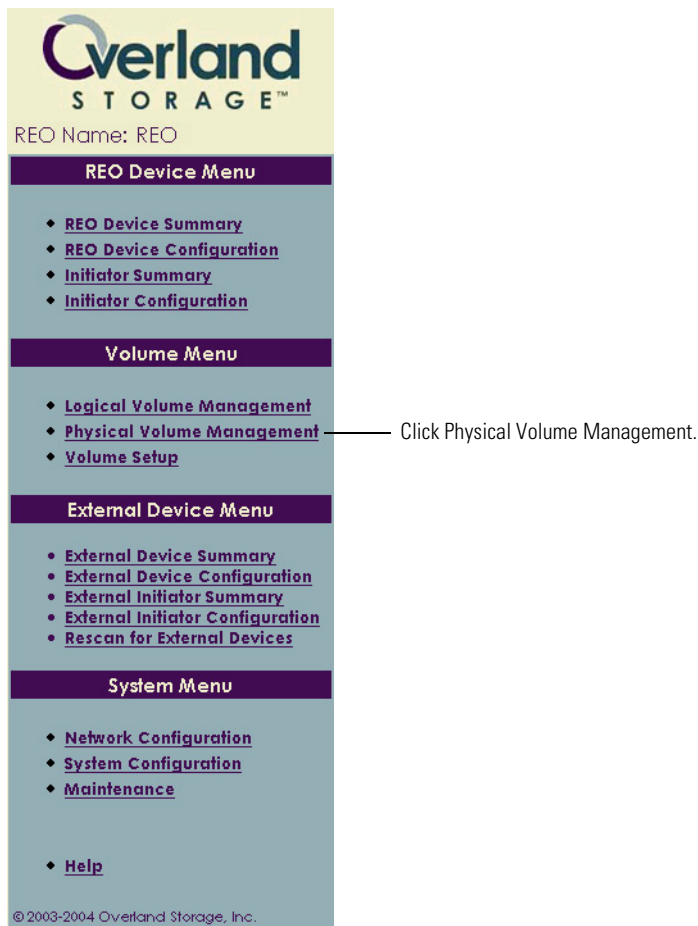

- 9 Perform the applicable steps for the volume configuration that you are using:
- If you are using a JBOD configuration, the 12 new disks are listed in the FREE DRIVE POOL. Click the **Add** button for the first new disk, and then click **OK** when the confirmation message appears. Repeat this step for each new disk.
  - If you are using a RAID 0 configuration, the new disks are listed in the FREE DRIVE POOL for the second host. Click the **Create** button that appears next to the list of new disks, and then click **OK** when the confirmation message appears. Repeat these steps until there are no disks remaining in the FREE DRIVE POOL and a Create button is no longer available. (For more information, see *Selecting a RAID Configuration* on page 65.)
  - If you are using a RAID 5 configuration, the new disks are listed in the FREE DRIVE POOL for the second host. Click the **Create** button that appears next to the list of new disks, click **OK** if you want to create a hot spare, and then click **OK** when the confirmation message appears. Repeat these steps until there are no disks remaining in the FREE DRIVE POOL and a Create button is no longer available. (For more information, see *Selecting a RAID Configuration* on page 65.)

- 10 If you are using a RAID configuration with logical volumes, use the **Logical Volume Management** page to expand the size of the existing volumes or create additional volumes.

For more information on creating logical volumes, see *Creating Logical Volumes* on page 71.



# A | Sharing Access to a REO 9000 Between Multiple Systems

## APPENDIX

The ShareDevice feature lets you share a single disk (physical or virtual) with more than one initiator. You can use this feature with any combination of iSCSI or FC initiator connections. However, only one initiator can access a single disk (physical or virtual) at a time.

**Note:** The ShareDevice feature is currently only available on Windows-based operating systems and is not supported for tape emulation. It also requires that the size of the device being shared is 400 GB or smaller.

For Windows-based initiators, the product includes a set of scripts that helps you automate the process of sharing the disks.

- **Ovlnstart.exe.** You can insert this file into the pre-processing script of the backup application to suspend operation of the backup job until the REO Appliance is ready (not in use by another server). If your pre-processing utilizes a script or batch file, make ovlnstart.exe the first executable line in the file.
- **Ovlnstop.exe.** You can insert this file into the post-processing script of the backup application to flush all data from cache and then relinquish control of the REO Appliance. If your post-processing utilizes a script or batch file, make ovlnstop.exe the first executable line in the file.

---

**Important:** If you do not use the scripts, you might experience errors (for example, “Disk not ready” or “Backup device not ready”) when an initiator attempts to access a disk that is currently being controlled by another initiator.

---

## Configuring Devices as Shared Devices

Note the following additions to the steps outlined previously in *Configuring REO Devices as Disk or Tape Devices*.

- 1 Select the **ShareDevice** check box.

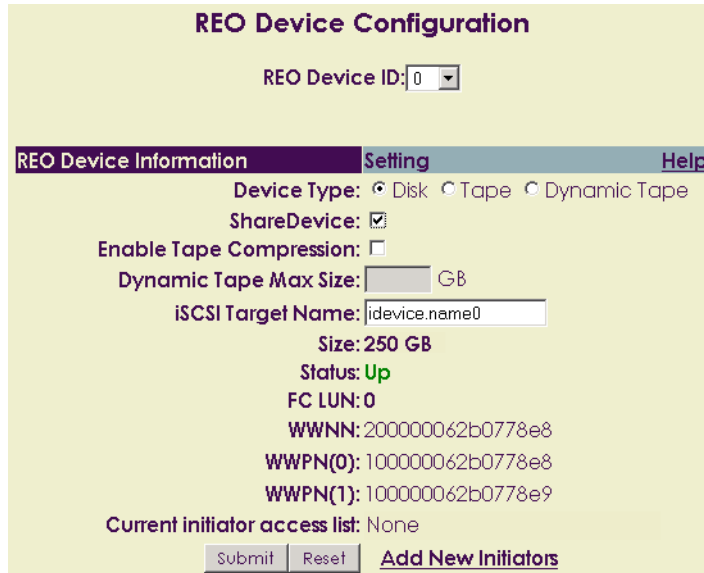

- 2 To access the folder that contains script files, which you can append to the default scripts for your backup software, do the following:
  - a Access the mapped network drive **\\REO\programs**.

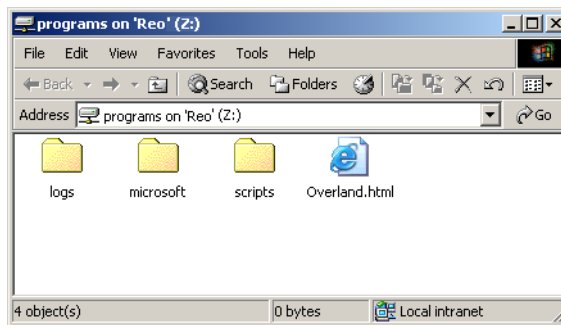

- b Open the **scripts** folder, and select the **ovlndstart.exe** and **ovlndstop.exe** files.

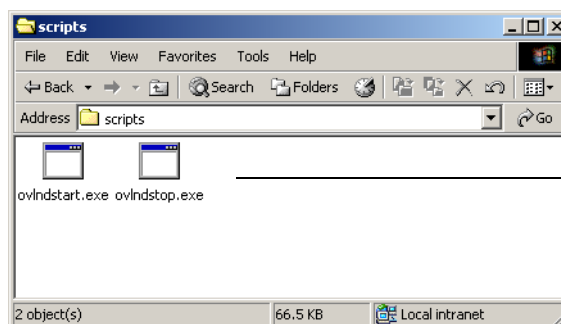

Copy these files to each applicable server.

- c Copy the files to the appropriate location (path) for your backup application (for example, C:\WINNT) folder on each server that will participate in the backup process.
- d Edit your the pre-processing script in the backup application to call **ovlndstart.exe**, and edit the post-processing script to call **ovlndstop.exe**.

You can use these scripts with any backup software agent that can run pre- and post-process scripts, with batch files that launch backup or copy operations at a later time, or with scheduling tools such as Windows AT Scheduler or WinCron.

Tip: For specific instructions related to some of the backup software products currently supported by the REO Appliance, see the applicable Application Notes on the Overland Storage Web site at: [www.overlandstorage.com](http://www.overlandstorage.com)

## Accessing a Shared Device

After you have completed configuration of the targets and initiators, the REO Appliance makes each REO Device (target) appear as a removable disk on your servers. The removable disk (REO Device) can be sequentially (but not simultaneously) accessed by multiple servers. If the removable disk is available (no activity for approximately five minutes), it can be accessed by either one of the initiators.

- To expedite the process of making the removable disk available, right-click its icon, and select **Eject**.

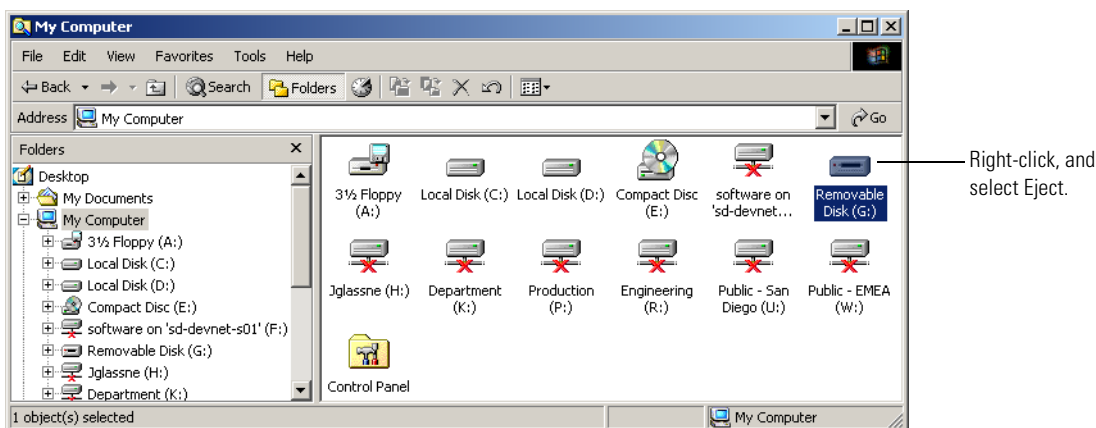





# B Basic Troubleshooting

## APPENDIX

As you troubleshoot the REO Appliance, keep the following guidelines in mind:

- Do not turn off the REO Appliance using the power button on the appliance. You must verify that none of the initiators have active connections, and you should use the Shutdown/Restart option in the software console to power down the REO Appliance.
- Never remove the chassis cover.
- If a peripheral does not work, make sure that all connections are secure.

## Using the SoftKey Reset Option

Use this option, which is available via the System Maintenance page, only when you are instructed to do so by Overland Storage Technical Support.

**Important:** If you click Reset, your network- and system-configuration settings will be returned to the factory defaults.

**SoftKey Default Settings** [Help](#)

This option will reset the SoftKey back to default settings.  
It will NOT destroy the currently configured volumes, logical or physical.

**The REO Appliance SHUTS DOWN Immediately!**

It will be unavailable until the SoftKey is reconfigured and the REO Appliance is powered back on.

## Sending the Log Files to Technical Support

The REO Appliance creates and maintains log files that contain diagnostic information intended for use by Overland Storage Technical Support in troubleshooting issues you might encounter. The logs are updated every 60 seconds, with new information appended to the beginning of the applicable file. When the maximum log-file size is reached, previous information is deleted so that new information can be added.

### To locate the logs (if requested by Technical Support)

- 1 Access the mapped network drive `\\REO\programs`, and open the **logs** folder.

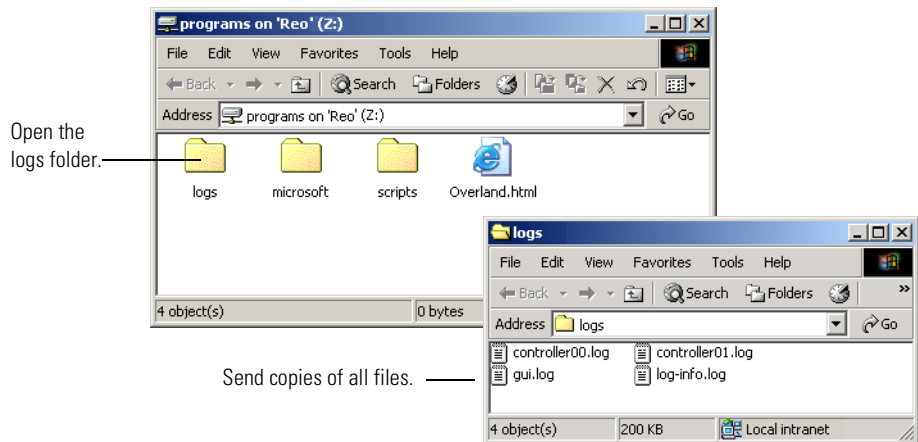

- 2 Use your e-mail application to forward copies of the files to: [support@overlandstorage.com](mailto:support@overlandstorage.com).

**Tip:** If the files are significant in size, consider using an application such as WinZip to compress the logs folder and send the compressed version of the folder instead.

## Unable to Access the REO Appliance

If you cannot access the REO Appliance through the console or through the Data Ports, try the following:

- 1 Check the LED lights on the REO Appliance.  
If lights are not on, check all connections between the REO Appliance and the power source.
- 2 Make sure that all applicable IP addresses are correct.
- 3 Make sure the network cables are properly installed.

The network cables must be securely attached at all connections. If the cables appear to be properly attached but the problem persists, try different cables.



## REO Appliance Does Not Start

If DHCP is not operational on your LAN, you must manually edit the configuration file on the REO SoftKey before you connect it to the REO Appliance and start it. If you already edited the configuration file or if your LAN uses DHCP and the REO Appliance is beeping repeatedly, it might be because a LAN cable is not connected to the Management Port, the REO SoftKey is not inserted, the key is not inserted correctly, the key is damaged, the copy-protection file on the key is invalid, or the wrong key was used.

### To determine why the appliance does not start

- ▶ Choose one of the following:
  - If your LAN does *not* use DHCP and you have not edited the configuration file on the key, perform the steps outlined under *Editing the Configuration File (for a non-DHCP or UNIX Management System)* on page 33.
  - If your LAN uses DHCP or if you already edited the configuration file, do the following:
    - Use the software console to restart the REO Appliance. For more information, see *Powering Down the REO Appliance* on page 105.
    - If you want a cable connected to the Management Port, make sure that you are using the applicable type of cable and that a DHCP server is available (if the Management Port is configured for DHCP, it will not complete the startup process until a system with DHCP is located). Otherwise, disconnect the cable from the Management Port.
    - Make sure that you are using the correct key (for example, if you purchased more than one unit, you might have mixed up the keys).
    - Make sure that the key is functional by inserting it into a USB port on your management system and verifying that you can view the contents.
    - If these steps do not solve the problem, contact Customer Support at Overland Storage. For contact information, see *Customer Support* on page 159.

## Unable to Log On to the Console

If you are unable to log on to the REO Appliance console, it might be because you are using Internet Explorer and the privacy setting is set above Medium (the console is a Web-enabled program that requires the use of cookies; setting the privacy option higher than Medium prevents the program from working correctly), it might be because you are entering the name and password incorrectly, or it might be because you are using the wrong REO SoftKey.

- 1 If you receive a message similar to the following, replace the key currently inserted in the appliance with the correct key.

This message indicates that you have inserted a key that is using software version 2.2 or later into an appliance that is currently configured to use software version 2.1 or earlier. For instructions on upgrading the appliance, see the applicable release notes posted on the Web site at [www.overlandstorage.com](http://www.overlandstorage.com).



- 2 Make sure that you are entering the name and password correctly; they are case-sensitive.

The console uses the following defaults for the name and password:

Name: Administrator

Password: system

- 3 If you changed the default name or password and subsequently forget the new information, perform the steps outlined under *I Forgot the New Password or Logon Name* on page 128 to locate the required information.
- 4 If you are unable to access the console in Internet Explorer running on any version of Windows other than Windows Server 2003, do the following (if you are using Windows Server 2003, perform the steps outlined in the next section, *Internet Explorer Does Not Redirect from IP Address on Windows Server 2003*):
  - a Launch **Internet Explorer**.
  - b In the **Tools** menu, click **Internet Options**.
  - c On the **Privacy** tab, move the slider to **Medium** (or lower).
  - d To save your changes, click **OK**.

## Internet Explorer Does Not Redirect from IP Address on Windows Server 2003

If you access the REO Appliance console using Internet Explorer running on Windows Server 2003, you might see a blank screen after you enter a valid IP address for the REO Appliance to which you are trying to connect.

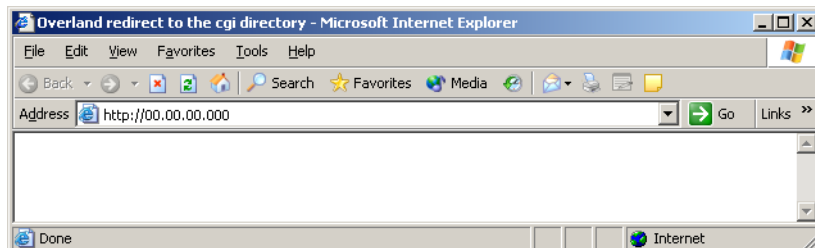

This happens because Internet Explorer has an enhanced security configuration that is enabled by default in Windows Server 2003. This setting does not allow the server to redirect the IP address to the correct location. To prevent this from occurring, you need to add the IP address for the REO Appliance to the list of trusted sites for this server.

### To add the REO Appliance to the list of trusted sites

- 1 Launch **Internet Explorer**.
- 2 In the **Tools** menu, click **Internet Options**.
- 3 On the **Security** tab, select **Trusted Sites**, and then click **Sites**.

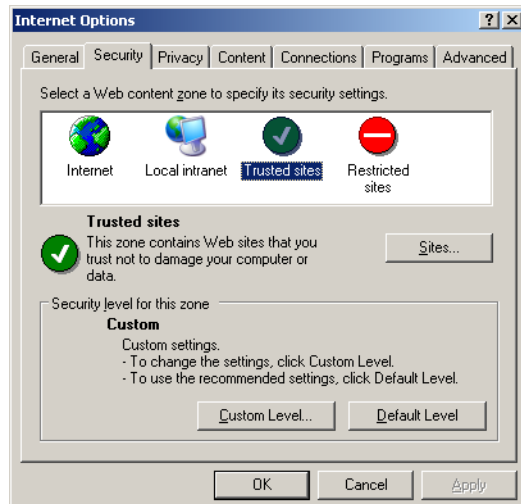

- 4 In the **Add this Web site to the zone** box, type the IP address for the REO Appliance, and click **Add**.

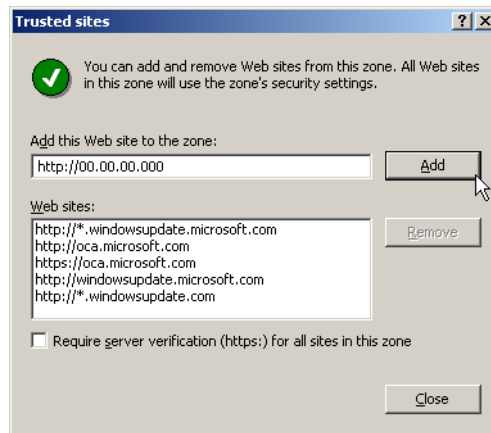

- 5 To dismiss the **Trusted sites** dialog box, click **Close**, and then click **OK** to save your changes and close the **Internet Options** dialog box.
- 6 In the browser window, try accessing the console for the REO Appliance again.

The log on window should appear.

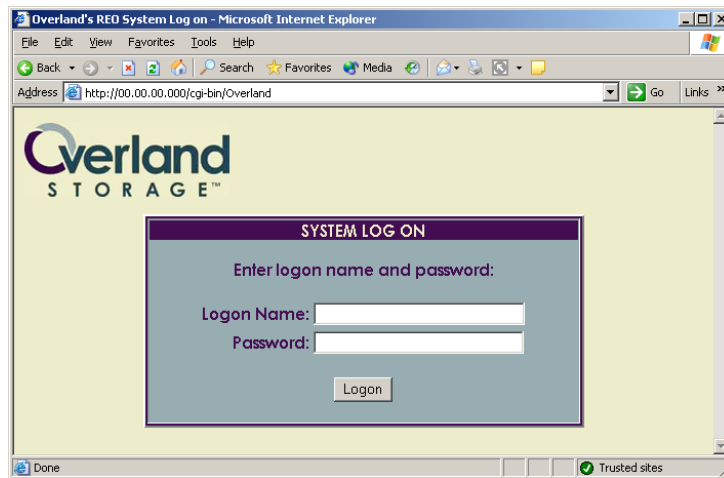

## Browser Does Not Reflect Changes Made from Another System or Browser Window

If you have multiple browser windows open that are pointing to the same REO Appliance, changes that you make from one browser window will not display in another (second) browser window until you log out of the second window and log back on. This occurs whether the second browser window is open on the same system or on a different system.

- ▶ To view updates, exit the browser, open the browser, and log back on.

## Unable to Connect to the Disks via Windows Explorer

If you are unable to access the disks on the REO Appliance, it might be because the system or a disk on the appliance is malfunctioning, because the disks were reformatted using a file system other than NTFS, or because the disks are not formatted.

- 1 Make sure that the REO Appliance is turned on and that all cables are correctly connected.
- 2 Make sure that you can view other disks from the same initiator.  
If not, there might be a problem with a cable or the Ethernet connection.
- 3 Make sure that you can view the targets (REO Devices) from the initiator.
  - a Log on to the software console.
  - b In the left pane, under **Volume Menu**, click **Physical Volume Management**.

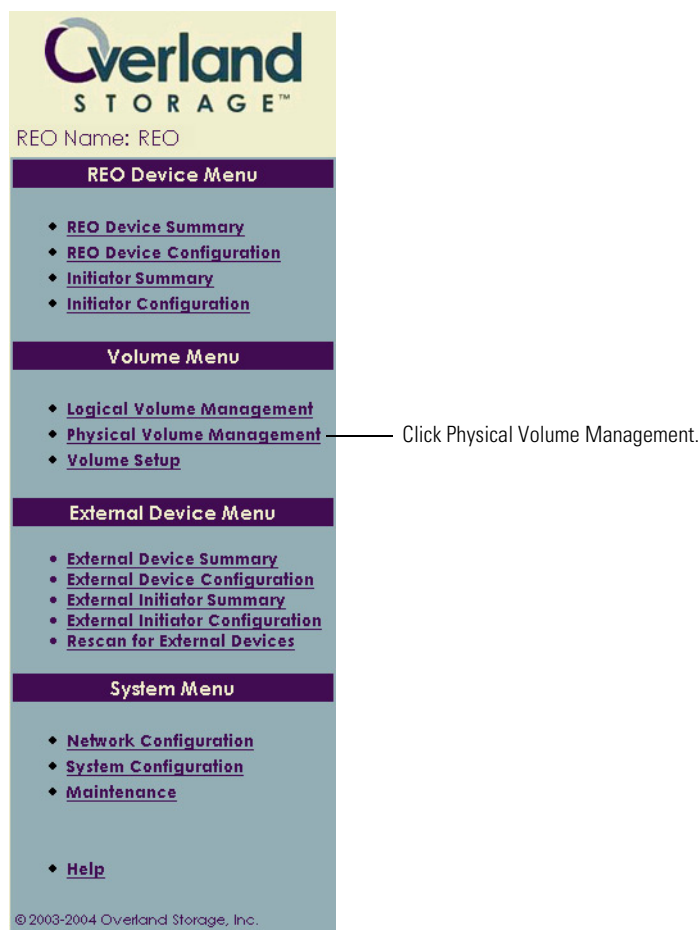

- c Verify that the **Status** of each volume and disk is **OK**, which indicates that the target is functioning correctly.

- d Check the ALARM MESSAGES section to see if there are any alerts regarding the disks. These messages (also known as asynchronous event notifications) display additional information about each disk that might not be displayed in an alert e-mail.

Physical Volume Management	
<a href="#">Help</a>	
<b>Host: 1 Information</b>	
RAID0:PU:00 - SCSI ID: 0 Size: 1599 GB	
Status:	OK
Disk: 0	Status: OK
Disk: 1	Status: OK
Disk: 2	Status: OK
Disk: 3	Status: OK
RAID0:PU:01 - SCSI ID: 1 Size: 1599 GB	
Status:	OK
Disk: 4	Status: OK
Disk: 5	Status: OK
Disk: 6	Status: OK
Disk: 7	Status: OK
RAID0:PU:02 - SCSI ID: 2 Size: 1599 GB	
Status:	OK
Disk: 8	Status: OK
Disk: 9	Status: OK
Disk: 10	Status: OK
Disk: 11	Status: OK
FREE DRIVE POOL - SCSI ID: 99 Size: 0 GB	
Status:	EMPTY
ALARM MESSAGES:	
<b>Host: 2 Information</b>	
RAID0:PU:12 - SCSI ID: 0 Size: 1599 GB	
Status:	OK
Disk: 12	Status: OK
Disk: 13	Status: OK
Disk: 14	Status: OK
Disk: 15	Status: OK
RAID0:PU:13 - SCSI ID: 1 Size: 1599 GB	
Status:	OK
Disk: 16	Status: OK
Disk: 17	Status: OK
Disk: 18	Status: OK
Disk: 19	Status: OK
RAID0:PU:14 - SCSI ID: 2 Size: 1599 GB	
Status:	OK
Disk: 20	Status: OK
Disk: 21	Status: OK
Disk: 22	Status: OK
Disk: 23	Status: OK
FREE DRIVE POOL - SCSI ID: 99 Size: 0 GB	
Status:	EMPTY
ALARM MESSAGES:	

Make sure that the Status of each volume and disk is OK.

- 4 If you are trying to view the disks from a Windows NT system, make sure that the disks are formatted as NTFS volumes.

The disks are factory-formatted using NTFS 4. If you reformat the disks as another type of file system (such as FAT or FAT32), you will not be able to access the disks using Windows NT. If you are able to view the disks from Windows 2000 or 2003, but not from Windows NT, it indicates that the disks are not NTFS.

**Tip:** To double-check the file-system property, on a Windows 2000 or 2003 system, right-click the disk, click Properties, and note the File system designation on the General tab.

## Perpetual Loop of Audio Alerts

On startup, the REO Appliance might reach an error state and begin an endless loop of alerts. The pattern (2 beeps separated by a 1-second delay) repeats every 4 seconds.

- ▶ If the REO Appliance reaches this error state, turn the REO Appliance off and then back on.

The cause of this error state might also be one of the following:

- A LAN cable is not connected to the Management Port.
- The REO SoftKey is not inserted, is not inserted correctly, or is physically damaged.
- The wrong REO SoftKey was used (you inserted the wrong key).

## Disabling the Audio Alarm

If a power supply or fan fails or detects an issue with the appliance, an audible alarm sounds. If you do not have the spare component needed to correct the situation (for example, if you need to replace a power supply), press the small, red button on the back of the appliance to turn off the sound temporarily (after you correct the situation, make sure that you press the button again to engage the audio feature).

## Systems Restart When I Map a Disk Drive

If your systems restart whenever you try to map a disk, it indicates that your LAN does not use DHCP, and you did not manually edit the configuration file located on the REO SoftKey before continuing with the configuration process.

- ▶ If your LAN does *not* use DHCP and you have not edited the configuration file on the key, perform the steps outlined under *Editing the Configuration File (for a non-DHCP or UNIX Management System)* on page 33.

## I Forgot the New Password or Logon Name

If you change the default name and password that you use to log on to the console and subsequently forget the new information, use the following steps to locate the required information.

- 1 Make sure that you are entering the name and password correctly; they are *case-sensitive*.

The default name is Administrator, and the default password is system.

- 2 Using a text editor, open the **login** file located in the `<drive>:\var\Overland` folder on the REO SoftKey.

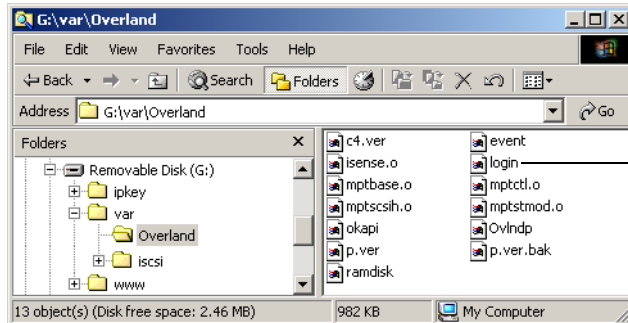

- 3 Search for the line with **UserName** and **Password**, and note the corresponding information.

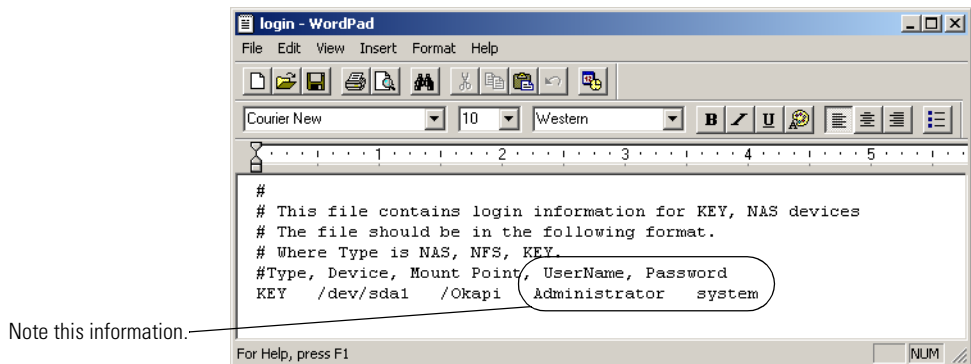

**Important:** Do not use this file to modify the name or password information.



## Lost or Damaged REO SoftKey or Files Accidentally Deleted from the Key

The REO SoftKey contains the software and settings required for configuring the REO Appliance that you purchased (note that if you purchased multiple units, the keys are not interchangeable). If you lose or damage this key, you cannot restart or reconfigure your REO Appliance.

---

**Important:** If you purchased multiple units, note that the keys are *not* interchangeable.

---

- 1 Note the serial number of your REO Appliance, which is located on the exterior of the appliance.
- 2 Contact Customer Support at Overland Storage.  
For contact information, see *Customer Support* on page 159.

## Determining Whether a Disk Drive is Faulty or There is a Problem with the REO Appliance

When there is a problem with a disk drive, its Status on the Physical Volume Management page is reported on as NOT PRESENT, and the disk moves to the FREE DRIVE POOL section (if you are using RAID 0, all associated disks in the applicable volume also move to the FREE DRIVE POOL section). The first step you can take is to force an addition of the disk (JBOD only), re-creation of the volume that contains the disk drive in question (RAID 0), rebuild of the volume that contains the disk drive in question (RAID 5 without hot spares), or re-creation of a hot spare (RAID 5 with hot spares). The next step is to replace the applicable disk with a spare disk.

### Forcing an Add (JBOD)

- 1 Make sure that none of the initiators (servers) have active connections with the REO Appliance.  
For example, in the iSCSI Initiator Properties dialog box for the Microsoft initiator, you can check the Active Sessions tab to determine if there is a connection that needs to be terminated.

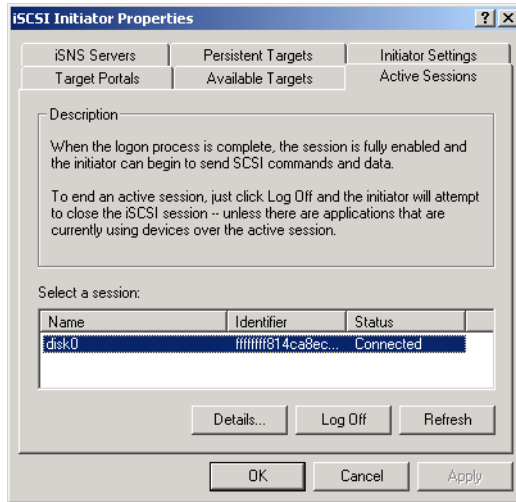

- 2 Log on to the software console.
- 3 In the left pane, under **Volume Menu**, click **Physical Volume Management**.

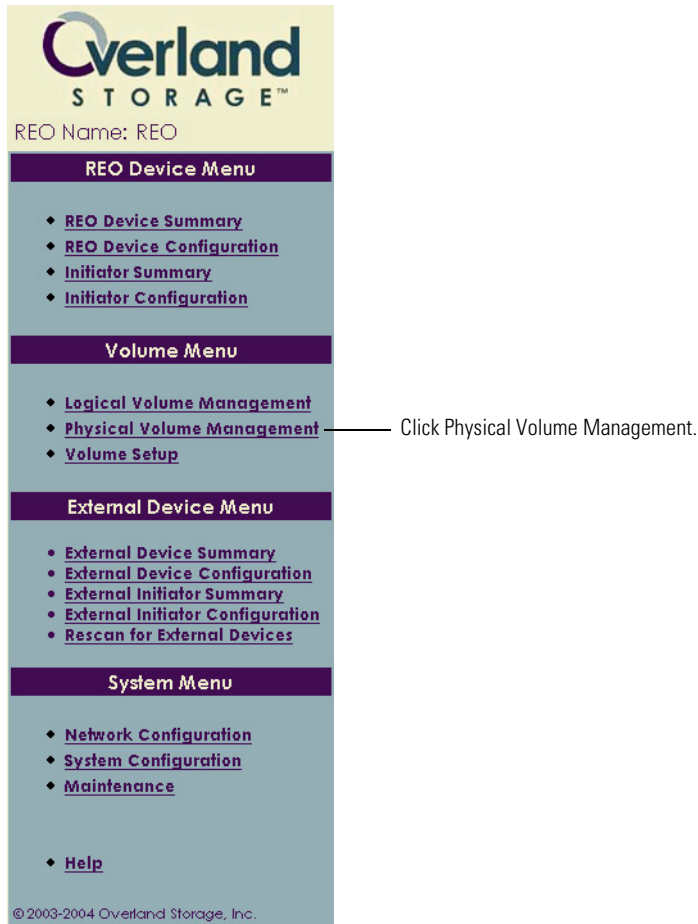

- 4 In the **Physical Volume Management** page, click the **Add** button next to the disk drive whose **Status** is **NOT PRESENT**.

When a disk is unavailable, it appears in the FREE DRIVE POOL section of the page.

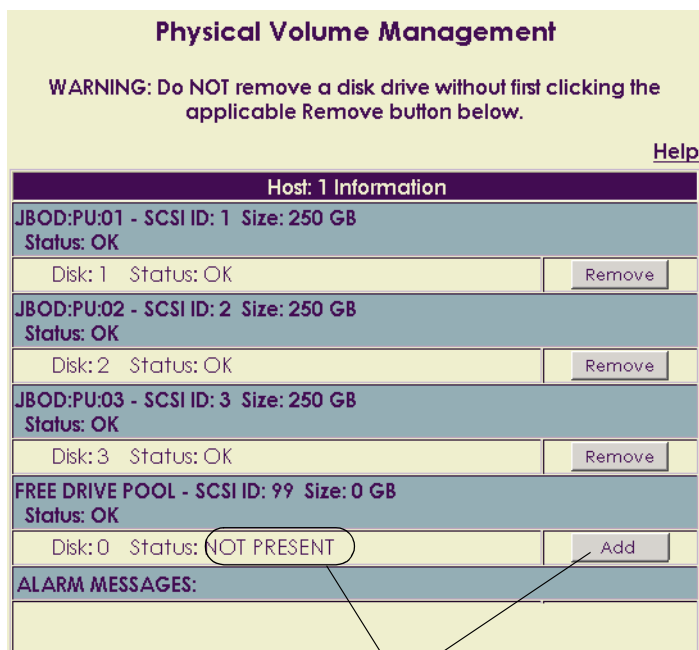

For the disk whose Status is NOT PRESENT, click Add.

- 5 When the confirmation message appears, click **OK**.

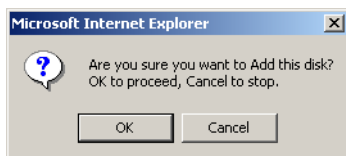

- 6 Note whether the **Status** of the specific disk drive changes to **OK**.
- If the disk drive is recovered, the disk returns to its position in the list (that is, it no longer appears in the FREE DRIVE POOL section), the **Status** changes to **OK**, and you can resume normal operations with the REO Appliance.
  - If the disk drive cannot be recovered, the following message appears.

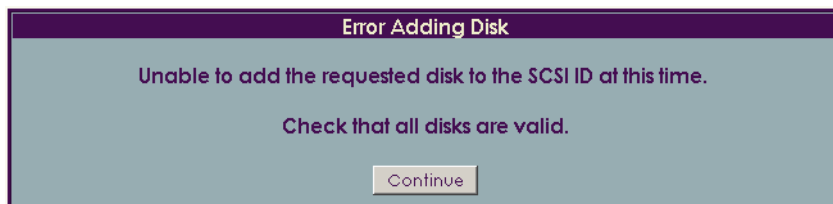

If this message appears, replace the applicable disk with a spare disk (for more information, see *Purchasing a Spare Disk Drive* on page 144). If the REO Appliance continues to report a problem after you replace the disk, contact Overland Storage Technical Support (for more information, see *Customer Support* on page 159).

## Re-Creating a RAID 0 Volume

- 1 Make sure that none of the initiators (servers) have active connections with the REO Appliance.

For example, in the iSCSI Initiator Properties dialog box for the Microsoft initiator, you can check the Active Sessions tab to determine if there is a connection that needs to be terminated.

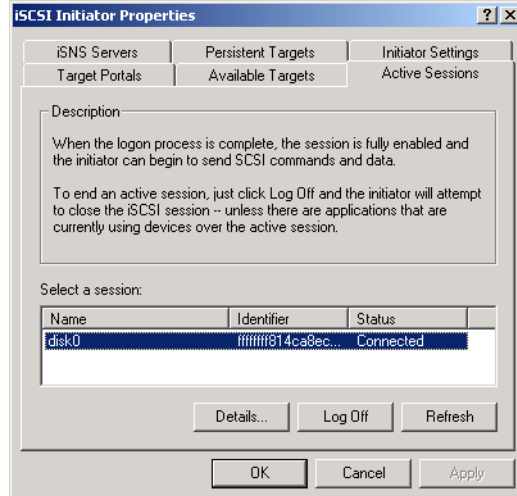

- 2 Log on to the software console.

- 3 In the left pane, under **Volume Menu**, click **Physical Volume Management**.

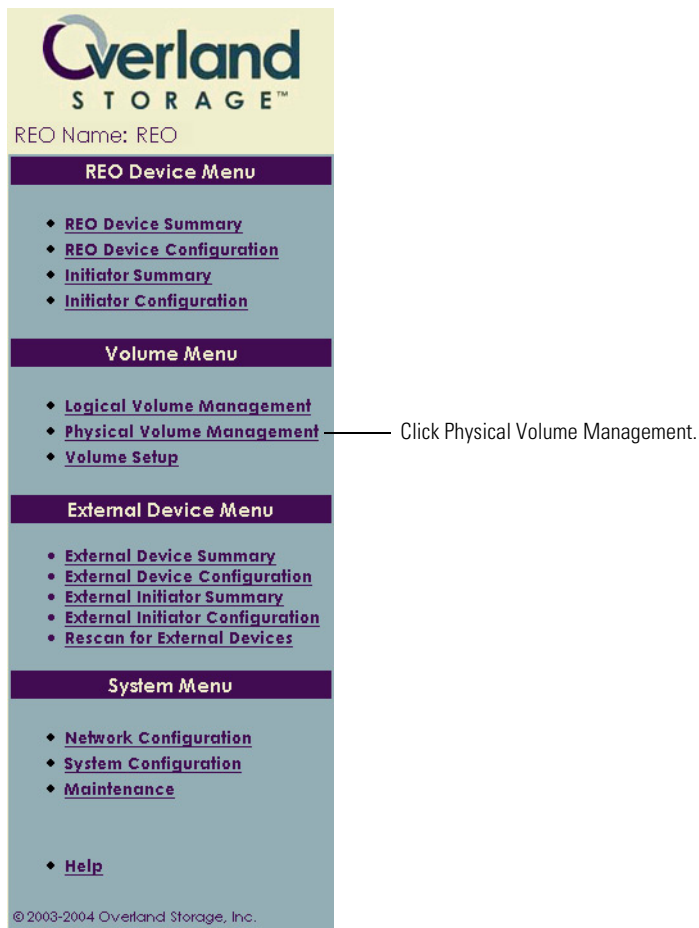

- 4 In the **Physical Volume Management** page, click the **Create** button for the set of disks currently in the **FREE DRIVE POOL** section.

Physical Volume Management		<a href="#">Help</a>
<b>Host: 1 Information</b>		
RAID0:PU:00 - SCSI ID: 0 Size: 1599 GB Status: OK		
Disk: 4	Status: OK	
Disk: 5	Status: OK	
Disk: 6	Status: OK	
Disk: 7	Status: OK	
RAID0:PU:01 - SCSI ID: 1 Size: 1599 GB Status: OK		
Disk: 8	Status: OK	
Disk: 9	Status: OK	
Disk: 10	Status: OK	
Disk: 11	Status: OK	
FREE DRIVE POOL - SCSI ID: 99 Size: 0 GB Status: OK	<b>Create</b>	Click Create.
Disk: 0	Status: NOT PRESENT	
Disk: 1	Status: OK	
Disk: 2	Status: OK	
Disk: 3	Status: OK	
<b>ALARM MESSAGES:</b>		
[Thu Oct 21 10:47:33 2004] (0x04:0x000A): Drive error detected: , disk=23		

- 5 When the confirmation message appears, click **OK**.

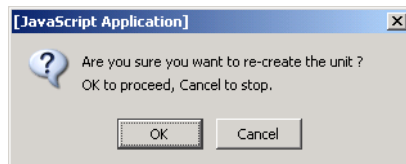

The system tries to re-create the volume using the disks that are currently in the FREE DRIVE POOL section. The process will either succeed or fail.

- If the process succeeds, the volume is re-created. If the Status is OK, you can resume normal operations with the REO Appliance.

Physical Volume Management	
<a href="#">Help</a>	
Host: 1 Information	
RAID0:PU:00 - SCSI ID: 0 Size: 1599 GB	
Status: OK	
Disk: 0	Status: OK
Disk: 1	Status: OK
Disk: 2	Status: OK
Disk: 3	Status: OK
RAID0:PU:01 - SCSI ID: 1 Size: 1599 GB	
Status: OK	
Disk: 4	Status: OK
Disk: 5	Status: OK
Disk: 6	Status: OK
Disk: 7	Status: OK
RAID0:PU:02 - SCSI ID: 2 Size: 1599 GB	
Status: OK	
Disk: 8	Status: OK
Disk: 9	Status: OK
Disk: 10	Status: OK
Disk: 11	Status: OK
FREE DRIVE POOL - SCSI ID: 99 Size: 0 GB	
Status: EMPTY	
ALARM MESSAGES:	

- If the process fails, an error message appears, and the disks remain in the FREE DRIVE POOL section. You must replace the applicable disk. For more information, see *Purchasing a Spare Disk Drive*. If the REO Appliance continues to report a problem after you replace the disk, contact Overland Storage Technical Support (for more information, see *Customer Support* on page 159).



## Rebuilding a Volume (RAID 5 Without Hot Spare)

When an issue arises with a disk in a RAID 5 configuration, the disk in question moves to the FREE DRIVE POOL section and the volume has a Status of DEGRADED.

**Physical Volume Management**

**WARNING: Do NOT remove a disk drive without first clicking the applicable Remove button below.**

[Help](#)

Host: 1 Information	
<b>RAID5:PU:00 - SCSI ID: 0 Size: 1999 GB</b> Status: <b>DEGRADED</b>	<input type="button" value="Rebuild"/>
Disk: 1 Status: OK	
Disk: 2 Status: OK	
Disk: 3 Status: OK	
Disk: 4 Status: OK	
Disk: 5 Status: OK	
<b>RAID5:PU:01 - SCSI ID: 1 Size: 1999 GB</b> Status: <b>OK</b>	<input type="button" value="Verify"/>
Disk: 6 Status: OK	<input type="button" value="Remove"/>
Disk: 7 Status: OK	<input type="button" value="Remove"/>
Disk: 8 Status: OK	<input type="button" value="Remove"/>
Disk: 9 Status: OK	<input type="button" value="Remove"/>
Disk: 10 Status: OK	<input type="button" value="Remove"/>
Disk: 11 Status: OK	<input type="button" value="Remove"/>
<b>FREE DRIVE POOL - SCSI ID: 99 Size: 0 GB</b> Status: <b>OK</b>	
Disk: 0 Status: NOT PRESENT	
<b>ALARM MESSAGES:</b>	
[Thu Oct 21 10:47:33 2004] (0x04:0x000A): Drive error detected: , disk=0	

The volume is placed in a degraded state.

The disk with an issue moves here.

### To test the disk by forcing a rebuild

- 1 Make sure that none of the initiators (servers) have active connections with the REO Appliance.



For example, in the iSCSI Initiator Properties dialog box for the Microsoft initiator, you can check the Active Sessions tab to determine if there is a connection that needs to be terminated.

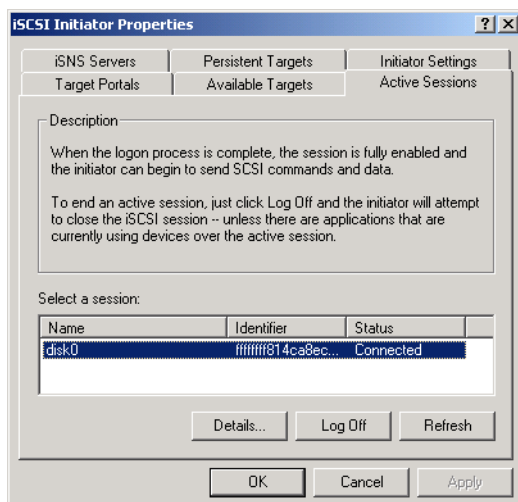

- 2 Log on to the software console.
- 3 In the left pane, under **Volume Menu**, click **Physical Volume Management**.

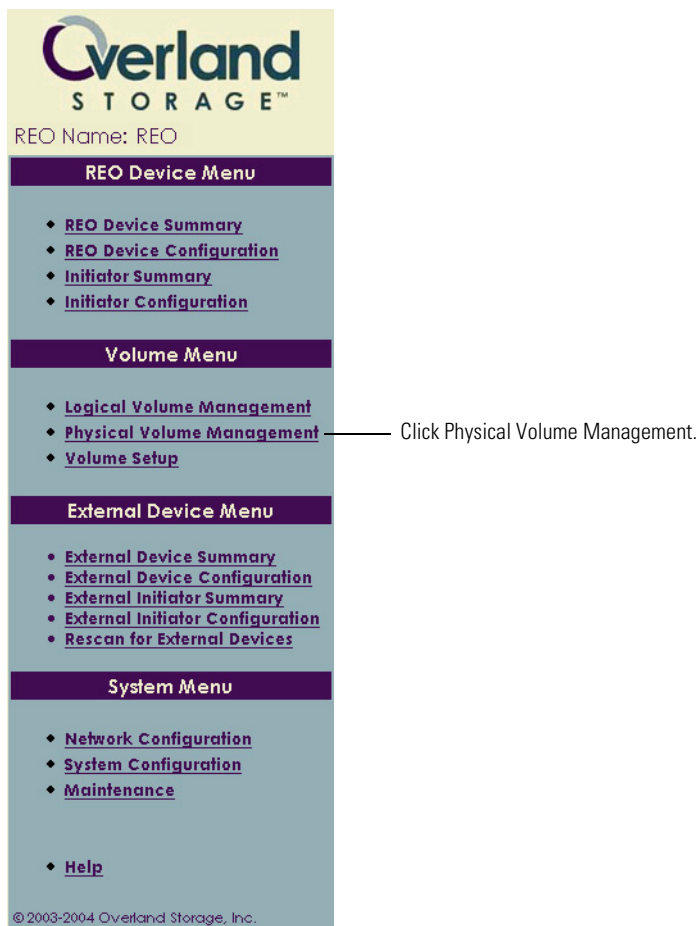

- 4 In the **Physical Volume Management** page, click the **Rebuild** button for the volume whose **Status** is **DEGRADED**.

**Physical Volume Management**

**WARNING: Do NOT remove a disk drive without first clicking the applicable Remove button below.**

[Help](#)

Host: 1 Information	
<b>RAID5:PU:00 - SCSI ID: 0 Size: 1999 GB</b> <b>Status: DEGRADED</b>	<input type="button" value="Rebuild"/>
Disk: 1 Status: OK	
Disk: 2 Status: OK	
Disk: 3 Status: OK	
Disk: 4 Status: OK	
Disk: 5 Status: OK	
<b>RAID5:PU:01 - SCSI ID: 1 Size: 1999 GB</b> <b>Status: OK</b>	<input type="button" value="Verify"/>
Disk: 6 Status: OK	<input type="button" value="Remove"/>
Disk: 7 Status: OK	<input type="button" value="Remove"/>
Disk: 8 Status: OK	<input type="button" value="Remove"/>
Disk: 9 Status: OK	<input type="button" value="Remove"/>
Disk: 10 Status: OK	<input type="button" value="Remove"/>
Disk: 11 Status: OK	<input type="button" value="Remove"/>
<b>FREE DRIVE POOL - SCSI ID: 99 Size: 0 GB</b> <b>Status: OK</b>	
Disk: 0 Status: NOT PRESENT	
<b>ALARM MESSAGES:</b>	
[Thu Oct 21 10:47:33 2004] (0x04:0x000A): Drive error detected: , disk=0	

For the volume whose Status is DEGRADED, click Rebuild.

- 5 When the confirmation message appears, click **OK**.

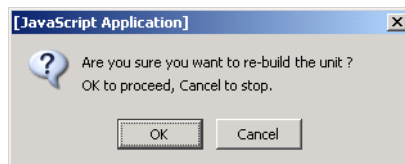

The system tries to use the disk that is currently in the FREE DRIVE POOL section to rebuild the volume. While in work, the Status of the volume is REBUILDING. The process will either succeed or fail.

**Physical Volume Management**

**WARNING: Do NOT remove a disk drive without first clicking the applicable Remove button below.**

[Help](#)

Host: 1 Information	
<b>RAID5:PU:00 - SCSI ID: 0 Size: 1999 GB</b>	
<b>Status: REBUILDING (2%)</b>	
Disk: 0	Status: OK
Disk: 1	Status: OK
Disk: 2	Status: OK
Disk: 3	Status: OK
Disk: 4	Status: OK
Disk: 5	Status: OK
<b>RAID5:PU:01 - SCSI ID: 1 Size: 1999 GB</b>	
<b>Status: OK</b>	
<input type="button" value="Verify"/>	
Disk: 6	Status: OK <input type="button" value="Remove"/>
Disk: 7	Status: OK <input type="button" value="Remove"/>
Disk: 8	Status: OK <input type="button" value="Remove"/>
Disk: 9	Status: OK <input type="button" value="Remove"/>
Disk: 10	Status: OK <input type="button" value="Remove"/>
Disk: 11	Status: OK <input type="button" value="Remove"/>
<b>FREE DRIVE POOL - SCSI ID: 99 Size: 0 GB</b>	
<b>Status: EMPTY</b>	
<b>ALARM MESSAGES:</b>	

- If the process succeeds, the disk returns to the volume, the Status is OK, and REMOVE buttons become available for the disks. If the Status is OK, you can resume normal operations with the REO Appliance. If you want to ensure the integrity of the volume and the redundancy of the data, click **Verify**.

**Physical Volume Management**

**WARNING: Do NOT remove a disk drive without first clicking the applicable Remove button below.**

[Help](#)

Host: 1 Information		
<b>RAID5:PU:00 - SCSI ID: 0 Size: 1999 GB</b>		<input type="button" value="Verify"/>
Status: OK		
Disk: 0 Status: OK	<input type="button" value="Remove"/>	
Disk: 1 Status: OK	<input type="button" value="Remove"/>	
Disk: 2 Status: OK	<input type="button" value="Remove"/>	
Disk: 3 Status: OK	<input type="button" value="Remove"/>	
Disk: 4 Status: OK	<input type="button" value="Remove"/>	
Disk: 5 Status: OK	<input type="button" value="Remove"/>	
<b>RAID5:PU:01 - SCSI ID: 1 Size: 1999 GB</b>		<input type="button" value="Verify"/>
Status: OK		
Disk: 6 Status: OK	<input type="button" value="Remove"/>	
Disk: 7 Status: OK	<input type="button" value="Remove"/>	
Disk: 8 Status: OK	<input type="button" value="Remove"/>	
Disk: 9 Status: OK	<input type="button" value="Remove"/>	
Disk: 10 Status: OK	<input type="button" value="Remove"/>	
Disk: 11 Status: OK	<input type="button" value="Remove"/>	
<b>FREE DRIVE POOL - SCSI ID: 99 Size: 0 GB</b>		
Status: EMPTY		
<b>ALARM MESSAGES:</b>		

- If the process fails, an error message appears, and the disk remains in the FREE DRIVE POOL section. You must replace the applicable disk. For more information, see *Purchasing a Spare Disk Drive*. If the REO Appliance continues to report a problem after you replace the disk, contact Overland Storage Technical Support (for more information, see *Customer Support* on page 159).

**SCSI ID Creation Error**

Unable to create the requested SCSI ID at this time.

Verify that all disks are valid.

## Re-Creating a Hot Spare (RAID 5 With Hot Spares)

When an issue arises with a disk in a RAID 5 configuration and you are using hot spares, the disk in question moves to the FREE DRIVE POOL section, and the system automatically begins a rebuild process by using the disk initially designated as a hot spare.

The questionable disk remains in the FREE DRIVE POOL section and is assigned a Hot Spare button. To determine if the questionable disk needs to be replaced, you can use it to re-create a hot spare. If process fails, you must replace the disk.

**Physical Volume Management**

**WARNING: Do NOT remove a disk drive without first clicking the applicable Remove button below.**

[Help](#)

Host: 1 Information		
<b>RAID5:PU:01 - SCSI ID: 1 Size: 1599 GB</b>		
<b>Status: REBUILDING (0%)</b>		
Disk: 0	Status: OK	
Disk: 2	Status: OK	
Disk: 3	Status: OK	
Disk: 4	Status: OK	
Disk: 5	Status: OK	
<b>RAID5:PU:02 - SCSI ID: 2 Size: 1999 GB</b>		<b>Verify</b>
<b>Status: OK</b>		
Disk: 6	Status: OK	Remove
Disk: 7	Status: OK	Remove
Disk: 8	Status: OK	Remove
Disk: 9	Status: OK	Remove
Disk: 10	Status: OK	Remove
Disk: 11	Status: OK	Remove
<b>FREE DRIVE POOL - SCSI ID: 99 Size: 0 GB</b>		
<b>Status: OK</b>		
Disk: 1	Status: NOT PRESENT	Hot Spare
<b>ALARM MESSAGES:</b>		
[Thu Oct 21 10:47:33 2004] (0x04:0x000A): Drive error detected: , disk=1		

A rebuild begins with the hot spare replacing the questionable disk.

This disk displays a Hot Spare button.

### To test the disk by creating a hot spare

- 1 Make sure that none of the initiators (servers) have active connections with the REO Appliance.

For example, in the iSCSI Initiator Properties dialog box for the Microsoft initiator, you can check the Active Sessions tab to determine if there is a connection that needs to be terminated.

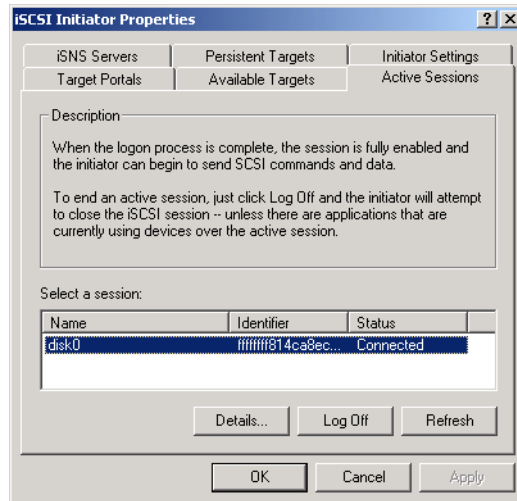

- 2 Log on to the software console.
- 3 In the left pane, under **Volume Menu**, click **Physical Volume Management**.

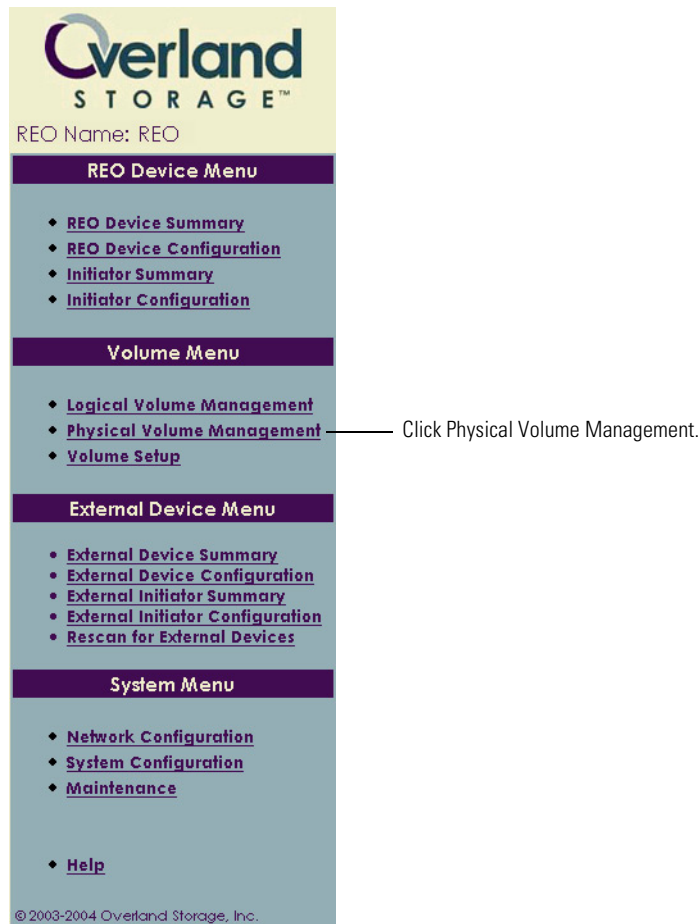

- 4 In the **Physical Volume Management** page, click the **Hot Spare** button next to the disk in the **FREE DRIVE POOL** section.

**Physical Volume Management**

**WARNING: Do NOT remove a disk drive without first clicking the applicable Remove button below.**

[Help](#)

Host: 1 Information		
<b>RAID5:PU:01 - SCSI ID: 1 Size: 1599 GB</b>		
Status: REBUILDING (0%)		
Disk: 0	Status: OK	
Disk: 2	Status: OK	
Disk: 3	Status: OK	
Disk: 4	Status: OK	
Disk: 5	Status: OK	
<b>RAID5:PU:02 - SCSI ID: 2 Size: 1999 GB</b>		<input type="button" value="Verify"/>
Status: OK		
Disk: 6	Status: OK	<input type="button" value="Remove"/>
Disk: 7	Status: OK	<input type="button" value="Remove"/>
Disk: 8	Status: OK	<input type="button" value="Remove"/>
Disk: 9	Status: OK	<input type="button" value="Remove"/>
Disk: 10	Status: OK	<input type="button" value="Remove"/>
Disk: 11	Status: OK	<input type="button" value="Remove"/>
<b>FREE DRIVE POOL - SCSI ID: 99 Size: 0 GB</b>		
Status: OK		
Disk: 1	Status: NOT PRESENT	<input type="button" value="Hot Spare"/>
<b>ALARM MESSAGES:</b>		
[Thu Oct 21 10:47:33 2004] (0x04:0x000A): Drive error detected: . disk=1		

Click Hot Spare.

- 5 When the confirmation message appears, click **OK**.

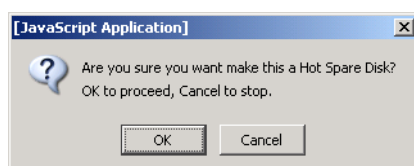

The process will either succeed or fail.

- If the process succeeds, the disk moves from the FREE DRIVE POOL section to the HOT SPARE section.

**Physical Volume Management**

**WARNING: Do NOT remove a disk drive without first clicking the applicable Remove button below.**

[Help](#)

Host: 1 Information		
<b>HOT SPARE - SCSI ID: 0 Size: 400 GB</b>		
Status: OK		
Disk: 1 Status: OK	<input type="button" value="Remove"/>	
<b>RAID5:PU:01 - SCSI ID: 1 Size: 1599 GB</b>		
Status: REBUILDING (9%)		
Disk: 0 Status: OK		
Disk: 2 Status: OK		
Disk: 3 Status: OK		
Disk: 4 Status: OK		
Disk: 5 Status: OK		
<b>RAID5:PU:02 - SCSI ID: 2 Size: 1999 GB</b>		<input type="button" value="Verify"/>
Status: OK		
Disk: 6 Status: OK	<input type="button" value="Remove"/>	
Disk: 7 Status: OK	<input type="button" value="Remove"/>	
Disk: 8 Status: OK	<input type="button" value="Remove"/>	
Disk: 9 Status: OK	<input type="button" value="Remove"/>	
Disk: 10 Status: OK	<input type="button" value="Remove"/>	
Disk: 11 Status: OK	<input type="button" value="Remove"/>	
<b>FREE DRIVE POOL - SCSI ID: 99 Size: 0 GB</b>		
Status: EMPTY		
<b>ALARM MESSAGES:</b>		

- If the process fails, an error message similar to the following appears. You must replace the applicable disk. For more information, see *Purchasing a Spare Disk Drive*.

**Error Adding Hot Spare Disk**

Unable to add the requested disk as a Hot Spare.

## Purchasing a Spare Disk Drive

- 1 Note the serial number of your REO Appliance, which is located on the exterior of the appliance.
- 2 Contact your local reseller or contact Customer Support at Overland Storage.

For contact information, see *Customer Support* on page 159.



## Does the Appliance Automatically Start After a Power Outage?

If the facility in which your REO Appliance is installed experiences an interruption in power, the appliance will not automatically run through the power-up sequence when power is restored. You must manually start the appliance.





# C Updating the Appliance

## APPENDIX

Updates for your product might be available via the Overland Storage Web site. The update might be for the software, for the different instances of firmware on the appliance, or for both. Overland Storage recommends that you note what version of the product you have installed and check the Web site to see if an update is available.

## Determining the Version of the Product

- 1 Log on to the software console.
- 2 In the left pane, under **System Menu**, click **Maintenance**.

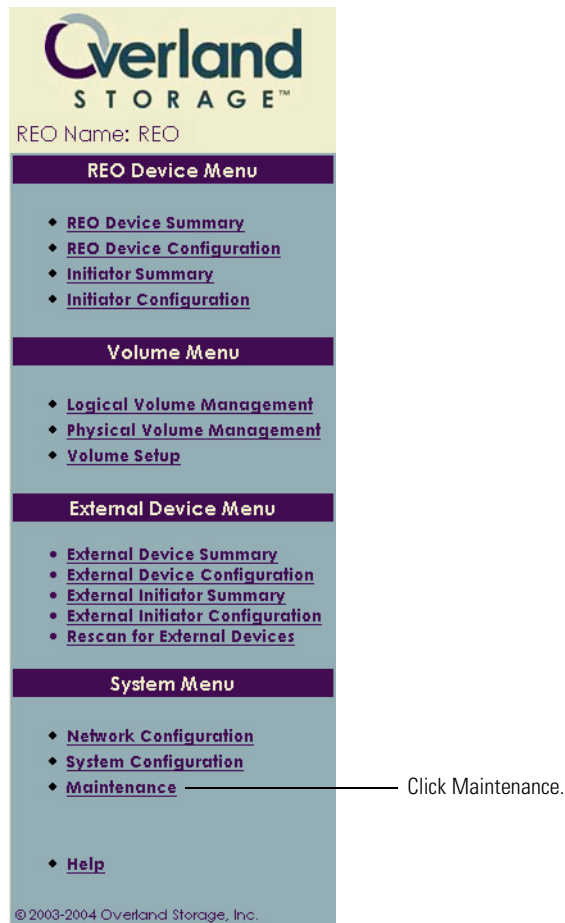

- 3 In the **System Maintenance** page, under **REO Information**, note what is listed for **Product Version**.

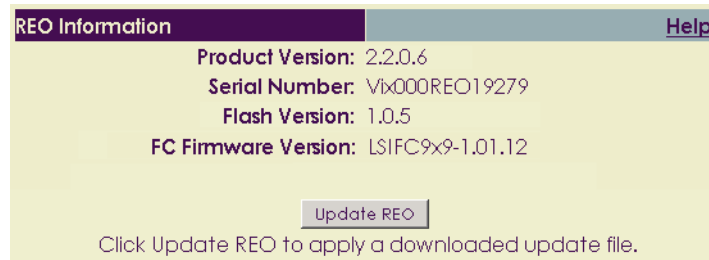

## Checking For and Downloading Updates

- 1 Go to the Overland Storage Web site at: [www.overlandstorage.com](http://www.overlandstorage.com)  
 2 Click **SERVICE & SUPPORT**.



- 3 Log on via the **MEMBER LOGIN** section.

For more information, see *Registering Your Product* on page 159.

The screenshot shows a 'MEMBER LOGIN' form with the following fields and options:

- E-mail:
- Password:
- 
- Remember Me
- > [Forgot your password?](#)
- > [New member? Click Here!](#)
- > [Neue Mitglieder? Hier Klicken!](#)
- > [Nouveaux Membres? Cliquez Ici!](#)

- 4 Click **KNOWLEDGE CENTER**.



- 5 In the **Browse Documents by Category** section, click **Technical**.

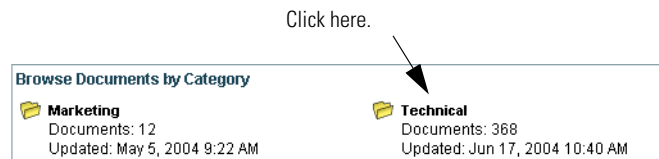

## 6 In the **Sub-Categories** section, click **REO Software and Release Notes**.

**Sub-Categories**

<p> <b>Application Notes</b> Documents: 35 Updated: Mar 16, 2004 4:00 PM</p> <p> <b>EOL Notices</b> Documents: 14 Updated: Apr 28, 2004 9:18 AM</p> <p> <b>Firmware</b> Documents: 27 Updated: Apr 19, 2004 11:14 AM</p> <p> <b>Product Information Bulletins</b> Documents: 10 Updated: Mar 26, 2004 9:55 AM</p> <p> <b>Utilities</b> Documents: 4 Updated: May 11, 2004 9:26 AM</p>	<p> <b>Drivers</b> Documents: 2 Updated: Apr 14, 2004 3:23 PM</p> <p> <b>FAQS</b> Documents: 235 Updated: Apr 15, 2004 8:41 AM</p> <p> <b>Manuals and Guides</b> Documents: 32 Updated: Apr 15, 2004 12:51 PM</p> <p> <b>Product Specifications</b> Documents: 9 Updated: Mar 18, 2004 4:53 PM</p> <p> <b>REO Software and Release Notes</b> ← Click here. Documents: 4 Updated: May 11, 2004 9:26 AM</p>
--	--

## 7 In the list of results that appears, click the link to the applicable release to download the files.

[Knowledge Center](#) » [Technical](#) » REO Software and Release Notes



**Category: REO Software and Release Notes**  
Sub-Categories: 0, Documents: 3, Updated: Aug 16, 2004 1:36 PM

This section is for the REO products. It contains software updates and release notes.

Search Category  
  [Advanced >](#)

**Documents in this Category**

Sort by

<p> <a href="#">REO update for Version 2.3 (REO 1000, REO 4000, REO 9000)</a> [3812] Last Modified: Oct 19, 2004 9:48 AM The attached files support updates for the REO 1000, REO 4000, and REO 9000 appliances to version 2.3. Updated versions of the Setup Guides are also available.</p>	Rating: Not Rated
<p> <a href="#">REO 1000 and REO 4000 updates for Version 2.1.2.37</a> [3703] Last Modified: Aug 26, 2004 8:26 AM The attached files support updates for the REO 1000 and REO 4000 appliances to version 2.1.2.37. Updated versions of the Setup Guides are also available.</p>	Rating: Not Rated

Click the applicable link.

Because of the size of the upgrade file, you must download it from the FTP server. You can use either a file transfer protocol (FTP) or hypertext transfer protocol (HTTP) to download the files.

Knowledge Center » Technical » REO Software and Release Notes » Document #3703

**[3703] REO update for Version 2.3 (REO 1000, REO 4000, REO 9000)** [« Back to Category](#)

[Email to a Friend](#)
[Rate Document](#)
[Printer Friendly](#)
[Watch](#)

The files posted on the FTP server support updates for the REO 1000, REO 4000, and REO 9000 appliances to version 2.3.

*If you are upgrading from 2.0, 2.1.1, or 2.1.2.37 to any subsequent version of the software, you must install the interim update, version 2.1.3, first, before you can install this version.*

Because of the size of the upgrade file for version 2.3, you must download it from the FTP server. You can use either a file transfer protocol (FTP) or hypertext transfer protocol (HTTP) to download the files. Click one of the following links:

<ftp://ftp.overlandstorage.com/Software/REO/2.3.0.18/>
<http://ftp.overlandstorage.com/Software/REO/2.3.0.18/>

**Attachments**

[Release Notes for REO v2.3.pdf \(328.5 K\)](#)

**Related Documents**

Click the applicable link to access the update.

**FTP directory /Software/REO/2.3/ at ftp.overlandstorage.com**

---

Welcome to OverLand Storage FTP download site.

---

[Up to higher level directory](#)

11/30/2004 10:08AM	420,289	<a href="#">Release Notes for v2.3.0.pdf</a>
11/30/2004 10:09AM	61,934,419	<a href="#">reo.2.3.0.18.upgrade</a>

Download all files for the applicable release.

**8 Download and save each attachment to your computer.**

Tip: If you want to be notified whenever a change is made to REO Software and Release Notes category, click Watch Category.

[My Watches](#)
[Knowledge Center Help](#)
[Watch Category](#)
[Make a Document Recommendation](#)

---

Knowledge Center » Technical » REO Software and Release Notes

**Category: REO Software and Release Notes**  
 Sub-Categories: 0, Documents: 4, Updated: Jun 18, 2004 9:59 AM

This section is for the REO products. It contains software updates and release notes.

**9 Save the files to a temporary location on the management system.**

## Installing an Update

Installing the upgrade does not affect any data that you currently have stored on the REO Appliance; however, Overland Storage strongly recommends that you back up any data on the appliance before you begin the upgrade process.

- 1 Log on to the software console.
- 2 In the software console, under **System Menu**, click **Maintenance**.

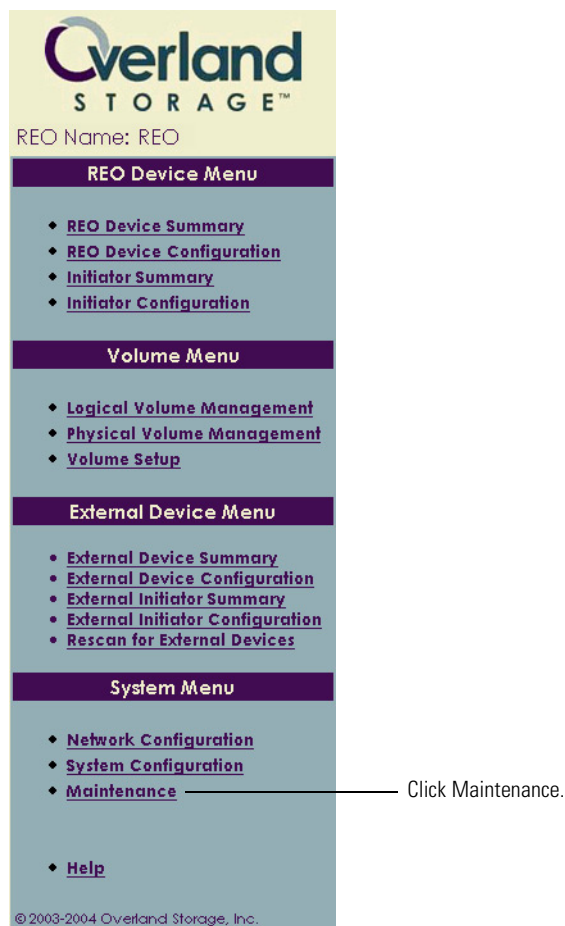

- 3 In the **System Maintenance** page, under **REO Information**, click **Update REO**.

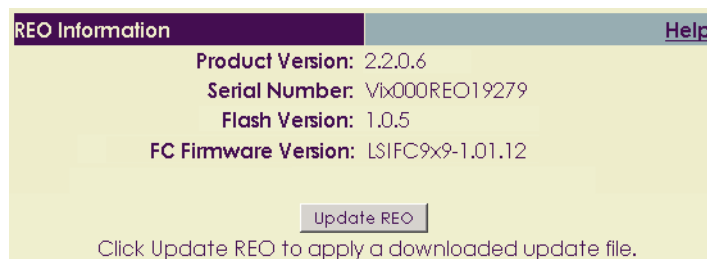

- 4 In the **Update REO using Downloaded File** section, type the path name to point to the file that you downloaded, or click **Browse** to point to it, and then click **Submit**.

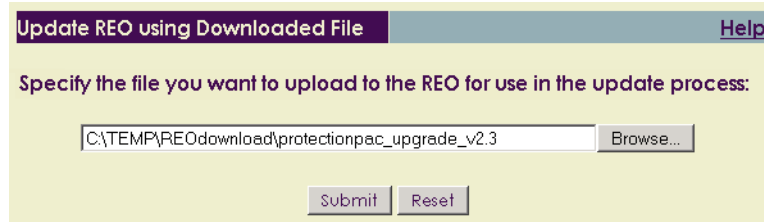

- 5 When the confirmation message appears, click **OK**.

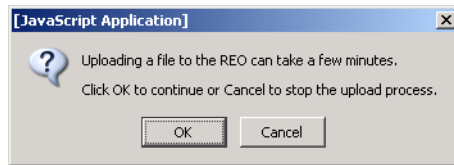

- 6 When the message appears that indicates the file was successfully uploaded, click **Update**.

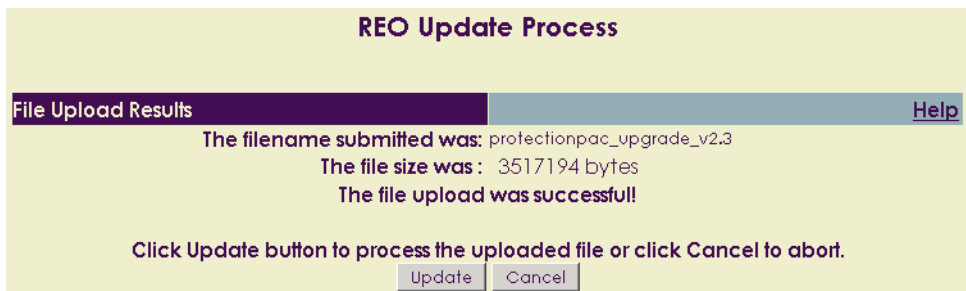

- 7 When the confirmation message appears, click **OK**.

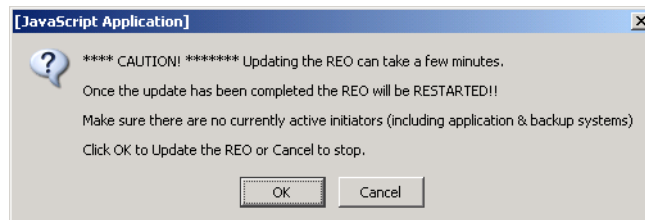

- 8 Wait approximately five minutes before logging back on to the REO Appliance.

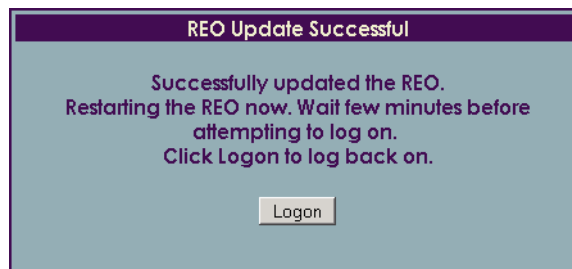

- 9 In the software console, under **System Menu**, click **Maintenance**.



- 10 In the **REO Information** section, note that the **Product Version** now reflects the new version of the software.

If applicable, the Flash Version might also be different.

The screenshot shows the 'REO Information' section with a 'Help' link. The displayed information is:

- Product Version: 2.3
- Serial Number: Vix000REO19279
- Flash Version: 1.0.6
- FC Firmware Version: LSIFC9x9-1.01.12

Below the information is an 'Update REO' button and a note: 'Click Update REO to apply a downloaded update file.'

- 11 If you are using the FC-enabled version of the product, complete the steps in the next section to determine whether an update for the firmware on the FC controller is available.

## Updating the Firmware on the FC Controller

- 1 Review the information listed in the **REO Information** section.

If the firmware on your FC controller needs to be updated, you will see information similar to the following:

The screenshot shows the 'REO Information' section with a 'Help' link. The displayed information is:

- Product Version: 2.3
- Serial Number: Vix000REO19279
- Flash Version: 1.0.6
- FC Firmware Version: LSIFC9x9-1.00.00\*

Below the information is an 'Update REO' button and a note: 'Click Update REO to apply a downloaded update file. \* Indicates that the FC Firmware needs updating.'

- 2 If the firmware needs to be updated, detach the FC cables from the REO Appliance, and then click **Update REO**.
- 3 In the **Fibre Channel Firmware Updates** section of the **REO Update** page, click **Update FC Firmware**.

The screenshot shows the 'REO Update' page with a 'Help' link. The 'Fibre Channel Firmware Updates' section displays:

- Current FC Firmware Version:** LSIFC9x9-1.00.00  
The Fibre Channel Firmware needs updating.
- Available FC Firmware Version:** LSIFC929X-1.01.12 (2004.06.21)  
To update the firmware, click the following button.

**IMPORTANT: The REO will be restarted after the update is complete. Make sure there are no active initiators (including application and backup systems).**

Below the information is an 'Update FC Firmware' button.

- 4 When the confirmation message appears, click **OK** to continue.

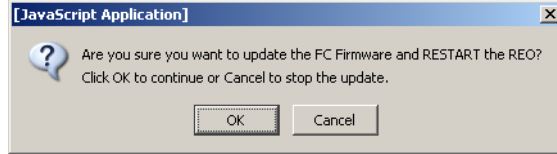

- 5 When the following message appears, attach the FC cables to the appliance.

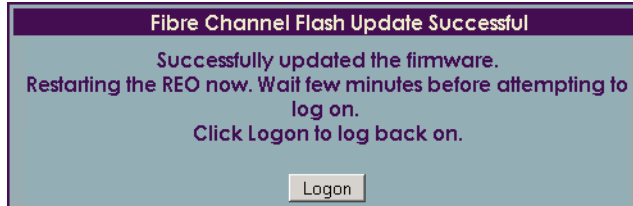

- 6 Wait approximately five minutes before logging back on to the REO Appliance.
- 7 In the software console, under **System Menu**, click **Maintenance**.
- 8 In the **REO Information** section, note that the **FC Firmware Version** now reflects the new version of the firmware.

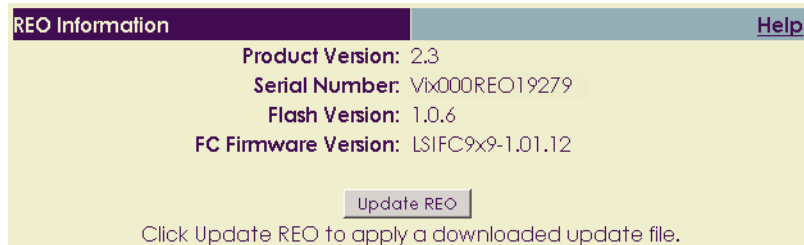



# D Specifications

## APPENDIX

This appendix lists the specifications for the REO Appliance.

### Capacity

Disk Drives	Twelve or Twenty-four SATA × 250 or 400 GB
Raw Capacity	9.6 terabyte (TB)
RAID Levels	JBOD, RAID 0, RAID 5 with hot spare

### Host Interfaces

Hardware	Two GbE Ports (RJ45) One Management Port (RJ45) Two Fibre Channel Ports (LC) Two Ultra320 SCSI Ports (VHDCI) Dual 3+1 RAID controllers
Software	USB Software Key
Storage Protocol	1 gigabit Ethernet/iSCSI, 2 gigabit optical Fibre Channel

### Power Requirements

Voltage	90 to 120 volts alternating current (VAC), 200 to 240 VAC +/- 10 percent
Frequency	47 to 63 hertz (Hz)
Current	6 A at 115 VAC, 3 A at 230 VAC
Power Cord Connector	IEC 60320 C13 Connector
Power Consumption	Steady state 500 watts; peak power 525 watts (fully populated)

### Enclosure

Dimensions	19-by-27-by-8.75 inches (5U rack-mount) (48.26-by-68.58-by-22.22 centimeters)
Weight	130 pounds (59 kilograms)

### Environmental Requirements

#### Operating

Humidity	20% to 80% non-condensing
Temperature	50° to 95°F (10° to 40°C)

Altitude	–984 to 10,000 feet (–300 to 3,048 meters)
Shock	10 G (11 milliseconds half sine)
Vibration	.25 G swept sine (5–250–5 Hz) no errors
<b>Non-operating</b>	
Humidity	10% to 95% non-condensing
Temperature	–40° to 140°F (–40° to 60°C)
Altitude	–984 to 39,370 feet (–300 to 12,000 meters)
Shock	20 G (11 milliseconds half-sine pulse)
Vibration	1.0 G swept sine (5–250–5 Hz)
<b>Agency Approvals</b>	
Safety and Emissions	TUV NRTL U.S./Can, GS (German, TUV), VCCI, BSMI (Taiwan)
<b>Backup Software Interoperation</b>	BakBone NetVault CommVault Galaxy Computer Associates BrightStor ARCserve LEGATO NetWorker Microsoft Windows 2000 Backup utility Syncsort Backup Express VERITAS Backup Exec for Windows NT and Windows 2000 VERITAS NetBackup
<b>Warranty</b>	For warranty information, see the Web site: <a href="http://www.overlandstorage.com">www.overlandstorage.com</a>

## Electromagnetic Emission

### Notice

This equipment has been tested using shielded cables for EMI-compliance. The use of unshielded cables or modifications requires system testing for EMI testing for compliance to the standard.

### Industry Canada

This Class A digital apparatus complies with Canadian ICES-003.

### Industrie Canada

Cet appareil numérique de la classe A est conforme à la norme NMB-003 du Canada.

### FCC Notice

This equipment has been tested and found to comply with the limits for a Class A digital device, pursuant to Part 15 of the FCC rules. These limits are designed to provide reasonable protection against harmful interference when the equipment is operated in a commercial environment. This equipment generates, uses and can radiate radio frequency energy and, if not installed and used in accordance with the instruction manual, may cause harmful interference to radio

communications. Operation of this equipment in a residential area is likely to cause harmful interference in which case the user will be required to correct the interference at his own expense.

## Japan Voluntary Control Council for Interference (VCCI)

この装置は、情報処理装置等電波障害自主規制協議会（VCCI）の基準に基づくクラス A 情報技術装置です。この装置を家庭環境で使用すると電波妨害を引き起こすことがあります。この場合には使用者が適切な対策を講ずるよう要求されることがあります。

### Translation

This is a Class A product based on the standard of the Voluntary Control Council for Interference by Information Technology Equipment (VCCI). If this equipment is used in a domestic environment, radio disturbance may occur, in which case, the user may be required to take corrective actions.

## Taiwan BSMI Class A Warning

### 警告使用者：

這是甲類的資訊產品，在居住的環境中使用時，可能會造成射頻干擾，在這種情況下，使用者會被要求採取某些適當的對策。

# Declaration of Conformity

**DECLARATION OF CONFORMITY**

We, Overland Storage(Europe) Ltd.  
Overland House, Ashville Way  
Wokingham, Berkshire  
RG41 2PL England, United Kingdom

on our own responsibility, declare that the product:

Kind of equipment: REO Series  
Backup / Restore Acceleration Appliance

Type designation: Regulatory series SD3001

is in compliance with the following norms and documents:

European Council Directive 89/336/EEC laws relating to  
electromagnetic compatibility. (EMC Directive)  
EN 55022:1998 Radio Frequency Interference limits and measurement,  
Information Technology Equipment, class A.  
EN61000-3-2:2000, Harmonic Emissions.  
EN61000-3-3:1995, Fluctuations and Flicker.  
EN 55024:1998, Information Technology Equipment - Immunity.  
European Council Low Voltage Directive 73/23/EEC  
EN60950-1:2001 Information Technology Equipment - Safety.

Accredited test laboratory: TUV Product Service  
10040 Mesa Rim Drive  
San Diego, CA, 92121, USA

  
-----  
Stephen F. Rayner  
Director & Company Secretary  
Manufacturer/Authorized  
representative, name and  
signature

11.6.04  
-----  
Overland Storage (Europe) Ltd.  
Overland House, Ashville Way  
Wokingham, Berkshire  
RG41 2PL England, United Kingdom  
place and date of issue



# E | Customer Support

## APPENDIX

If you have a technical question about the REO Appliance, try the following:

- 1 Check the documentation and online Help.
- 2 Check the Web site: [www.overlandstorage.com](http://www.overlandstorage.com)

Updates and Release Notes for the latest versions of the REO Appliance products are available from the Overland Storage Web site. The Release Notes include guidelines for upgrading the software and firmware, describe modifications and enhancements made to the product, and identify issues that you should be aware of when using the product. (For more information, see *Checking For and Downloading Updates* on page 148.)

After you register your product via the Web site, you can view and download the Release Notes, as well as any other applicable documentation, such as the latest version of the Setup Guide.

## Registering Your Product

- 1 Go to the Overland Storage Web site at: [www.overlandstorage.com](http://www.overlandstorage.com)
- 2 Click **SERVICE & SUPPORT**.



- 3 If you have previously registered other products, log on via the **MEMBER LOGIN** section; otherwise, click **SIGN UP NOW**, and follow the onscreen steps to create a logon account.
- 4 Under **MY PRODUCTS**, click **Add or Register a New Product**.
- 5 Enter the serial number of your REO Appliance (usually located on the back of the unit) and delivery date, and click **SUBMIT**.

You can use the Product Selector to select a product and view information about it.

**Products Found: 15**

**Product Selector**

103601-001 - Reo Series ( s/n:SR20R3303002 )

103504-003 - Neo 2000 Series Library ( s/n:2B24827842 )

103511-002 - Neo 2000 Series Library ( s/n:2B13278457 )

103537-001 - Neo 4000 Series Library ( s/n:2B14407302 )

103537-001 - Neo 4000 Series Library ( s/n:2B0807974 )

103553-001 - Neo 2000 Series Library ( s/n:2B4034 )

103572-002 - PowerLoader ( s/n:2B4034 )

103579-001 - Neo 4000 Series Library ( s/n:2B14407302 )

103584-001 - LoaderXpress Loaders ( s/n:2B14407302 )

103584-001 - LoaderXpress Loaders ( s/n:2B14407302 )

103601-001 - Reo Series ( s/n:SR20R3303002 )

103610-001 - Neo 8000 Series Library ( s/n:2B14407302 )

**Products Found: 15** [Register New Product](#)

**Product Selector**

103601-001 - REO 2000 Appliance (s/n:SR20R3303002)

**Product: REO 2000 Appliance**

Model: **103601-001**

Serial Number: **SR20R3303002**

Warranty: **5x9, XNOW, Expires 03/17/2005**

Site: **Overland Storage - San Diego Corporate**

Delivery Date: **03/18/2004**

**Actions:**

- > [Create a Support Request](#)
- > [Manage Library](#)
- > [Add a Component](#)

**Knowledge Center**

- > [All Related Documents](#)
- > [Firmware](#)
- > [Drivers](#)
- > [FAQs](#)
- > [Utilities](#)

## Locating Additional Information for Your Product

- 1 Go to the Overland Storage Web site at: [www.overlandstorage.com](http://www.overlandstorage.com)
- 2 Click **SERVICE & SUPPORT**.



- 3 Log on via the **MEMBER LOGIN** section.

**MEMBER LOGIN**

E-mail:  
sampleuser

Password:  
\*\*\*\*\*

Remember Me

> [Forgot your password?](#)

> [New member? Click Here!](#)

> [Neue Mitglieder? Hier Klicken!](#)

> [Nouveaux Membres? Cliquez Ici!](#)

- 4 Click **KNOWLEDGE CENTER**.



- 5 In the **Browse Documents by Category** section, click **Technical**.
- 6 Use the **Search Category** feature to search for a specific phrase.  
You can also open one of the subcategory folders and search from within it.



**7** If you still have a question, use the following contact information:

<b>For</b>	<b>Contact</b>
<b>Worldwide Headquarters</b>	Overland Storage, Inc. 4820 Overland Avenue San Diego, CA 92123 Toll Free: 1.800.729.8725 Tel: 1.858.571.5555 Fax: 1.858.571.3664
<b>Sales</b>	Telephone: 1.858.571.5555 Fax: 1.858.571.3664 E-mail: sales@overlandstorage.com
<b>Technical Support</b>	Telephone: <ul style="list-style-type: none"><li>■ Worldwide: 1.858.571.5555</li><li>■ EMEA: +44 (0) 118.9898050</li></ul> Fax: 1.858.571.3664 E-mail: support@overlandstorage.com





# Glossary and Acronym List

---

**Application server.** A networked computer on which production programs are running. The programs on an application server typically handle application interaction between an end-user's browser-based programs and a company's back-end database or business applications. (While the application server runs the programs and processes requests, the actual programs and data are usually stored on a file server.)

**Backup server.** A networked computer that actually stores copies of files from other computers or servers or that runs backup software that automates the backup process of moving copies of files to separate storage medium, such as tape.

**D2D.** Disk-to-disk

**D2D2T.** Disk-to-disk-to-tape

**DHCP.** Dynamic Host Configuration Protocol

**File server.** A networked computer on which programs and data files are stored. (While the application server runs the programs and processes requests, the actual programs and data are usually stored on the file server.)

**GbE.** Gigabit Ethernet

**HBA.** Host bus adapter

**Internet SCSI (iSCSI).** A standard protocol for universal access to shared storage devices over standard, Ethernet-based transmission control protocol/Internet protocol (TCP/IP) networks. The connection-oriented protocol transports SCSI commands, data, and status across an IP network.

The iSCSI protocol enables block-level storage applications over TCP/IP networks. It builds on two widely-used technologies—SCSI commands for storage and IP protocols for networking.

- iSCSI uses the SCSI command set, the core storage commands used throughout all storage configurations.
- iSCSI uses IP and Ethernet, the basis for most corporate, metropolitan, and wide-area networks.

iSCSI uses standard Ethernet switches and routers to move the data from server to storage. It also allows IP and Ethernet infrastructure to be used for expanding access to storage area network (SAN) storage and extending SAN connectivity across any distance.

**Tip:** For more information about iSCSI, see the Internet Engineering Task Force (IETF) standards for IP storage at [www.ietf.org](http://www.ietf.org) (Internet Society, 2002. iSCSI (Draft), [www.ietf.org/internet-drafts/draft-ietf-ips-iscsi-13.txt](http://www.ietf.org/internet-drafts/draft-ietf-ips-iscsi-13.txt)).

**Initiator.** The client is an initiator that plays the active role in issuing commands. In iSCSI terms, an initiator is a logical system component (usually present in the form of a device driver) that sends SCSI I/O commands to a target over an I/O bus or network. In this application, the initiator accompanies the initiator software or IP storage HBA on your application or backup server.

**iSCSI target.** The server is a target that plays the passive role in fulfilling client requests. An iSCSI target is a logical system component within an iSCSI appliance that receives SCSI I/O commands from an initiator and executes them. A target includes one or more logical units (LUs); each LU is a SCSI device, such as a disk or tape drive. In this application, the target is the array of disks on the REO Appliance.

**FC.** Fibre Channel

**FC-AL.** Fibre Channel Arbitrated Loop

**FC-SW.** Fibre Channel Switched

**JBOD.** Just a bunch of disks

**LAN.** Local-area network

**LTO-2.** Linear tape-open

**LU.** Logical unit

**LUN.** Logical unit number

**LVM.** Logical volume management

**Mail server.** A networked computer that stores and processes incoming and outgoing e-mail.

**Media server.** A VERITAS Backup Exec server that runs the Backup Exec engine. (Outside the VERITAS backup environment, a media server usually refers to a server that handles the transmission of audio and video information, such as a streaming-media server.)

**Medium Changer.** A secondary device that automates the movement of media to and from a primary device.

**NIC.** Network interface card

**Print server.** A networked computer that stores and processes print requests to a printer from an end-user's computer and returns status information to the end-user.

**RAID.** Redundant array of independent disks

**REO Device ID.** The SCSI target presented to the initiators.

**SAN.** Storage-area network

**SCSI.** Small Computer System Interface

**Target.** The target is a resource that receives and executes client requests.

**TCP/IP.** Transmission Control Protocol/Internet Protocol

**TOE.** TCP offload engine

**U (as in 2U).** Unit; measures the height of a rack-mounted appliance. 1U is equal to 1.75 inches (4.445 centimeters).

**UPS.** Uninterruptible power supply

**Volume.** In this context, there are two types, physical and logical. The physical volume correlates directly to a physical disk drive in a JBOD or RAID configuration. A logical volume is based on a configuration and specification set by you.

**WWNN.** Worldwide node name

**WWPN.** Worldwide port name





# Index

## A

- accessing
  - appliance, prohibited 120
  - software console 99, 122
- adding
  - additional disks 112
  - appliances 107, 108
  - logical volumes 71
- alarm 127
- alerts
  - audio 127
  - e-mail, configuring 58
- appliance does not start 121
- arbitrated loop topology 12
- associating targets and initiators 87

## B

- backing up
  - configuration information 41
  - REO SoftKey 32, 97
- beeping 127
- BOOTPROTO field 34
- BROADCAST field 34

## C

- communication, driver or HBA 61
- configuration file
  - BOOTPROTO field 34
  - BROADCAST field 34
  - IPADDR field 34
  - modifying 33
  - NETMASK field 34
  - NETWORK field 34
- configuring
  - disk devices 73, 81
  - e-mail alerts in the console 58
  - FC 56
  - gateway 52
  - GbE data ports (Data Ports 1 and 2) 55
  - logical volumes 71
  - logon information 58
  - Management Port 52
  - management system 39
  - RAID 65
  - security in the console 58
  - shared devices 116
  - system information 57

- systems used in the backup process 61
- tape devices 73, 81
- targets and initiators 91
- time and date 60
- tracking information 41
- with the REO SoftKey 31

### connecting

- Data Port 1 27
- Data Port 2 27
- External (SCSI) Devices 28
- Fibre Channel Ports 27
- Management Port 26
- power cords 28
- REO SoftKey 36

### console

- accessing 99
- changes not reflected 124
- configuring targets and initiators in 91
- unable to log on 122

### creating

- disk devices 73, 81
- logical volumes 71
- tape devices 73, 81

### critical errors, notifying Overland 58

### customer support 159

## D

- D2D2T backup capabilities 13
- Data Port 1 (GbE)
  - configuring 55
  - connecting 27
- Data Port 2 (GbE)
  - configuring 55
  - connecting 27
- date, configuring in the console 60
- disk devices 73
- disks
  - adding additional 112
  - faulty 129
  - mapping to the appliance 39
  - not visible in Windows Explorer 125
  - numbering of 104
- dynamic tape 16, 77

## E

- e-mail alerts, configuring in the console 58
- eui 88

expanding capacity  
  adding appliances 107, 108  
  adding disks to an appliance 112

External (SCSI) Devices  
  changing target name 84  
  connecting 28  
  detecting 81

External Device Summary page 103  
 External Initiator Summary page 103

**F**

Fibre Channel (FC) 11  
  connecting ports 27  
  connecting to switch 27  
  entering network information 56  
  overview 12  
  topologies 12

**G**

gateway address, verifying configuration 52  
 GbE data ports  
  configuring 55  
  connecting to 27

**H**

help 119, 159  
 host bus adapter (HBA) 11, 61  
 hot spares 16, 66  
  creating 68  
  recreating 141

**I**

Initiator Summary page 102  
 initiators 11  
  associating with targets 87  
  configuring 91

installing  
  in a rack 21  
  iSCSI client driver 61  
  requirements  
  for the network 17  
  iSCSI initiators 17

Internet SCSI, *see* iSCSI  
 IPADDR field 34  
 iqn 88  
 iSCSI  
  architecture 11  
  initiators supported 17  
  naming conventions 87  
  protocol 11

**J**

just a bunch of disks (JBOD)  
  changing to 63  
  forcing an Add 129

**K**

key, *see* REO SoftKey

**L**

LEDs 104

linear tape-open (LTO-2) devices  
  creating 73, 81  
  emulating 16

local-area network (LAN) 11, 13, 26  
 log file 120  
 logical unit numbers (LUNs) 16  
 logical volume management (LVM) 16, 71  
 logon information  
  configuring 58  
  forgotten 128

**M**

Management Port  
  connecting to 26  
  verifying configuration 52

management system, configuring 39

mapping  
  network drive to the appliance on each back-up system 61  
  network drive to the appliance on the management system 39  
  systems restart 127

**N**

N\_Port 12  
 naming conventions for iSCSI 87  
 NETMASK field 34  
 network  
  connecting to 27  
  connecting to the LAN 26  
  FC, entering information 56  
  installation requirements 17  
  safety guidelines 20

NETWORK field 34  
 network interface card (NIC) 61  
 NL\_Port 12  
 numbering of disk drives 104

**P**

password, forgotten 128  
 point-to-point topology 12

ports  
  Data Port 1 27  
  Data Port 2 27  
  Management 26  
  N\_Port 12  
  NL\_Port 12

power  
  attaching cords 28  
  turning off 105

**R**

rack, installing in a 21  
 recreating a hot spare 141

redundant array of independent disks (RAID)  
  changing the configuration 63  
  configuring 65  
  options 15  
  recreating a hot spare 141

removing the REO SoftKey 35  
 REO Device Summary 101  
 REO Devices, creating 73, 81



- REO SoftKey
  - backing up (post-configuration) 97
  - backing up (pre-configuration) 32
  - connecting 36
  - deleted files from 129
  - editing configuration file on 33
  - lost or damaged 129
  - overview 31
  - removing from a Windows system 35
  - Reset option 119
- requirements 16
- S**
- safety guidelines, network location 20
- scalability
  - adding appliances 107, 108
  - adding disks 112
- SCSI devices, *see* External (SCSI) Devices
- SCSI time-out value 18
- security, configuring in the console 58
- ShareDevice
  - accessing a device 117
  - configuring 116
- sharing access between systems 115
- SoftKey, *see* REO SoftKey
- software console
  - accessing 99
  - configuring targets and initiators in 91
- specifications
  - agency approvals 156
  - backup software interoperation 156
  - capacity 155
  - electromagnetic emission 156
  - enclosure 155
  - environmental requirements 155
  - host interfaces 155
  - power 155
  - warranty 156
- storage adapters 11, 61
- storage-area network (SAN) 11, 13, 27
- summary pages
  - External Device Summary 103
  - External Initiator Summary 103
  - Initiator Summary 102
  - overview 100
  - REO Device Summary 101
- switched fabric topology 12
- system, identifying in the console 57
- systems used in the backup process, configuring 61
- T**
- tape devices
  - creating 73, 74, 81
  - emulating 16
- targets 11
  - associating with initiators 87
  - configuring 91
- TCP Offload Engine (TOE) 61
- time zone, configuring in the console 60
- tracking configuration information 41
- transmission control protocol/Internet protocol
  - (TCP/IP) 11
- troubleshooting 119
  - alarm 127
  - appliance does not start 121
  - beeping 127
  - changes not reflected in second browser window 124
  - faulty disk or appliance 129
  - forgot name or password 128
  - log file 120
  - lost or damaged key 129
  - systems restart after mapping 127
  - unable to access appliance 120
  - unable to connect to disk drives 125
  - unable to log on 122
- U**
- uninterruptible power supply (UPS) 28
- UNIX, editing the configuration file 33
- unpacking 19
- USB key, *see* REO SoftKey
- user name, forgotten 128
- V**
- virtual tape 16, 73, 81
- volumes
  - creating logical 71
  - RAID options 15
- W**
- Windows environment, setting the SCSI time-out value 18
- Windows Explorer, disks not visible 125
- worldwide node name (WWNN) 12
- worldwide port name (WWPN) 12



## Free Manuals Download Website

<http://myh66.com>

<http://usermanuals.us>

<http://www.somanuals.com>

<http://www.4manuals.cc>

<http://www.manual-lib.com>

<http://www.404manual.com>

<http://www.luxmanual.com>

<http://aubethermostatmanual.com>

Golf course search by state

<http://golfingnear.com>

Email search by domain

<http://emailbydomain.com>

Auto manuals search

<http://auto.somanuals.com>

TV manuals search

<http://tv.somanuals.com>