



Pacific Accessory Corporation

SWI-JACK

Universal Steering Wheel Control Interface

For Alpine, JVC, Clarion, Kenwood,
 Valor, OEM & Blaupunkt OEM
 Steering Remote Ready Radios

Installation Instructions

Before You Start



A. Is this product compatible with the vehicle?

- See application guide (separate sheet) for listing of vehicles and connection information. If not, please visit <http://www.pac-audio.com/swixprogramming/swixprogramming.asp> for the most current list of compatible vehicles.



B. Prepare for the installation.

- If possible, install the SWI-JACK while you are installing the new head unit. Keep in mind you may need to plug in the factory stereo to locate certain wires; therefore do not complete the head unit installation until the SWI-JACK is working properly.
- Plan a general installation location for both the SWI-JACK plug and the control body. Keep in mind that the supplied wire harness is **two feet long**, and the 1/8" plug harness is **three feet long**.
- Use a multimeter or approved measuring device for checking vehicle circuits.

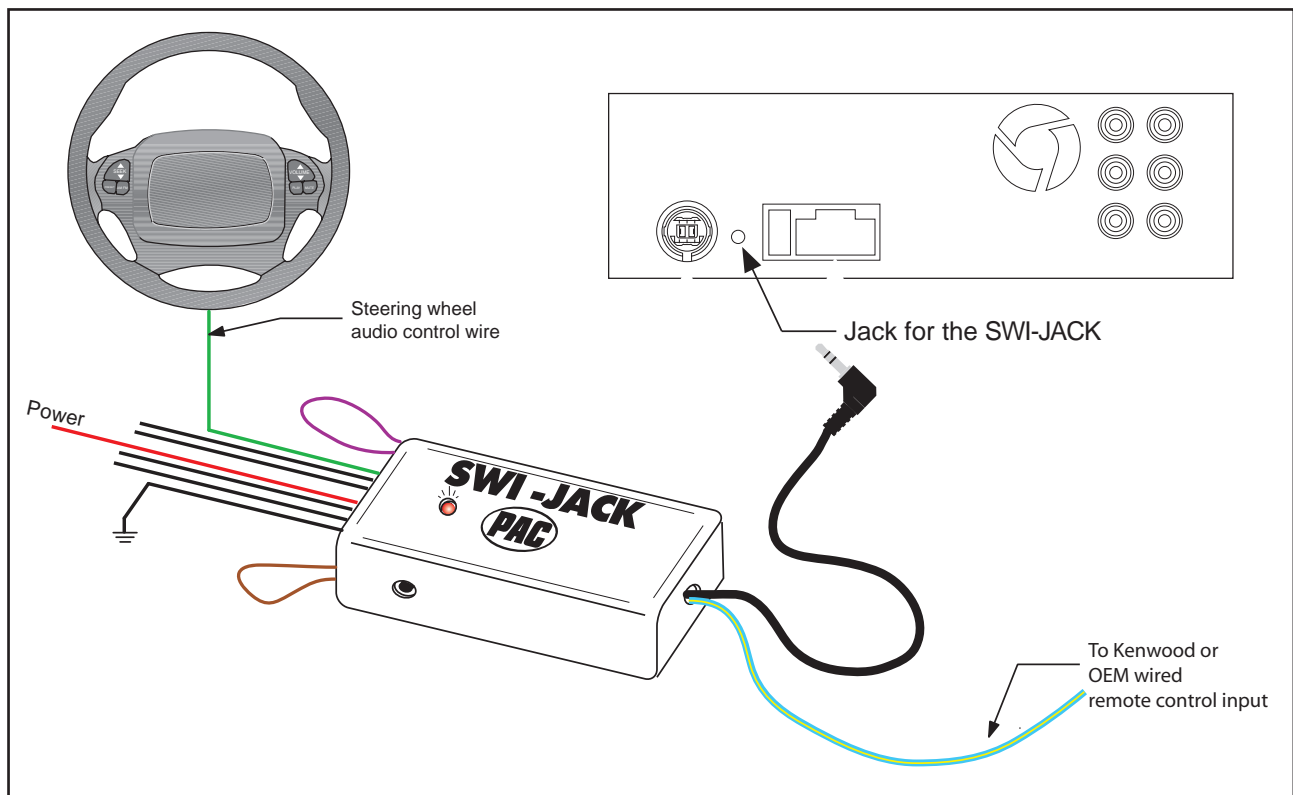

For Alpine, Clarion JVC, or Valor radios, connect the SWI-JACK 1/8" plug into the radio's Steering Wheel input jack on back of radio or wire harness. For Kenwood, or OEM radios, connect the blue/yel wire to the Remote Input wire (blue/yel for Kenwood, gray for OEM) of radio.

Blaupunkt radios with optional wireless remote inputs are supported by the SWI-JACK, however we do not supply any connectors or support for Blaupunkt. It is up to the consumer or installer to supply this connector. Use vehicle Connector Chart and use VW connector as reference. Connect the SWI-JACK's blue/yel wire to pin #11 of VW connector. The connector you obtain may come with two of three pieces, however the connector (usually green) should show pin #11 on it.

Wiring Connections

Note: Only 3 wires from the SWI-JACK will be used during installation. GM vehicles programmed for version #4, will use 4 wires.

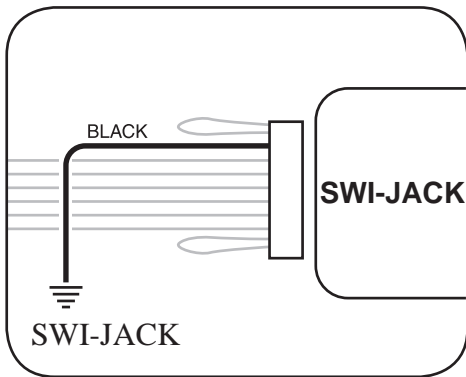

Step 1.
Connect the BLACK wire to ground (-).

Verification: Wire or location registers a constant (-) when probed.

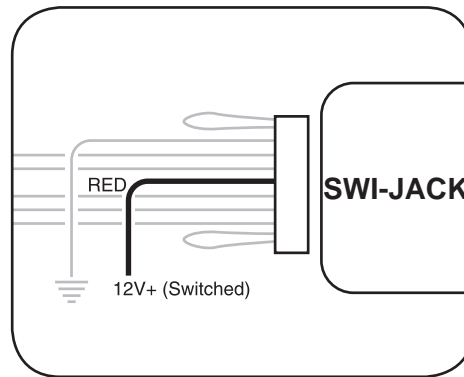

Step 2.
Connect the RED wire to switched +12V.

Verification: Wire registers +12V when the ignition key is turned to the ACC or ON positions.

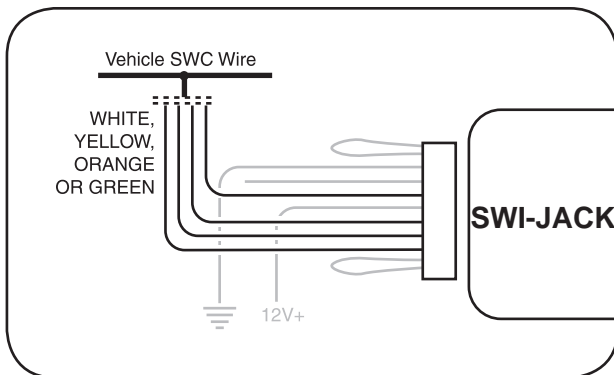

Step 3.

Connect the appropriate interface wire (WHITE, YELLOW, ORANGE or GREEN).

- Refer to the **Identification and Connection Chart**. Locate the vehicle and note the SWC wire color in the "Interface Wire Color" column.
- Note the vehicle wire color and location information in the "Identification" column.

Note: You will only connect ONE of these wires. The other 3 wires will not be used. Cut and insulate the unused wires.

• Connect the wire as indicated in the chart.

• If your vehicle is not listed on the **Identification and Connection Chart**, Visit www.pac-audio.com/swixprogramming/swixprogramming.asp

Step 4

If necessary, perform the following operations as indicated by the notes in **Identification and Connection Chart**.

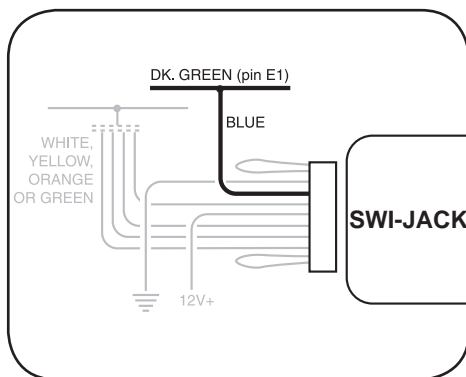

Step 4a.

Connect the BLUE serial data wire. Connect this wire **ONLY** on GM passenger vehicles (no trucks or SUVs) with airbags AND steering wheel heater controls. For all other vehicles, cut and insulate the BLUE wire.



Step 4b.

If instructed by the **Vehicle Application Guide**, cut the BROWN wire loop and insulate both halves.

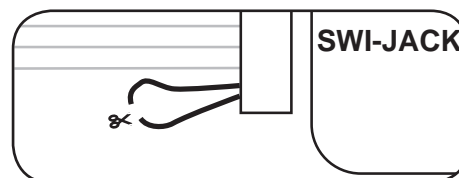

Step 4c.

If instructed by the **Vehicle Application Guide**, cut the VIOLET wire loop and insulate both halves, or place a resistor in-line of wires.

Note: **Step 4a** is for vehicles made by General Motors that are programmed for version #4 only. If no connections is necessary, proceed to Step 4b.

Programming the SWI-JACK to Work With the Vehicle

Step 5.

Refer to **The Vehicle Application Guide**. Note the **INTERFACE Version Number** next to the selected vehicle. Fill in the information below for quick reference. The Radio Select Switch must be set **BEFORE** programming the INTERFACE version number. Set the switch as follows: Alpine = 1, JVC = 2, Kenwood = 3, Clarion = 4 Valor = 5 OEM = 6 and Blaupunkt = 7

Version Number: _____
(Write Version Number here)

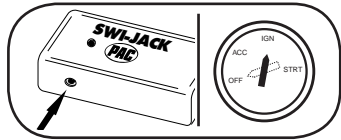

Step 6.

Press and hold programming/mode button on SWI-JACK. Turn the vehicle ignition to the ON position.

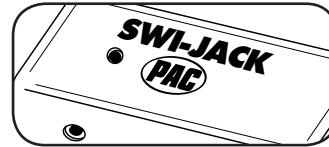

The LED on the SWI-JACK will light.

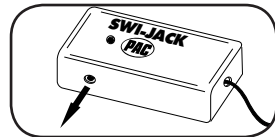

Step 7.

Release the programming/mode button.

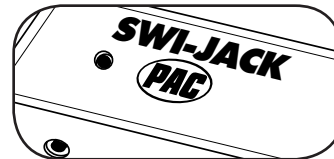

The LED will turn off, indicating memory is cleared.

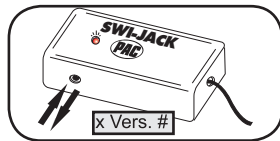

Step 9.

Press and release the programming/mode button the same number of times as the desired version number.

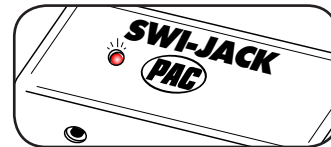

The LED will flash each time the button is pressed and released.

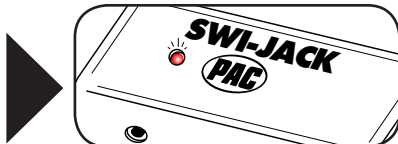

After 3 seconds, the LED will flash the same amount of times of set version number.

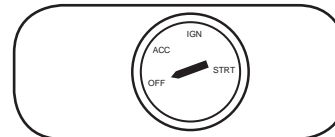

Step 10.

Turn vehicle ignition to OFF position. Vehicle programming sequence is complete.

Programming the SWI-JACK to Control the Head Unit

IMPORTANT! Some steps of the programming instructions **must be completed within a certain number of seconds following the previous step.** Review the complete instruction before beginning the programming sequence.

Step 11.

Turn the vehicle ignition to the ON position.

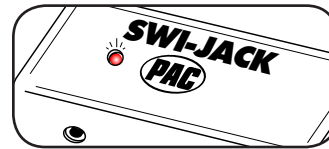
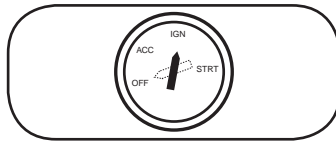

LED will flash to indicate set version number.

If you programmed the interface for version #4, proceed with the following steps.
If you did not program the interface for version #4, skip to Step 18.

Step 12.

Press and hold programming/mode button on SWI-JACK.

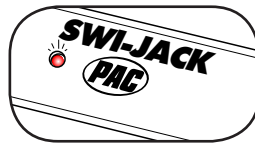
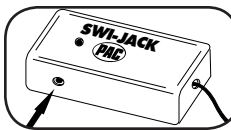

LED will light.

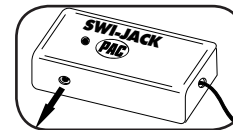

Step 13.

Release programming/mode button.

Step 14.

Press and hold the TEMP UP button on the steering wheel control.

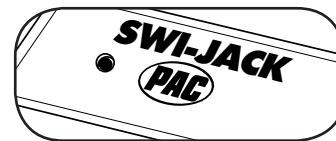
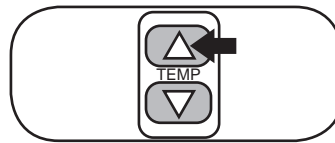

LED will turn off.

Step 15.

Release the TEMP UP button.

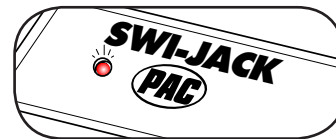
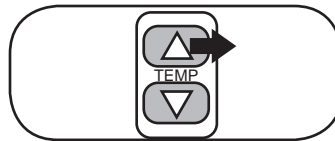

LED will turn on. The function is programmed.

Step 16.

Repeat Steps 14 and 15, using the TEMP DOWN Button.

Step 17a.

If the vehicle is equipped with FAN UP and FAN DOWN buttons:

Repeat Steps 14 and 15 for these buttons as well.



Step 17b.

If the vehicle is NOT equipped with FAN UP and FAN DOWN buttons:

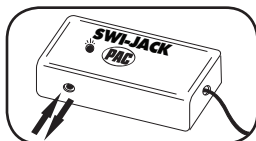

Press and release the programming/mode button on the SWI-JACK.

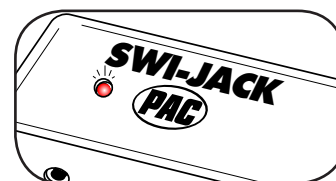

In either case, the LED will flash once and stay on.
Skip to Step 20.
You have 7 seconds to perform the next step.

Step 18.

Press and hold programming/mode button on SWI-JACK.

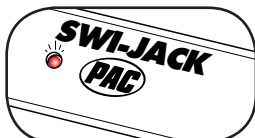
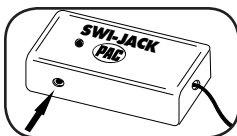

LED will light.

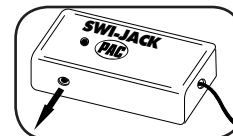

Step 19.

Release programming/mode button.

You only need to press the programming/mode button once to program all the buttons. If you press this button again after the interface is programmed, it will erase all previous learned buttons.

Programming the SWI-JACK to Control the Head Unit (cont.)

The SWI-JACK must be programmed in the specific order shown in the chart below. If a function is not needed, it may be skipped by pressing the Program/Mode button 1 time per function in its place. The LED will flash once (indicating the function has been skipped) and then illuminate, waiting for the next button to be pressed. Adjust the Radio Select switch on the side of the SWI-JACK according to the chart. Alpine = 1, JVC = 2, Kenwood = 3, Clarion = 4, Valor = 5, OEM = 6 and Blaupunkt = 7.

Radio Select Switch Setting	Alpine 1	JVC 2	Kenwood 3	Clarion 4	Valor 5	OEM 6	Blaupunkt 7
1	Vol Up	Vol Up	Vol Up	Vol Up	Vol Up	Vol Up	Vol Up
2	Vol Down	Vol Down	Vol Down	Vol Down	Vol Down	Vol Down	Vol Down
3	Mute	Mute/Power	Mute	Mute	Mute	Mute	Mute
4	Preset Up	Preset Up	Source	Track Up	Source	Source	Source
5	Preset Down	Source	Seek Up	Track Down	OK	Answer Call	Track Up
6	Source	Seek Up	Track Up	Band	Track Up	End Call	Track Down
7	Track Up	Seek Down	Track Down	Source	Track Down	Next	Disc Up
8	Track Down	Select	Disc Up/FM		Up Cursor	Previous	Disc Down
9	Power	Band	Disc Down/AM		Down Cursor	Play	OK
10	Ent/Play		Answer Call			Band	
11	Band/Program						

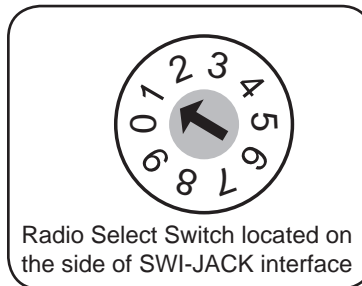

Programming the SWI-JACK to Control the Head Unit (cont.)

Example 1: Alpine Radio - If you have a vehicle with only 3 functions and you want to program Volume Up, Volume Down and Source. Do Step 21 twice, the first time for Volume Up, the second time for Volume Down. Do Step 23 three times to skip Mute, Preset Up and Preset Down. Do Step 21 to program Source. After all 3 buttons have been programmed, you will proceed to Step 24.

Example 2: JVC Radio - If you have a vehicle with only 4 function and you want to program Volume Up, Volume Down, Source and Band. Do Step 21 twice for Volume Up and Volume Down. Do Step 23 two times to skip Mute and Preset Up. Do Step 21 to program Source. Do Step 23 three times to skip Seek Up, Seek Down and Select. Do Step 21 once to program Band. After all 4 buttons have been programmed, you will proceed to Step 24.

Step 20.

- A. If the current function above is what you need to program, proceed to step 21.
- B. If the current function above is not needed, proceed to step 23

Step 21.

Within 7 seconds, press and **hold** the button that is to be learned on the steering wheel.

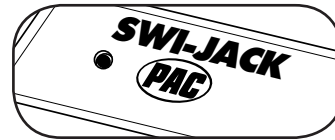
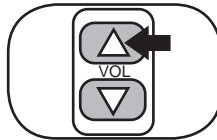

The LED will turn off when the button has been learned.

Step 22.

Release the button.

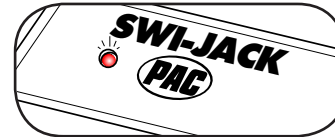
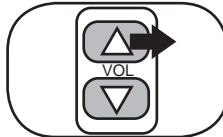

The LED will turn on back on. **Skip to Step 24.**

Step 23.

Within 7 seconds, press and release the programming/mode button on the SWI-JACK.

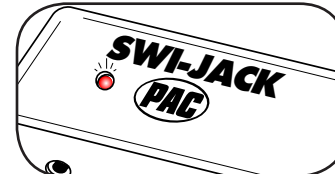
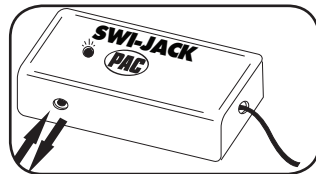

The LED will flash and stay on. This will indicate that the function has been skipped. **Skip to Step 20.**

Step 24.

If you need to program more buttons, repeat step 20 for each additional audio function on the steering wheel.

Program remaining buttons



After all buttons are programmed

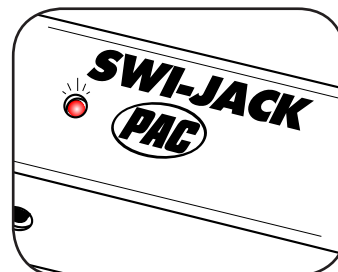

Once programming is completed, wait 7 seconds. The LED will flash three times indicating end of programming. The Interface will then flash the version number it was programmed for.

Testing the SWI-JACK

(For Version #4 only) Test each Heater function of the steering wheel controls. The TEMP and FAN should work properly.

When testing the audio controls, the left LED on the SWI-JACK will flash indicating it is sending a command. If any function does not work, repeat the programming instructions (starting from Step 11) or refer to **Troubleshooting Guide**.

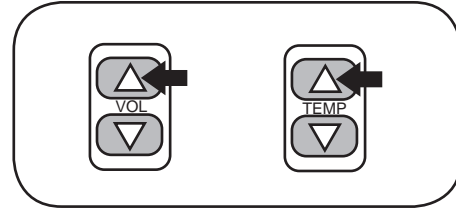

Appendix A: Known Incompatible Vehicles

Vehicle Make	Year / Model	Description
BMW	All	All with 5-volt SWC data wire at the steering column All with factory activated cellular phones
Mercedes	All	All
Chrysler, Dodge, Jeep	2005+ 300c, Charger, Magnum 2005+ Jeep Grand Cherokee 2004+ Durango	The SWI-CAN must also be used.
Porsche	Cayenne	All
Toyota	Sienna	All before 2001
VW	All	With double DIN head units
Volvo	All	All

Appendix B: Resistor Kit

Some vehicles have a separate wire for each of the steering wheel buttons. Use this resistor kit for the steering wheel push buttons that do not already have a resistor network connected to them. Examples are Nissan and Harley Davidson motorcycles.

Connect a resistor to each side of a push button and connect the other ends of the resistor all together. Connect the SWI-JACK to these resistors. On the Harley Davidson, one button can be connected directly to the SWI-JACK.

- 47 = yel, vio, blk
- 100 = brn, blk, brn
- 150 = brn, grn, brn
- 560 = grn, blu, brn
- 1000 = brn, blk, red
- 1500 = brn, grn, red
- 3900 = org, wht, red
- 5100 = grn, brn, red

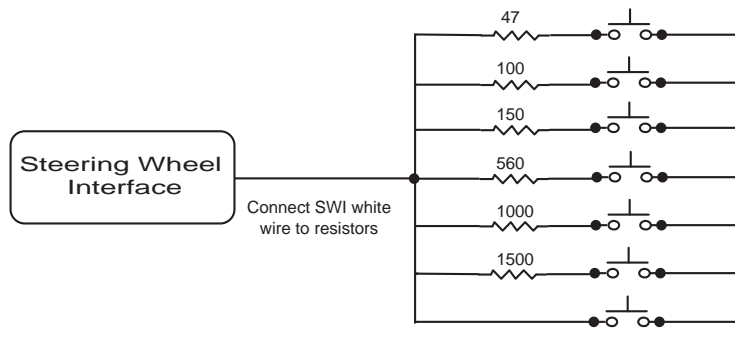

By putting two or more resistor in series, you can come up with additional values. Ex. $150 + 1000 + 1500 = 2650\text{ohms}$.

Troubleshooting Guide

My Vehicle is not listed in the Identification and Connection Chart:

- Please visit <http://www.pac-audio.com/swixprogramming/swixprogramming.asp> for the most up to date listing of compatible vehicles.

No power / won't go into programming mode:

- Check **Red** wire connection and fuse. Make sure INTERFACE is connected to switched +12 volts, not constant +12 volts.
- Make sure vehicle ignition is on.

The INTERFACE controls the stereo immediately without pressing any buttons on the steering wheel

- During programming, press the buttons on the steering wheel firmly UNTIL the left LED turns off. Releasing the button too early will cause the INTERFACE to send out a signal even when no buttons are pressed.

I am using Version # 3, 8, 9 or 11 and the LED goes out after I push the program button and before I push a SWC button:

- Remove any resistors connected to the White INTERFACE wire and ground; then try the program button again.
- If voltage on the INTERFACE's White wire is LESS THAN 4.60v with the key on you need to visit <http://www.pac-audio.com/bulletins/swicalculator.htm>. Here you will find a SWI Calculator. When measuring SWC resistance the INTERFACE's White wire cannot be connected to the vehicle.
- Detach the White Interface wire from the vehicle. Does the LED now stay on when the program button is now pressed?
- If YES: Visit <http://www.pac-audio.com/bulletins/swicalculator.htm> and use the SWI Calculator.
- if NO: The interface needs to be replaced.

The radio changes when the key is off (RAP mode pertaining to GM vehicles) or does not work when the car/truck is running:

- The INTERFACE's Red accessory wire needs to be connected to the same circuit as the radio. If you are using a radio replacement interface that does not supply BATTERY voltage as the ACC. circuit, a relay need to be installed as follows:
- Terminal 86 to supplied ACC wire, Terminal 85 to Gnd Terminal 30 to the INTERFACE Red wire and Terminal 87 to BATTERY.

I cannot program the INTERFACE version number:

- Is the radio selection switch in position "0"? If so refer to page 5 and select a radio position before attempting to program a version number.

When programming the SWC buttons, it takes 5 seconds for the light to go out and it never comes back on:

- Do the connection instructions say to connect another vehicle wire to ACC voltage or chassis ground? If so, test the circuit with a Digital Multi Meter (the factory radio must be plugged in) and verify that the factory radio is providing the same output.

The INTERFACE controls the radio whenever the steering wheel is turned (mostly late 80's early 90's Honda/Acura):

- Program the INTERFACE for version #11.

Working on a new or unlisted vehicle?

We are always looking for new vehicle information. If you've successfully completed the installation on a vehicle with steering wheel controls, and the vehicle is not listed in these instructions or on our Website, contact us at techsupport@pac-audio.com so that we may add the information to the instructions.

Pacific Accessory Corporation

Santa Ana, CA 92705

techsupport@pac-audio.com • www.pac-audio.com

Copyright 2009 Pacific Accessory Corporation. Content subject to change without notice.

Free Manuals Download Website

<http://myh66.com>

<http://usermanuals.us>

<http://www.somanuals.com>

<http://www.4manuals.cc>

<http://www.manual-lib.com>

<http://www.404manual.com>

<http://www.luxmanual.com>

<http://aubethermostatmanual.com>

Golf course search by state

<http://golfingnear.com>

Email search by domain

<http://emailbydomain.com>

Auto manuals search

<http://auto.somanuals.com>

TV manuals search

<http://tv.somanuals.com>