

### Before You Start



#### A. Is this product compatible with the vehicle?

- See Vehicle Application Guide (separate sheet) for listing of vehicles and connection information.
- If your vehicle is not listed, check [www.pac-audio.com/swixprogramming](http://www.pac-audio.com/swixprogramming) for the most current list of compatible vehicles.



#### B. Prepare for the installation.

- Review the application guide for vehicle specific wiring details and note where the steering wheel control wires will be found. Keep in mind that the supplied interface wire harness is **two feet long**
- Use a digital multi meter for checking and verifying vehicle circuits.

### Using the Vehicle Application Guide

The **Vehicle Application Guide** and **Connector images** (included with interface) contain the known locations of steering wheel control wires for vehicles compatible with this interface. If your **Year, Make or Model** is not listed below check [www.pac-audio.com/swixprogramming](http://www.pac-audio.com/swixprogramming) for the most current and up-to-date list of compatible vehicles and radios. You can also reference similar vehicles or years. They may be the same as what you are working with.

Make	Years	Model	Inte
Acura	1992-1998	All models	
Acura	1999-2004	All models	

#### C. Select your make, year and model.

- Choose your **Make, Year, and Model** and highlight the complete column across the page.
- If the exact model and year is not listed, choose a broad **Model** name such as "All Models" or one that describes the radio connector.

#### D. Locating the vehicle steering wheel control wire.

- Determine your **Interface Wire Color** (Green, Yellow, Orange or White). This wire will be connected to vehicle's steering wheel control wire
- The **Interface Connector** (if available) is an image of the vehicle plug. This image is found on the **Vehicle Connector Chart**.
- The **Pin Number and Color** (if available) refers to the vehicle's SWC wire located in the **Interface Connector** (if available).

Interface Wire Color	Interface Connector	Pin Number and Color
White	Honda16	Pin 12
White	Honda20	Pin 3
White	Honda22	Pin 3

Cut Purple?	Cut Brown?	Version	NoteID
No	No	3	11
No	No	3	11
No	No	3	11

#### E. Version number, loops and notes.

- The **Version** number will tell the interface what SWC circuit type is being used. This will be addressed on the next page. The **Note ID** is a vehicle specific programming tip or connection instruction. **Only** read notes in the note chart specified by the **Note ID**. Disregard all others.
- **Cut Purple? Cut Brown?** This refers to the loops on the SWI-ECL2 connector. Cut these loops only if instructed to do so.

#### F. Additional Notes and Interfaces.

- The **Additional Notes** are connections that may have been supplied by the radio prior to removal. These must be made in order to complete the steering wheel control circuit.
- Some vehicles will require an additional CAN bus interface. This will be needed if "Yes" is printed below **CAN Interface** heading.

Additional Notes	CAN Interface?
the 12 Pin connector may have three separate wires for the dash buttons, use resistor kit.	Yes

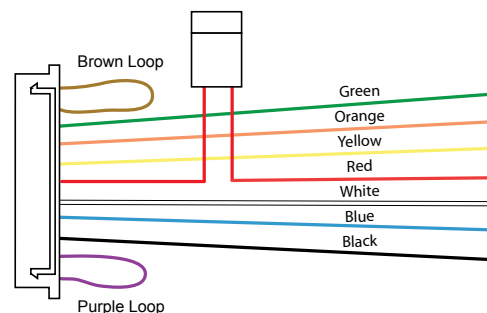

- **Green** - SWC signal input. Used with **Version # 1, 2 or 4** only.
- **Orange** - SWC signal input. Used with **Version # 6 or 7** only.
- **Yellow** - SWC signal input. Used with **Version # 5 or 10** only.
- **Red** - Interface power wire. Must be connected to a 12v ACC. or IGN. source controlled by the key.
- **White** - SWC signal input. Used with **Version # 3, 8, 9, 11 and 12** only.
- **Blue** - GM HVAC data output. Used with **Version # 4** only.
- **Black** - Interface ground wire.

Cut the **Brown** or **Purple** loop if instructed to by the **Vehicle Application Guide**. All connections (including notes and additional notes) must be made before programming the interface.

**\*NOTE** - It is recommended that the **Red** wire is connected to the same ACC. or IGN. wire as the radio.

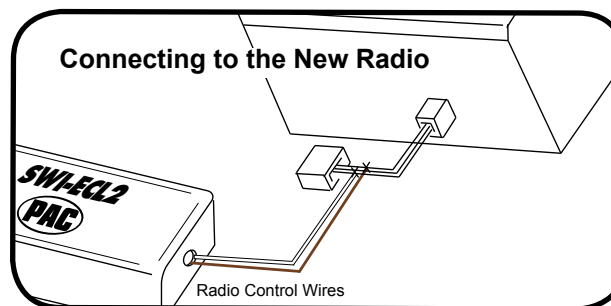

Connect the SWI-ECL2 **Radio Control** wires to the newly installed Eclipse radio. There are 2 known wiring color combinations for the Eclipse radios. Connect according to the chart below.

SWI-ECL2	Eclipse Radio	Eclipse Radio
Brown	→ Brown	Brown
White	→ White	Brown/Black

### Programming the Interface Version Number

#### Step 1.

Refer to the **Vehicle Application Guide** for the version number that corresponds to your vehicle. Write the **Version Number** below for quick reference. Make sure to read all steps before programming as some are time sensitive. If the result indicated to the left of the arrow does not result from the step performed, you must start again. Double checking connections may be necessary before continuing. **At this point all connections should be made and the key should be in the off position. Keeping the door open during programming is recommended to disable the R.A.P. feature (if available)**

**Version Number:** \_\_\_\_\_ (Write Version Number here)

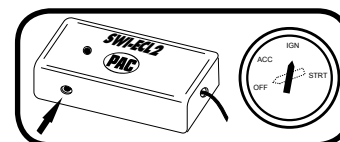

#### Step 2.

Press and hold the **Program Button**. While **holding** the **Program Button**, turn the vehicle key to the **ignition** or **On** position.

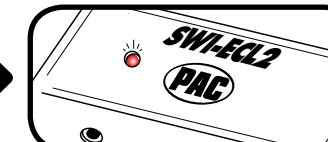

The LED inside of the SWI-ECL2 will turn on and stay on as long as the **Program Button** is held in.

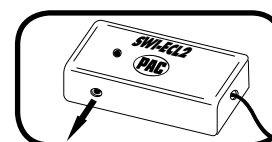

#### Step 3.

Release the **Program Button**.

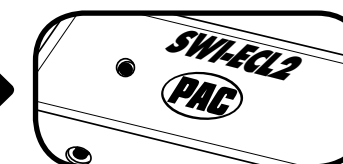

The LED will turn off immediately after the **Program Button** is released indicating previously stored memory has been cleared.

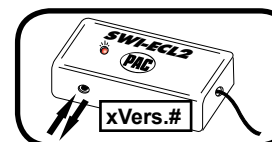

#### Step 4.

Press and release the **Program Button** the same number of times as the version number.

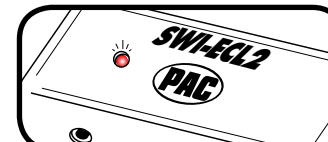

The LED will flash each time the **Program Button** is pressed.

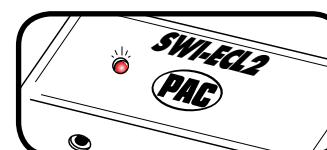

#### Step 5.

**3 seconds** after the last press of the **Program Button**, the LED will flash the same number of times as just pressed. This indicates the programmed version number. Turn vehicle key to the **Off** position. The version programming sequence is now complete.

If the repeated flash count of the LED does not match the version number needed, you must start over at Step 2.

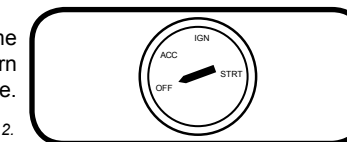

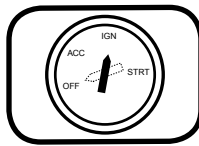

**Step 6.**  
Turn the vehicle key to the ignition or On position.

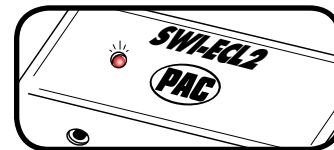

The LED will flash indicating the programmed Version Number.

**STOP**

If you programmed the interface for version #4, proceed with the following steps. If you did not program the interface for version #4, skip to Step 9.

**STOP**

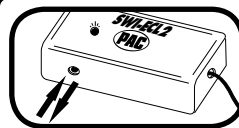

**Step 7.**  
Press the Program Button 1 time and release.



The LED will turn on and stay on.

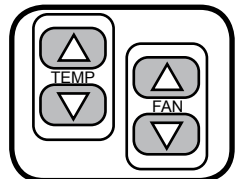

**Step 8.**  
The HVAC control buttons need to be pressed in the order listed below. The LED will turn off indicating that the button pressed has been stored into memory. The button should be held an additional 2 seconds after the LED turns off. Once the button has been released the LED will come back on, waiting for the next button to be pressed.

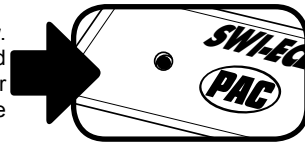

The LED will turn off and stay off until the button pressed has been released.

1)	TEMP UP
2)	TEMP DOWN
3)	FAN UP
4)	FAN DOWN

• If TEMP UP and TEMP DOWN are the only 2 HVAC buttons on the steering wheel, press the Program Button 1 time after the TEMP DOWN button has been released. The LED will flash once and stay on indicating that the HVAC button programming has been completed. You are now entering a timed programming sequence.

• If all 4 buttons are programmed the LED will flash 1 time and stay on after the FAN DOWN button has been released indicating that the HVAC button programming has been completed. You are now entering a timed programming sequence.

**Step 9.**

The SWI-ECL2 must be programmed in the specific order shown in the chart aside. Now that the LED is on you have 7 seconds to press a SWC button. As long as the SWC button is held the LED will stay off and the timer is NOT active. It is recommended to hold the steering wheel button for an additional 2 seconds after the LED turns off. Once the SWC button has been released the LED turns on and the timer is reset, starting over again. If a function is not needed, it may be skipped by pressing and releasing the Program Button in its place. The LED will flash and then stay on indicating the function has successfully been skipped.

1)	Volume Up
2)	Volume Down
3)	Mode
4)	Seek Up
5)	Seek Down

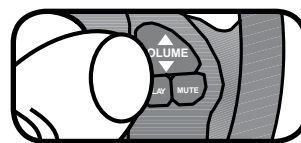

**Step 10.**  
Within 7 seconds, press and hold the button on the steering wheel that is to be learned.



The LED will turn off instantly and stay off as long as the steering wheel button is held. This indicates the button is being stored into memory.

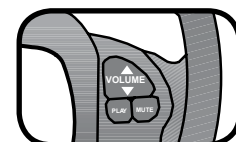

**Step 11.**  
Release the steering wheel button that is currently being programmed.

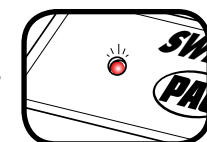
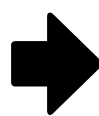

The LED will turn back on. You now have 7 seconds to press a SWC button which will program the next function in the above chart (go to Step 10). To skip the next function in the above chart, go to Step 12. Go to Step 13 when finished programming the SWC buttons

**Step 12. To Skip a Radio Control Function:**

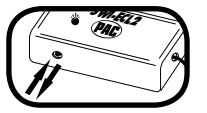

Press the Program Button 1 time and release in place of the radio function that is to be programmed. To program the next function go to Step 10.

The LED will FLASH 1 time to indicate the button was pressed. The LED will stay on waiting for the next button to be pressed

**Step 13. To Exit the Steering Wheel Button Programming Sequence:**

After releasing the last button that is to be programmed, wait 7 seconds. The LED will flash three times to indicate that the steering wheel programming sequence has ended. The interface will then flash the Version Number it was programmed for. You can now test and use the interface.

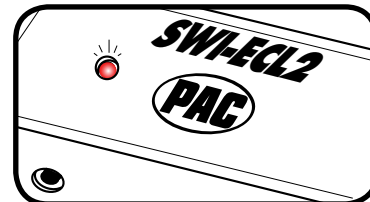

**GM vehicles with HVAC controls:** Test each heater function on the steering wheel. With the HVAC system on, the TEMP and FAN buttons should respond accordingly. The LED will not indicate a button being pressed.

**Testing the Radio Control Buttons:** The LED on the SWI-ECL2 will light up indicating a programmed button has been pressed. The radio should be controlled by the button press as it was programmed to do. If any function does not control the radio as desired, repeat the programming instructions starting at Step 6 or refer to the Troubleshooting Guide.

**Appendix A: Known Incompatible Vehicles**

Make	Years	Model	Description
BMW	All	All with a 5v SWC wire	All with 5-volt SWC data wire at the steering column or a factory installed cellular phone that is in use!
Mercedes	2005-2007	All	Go to <a href="http://www.pac-audio.com">www.pac-audio.com</a> for up-to-date Mercedes CAN bus solutions
Toyota	All-2003	Sienna	Sienna Vans
Volvo	All	All	Go to <a href="http://www.pac-audio.com">www.pac-audio.com</a> for up-to-date Volvo CAN bus solutions

**Appendix B: Resistor Kit**

Some vehicles have a separate wire for each of the steering wheel buttons. Use the supplied resistor kit for the steering wheel push buttons that do not already have a resistor network connected to them. Examples are older Nissan vehicles and Harley Davidson motorcycles.

Value	Color Stripes
47 ohm	yel, vio, blk, gold
100 ohm	brn, blk, brn, gold
150 ohm	brn, grn, brn, gold
560 ohm	grn, blue, brn, gold
1k ohm	brn, blk, red, gold
1.5k ohm	brn, grn, red, gold
3.9k ohm	org, wht, red, gold
5.1k ohm	grn, brn, red, gold

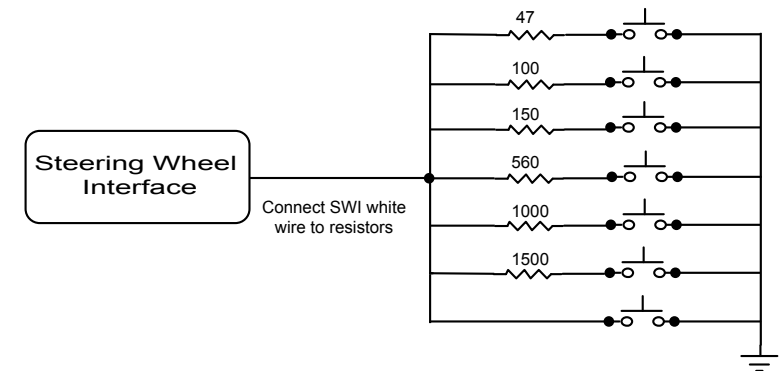

By putting two or more resistor in series, you can come up with additional values. Ex. 150 + 1000 + 1500 = 2650 ohms.

**Troubleshooting Guide**

**No power / won't go into programming mode:**

- Check the Red wire connection and fuse. Make sure Red wire is connected to a key switched 12v, not constant 12v.
- Make sure vehicle ignition is on.

**The interface controls the stereo immediately without pressing any buttons on the steering wheel:**

- During programming, press the buttons on the steering wheel firmly until the left LED turns off and hold for 2 additional seconds.
- Releasing the button too early will cause the interface to send out a radio command even when no buttons are pressed.

**When programming the SWC buttons, it takes 5 seconds for the light to go out and it never comes back on:**

- If a plastic crimp or tap style connection was used, remove and strip wire shielding to verify a wire to wire connection is made.
- Were there any additional connection notes (i.e. connect pin x to ACC voltage or chassis ground)?

**The interface controls the stereo immediately without pressing any buttons on the steering wheel:**

- Is the LED on - if so, during programming press the SWC buttons on the steering wheel firmly and hold for 2 additional seconds after the LED goes out.
- If the LED is not on - Make sure the interface has power and ground. Also make sure the Red wire is connected to the same power source as the radio

**I am using Version # 3, 8, 9 or 11 and the LED goes out immediately after I release the program button:**

- Remove any resistors connected to the White interface wire and ground; then try to program again.
- Detach the White interface wire from the vehicle. Visit [www.pac-audio.com/bulletins/swicalculator.htm](http://www.pac-audio.com/bulletins/swicalculator.htm) and use the SWI Calculator.

**The interface controls the radio whenever the steering wheel is turned (mostly late 80's early 90's Honda/Acura).**

- Program the interface for Version #12.

**DISCLAIMER:** Under no circumstances shall the manufacturer or the distributors of the SWI-ECL2 parts be held liable for consequential damages sustained in connection with the SWI-ECL2. The manufacture and it's distributors will not, nor will they authorize any representative or any other individual to assume obligation or liability in relation to the SWI-ECL2 other than its replacement.

Pacific Accessory Corporation - 1502 S. Santa Fe Street, Santa Ana, CA 92705  
techsupport@pac-audio.com • Voice: 714-835-3022 • Fax: 714-835-3233 • [www.pac-audio.com](http://www.pac-audio.com)

## Free Manuals Download Website

<http://myh66.com>

<http://usermanuals.us>

<http://www.somanuals.com>

<http://www.4manuals.cc>

<http://www.manual-lib.com>

<http://www.404manual.com>

<http://www.luxmanual.com>

<http://aubethermostatmanual.com>

Golf course search by state

<http://golfingnear.com>

Email search by domain

<http://emailbydomain.com>

Auto manuals search

<http://auto.somanuals.com>

TV manuals search

<http://tv.somanuals.com>