

EasyNote NS11HR

SERVICEGUIDE

Revision History

Please refer to the table below for the updates made on the EasyNote NS11HR service guide.

Date	Chapter	Updates

Service guide files and updates are available on the ACER/CSD web. For more information, refer to <http://csd.acer.com.tw>

Copyright

© 2010 Packard Bell is a registered trademark of Packard Bell BV. All rights reserved. All other brands and product names are trademarks or registered trademarks of their respective companies.

Contents

Chapter 1: System specifications	1
Preface	2
Conventions	2
General information	2
Features	3
System block diagram	6
Hardware specifications and configurations	7
CPU	7
Controllers	7
BIOS	7
Memory	8
Hard disk drive	9
Optical drive	9
LCD	10
Keyboard	11
Pointing device	11
Memory card reader	12
Audio	12
Wired LAN	12
Bluetooth	13
Wireless LAN	13
USB	13
Buttons/Indicators/Ports	14
Camera	14
Fans	14
Battery	15
Power supply	15
Power savings	16
Chapter 2: System utilities	17
BIOS setup utility	18
Navigating the BIOS setup utility	19
BIOS setup utility menus	19
BIOS recovery	28
Creating the Crisis Recovery disk	28
Performing a BIOS recovery	28
Running the Flash utility:	29
Clearing a BIOS password	30
Unlocking the hard drive	31
Chapter 3: Replacing notebook components	33
Preventing static electricity discharge	34
Tape	34
Preparing the work space	35

Required tools	36
Preparing the notebook	37
Removing the battery	38
Removing the bay cover	39
Replacing the hard drive	41
Replacing the wireless card	43
Adding or replacing memory modules	45
Replacing the optical drive	46
Replacing the palm rest module	48
Replacing the touchpad board	51
Replacing the keyboard	53
Replacing the speakers	58
Replacing the power button board	61
Replacing the USB board	63
Replacing the Bluetooth module	65
Replacing the system board	67
Replacing the cooling assembly	70
Replacing the processor	73
Replacing the LCD panel assembly	76
Replacing the LCD front panel	79
Replacing the webcam	82
Replacing the LCD panel	84
Replacing the LCD panel hinge brackets	88
Replacing the microphone	90
Replacing the antennas	92
Replacing the LCD assembly lid	94
Chapter 4: Troubleshooting	97
Diagnosing problems	98
System test procedures	99
Testing the optical drive	99
Testing the keyboard or auxiliary input device	99
Testing the memory	100
Testing the power system	100
Testing the touchpad	101
Power-On Self-Test (POST) error message	102
Index of error messages	103
Error codes	103
Error messages	103
No-beep error messages	105
Phoenix BIOS beep codes	106
Symptom-to-FRU error messages	111
LCD	111
Power	111

Memory	112
Sound	112
Power management	112
Devices	113
Keyboard and touchpad	113
Intermittent problems	114
Undetermined problems	115
Chapter 5: Connector locations	117
System board layout	118
Top view	118
Bottom view - Discrete model	119
Bottom view - UMA model	120
Chapter 6: FRU (Field-Replaceable Unit) list	121
Introduction	122
Exploded diagram	122
FRU list	124
Appendix A: Test compatible components	147
Introduction	148
Microsoft® Windows 7® Compatibility Test	148
Appendix B: Online support information	151

Contents

CHAPTER 1

System specifications

- [Preface](#)
- [Features](#)
- [System block diagram](#)
- [Hardware specifications and configurations](#)

Preface

Conventions

The following conventions are used in this manual:



Warning

Indicates a potential for personal injury.



Caution

Indicates a potential loss of data or damage to equipment.



Important

Indicates information that is important to know for the proper completion of a procedure, choice of an option, or completing a task.

General information

Before using this information and the product it supports, read the following general information.

This service guide provides you with all technical information relating to the basic configuration decided for Acer's global product offering. To better fit local market requirements and enhance product competitiveness, your regional office may have decided to extend the functionality of a machine (such as add-on cards, modems, or extra memory capabilities). These localized features are not covered in this generic service guide. In such cases, contact your regional offices or the responsible personnel/channel to provide you with further technical details.

When ordering FRU parts: Check the most up-to-date information available on your regional web or channel. If, for whatever reason, a part number change is made, it may not be noted in this printed service guide.

Acer-authorized Service Providers: Your Acer office may have a different part number code to those given in the FRU list of this printed service guide. You must use the list provided by your regional Acer office to order FRU parts for repair and service of customer machines.

Features

Platform

- Processor
 - Intel® Core i3 Processor: 2310M (2.1 GHz)
 - Intel Core i5 Processors: 2410M (2.3 GHz), 2520M (2.5 GHz), 2540M (2.6 GHz)
 - Intel Core i7 Processors: 2620M (2.7 GHz), 2630QM (2.0 GHz), 2720QM (2.2 GHz), 2820QM (2.3 GHz)
- Core logic: Mobile Intel HM65 Express Chipset
- Wireless
 - Foxconn Wirelss LAN Atheros HB95BG (HM) T77H121.10
 - Foxconn Wireless LAN Atheros HB97 2x2 BGN (HM)
 - Foxconn Wireless LAN Broadcomm 43225 2x2 BGN (HM) T77H103.00
 - Liteon Wireless LAN Atheris HB97 2x2 BGN (HM) WN6603AH
 - Liteon Wireless LAN Realtek 8192SE BGN WN6603LH (2x2 BGN)
 - Lan Intel WLAN TBD Taylor Peak 2x2 AGN

System memory

- DDR3 SO-DIMM
- Data rate supported: 1066/1333 MT/s
- Maximum memory: 8 GB (using two SO-DIMM modules)

Display and graphics

- 14.0" WXGA LED LCD panel
- VGA controller:
 - Discrete model: NVIDIA® N12P-GS or NVIDIA N12P-GV with DDR3-800 1 GB or 2 GB VRAM with DDR3-800 1 GB or 2 GB VRAM
 - UMA model: Integrated in the Mobile Intel HM65 Express Chipset
- Dual independent display support
- 16.7 million colors
- MPEG-2/DVD hardware-assisted capability (acceleration)
- MPEG-2/DVD decoding (for selected models)
- WMV9 (VC-1) support (acceleration)
- WMV9 (VC-1) and H.264 (AVC) decoding (for selected models)
- HDMI™ (High-Definition Multimedia Interface) with HDCP (High-bandwidth Digital Content Protection) support

Storage subsystem

- Industry standard 2.5" SATA hard drive (250–750 GB)
- Optical drive options:
 - Blu-ray Disc™/DVD-Super Multi double-layer drive
 - DVD-Super Multi double-layer drive
- 5-in-1 card reader, supporting Secure Digital™ (SD), MultiMediaCard (MMC), Memory Stick® (MS), Memory Stick PRO™ (MS PRO), xD-Picture Card™ (xD)

Input devices

- 86-, 87-, or 91-key keyboard, 2.5 mm (minimum) key travel
- Twelve function keys, four cursor keys, one Windows® key
- Multi-touch touchpad pointing device

Audio

- Two built-in stereo speakers
- Internal analog microphone
- Realtek Audio Codec ALC271X
- Supports Dolby Advanced Audio technology
- MS-Sound compatible

Communication

- Integrated webcam
- WLAN: Foxconn Wireless LAN Atheros HB95BG (HM) T77H121.10, Foxconn Wireless LAN Atheros HB97 2x2 BGN (HM), Foxconn Wireless LAN Broadcom 43225 2x2 BGN (HM) T77H103.00, Liteon Wireless LAN Atheros HB97 2x2 BGN (HM) WN6603AH, Liteon Wireless LAN Realtek 8192SE BGN WN6603LH (2x2 BGN), Lan Intel WLAN TBD Taylor Peak 2x2 AGN
- WPAN: Foxconn Bluetooth ATH AR3011, BRM 2046 BT 2.1, BRM 2070 BT 2.1, BRM 2046 BT3.0, BRM 2070 BT 3.0, or ATH BU12 BT 3.0
- LAN: Broadcom BCM57785X

I/O ports

- External display (VGA) port
- Microphone in
- Headphone
- HDMI™ port with HDCP support
- USB 2.0 port (two)
- USB 2.0/3.0 port (one)
- Ethernet (RJ45) jack
- DC in jack for AC adapter

Security

- Kensington lock slot
- BIOS-based user, supervisor, and HDD passwords

Physical specifications

- Dimensions: 342 x 245 x 37 mm (13.46 x 9.64 x 1.46 in)
- Weight: < 2.28 kg (5.027 lb) (including battery)

Environmental specifications

- Temperature
 - Operating: 32 °F to 90 °F (0 °C to 35 °C)
 - Non-operating: -4 °F to 140 °F (-20 °C to 60 °C)
- Humidity (non-condensing)
 - Operating: 10% to 90%
 - Non-operating: 5% to 95%

System block diagram

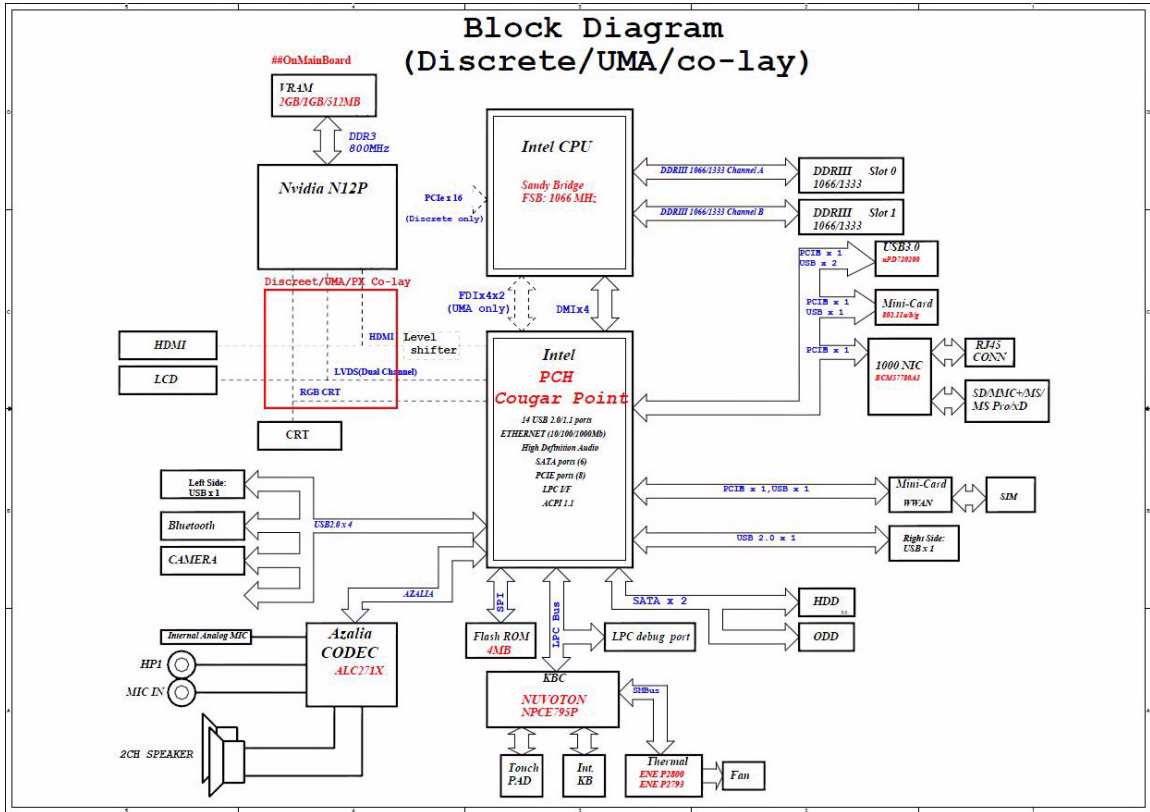

Hardware specifications and configurations

CPU

Item	Specification
CPU type	<ul style="list-style-type: none"> ▪ Intel Core i3 Processor: 2310M (2.1 GHz) ▪ Intel Core i5 Processors: 2410M (2.3 GHz), 2520M (2.5 GHz), 2540M (2.6 GHz) ▪ Intel Core i7 Processors: 2620M (2.7 GHz), 2630QM (2.0 GHz), 2720QM (2.2 GHz), 2820QM (2.3 GHz)
Core logic	Mobile Intel HM65 Express Chipset
Socket type	LGA 1155

Controllers

Item	Controller
Core logic	Mobile Intel HM65 Express Chipset
VGA	<ul style="list-style-type: none"> ▪ Discrete model: NVIDIA® N12P-GS or NVIDIA N12P-GV with DDR3-800 1 GB or 2 GB VRAM ▪ UMA model: Integrated in the Mobile Intel HM65 Express Chipset
LAN	Broadcom BCM57785X
USB 2.0	Mobile Intel HM65 Express Chipset
Bluetooth	Foxconn Bluetooth ATH AR3011, BRM 2046 BT 2.1, BRM 2070 BT 2.1, BRM 2046 BT3.0, BRM 2070 BT 3.0, or ATH BU12 BT 3.0
Wireless LAN	<ul style="list-style-type: none"> ▪ Foxconn Wirelss LAN Atheros HB95BG (HM) T77H121.10 ▪ Foxconn Wireless LAN Atheros HB97 2x2 BGN (HM) ▪ Foxconn Wireless LAN Broadcomm 43225 2x2 BGN (HM) T77H103.00 ▪ Liteon Wireless LAN Atheris HB97 2x2 BGN (HM) WN6603AH ▪ Liteon Wireless LAN Realtek 8192SE BGN WN6603LH (2x2 BGN) ▪ Lan Intel WLAN TBD Taylor Peak 2x2 AGN
Memory card reader	Alcor AU6433
Audio codec	Realtek ALC272

BIOS

Item	Specification
BIOS vendor	Phoenix
BIOS version	1.02

Item	Specification
Supported protocols	<ul style="list-style-type: none"> ▪ Legacy BIOS and EFI architecture support ▪ ACPI 3.0b compliance ▪ PXE specification version 2.1 ▪ SMBIO Reference specification version 2.5 or later ▪ USB specification revision 1.1/2.0/3.0 ▪ ASF specification version 2.0 or later ▪ PCI Express base specification revision 2.1 ▪ PCI BIOS specification revision 2.1 ▪ BIOS Boot specification version 1.01 ▪ Simple boot flag specification version 2.1 ▪ System management bus specification version 2.0 ▪ AHCI support ▪ Microsoft XP/Vista/Windows 7 logo program ▪ Microsoft SLP 1.0 support ▪ Microsoft OA 2.0/2.1 support
BIOS password control	Manually set

Memory

Item	Specification
Memory controller	Built-in
Memory size	0 MB (no on-board memory)
SO-DIMM socket number	2 sockets
Supports maximum memory size	8 GB
Supports SO-DIMM type	DDR3 synchronous DRAM
Supports data rate	1066/1333 MT/s
Supports SO-DIMM package	204-pin SO-DIMM
Memory module combinations	You can install memory modules in any combination as long as they match the above specifications.

Hard disk drive

Item	Specification				
Models	Seagate ST9250315AS Toshiba MK2565GSX HGST HTS545025B9 A300 WD WD2500BPVT- 22ZEST0	Seagate ST9320310AS Toshiba MK3265GSX HGST HTS545032B9 A300/HTS5432 32A7A384 WD WD3200BPVT- 22ZEST0	Seagate ST9500325AS Toshiba MK5065GSX HGST HTS545050B9 A300 WD WD5000BPVT- 22HXZT1	Toshiba MK6465GSX WD WD6400BPVT- 22HXZT1	Seagate ST9750423AS Toshiba MK7559GSX HGST HTS547575A9 E384 WD WD7500BPVT- 22HXZT1
Capacity (MB)	250000	320000	500000	640000	750000
Bytes per sector	512	512	512	512	512
Data heads	4	4	4	4	4
Drive Format					
Disks	2	2	2	2	2
Spindle speed (RPM)	5400	5400	5400	5400	5400
Performance Specifications					
Buffer size (MB)	8	8	8	8	8
Interface	SATA	SATA	SATA	SATA	SATA
Max. media transfer rate (disk-buffer, Mbytes/s)	100 MB/s ³	3.0 GB/s	3.0 GB/s	3.0 GB/s	3.0 GB/s
DC Power Requirements					
Voltage tolerance	5V (DC) ± 5%	5V (DC) ± 5%	5V (DC) ± 5%	5V (DC) ± 5%	5V (DC) ± 5%

Optical drive

Item	Specification	
Models	HLDS Super-Multi Drive GT32N/GT34N Panasonic Super-Multi Drive UJ890A/UJ8A0 Pioneer Super-Multi Drive DVR-TD10RS PLDS Super-Multi Drive DS-8A5SH Sony Super-Multi Drive AD-7585H Toshiba Super-Multi Drive TS-L633F	HLDS BD Combo CT30N Panasonic UJ141AL Pioneer BD Combo BDC-TD03RS PLDS BD Combo DS-4E1S/DS-6E2SH Sony BD Combo 4X BC-5540H Panasonic BD RW UJ240A/UJ240AF
Performance Specification		

CHAPTER 1: System specifications

Item	Specification
Transfer rate (KB/sec)	<p>Sustained:</p> <ul style="list-style-type: none"> ▪ with CD: Max 3.6Mbytes/sec ▪ with DVD: Max 10.08Mbytes/sec <p>Sustained:</p> <ul style="list-style-type: none"> ▪ with CD: Max 3.6Mbytes/sec ▪ with DVD: Max 10.8Mbytes/sec ▪ with BD: Max 11Mbytes/sec
Buffer Memory	<p>2MB</p> <ul style="list-style-type: none"> ▪ for CD/DVD: 2MB ▪ for BD: 4.5MB
Interface	SATA
Applicable disc format	<p>CD: CD-DA, CD-ROM, CD-ROM XA, Photo CD (multi-session), Video CD, Cd-Extra (CD+), CD-text</p> <p>DVD: DVD-VIDEO, DVD-ROM, DVD-R (3.9GB, 4.7GB) DVD-R DL, DVD-RW, DVD-RAM, DVD+R, DVD+R DL, DVD+RW</p> <p>CD:</p> <p>CD-DA (Red Book) - Standard Audio CD & CD-TEXT</p> <p>CD-ROM (Yellow Book Mode1 & 2) - Standard Data</p> <p>CD-ROM XA (Mode2 Form1 & 2) - Photo CD, Multi-Session</p> <p>CD-I (Green Book, Mode2 Form1 & 2, Ready, Bridge)</p> <p>CD-Extra/ CD-Plus (Blue Book) - Audio & Text/Video</p> <p>Video-CD (White Book) - MPEG1 Video</p> <p>CD-R (Orange Book Part)</p> <p>CD-RW & HSRW (Orange Book Part Volume1 & Volume 2</p> <p>Super Audio CD (SACD) Hybrid type</p> <p>US & US+ RW</p> <p>DVD:</p> <p>DVD-ROM (Book 1.02), DVD-Dual</p> <p>DVD-Video (Book 1.1)</p> <p>DVD-R (Book 1.0, 3.9G)</p> <p>DVD-R (Book 2.0, 4.7G) - General & Authoring</p> <p>DVD+R (Version 1.0)</p> <p>DVD+RW</p> <p>DVD-RW (Non CPRM & CPRM)</p> <p>DVD^{DR}R Dual</p> <p style="text-align: right;">Blu-Ray: BD-R, BD-R DL, BD-RE, BD-RE DL</p>
Loading mechanism	<p>Load: Manual</p> <p>Release: (a) Electrical (Release Button), (b) ATAPI command, (c) Emergency</p>
Power Requirement	
Input Voltage	<p>5 V ± 5% (Operating)</p> <p>5 V ± 5% (Operating)</p>

LCD

Item	Specification
Vendor	<ul style="list-style-type: none"> ▪ AUO ▪ CMI ▪ LG ▪ Samsung
Screen diagonal (mm)	14 inches

Item	Specification
Resolution support (pixels)	<ul style="list-style-type: none"> ▪ 2560 x 1600 ▪ 1900x1200 ▪ 1366 x 768 ▪ 1360 x 768 ▪ 1280 x 768 ▪ 1280 x 720 ▪ 1024 x 768 ▪ 800 x 600
Pixel pitch	0.226
Pixel arrangement	R.G.B. Vertical Stripe
Display mode	
Typical white luminance (brightness)	220 nits
Luminance uniformity	1.25 max.
Contrast ratio	400:1, 500:1 or 650:1
Response time (msec)	8
Nominal input voltage VDD	+3.3V
Viewing angle (degree) Horizontal: Right/Left Vertical: Upper/Lower	45/45 20/45
Temperature range(° C) Operating Storage (shipping)	0 to +50 -40 to +60

Keyboard

Item	Specification
Keyboard controller	Nuvoton NPCE795P
Total number of keypads	86/87/91-key
Windows logo key	Yes
Internal & external keyboard work simultaneously	Plug USB keyboard to the USB port directly

Pointing device

Item	Specification
Type	<ul style="list-style-type: none"> ▪ Synaptics TM1465-001 Touchpad ▪ ALPS KGDF0508A Touchpad
Buttons	Left/Right

Memory card reader

Item	Specification
Controller	Alcor AU6433
Cards supported	Support 5-in-1 card reader (MMC, MS, MS-pro, SD, and xD)
Compliance	<ul style="list-style-type: none"> ▪ Complies to SDIO Host Interface Specification Rev 1.0 ▪ Supports MMC, MMCplus, SD Memory, and SDIO cards ▪ SDIO Version 1.10 compliant with High-Speed Mode ▪ SD Host Interface Specification v1.0 ▪ SD Host Interface Specification v2.0 ▪ SD HC (High Capacity SD memory card) ▪ Supports SD memory card, with CPRM security ▪ Complies to MultiMediaCard™ Version 4.0 ▪ Supports Memory Stick™ and MS PRO media cards ▪ Supports xD-Picture™ card and SmartMedia™ cards

Audio

Item	Specification
Audio codec	Realtek ALC271X_VB3
Audio onboard or optional	Built-in
Mono or stereo	Stereo
Resolution	24-bit DAC and ADC
Compatibility	HD Audio
Sampling rate	192 kHz maximum sample rate
Internal microphone	
Internal speaker/quantity	2 speakers

Wired LAN

Item	Specification
LAN chipset	Broadcom BCM57785X
Supports LAN protocol	10/100/1000 Mbps
LAN connector type	RJ45
LAN connector location	Left side
Features	<ul style="list-style-type: none"> ▪ Integrated 10/10/1000 BASE-T transceiver ▪ PCI v2.2 compliant ▪ Wake on LAN support meeting ACPI requirements

Bluetooth

Item	Specification
Chipset	<ul style="list-style-type: none"> ▪ Foxconn Bluetooth ATH AR3011 ▪ Foxconn Bluetooth BRM 2046 BT 2.1 ▪ Foxconn Bluetooth BRM 2070 BT 2.1 ▪ Foxconn Bluetooth BRM 2046 BT3.0 ▪ Foxconn Bluetooth BRM 2070 BT 3.0 ▪ Foxconn Bluetooth ATH BU12 BT 3.0
Data throughput	2.1 Mbit/s
Protocol	Bluetooth 2.1/3.0
Interface	USB (board level)
Connector type	Wireless via Bluetooth protocols

Wireless LAN

Item	Specification
Chipset	<ul style="list-style-type: none"> ▪ Foxconn Wirelss LAN Atheros HB95BG (HM) T77H121.10 ▪ Foxconn Wireless LAN Atheros HB97 2x2 BGN (HM) ▪ Foxconn Wireless LAN Broadcomm 43225 2x2 BGN (HM) T77H103.00 ▪ Liteon Wireless LAN Atheris HB97 2x2 BGN (HM) WN6603AH ▪ Liteon Wireless LAN Realtek 8192SE BGN WN6603LH (2x2 BGN) ▪ Lan Intel WLAN TBD Taylor Peak 2x2 AGN
Data throughput	11~54 Mbps, up to 270 Mbps for Draft-N
Protocol	<ul style="list-style-type: none"> ▪ IEEE 802.11a ▪ IEEE 802.11b ▪ IEEE 802.11g
Interface	PCI bus (mini PCI socket for wireless module)

USB

Item	Specification
Chipset	Mobile Intel HM65 Express Chipset
USB compliancy level	2.0
OHCI	USB 3.0 host controller
Number of USB ports	3
Location	<ul style="list-style-type: none"> ▪ One on the right side ▪ Two on the left side

Buttons/Indicators/Ports

Item	Specification
Buttons	<ul style="list-style-type: none"> ▪ Power button
Indicators	<ul style="list-style-type: none"> ▪ Bluetooth/Wireless network ▪ Hard drive ▪ Battery charge ▪ Power
Ports	<ul style="list-style-type: none"> ▪ USB (three) ▪ External display (VGA) port ▪ Ethernet (RJ45) ▪ Headphone/SPDIF Audio Out ▪ Microphone in ▪ DC in jack for AC adapter ▪ 5-in-1 card reader (SD™, MMC, MS, MS PRO, xD) ▪ HDMI™ port with HDCP support

Camera

Item	Specification
Model	Chicony 1.3M CH9665SN, CH_6A1_SP Liteon 1.3M LT9665AL/LT6AASP, LT6AASP(09P2BF127), LT_6A1_SP Suyin 1.3M SY9665SN, SY_6A1_SP
Interface	USB 2.0
Resolution	1.3 MP (1280 x800)
LED	

Fans

CPU temperature (° C)	Fan speed (rpm)	Acoustic level (dBA)
45-50	0-3000	29
55-66	0-3300	33
68-74	3300-3800	38
78-83	3800-4100	40
86-91	4100-4800	40

Throttling 50%: % is controlled by operating system. Temperature point is 95 °C. OS shut down at 100 °C; H/W shut down at 105 °C

Battery

Item	Specification
Vendor	<ul style="list-style-type: none"> ▪ LGC ▪ Panasonic ▪ Samsung ▪ Sanyo ▪ Sony ▪ Simplo
Type	Li-ion
Pack capacity	4400mAH
Number of battery cell	6
Package configuration	3 cells in series, 2 series in parallel
Normal voltage	11.1V
Charge voltage	12.6V (max)

Power supply

Item	Specification
Vendor	<ul style="list-style-type: none"> ▪ Chicony ▪ Delta ▪ Liteon ▪ Hipro
Input rating	90V AC to 264V AC, 47Hz to 63Hz
Maximum input AC current	1.7A (max)
Output rating	19V DC, 3.42A, 65W

Power savings

ACPI mode	Power Management
Mech. Off (G3)	All devices in the notebook are turned off completely.
Soft Off (G2/S5)	OS initiated shutdown. All devices in the notebook are turned off completely.
Working (G0/S0)	Individual devices such as the CPU and hard disc may be power managed in this state.
Suspend to RAM (S3)	<ul style="list-style-type: none">▪ CPU set power down▪ VGA suspend▪ PCMCIA suspend▪ Audio power down▪ Hard drive power down▪ Optical drive power down▪ Super I/O low power mode
Save to Disk (S4)	Also called Hibernation mode. System saves all system states and data onto the disc prior to powering off the whole system.

CHAPTER 2

System utilities

- [BIOS setup utility](#)
- [BIOS recovery](#)
- [Clearing a BIOS password](#)
- [Unlocking the hard drive](#)

BIOS setup utility

The BIOS setup utility is a hardware configuration program built into the notebook's BIOS (Basic Input/Output System). The notebook was shipped already properly configured and optimized. However, if the user encounters configuration problems, you may need to run Setup.

► To run the BIOS Setup Utility:

- 1 Turn on the notebook.

If the computer is already turned on, save your data and close all open applications, then restart the computer.

- 2 Press **F2** when the **Press <F2> to enter Setup** prompt appears on the bottom of the screen.

Use the left and right arrow keys to move between selections on the menu bar.

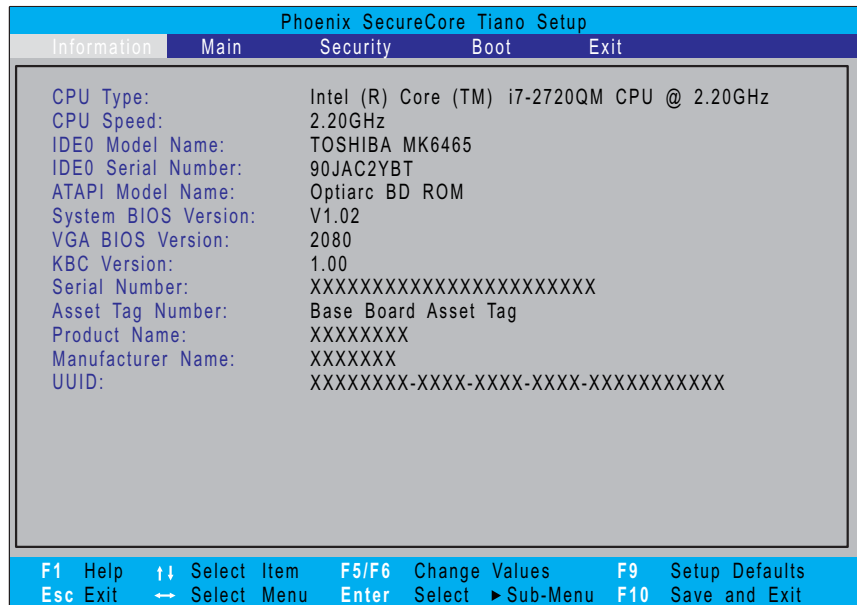

Navigating the BIOS setup utility

Use the keys listed in the legend bar on the bottom of the Setup screen to work your way through the various menu and submenu screens.

► To use the BIOS setup utility:

- To choose a menu, use the left ← and right → arrow keys.
- To choose an item, use the up ↑ and down ↓ arrow keys.
- To change the value of a parameter, press F5 or F6.
- A plus sign (+) indicates the item has sub-items. Press ENTER to expand this item.
- To load default settings, press F9.
- To save changes made and close the utility, press F10.

1 Press Esc while you are in any of the menu screen to display the Exit menu.

 **Important**

- You can change the value of a parameter if it is enclosed in square brackets.
 - Navigation keys for a particular menu are shown on the bottom of the screen. Help for parameters are found in the Item Specific Help part of the screen. Read this information carefully when making changes to parameter values.
 - The screenshots used in this section are for illustration only. The values displayed may not be the same as those in your computer.
-



BIOS setup utility menus

The Setup utility has five menus for configuring the various system functions. These include: Information, Main, Security, Boot, and Exit.

 **Important**

- The screenshots used in this section are for illustration only. The values displayed may not be the same as those in your computer. Actual screen information varies by model, installed features, and location.
 - In the descriptive table following each of the screenshot, settings in **boldface** are the default settings.
-

Information

The Information menu displays a summary of your computer hardware information. These information are necessary for troubleshooting and may be required when asking for technical support.

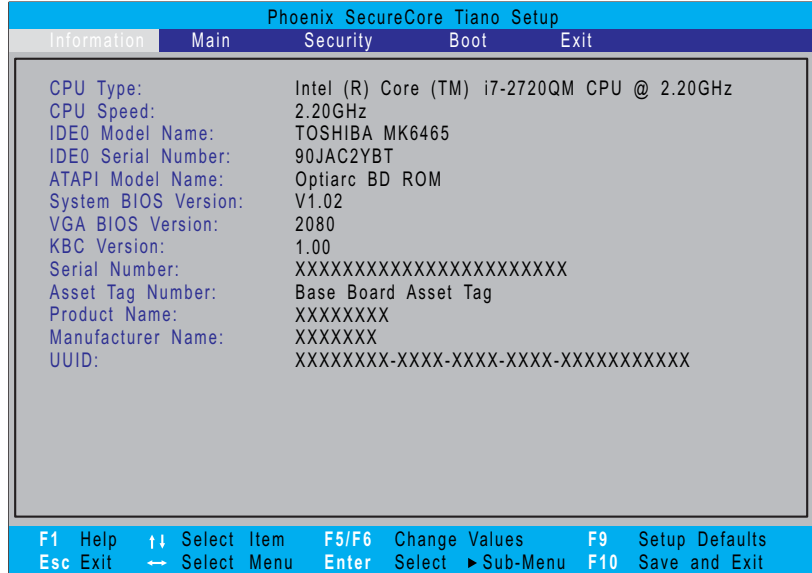

Parameter	Description
CPU Type	Displays the processor model and speed.
CPU Speed	Displays the processor speed.
IDE0 Model Name	Displays the model name of the hard drive installed on the primary IDE master.
IDE0 Serial Number	Displays the serial number of the hard drive installed on the primary IDE master.
ATAPI Model Name	Displays the model name of the installed optical drive.
System BIOS Version	Displays system BIOS version.
VGA BIOS Version	Displays the VGA firmware version.
KBC Version	Displays the keyboard controller version.
Serial Number	Displays the system serial number.
Asset Tag Number	Displays the system asset tag number.
Product Name	Displays the official model name of the computer.
Manufacturer Name	Displays the name of the computer manufacturer.
UUID	Displays the computer's UUID (universally unique identifier). UUID is an identifier standard used in software construction, standardized by the Open Software Foundation (OSF) as part of the Distributed Computing Environment (DCE).

Main

Use the Main menu to set the system time and date, and other basic options.

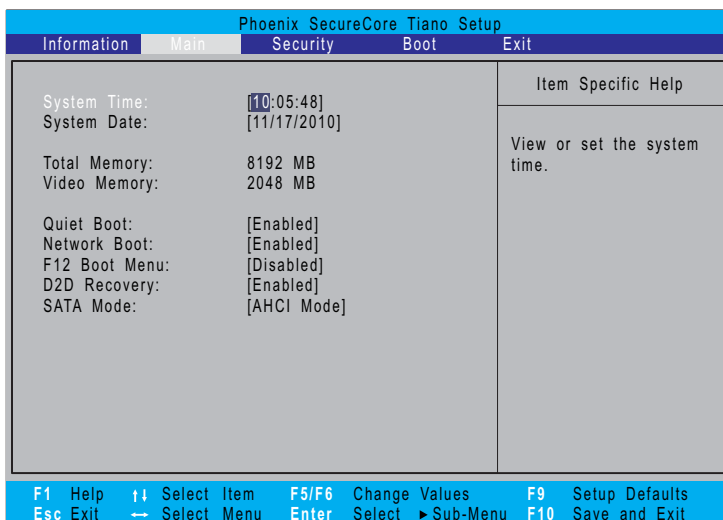

Parameter	Description	Format/Options
System Time	Displays the system time. The time is expressed in a 24-hour format.	HH:MM:SS (hour:minute:second)
System Date	Displays the system date.	MM/DD/YYYY (month/day/year)
Total Memory	Displays the size of system memory detected during boot-up.	
Video Memory	Displays the size of video memory detected during boot-up.	
Quiet Boot	Enables or disables the Quiet Boot function. When enabled, BIOS setup is in graphical mode and displays only the computer brand logo during POST and while booting. When disabled, BIOS setup is in conventional text mode and displays the system Summary Screen.	Disabled Enabled
Network Boot	When enabled, a remote host with appropriate boot image can boot this computer. (only works with an Ethernet device.)	Disabled Enabled
F12 Boot Menu	Enables or disables the Boot menu during POST.	Disabled Enabled

Parameter	Description	Format/Options
D2D Recovery	Enables or disables the D2D Recovery function. This function allows the user to create a hidden partition on the hard drive to store the operation system. User can then use this partition to restore the system to factory defaults by pressing the Alt+F10 keys during system boot-up.	Disabled Enabled
SATA Mode	Select the SATA controller operating mode. When set to AHCI (Advanced Host Controller Interface), the SATA controller enables its AHCI and RAID features when the computer boots up. When set to IDE, the SATA controller disables its AHCI and RAID functions when the computer boots up. Note: If you do not intend to use the AHCI or RAID features set this parameter to IDE to speed up the boot-up time.	AHCI Mode IDE

Security

Use the Security menu option to set system passwords to protect your computer from unauthorized use.

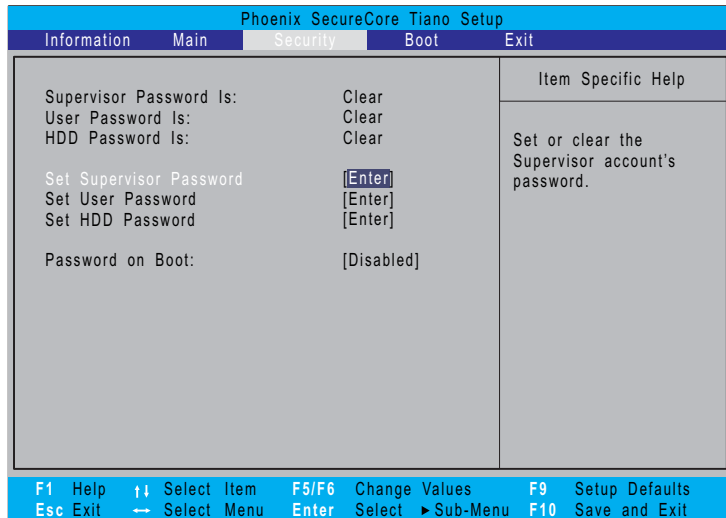

Parameter	Description	Option
Supervisor Password Is	Displays the supervisor password status.	Clear Set
User Password Is	Displays the user password status.	Clear Set
HDD Password Is	Displays the hard drive password status.	Clear Set

Parameter	Description	Option
Set Supervisor Password	Press Enter to set a supervisor password. When set, this password will allow the user to access and change all settings in the Setup Utility.	
Set User Password	Press Enter to set a user password. When set, this password will restrict a user's access to the Setup menus. Only the following menus will be accessible: <ul style="list-style-type: none"> • System Time and System Date • All Exit menu options excluding Load Setup Defaults Note: A supervisor password must first be set before creating a user password. If Password on Boot is enabled, the user must enter the user password each time the notebook is turned on or wakes from Sleep.	
Set HDD Password	Press Enter to set password for accessing the hard disk drive (HDD) password. It will be required during boot-up or when waking from hibernation mode.	
Password on Boot	Referred to as the power-on password. When enabled, the user or supervisor password will be required to boot up the system. Note: A supervisor password must first be set before creating a user password.	Disabled Enabled

Caution

When you are prompted to enter a password, you have three tries before the system halts. Don't forget your password.

Setting a password

Note the following reminders before you define a system password:

- The maximum length of password contains 8 alphanumeric characters.
- System passwords are case-insensitive.
- When typing the password, only shaded blocks representing each typed character are visible.

► To set a supervisor password:

- 1 Press ↑ or ↓ to highlight Set Supervisor Password, then press Enter. The *Set Supervisor Password* box opens.



- 2 Type a password, then press Enter.

- 3 Retype the password to verify the first entry, then press Enter.
You will be prompted to save the new password.
- 4 Press Enter.
- 5 Press F10 to save the password and close the Setup Utility or you can proceed to setting a user password.



▶ To set a user password:

- 1 Press ↑ or ↓ to highlight Set User Password, then press Enter.
The *Set User Password* box opens.
- 2 Type a password, then press Enter.
- 3 Retype the password to verify the first entry, then press Enter.
You will be prompted to save the new password.
- 4 Press Enter.
- 5 Press F10 to save the password and close the Setup Utility.



Changing a password

▶ To change a password:

- 1 Press ↑ or ↓ to highlight the Set Supervisor Password or Set User Password field, then press Enter.
The *Set Supervisor Password* or *Set User Password* box opens.



- 2 Type the current password, then press Enter.
- 3 Type a new password, then press Enter.
- 4 Retype the new password to verify the first entry, then press Enter.
You will be prompted to save the new password.
- 5 Press Enter.
- 6 Press F10 to save the password and close the Setup Utility or you can proceed to setting a user password.



Removing a password

► To remove a password:

- 1 Press \uparrow or \downarrow to highlight the Set Supervisor Password or Set User Password field, then press Enter.

The *Set Supervisor Password* or *Set User Password* box opens.



- 2 Type the current password, then press Enter.
- 3 Press Enter twice without entering anything in the new and confirm password fields.
You will be prompted to confirm the password removal.
- 4 Press Enter.
- 5 Press F10 to save the password and close the Setup Utility or you can proceed to setting a user password.



Resetting a password

If you have forgotten the user password, the computer will continue to function normally but you will have limited access to the Setup utility.

If you have enabled the Password on Boot field and you forget the supervisor password, you will not be able to boot up the computer. The same thing applies if you forget the HDD password.

To clear a lost BIOS password (user or supervisor password) you need to short the clear password hardware gap located on the system board. Go to [page 30](#) for instructions.

To regain access to your computer if you lose the HDD password, you need to generate a master password and unlock your hard drive. Go to [page 31](#) for instructions.

Boot

Use the Boot menu to set the preferred drive sequence in which the Setup utility attempts to boot the operating system.

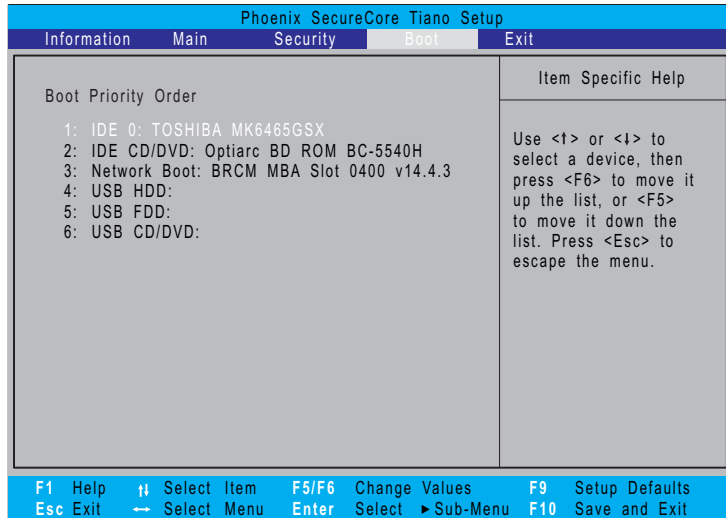

► To set boot drive sequence:

- 1 Press ↑ or ↓ to highlight a bootable device.
- 2 Press F5 or F6 to move the selected device up or down the boot sequence.
- 3 Press F10 to save the changes you made and close the Setup utility.

■

Exit

The Exit menu screen lists options for quitting from the Setup Utility.

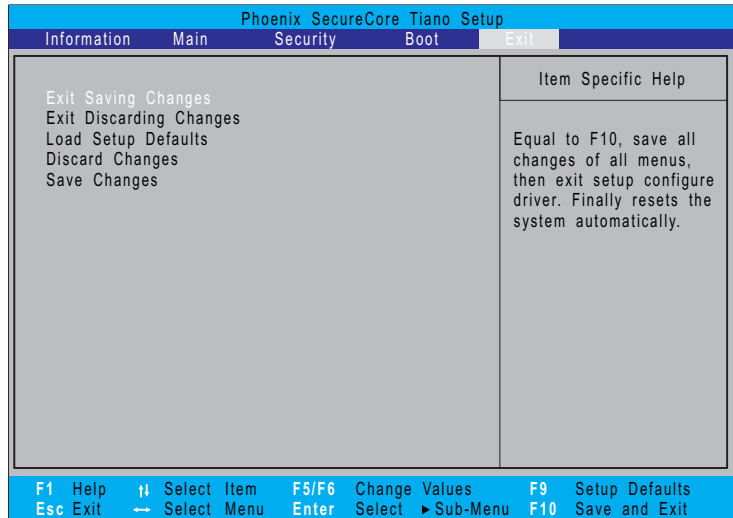

Option	Description
Exit Saving Changes	Saves changes made and closes the Setup utility. Keyboard shortcut: F10
Exit Discarding Changes	Discards changes made and closes the Setup utility.
Load Setup Defaults	Loads the factory-default settings for all Setup parameters. Keyboard shortcut: F9
Discard Changes	Discards all changes made to the Setup utility and loads previous configuration settings.
Save Changes	Saves all changes made to the Setup utility.

BIOS recovery

An interruption during a BIOS flash procedure (e.g. a power outage) can corrupt the BIOS code, which will cause the system to go into an unbootable state. You need to access and execute the boot block program to reboot the computer and recover the regular BIOS code.



Caution

Observe the following when performing a BIOS recovery:

- Make sure the battery pack is installed to the system and that the computer is connected to a UPS unit during the BIOS recovery and BIOS flash procedures.
- The BIOS crisis recovery disk should be prepared in a computer running the Windows XP or Windows Vista OS.

Creating the Crisis Recovery disk

► To create the Crisis Recovery disk:

- 1 Prepare a removable USB storage device with a capacity size greater than 10 MB.

Note that all data on the USB storage device will be cleared during the creation of the crisis disk.

- 2 Set up a computer running the Windows XP or Windows Vista OS and plug in the USB storage device into an available USB port.
- 3 Use the text editor to create a file named startup.nsh with the following contents.

fs0:

PFlash.efi/bb1/silent/sv/sd JV40009j.fd (where JV40009j.fd is the new BIOS image file)

- 4 Copy the startup.nsh file and the following folder and files to the USB storage device.
 - EFI folder
 - BIOS.cap
 - PFlash.efi
 - CrisisRecovery.efi
 - BIOS image file
- 5 Eject and reconnect the USB storage device, and make sure the files are saved to the device.



Performing a BIOS recovery

► To perform a BIOS recovery:

- 1 Shut down the BIOS failed-computer.
- 2 Connect the USB storage device containing the Crisis Recovery disk files to the failed computer.
- 3 Press and hold the Fn+Esc keys (this is the BIOS recovery hotkey), then press the power button.

The BIOS recovery process begins. When the process is complete the computer will automatically reboot.

- 4 Disconnect the USB storage device from the computer.
- 5 Perform a BIOS flash procedure to update the BIOS firmware.



Running the Flash utility:

- ▶ To run the Flash utility:
 - 1 Rename the BIOS file as "XXXXXXX.FD".
 - 2 Copy the "XXXXXXX.FD" file to a bootable USB device containing the Crisis Recovery disk files.
 - 3 Turn off the computer.
 - 4 Insert the USB device containing the renamed BIOS file and the Crisis Recovery disk files to any USB port.
 - 5 Press and hold the Fn+Esc keys (this is the BIOS recovery hotkey), then press the power button.
 - 6 Release the Fn+Esc keys after POST.



Clearing a BIOS password

To clear a lost BIOS password (user or supervisor password) you need to short the clear password hardware gap (G2201) located on the system board.



Gap	Default setting	Function
G2201	Open (normal)	Short to clear the user and supervisor passwords.

► To clear a BIOS password:

- 1 Turn off the notebook and unplug all the peripherals connected to it.
- 2 Complete the steps in [“Removing the battery” on page 38](#).
- 3 Complete the steps in [“Removing the bay cover” on page 39](#).
- 4 Remove the wireless card by performing [steps 3 – 7](#) of the [“Replacing the wireless card” on page 43](#).
- 5 Locate the G2201 gap.
- 6 Use an electrical conductivity tool to short the two contacts on the hardware gap together.
- 7 While resting the tool on the two contacts, plug one end of the AC adapter into the DC power jack and plug one end to an electrical outlet.
- 8 Press the power button to turn on the system.
- 9 After the POST, remove the tool from the hardware gap.
- 10 Reinstall the battery pack, and the bay cover.
- 11 Turn on the notebook and press F2 during bootup to access the Setup utility.
- 12 Press F9 to load the system defaults.
- 13 Press F10 to save the changes you made and close the Setup utility.



Unlocking the hard drive

To regain access to your computer if you lose the HDD password, you need to generate a master password and unlock the hard drive.

► To unlock a hard drive:

- 1 Open the computer in a DOS environment.
- 2 Type the following command:
A\> unlock6 XXXXX 00 (where XXXXX is the HDD password error code)
- 3 Press Enter to display the command options.
- 4 Select option 2 (upper case ASCII code), then press Enter.
- 5 Write down the generated master password.
- 6 Reboot the computer.
- 7 In the HDD password prompt, type the master password generated in [step 5](#), then press Enter.



CHAPTER 3

Replacing notebook components

- Preventing static electricity discharge
- Preparing the work space
- Required tools
- Preparing the notebook
- Removing the battery
- Replacing the hard drive
- Replacing the wireless card
- Adding or replacing memory modules
- Replacing the optical drive
- Replacing the palm rest module
- Replacing the touchpad board
- Replacing the keyboard
- Replacing the speakers
- Replacing the power button board
- Replacing the USB board
- Replacing the Bluetooth module
- Replacing the system board
- Replacing the cooling assembly
- Replacing the processor
- Replacing the LCD panel assembly
- Replacing the LCD front panel
- Replacing the webcam
- Replacing the LCD panel
- Replacing the LCD panel hinge brackets
- Replacing the microphone
- Replacing the antennas
- Replacing the LCD assembly lid

Preventing static electricity discharge



Warning

To avoid exposure to dangerous electrical voltages and moving parts, turn off your notebook, remove the battery, and unplug the power cord and network cable before opening the case.



Warning

To prevent risk of electric shock, do not insert any object into the vent holes of the notebook.



Important

Before performing maintenance on the notebook, you should read and understand the information in this section.

The components inside your notebook are extremely sensitive to static electricity, also known as *electrostatic discharge* (ESD).

Before performing maintenance on the notebook, follow these guidelines:

- Avoid static-causing surfaces such as carpeted floors, plastic, and packing foam.
- Remove components from their antistatic bags only when you are ready to use them. Do not lay components on the outside of antistatic bags because only the inside of the bags provide electrostatic protection.
- Always hold components by their edges. Avoid touching the edge connectors. Never slide components over any surface.
- Wear a grounding wrist strap (available at most electronics stores) and attach it to a bare metal part of your workbench or other grounded connection.
- Touch a bare metal surface on your workbench or other grounded object.

Tape

Some of the procedures in this guide involve removing tape that secures cables or components. Two types of tape are used in this notebook:

- Mylar, non-conductive tape is typically transparent, with a red or brown tint.
- Conductive tape is typically grey or silver in color.

If the existing tape cannot be reused, replace it with the same type. Make sure the replacement tape is of the non-ESD generating kind. Do not use cellophane tape.

Preparing the work space

Before performing maintenance on the notebook, make sure that your work space and the notebook are correctly prepared.

- Wear a grounding (ESD) wrist strap, and use a grounded or dissipative work mat.
- Use a sturdy table. Make sure that the table top is wide enough to hold each component as you remove it.
- Ensure that clear lighting condition is available to make part identification easier.
- Keep your work surface free from clutter and debris that may damage components.
- Use a magnetized screwdriver for removing screws.
- When removing components that are attached to the notebook by a cable, unplug the cable before removing the screws, when possible, to avoid damaging the cable.
- As you remove components and screws, lay them toward the rear of your work surface (behind the notebook) or far enough to the side that your arms will not accidentally brush them onto the floor.
- To help keep track of screws, try the following:
 - Place each component's screws in their own section of a parts sorter.
 - Place each component's screws next to the component on your work surface.
 - Print the first page of each task, then place the page toward the rear of your work surface. As you remove screws, place the screws in their respective section on the page.
 - After loosening screws that are deeply recessed in a hole (for example, on the bottom of the base assembly), you can leave the screws in the holes if you place small pieces of masking tape over the hole openings. When reassembling the component, just remove the tape and tighten the screws.
 - When you place flat-headed screws on the work surface, stand them on their heads to prevent the screws from rolling off the table.

Required tools

To disassemble the notebook, you need the following tools:

- Wrist grounding strap (for ESD prevention)



- Conductive mat (for ESD prevention)

- Flat screwdriver



- Phillips screwdriver



- Non-marring plastic scribe



Preparing the notebook

- ▶ To prepare the notebook for maintenance:
 - 1 Make sure that the optical disc drive is empty.
 - 2 Turn off the notebook.
 - 3 Close the LCD panel.
 - 4 Disconnect the AC adapter.



- 5 Disconnect the network cable and all peripheral devices connected to the notebook.
- 6 Make sure there is no memory card on the card reader slot. To remove a memory card:
 - a Push against the card, as if you were pushing it further into the slot, letting the card spring out
 - b Pull the memory card out of its slot.



Removing the battery

► To remove the battery:

- 1 Turn the notebook over so the base is facing up.
- 2 Slide the battery release latch.
- 3 Remove the battery out of the notebook.

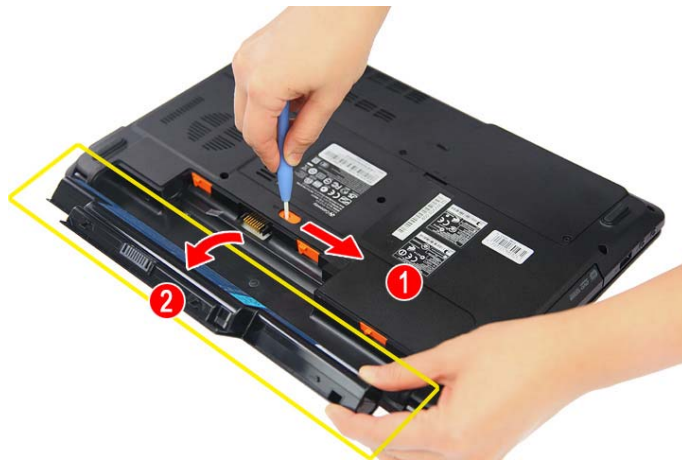

Note

The battery is highlighted with a yellow rectangle in the above image. Follow local regulations for battery disposal.



Removing the bay cover

To remove or replace components located on the lower bay, you need to remove the bay cover first.

Tools you need to complete this task:



Phillips #0 screwdriver



Non-marring plastic scribe

Screws removed during this task:

-  3 black M2.5x6 (bay cover)

► To remove the bay cover:

- 1 Complete the steps in [“Preparing the notebook” on page 37](#).
- 2 Turn the notebook over so the base is facing up.
- 3 Remove the bay cover screws.



- 4 Insert a non-marring plastic scribe on the cover's notch to release the cover from the computer, and then remove the cover.



Replacing the hard drive

Tools you need to complete this task:





Phillips #0 screwdriver



Non-marring plastic scribe

Screws removed during this task:

-  3 black M2.5x6 (bay cover)
-  1 black M2x3 (hard drive)
-  2 chrome M3x4 (hard drive bracket)

► To replace the hard drive:

- 1 Complete the steps in [“Preparing the notebook”](#) on page 37.
- 2 Complete the steps in [“Removing the bay cover”](#) on page 39.
- 3 Remove the hard drive screw.



- 4 Grasp the black mylar tab and use it to disengage the hard drive from its connector, and then remove the drive from its compartment.



- 5 If your new hard drive already includes the hard drive bracket, go to [step 8](#). If you need to use the bracket from the old hard drive, go to [step 6](#).
- 6 Remove the screws that secure the hard drive bracket, and then detach the drive from the bracket.

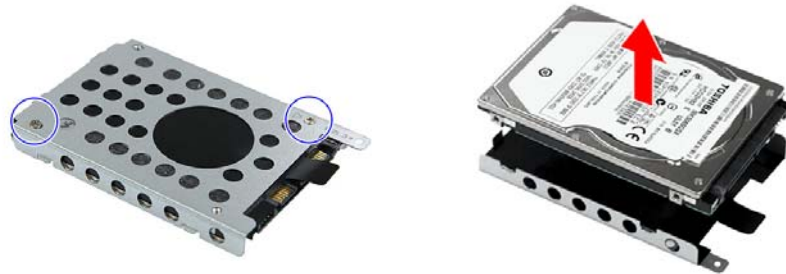

- 7 Place the bracket on the new drive and secure it with the two screws removed in [step 6](#).
- 8 Slide the new hard drive into the hard drive compartment and make sure it's properly engaged to the SATA1 connector.
- 9 Secure the new drive to the base with the screw removed in [step 6](#).
- 10 Reinstall the bay cover.



Replacing the wireless card

Tools you need to complete this task:





Phillips #0 screwdriver



Non-marring plastic scribe

Screws removed during this task:

-  3 black M2.5x6 (bay cover)
-  1 black M2x3 (wireless card)

► To replace the wireless card:

- 1 Complete the steps in [“Preparing the notebook” on page 37](#).
- 2 Complete the steps in [“Removing the bay cover” on page 39](#).
- 3 Detach the barcode sticker.
- 4 Unplug the antenna cables. Note which color cable corresponds to each of the connectors.



Important

The number of antenna cables varies depending on the type of wireless card installed on the notebook. IEEE 802.11n cards typically have three antenna cables. Other types of wireless cards usually have only two antenna cables.



- 5 Move the antenna cables away from the wireless card screw.

- 6 Remove the screw securing the wireless card.



- 7 Pull the card out of the slot.



- 8 Insert the new wireless card at a 30° angle into the empty Mini Card slot. The card is keyed so it can only be inserted in one direction. If the card does not fit, make sure that the notch in the card lines up with the tab in the card slot.
- 9 Secure the new wireless card with the screw removed in [step 6](#).
- 10 Reconnect the antenna cables to the connectors.
- 11 Reinstall the bay cover.



Adding or replacing memory modules

✓ Important

Use only memory modules designed for this notebook.

Tools you need to complete this task:



Screws removed during this task:

- 3 black M2.5x6 (bay cover)
- To add or replace memory modules:
- 1 Complete the steps in [“Preparing the notebook”](#) on page 37.
 - 2 Complete the steps in [“Removing the bay cover”](#) on page 39.
 - 3 If you are replacing a memory module, go to [step 4](#).
If you installing an additional memory module, go to [step 5](#).
 - 4 Use a non-marring plastic scribe to push out the latches on both sides of the memory slot until the module tilts upward (1), and then remove the memory module from its slot (2).



- 5 Insert the new memory module at a 30° angle into an empty memory slot, and then press it down until it clicks into place.
The module is keyed so it can only be inserted in one direction. If the module does not fit, make sure that the notch in the module lines up with the tab in the memory slot.
- 6 Reinstall the bay cover.



Replacing the optical drive

Tools you need to complete this task:





Phillips #0 screwdriver



Non-marring plastic scribe

Screws removed during this task:

-  1 black M2.5x6 (optical drive)
-  1 black M2x3 (optical drive bracket)

► To replace the optical drive:

- 1 Complete the steps in [“Preparing the notebook” on page 37](#).
- 2 Complete the steps in [“Removing the battery” on page 38](#).
- 3 Remove the optical drive screw.



- 4 Use the non-marring plastic scribe to carefully push the optical drive out of the drive bay **(1)**, and then slide the drive out **(2)**.

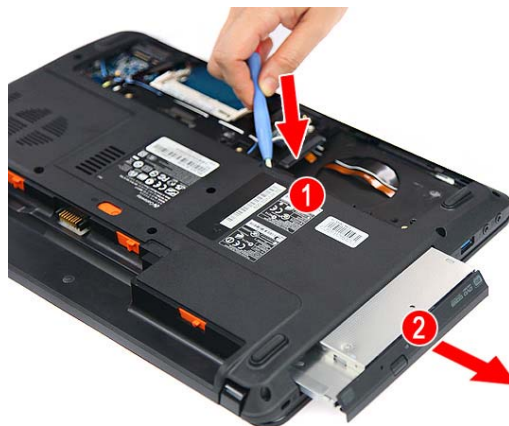

- 5 If your new optical drive already has its own bracket and bezel, go to [step 10](#). If you need to use the bezel and bracket from the old optical drive, perform [steps 6 – 9](#) as necessary.
- 6 Detach the bezel from the old optical drive.



- 7 Remove the screw that secures the optical drive bracket, and then detach the bracket from the drive.



- 8 Attach the bezel to the new optical drive.
- 9 Attach the bracket to the new optical drive and secure it with the screw removed in [step 7](#).
- 10 Slide the new optical drive into the drive bay and make sure it's properly engaged to the ODD1 connector.
- 11 Secure the new drive to the system board with the screw removed in [step 3](#).
- 12 Reinstall the battery.



Replacing the palm rest module

Tools you need to complete this task:



Phillips #0 screwdriver













Flat screwdriver

or



Non-marring plastic scribe

Screws removed during this task:

-  3 black M2.5x6 (bay cover)
-  1 black M2x3 (hard drive)
-  1 black M2.5x6 (optical drive)
-         9 black M2.5x6 (palm rest - base side)

► To replace the palm rest:

- 1 Complete the steps in [“Preparing the notebook” on page 37](#).
- 2 Complete the steps in [“Removing the battery” on page 38](#).
- 3 Complete the steps in [“Removing the bay cover” on page 39](#).
- 4 Remove the hard drive screw, and then remove the hard drive from its compartment.



- 5 If the notebook has a wireless card installed, unplug the antenna cables.

- 6 Release the antenna cables from its latches.

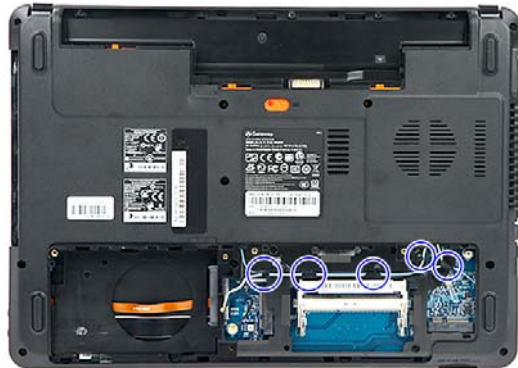

- 7 Remove the optical drive screw, and then remove the optical drive.



- 8 Remove the screws securing the palm rest on the base side.

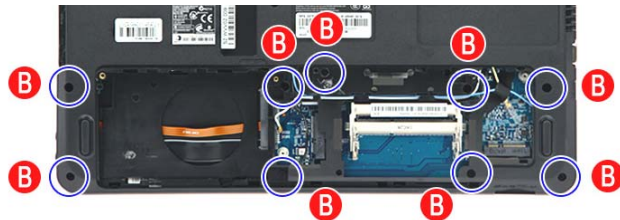

- 9 Locate the small gaps on the bottom side of the palm rest and insert a small flat-blade screwdriver or non-marring scribe into each gap to separate the palm rest from the base enclosure.
- 10 Once the bottom side is separated, pry loose the left and right sides of the palm rest, until all the palm rest retaining tabs have been released.
- 11 Flip the palm rest module over **(1)** .
- 12 Unlock the touchpad cable connector **(2)** and remove the touchpad cable **(3)**.
- 13 Lift the palm rest module from the base enclosure **(4)**.



- 14 Reconnect the touchpad cable to its system board connector.
- 15 Place the new palm rest assembly on top of the base enclosure and press it down on all sides until it snaps into place.
- 16 Close the LCD panel and turn the notebook over so the base is facing up.
- 17 Secure the palm rest assembly with the screws removed in [step 8](#).
- 18 Reinstall the optical drive by performing [steps 10 and 11](#) of the “[Replacing the optical drive](#)” procedure on [page 46](#).
- 19 Reinstall the hard drive by performing [steps 8 and 9](#) of the “[Replacing the hard drive](#)” procedure on [page 41](#).
- 20 If you have disconnected any wireless antennas, reconnect them now.
- 21 Reinstall the bay cover.
- 22 Reinstall the battery.



Replacing the touchpad board

Tools you need to complete this task:

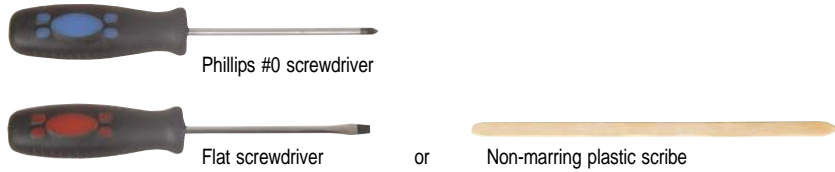

Screws removed during this task:

- 3 black M2.5×6 (bay cover)
- 1 black M2×3 (hard drive)
- 1 black M2.5×6 (optical drive)
- 9 black M2.5×6 (palm rest - base side) - Indicated by A in [step 8](#) of the [“Replacing the palm rest module”](#) procedure on [page 48](#)

► To replace the touchpad board:

- 1 Complete the steps in [“Preparing the notebook”](#) on [page 37](#).
- 2 Complete the steps in [“Removing the battery”](#) on [page 38](#).
- 3 Remove the hard drive by performing [steps 3](#) and [4](#) of the [“Replacing the hard drive”](#) procedure on [page 41](#).
- 4 Remove the optical drive by performing [steps 3](#) and [4](#) of the [“Replacing the optical drive”](#) procedure on [page 46](#).
- 5 Remove the palm rest by performing [steps 8 – 13](#) of the [“Replacing the palm rest module”](#) procedure on [page 48](#).
- 6 Note the orientation of the touchpad board for later reference in installing the new touchpad board.
- 7 Insert a small flat-blade screwdriver or non-marring scribe between the touchpad board and the palm rest’s underside, and carefully pry the board loose.
- 8 Remove the touchpad board from the palm rest.





Note

A circuit board that is $>10 \text{ cm}^2$ has been highlighted with a yellow rectangle as shown in the above image. Follow the local regulations for disposing this type of circuit board.

- 9 Observing the same orientation as the old touchpad board, secure the new board on the palm rest.
- 10 Cover the new touchpad board with the double-sided tape.
- 11 Insert the touchpad cable to the touchpad board cable connector, and then close the clip to lock the cable in place.
- 12 Reinstall the palm rest module by performing [steps 14 – 17](#) of the “[Replacing the palm rest module](#)” procedure on [page 48](#).
- 13 Reinstall the optical drive by performing [steps 10](#) and [11](#) of the “[Replacing the optical drive](#)” procedure on [page 46](#).
- 14 Reinstall the hard drive by performing [steps 8](#) and [9](#) of the “[Replacing the hard drive](#)” procedure on [page 41](#).
- 15 If you have disconnected any wireless antennas, reconnect them now.
- 16 Reinstall the bay cover.
- 17 Reinstall the battery.



Replacing the keyboard







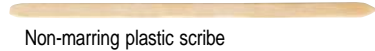





































Tools you need to complete this task:



or



Screws removed during this task:

-  3 black M2.5x6 (bay cover)
-  1 black M2x3 (hard drive)
-  1 black M2.5x6 (optical drive)
-      5 black M2x3 (keyboard frame - top base side) - Indicated by A in [step 8](#))
-               13 black M2.5x6 (keyboard frame/palm rest module - base side) - indicated by B in [step 8](#))
-             12 black M2x2 (keyboard frame) - indicated by A in [step 16](#))
-           10 black M1.4x3 (keyboard frame) - indicated by B in [step 16](#))

► To replace the keyboard:

- 1 Complete the steps in [“Preparing the notebook” on page 37.](#)



Caution

The keyboard is connected to the notebook through the keyboard cable. Disconnect this cable first before pulling the keyboard away from the palm rest.

- 2 Complete the steps in [“Removing the battery” on page 38.](#)
- 3 Complete the steps in [“Removing the bay cover” on page 39.](#)

- 4 Remove the hard drive screw, and then remove the hard drive from its compartment.



- 5 If the notebook has a wireless card installed, unplug the antenna cables.
- 6 Release the antenna cables from the latches securing them.



- 7 Remove the optical drive screw, and then remove the optical drive.



- 8 Remove the screws securing the palm rest and keyboard frame to the base side.

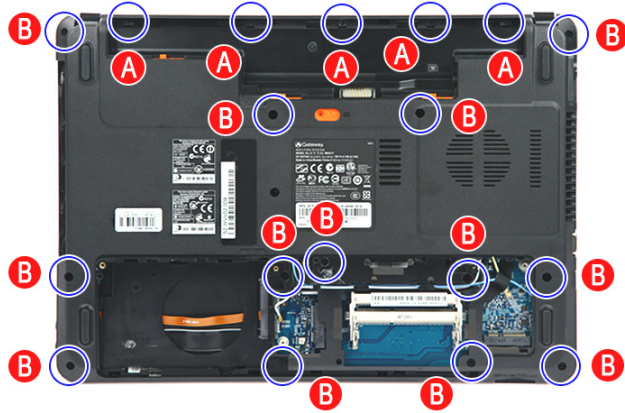

- 9 Remove the palm rest by performing [steps 9 – 13](#) of the “[Replacing the palm rest module](#)” procedure on [page 48](#).
- 10 Locate the small gaps on the top side of the keyboard frame and insert a small flat-blade screwdriver or non-marring scribe into each gap to separate the keyboard frame from the base enclosure.
- 11 Once the top side is separated, pry loose the left and right sides of the keyboard frame, until all the retaining tabs have been released.
- 12 Flip the keyboard over to access to the keyboard cable **(1)**.
- 13 Unlock the system board’s keyboard cable connector **(2)**, and then remove the cable **(3)**.

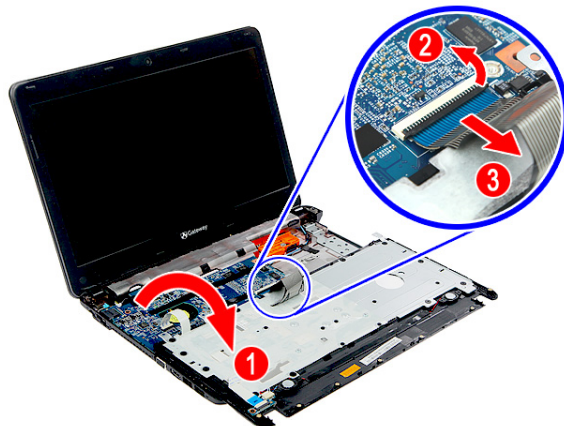

- 14 Unlock the system board's power button board cable connector, and then remove the cable.

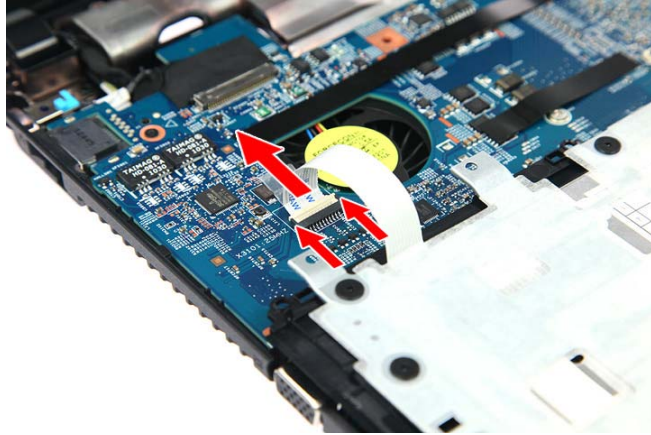

- 15 Lay the keyboard frame down.
- 16 Remove the screws securing the keyboard.

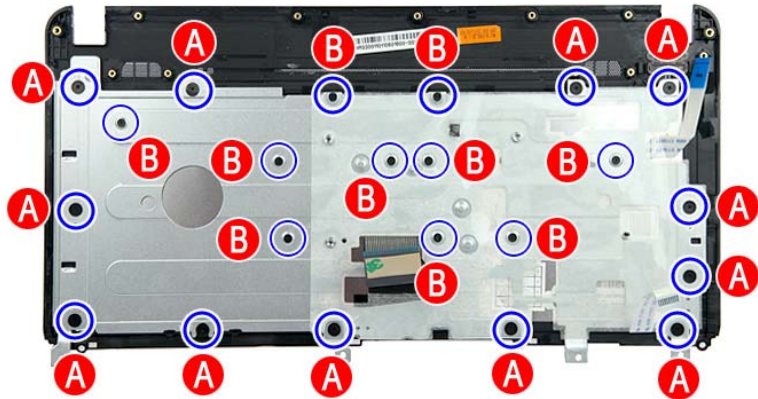

- 17 Lift the keyboard from the frame.

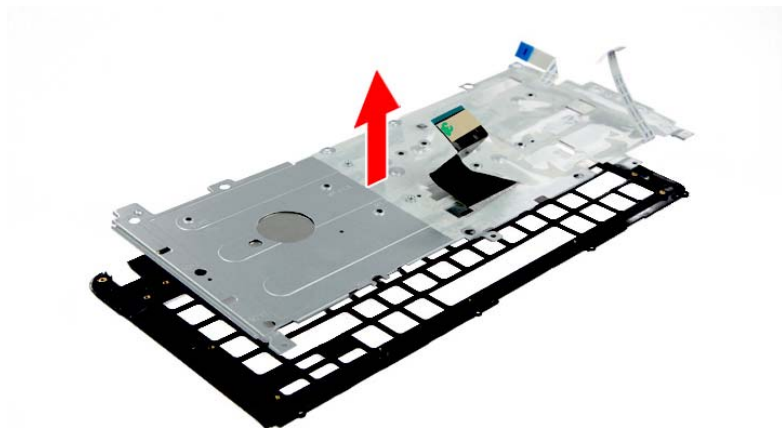

- 18 If your new keyboard already includes the keyboard frame, go to [step 21](#). If you need to use the keyboard frame from the old keyboard, go to [step 19](#).
- 19 Position the new keyboard on the keyboard frame.
- 20 Secure the keyboard with the screws removed in [step 16](#).
- 21 Lay the keyboard down and insert the keyboard cable to its system board connector, and then close the clip to lock the cable in place.



Important

The keyboard cable is correctly oriented if it is not twisted.

- 22 Flip the keyboard over and press it down on all sides until it snaps into place.
- 23 Close the LCD panel and turn the notebook over so the base is facing up.
- 24 Secure the keyboard frame with the screws removed in [step 8](#).
- 25 Reinstall the palm rest module by performing [steps 14 – 17](#) of the “[Replacing the palm rest module](#)” procedure on [page 48](#).
- 26 Reinstall the optical drive by performing [steps 10 and 11](#) of the “[Replacing the optical drive](#)” procedure on [page 46](#).
- 27 Reinstall the hard drive by performing [steps 8 and 9](#) of the “[Replacing the hard drive](#)” procedure on [page 41](#).
- 28 If you have disconnected any wireless antennas, reconnect them now.
- 29 Reinstall the bay cover.
- 30 Reinstall the battery.







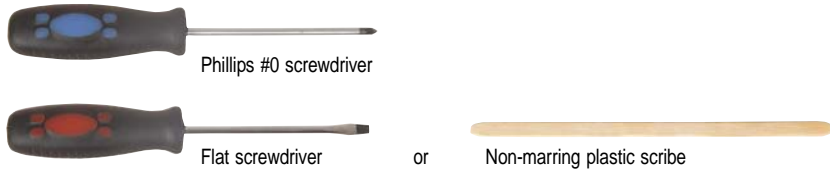





















Replacing the speakers

Tools you need to complete this task:



Screws removed during this task:

-  3 black M2.5x6 (bay cover)
-  1 black M2x3 (hard drive)
-  1 black M2.5x6 (optical drive)
-      5 black M2x3 (keyboard frame - top base side) - Indicated by A in [step 8](#) of the “[Replacing the keyboard](#)” procedure on [page 53](#)
-               13 black M2.5x6 (keyboard frame/palm rest module - base side) - indicated by B in [step 8](#) of the “[Replacing the keyboard](#)” procedure on [page 53](#)
-     4 black M2x3 (speakers)

► To replace the speakers:

- 1 Complete the steps in “[Preparing the notebook](#)” on [page 37](#).
- 2 Remove the hard drive by performing [steps 3 and 4](#) of the “[Replacing the hard drive](#)” procedure on [page 41](#).
- 3 Remove the optical drive by performing [steps 3 and 4](#) of the “[Replacing the optical drive](#)” procedure on [page 46](#).
- 4 Remove the palm rest by performing [steps 8 – 13](#) of the “[Replacing the palm rest module](#)” procedure on [page 48](#).
- 5 Remove the keyboard by performing [steps 10 – 14](#) of the “[Replacing the keyboard](#)” procedure on [page 53](#).

Caution

The keyboard is connected to the notebook through a keyboard cable. Disconnect this cable first before pulling the keyboard away from the palm rest assembly.

- 6 Lay the keyboard frame keys down.

- 7 Detach the mylar tape covering the speaker cable, and then release the speaker cable from the latches securing the cable.

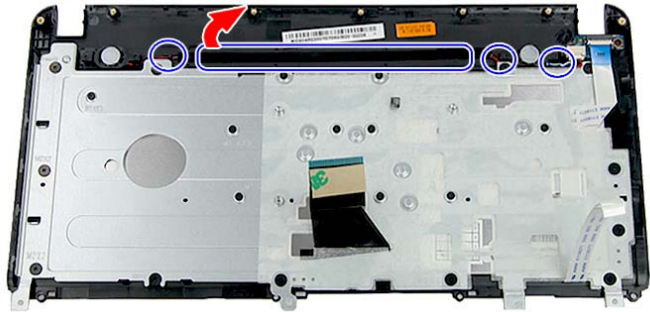

- 8 Disconnect the speaker cable from the power button board.

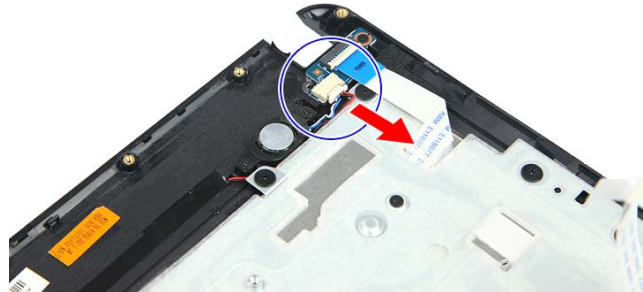

- 9 Remove the speaker screws, and then remove the speakers.



- 10 Position the new speakers on the keyboard frame.
- 11 Secure the speakers with the screws removed in [step 9](#).
- 12 Reconnect the speaker cable to the power button board.
- 13 Secure the speaker cable on the keyboard frame latches.
- 14 Cover the speaker cable with mylar tape.
- 15 Reinstall the keyboard by performing [steps 21 – 24](#) of the “[Replacing the keyboard](#)” procedure on [page 53](#).
- 16 Reinstall the palm rest module by performing [steps 14 – 17](#) of the “[Replacing the palm rest module](#)” procedure on [page 48](#).
- 17 Reinstall the optical drive by performing [steps 10 and 11](#) of the “[Replacing the optical drive](#)” procedure on [page 46](#).
- 18 Reinstall the hard drive by performing [steps 8 and 9](#) of the “[Replacing the hard drive](#)” procedure on [page 41](#).

CHAPTER 3: Replacing notebook components

- 19 If you have disconnected any wireless antennas, reconnect them now.
- 20 Reinstall the bay cover.
- 21 Reinstall the battery.







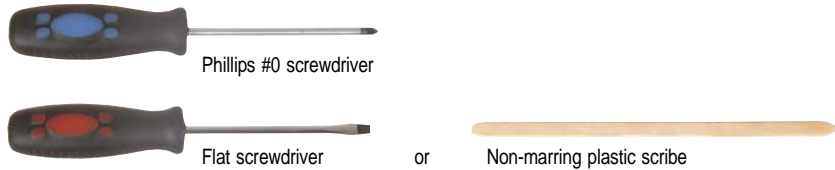

















Replacing the power button board

Tools you need to complete this task:



Screws removed during this task:

-  3 black M2.5×6 (bay cover)
 -  1 black M2×3 (hard drive)
 -  1 black M2.5×6 (optical drive)
 -      5 black M2×3 (keyboard frame - top base side) - Indicated by A in [step 8](#) of the “[Replacing the keyboard](#)” procedure on [page 53](#)
 -              13 black M2.5×6 (keyboard frame/palm rest module - base side) - indicated by B in [step 8](#) of the “[Replacing the keyboard](#)” procedure on [page 53](#)
 -  2 black M2×3 (power button board)
- To replace the power button board:
- 1 Complete the steps in “[Preparing the notebook](#)” on [page 37](#).
 - 2 Complete the steps in “[Removing the battery](#)” on [page 38](#).
 - 3 Remove the hard drive by performing steps 3 and 4 of the “[Replacing the hard drive](#)” procedure on [page 41](#).
 - 4 Remove the optical drive by performing steps 3 and 4 of the “[Replacing the optical drive](#)” procedure on [page 46](#).
 - 5 Remove the palm rest by performing [steps 8 – 13](#) of the “[Replacing the palm rest module](#)” procedure on [page 48](#).
 - 6 Remove the keyboard by performing [steps 10 – 14](#) of the “[Replacing the keyboard](#)” procedure on [page 53](#).



Caution

The keyboard is connected to the notebook through a keyboard cable. Disconnect this cable first before pulling the keyboard away from the palm rest assembly.

- 7 Lay the keyboard frame keys down.

- 8 Disconnect the speaker cable from the power board.
- 9 Unlock the power button board cable connector (1), and then remove the cable (2).



- 10 Remove the power button board screw, and then remove the old power button board from the keyboard frame.



- 11 Position the new power button board on the keyboard frame.
- 12 Secure the power button board with the screw removed in [step 10](#).
- 13 Insert the power button cable to the power button board cable connector, and then close the clip to lock the cable in place.
- 14 Reinstall the keyboard by performing [steps 21 – 24](#) of the “[Replacing the keyboard](#)” procedure on [page 53](#).
- 15 Reinstall the palm rest module by performing [steps 14 – 17](#) of the “[Replacing the palm rest module](#)” procedure on [page 48](#).
- 16 Reinstall the optical drive by performing [steps 10 and 11](#) of the “[Replacing the optical drive](#)” procedure on [page 46](#).
- 17 Reinstall the hard drive by performing [steps 8 and 9](#) of the “[Replacing the hard drive](#)” procedure on [page 41](#).
- 18 If you have disconnected any wireless antennas, reconnect them now.
- 19 Reinstall the bay cover.
- 20 Reinstall the battery.



Replacing the USB board

Tools you need to complete this task:



or

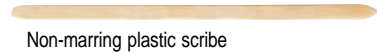

Screws removed during this task:

- 3 black M2.5×6 (bay cover)
- 1 black M2×3 (hard drive)
- 1 black M2.5×6 (optical drive)
- 9 black M2.5×6 (palm rest - base side) - Indicated by A in [step 8](#) of the “[Replacing the palm rest module](#)” procedure on [page 48](#)

► To replace the USB board:

- 1 Complete the steps in “[Preparing the notebook](#)” on [page 37](#).
- 2 Complete the steps in “[Removing the battery](#)” on [page 38](#).
- 3 Remove the hard drive by performing [steps 3 and 4](#) of the “[Replacing the hard drive](#)” procedure on [page 41](#).
- 4 Remove the optical drive by performing [steps 3 and 4](#) of the “[Replacing the optical drive](#)” procedure on [page 46](#).
- 5 Remove the palm rest by performing [steps 8 – 13](#) of the “[Replacing the palm rest module](#)” procedure on [page 48](#).
- 6 Unlock the two USB board cable connectors (1), and then remove the USB board cables (2).

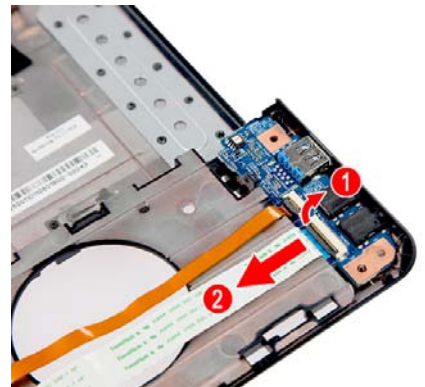

- 7 Remove the USB board from the tabs securing it.

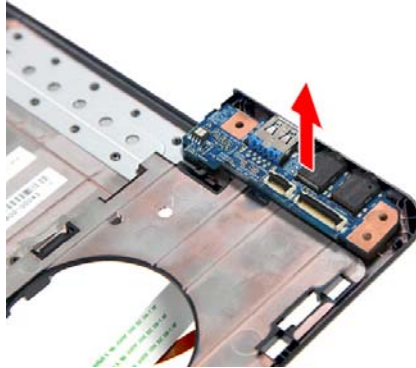

- 8 Place the new USB board in the base enclosure.
- 9 Reconnect the two USB board cables to the new USB board.
- 10 Reinstall the keyboard by performing [steps 21 – 24](#) of the “[Replacing the keyboard](#)” procedure on [page 53](#).
- 11 Reinstall the palm rest module by performing [steps 14 – 17](#) of the “[Replacing the palm rest module](#)” procedure on [page 48](#).
- 12 Reinstall the optical drive by performing [steps 10 and 11](#) of the “[Replacing the optical drive](#)” procedure on [page 46](#).
- 13 Reinstall the hard drive by performing [steps 8 and 9](#) of the “[Replacing the hard drive](#)” procedure on [page 41](#).
- 14 If you have disconnected any wireless antennas, reconnect them now.
- 15 Reinstall the bay cover.
- 16 Reinstall the battery.



Replacing the Bluetooth module

Tools you need to complete this task:



or

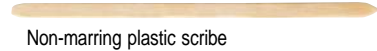

Screws removed during this task:

- 3 black M2.5×6 (bay cover)
- 1 black M2×3 (hard drive)
- 1 black M2.5×6 (optical drive)
- 9 black M2.5×6 (palm rest - base side) - Indicated by A in [step 8](#) of the “[Replacing the palm rest module](#)” procedure on [page 48](#)

► To replace the Bluetooth module:

- 1 Complete the steps in “[Preparing the notebook](#)” on [page 37](#).
- 2 Complete the steps in “[Removing the battery](#)” on [page 38](#).
- 3 Remove the hard drive by performing [steps 3 and 4](#) of the “[Replacing the hard drive](#)” procedure on [page 41](#).
- 4 Remove the optical drive by performing [steps 3 and 4](#) of the “[Replacing the optical drive](#)” procedure on [page 46](#).
- 5 Remove the palm rest by performing [steps 8 – 13](#) of the “[Replacing the palm rest module](#)” procedure on [page 48](#).
- 6 Disconnect the Bluetooth cable from its system board connector **(1)**, and then detach the Bluetooth module **(2)**.

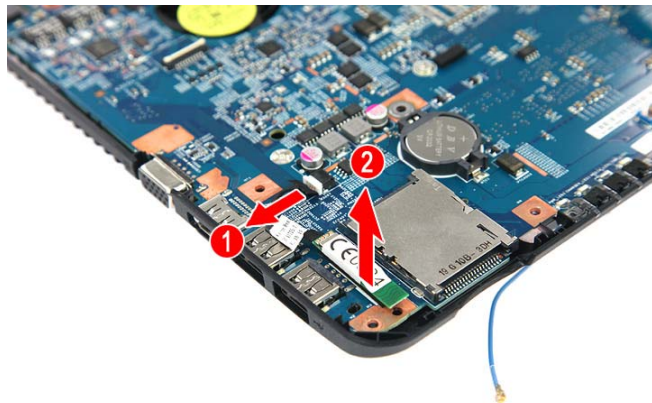

- 7 Place the new Bluetooth module on the system board and reconnect the Bluetooth cable to its system board connector.
- 8 Reinstall the keyboard by performing [steps 21 – 24](#) of the “[Replacing the keyboard](#)” procedure on [page 53](#).

- 9 Reinstall the palm rest module by performing [steps 14 – 17](#) of the “[Replacing the palm rest module](#)” procedure on [page 48](#).
- 10 Reinstall the optical drive by performing [steps 10 and 11](#) of the “[Replacing the optical drive](#)” procedure on [page 46](#).
- 11 Reinstall the hard drive by performing [steps 8 and 9](#) of the “[Replacing the hard drive](#)” procedure on [page 41](#).
- 12 If you have disconnected any wireless antennas, reconnect them now.
- 13 Reinstall the bay cover.
- 14 Reinstall the battery.







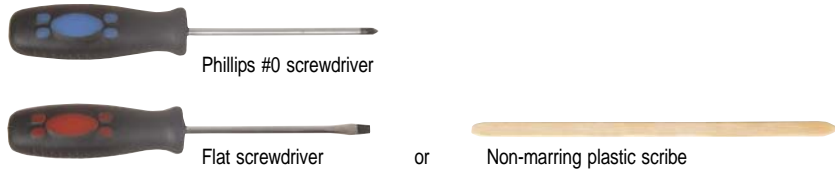

















Replacing the system board

Tools you need to complete this task:



Screws removed during this task:

-  3 black M2.5×6 (bay cover)
-  1 black M2×3 (hard drive)
-  1 black M2.5×6 (optical drive)
-      5 black M2×3 (keyboard frame - top base side) - Indicated by A in [step 8](#) of the “[Replacing the keyboard](#)” procedure on [page 53](#)
-              13 black M2.5×6 (keyboard frame/palm rest module - base side) - indicated by B in [step 8](#) of the “[Replacing the keyboard](#)” procedure on [page 53](#)
-  1 black M2×3 (system board)

► To replace the system board:

- 1 Complete the steps in “[Preparing the notebook](#)” on [page 37](#).
- 2 Complete the steps in “[Removing the battery](#)” on [page 38](#).
- 3 Remove the memory from the old system board and install it on the new system board by following the instructions in the “[Adding or replacing memory modules](#)” section on [page 45](#).
- 4 If the notebook has a wireless card installed, remove the card from the old system board and install it on the new system board by following the instructions in the “[Replacing the wireless card](#)” section on [page 43](#).
- 5 Remove the hard drive by performing [steps 3 and 4](#) of the “[Replacing the hard drive](#)” procedure on [page 41](#).
- 6 Remove the optical drive by performing [steps 3 and 4](#) of the “[Replacing the optical drive](#)” procedure on [page 46](#).
- 7 Remove the palm rest by performing [steps 8 – 13](#) of the “[Replacing the palm rest module](#)” procedure on [page 48](#).
- 8 Remove the keyboard by performing [steps 10 – 14](#) of the “[Replacing the keyboard](#)” procedure on [page 53](#).



Caution

The keyboard is connected to the notebook through a keyboard cable. Disconnect this cable first before pulling the keyboard away from the palm rest assembly.

- 9 Remove USB board by performing [steps 6 and 7](#) of the “[Replacing the USB board](#)” procedure on [page 63](#).
- 10 Remove the Bluetooth module by performing [step 6](#) of the “[Replacing the Bluetooth module](#)” procedure on [page 65](#).
- 11 Unlock the two USB board cable connectors **(1)**, and then remove the USB board cables from their system board connectors **(2)**.

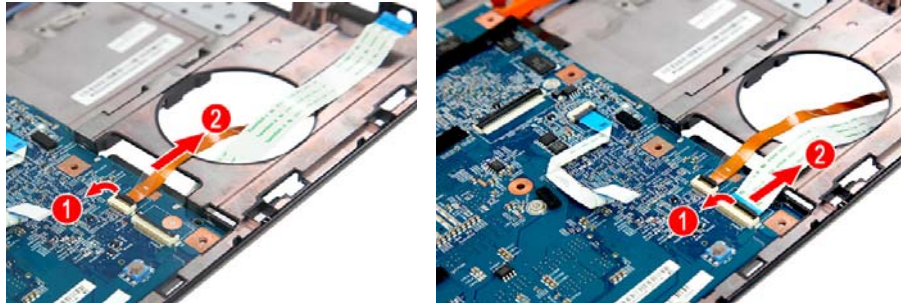

- 12 Disconnect the LCD cable from its system board connector.

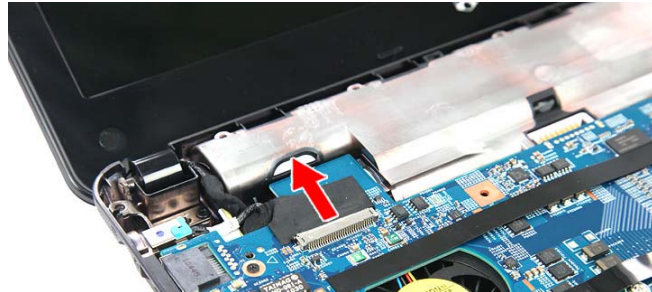

- 13 Remove the system board screw.



Note

A circuit board that is $>10\text{ cm}^2$ has been highlighted with a yellow rectangle as shown in the previous image. Follow the local regulations for disposing this type of circuit board.

The RTC battery has been highlighted with a yellow box in the previous image. Detach the RTC battery and follow the local regulations for disposing it.

- 14 Carefully pull the system board out of the base enclosure, and then flip it over **(1)**.
- 15 Disconnect the DC-input cable from its system board connector **(2)**, and then remove the system board **(3)**.

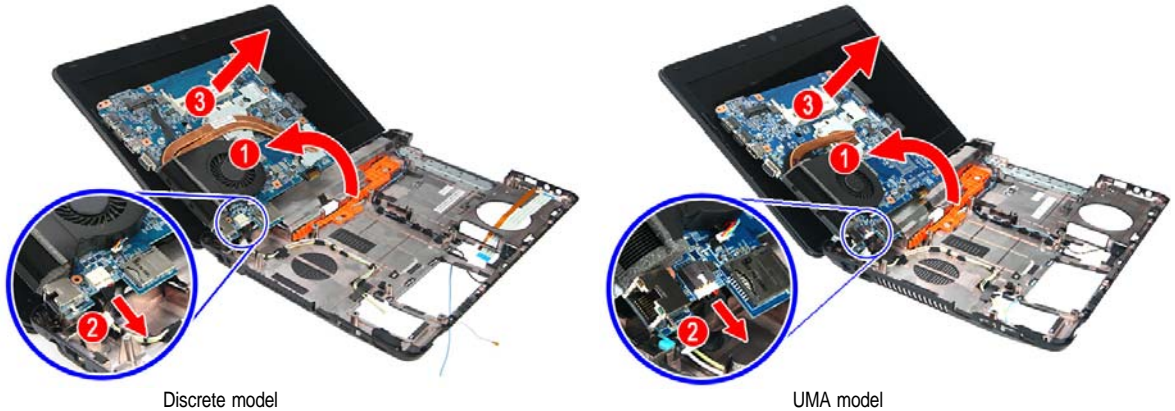

- 16 Remove the cooling assembly by performing [steps 4 – 7](#) of the “[Replacing the cooling assembly](#)” procedure on [page 70](#).
- 17 If your new system board does not include a processor, remove the processor from the old system board and install it on the new system board by performing [steps 5 and 6](#) in the “[Replacing the processor](#)” section on [page 73](#).
- 18 Reinstall the cooling assembly by performing [steps 8 – 11](#) of the “[Replacing the cooling assembly](#)” procedure on [page 70](#).
- 19 Place the new system board in the base enclosure and secure it with the screw removed in [step 13](#).
- 20 Reconnect the DC-input, LCD and USB board cables to their system board connectors.
- 21 Reinstall the USB board by performing [steps 8 – 9](#) of the “[Replacing the USB board](#)” procedure on [page 63](#).
- 22 Reinstall the Bluetooth module by performing [step 7](#) of the “[Replacing the Bluetooth module](#)” procedure on [page 65](#).
- 23 Reinstall the keyboard by performing [steps 21 – 24](#) of the “[Replacing the keyboard](#)” procedure on [page 53](#).
- 24 Reinstall the palm rest module by performing [steps 14 – 17](#) of the “[Replacing the palm rest module](#)” procedure on [page 48](#).
- 25 Reinstall the optical drive by performing [steps 10 and 11](#) of the “[Replacing the optical drive](#)” procedure on [page 46](#).
- 26 Reinstall the hard drive by performing [steps 8 and 9](#) of the “[Replacing the hard drive](#)” procedure on [page 41](#).
- 27 If you have disconnected any wireless antennas, reconnect them now.
- 28 Reinstall the bay cover.
- 29 Reinstall the battery.



Replacing the cooling assembly

Tools you need to complete this task:

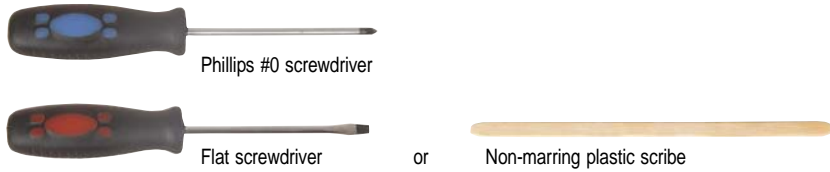

Additional materials you need to complete this task:

- Soft cloth and isopropyl alcohol; or alcohol pad
- Thermal grease

Screws removed during this task:

- 3 black M2.5x6 (bay cover)
- 1 black M2x3 (hard drive)
- 1 black M2.5x6 (optical drive)
- 5 black M2x3 (keyboard frame - top base side) - Indicated by A in [step 8](#) of the “[Replacing the keyboard](#)” procedure on [page 53](#)
- 13 black M2.5x6 (keyboard frame/palm rest module - base side) - indicated by B in [step 8](#) of the “[Replacing the keyboard](#)” procedure on [page 53](#)
- 1 black M2x3 (system board)

► To replace the cooling assembly:

- 1 Complete the steps in “[Preparing the notebook](#)” on [page 37](#).
- 2 Remove the system board by performing steps 1 – 15 of the “[Replacing the system board](#)” procedure on [page 67](#).
- 3 Turn the system board over to access the cooling fan cable.
- 4 Disconnect the cooling fan cable from its system board connector.

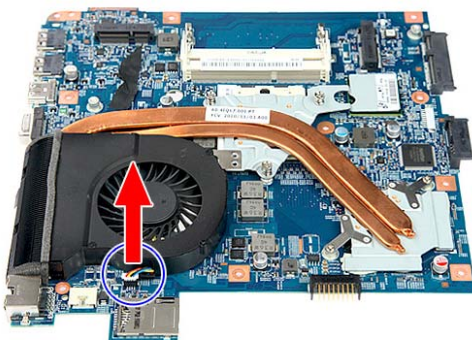

Discrete model

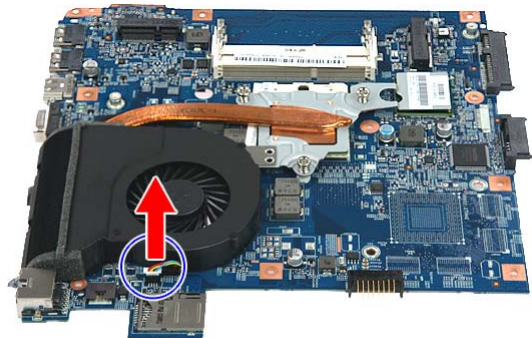

UMA model

- 5 Loosen the spring-loaded captive screws securing the cooling assembly. Follow the screw sequence indicated on the below images.

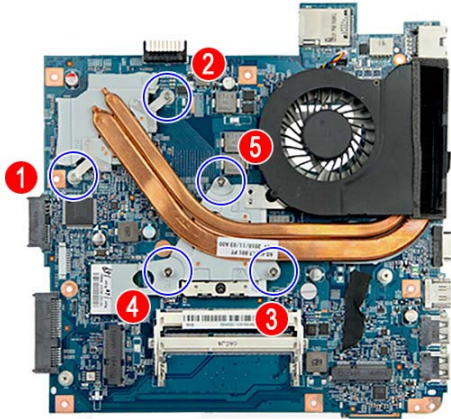

Discrete model

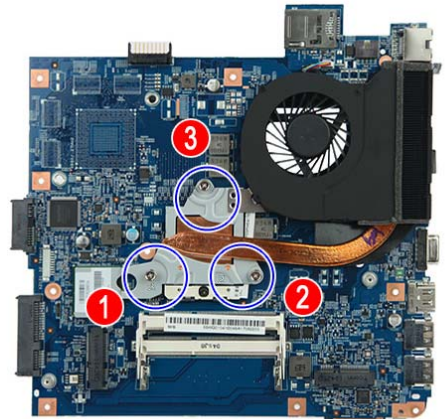

UMA model

- 6 Remove the cooling assembly from the system board.

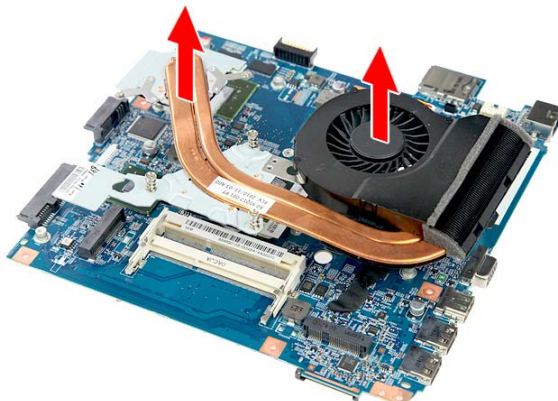

Discrete model

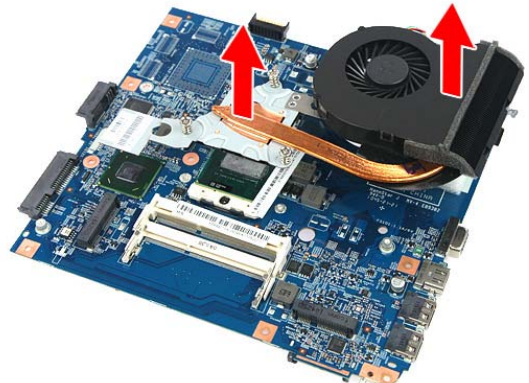

UMA model

- 7 Lay the cooling assembly down in an upright position to avoid tainting your work space with thermal grease.
- 8 Moisten a soft cloth with isopropyl alcohol and clean the processor die to remove any thermal grease residue. Wipe the die surface several times to make sure that no particles or dust contaminants are evident. Allow the alcohol to evaporate before continuing.



Caution

Do not touch the contact surface of the new cooling assembly nor the processor die as this may leave dead skin cells or oils from your finger that can result in poor thermal grease performance.

- 9 Apply just enough thermal grease to evenly coat the surface of the processor die.
- 10 Place the new cooling assembly on the system board and tighten its captive screws to secure it in place. Follow the sequence of the number beside each screw when securing the cooling assembly.

- 11 Reconnect the cooling fan cable to its system board connector.
- 12 Reconnect the DC input cable to its system board connector.
- 13 Reinstall the system board by performing [steps 19](#) and [20](#) of the “[Replacing the system board](#)” procedure on [page 67](#).
- 14 Reconnect the LCD, USB board and Bluetooth module cables to their system board connectors.
- 15 Reinstall the Bluetooth module by performing [step 7](#) of the “[Replacing the Bluetooth module](#)” procedure on [page 65](#).
- 16 Reinstall the USB board by performing [steps 8 – 9](#) of the “[Replacing the USB board](#)” procedure on [page 63](#).
- 17 Reinstall the keyboard by performing [steps 21 – 24](#) of the “[Replacing the keyboard](#)” procedure on [page 53](#).
- 18 Reinstall the palm rest module by performing [steps 14 – 17](#) of the “[Replacing the palm rest module](#)” procedure on [page 48](#).
- 19 Reinstall the optical drive by performing [steps 10](#) and [11](#) of the “[Replacing the optical drive](#)” procedure on [page 46](#).
- 20 Reinstall the hard drive by performing [steps 8](#) and [9](#) of the “[Replacing the hard drive](#)” procedure on [page 41](#).
- 21 If you have disconnected any wireless antennas, reconnect them now.
- 22 Reinstall the bay cover.
- 23 Reinstall the battery.



Replacing the processor



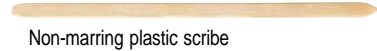



















Tools you need to complete this task:



Additional materials you need to complete this task:

- Soft cloth and isopropyl alcohol; or alcohol pad
- Thermal grease

Screws removed during this task:

-  3 black M2.5x6 (bay cover)
-  1 black M2x3 (hard drive)
-  1 black M2.5x6 (optical drive)
-      5 black M2x3 (keyboard frame - top base side) - Indicated by A in [step 8](#) of the ["Replacing the keyboard"](#) procedure on [page 53](#)
-              13 black M2.5x6 (keyboard frame/palm rest module - base side) - indicated by B in [step 8](#) of the ["Replacing the keyboard"](#) procedure on [page 53](#)
-  1 black M2x3 (system board)

► To replace the processor:

- 1 Complete the steps in ["Preparing the notebook"](#) on [page 37](#).
- 2 Remove the system board by performing [steps 1 – 15](#) of the ["Replacing the system board"](#) procedure on [page 67](#).
- 3 Remove the cooling assembly by performing [steps 4 – 7](#) of the ["Replacing the cooling assembly"](#) procedure on [page 70](#).
- 4 Remove the barcode sticker on top of the processor.

- 5 Use a flat-blade screwdriver to turn the processor lock screw counter-clockwise **(1)**.
- 6 Remove the old processor from the system board **(2)**.

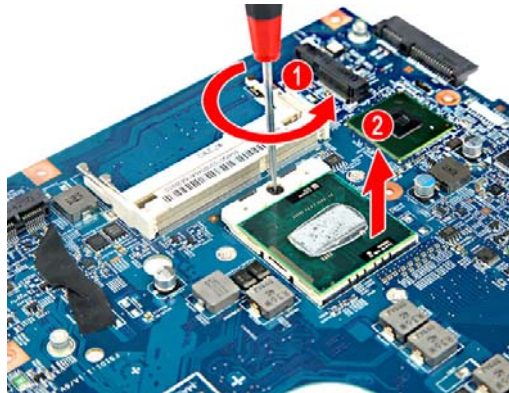

- 7 Align pin 1 of the new processor (indicated by the gold arrow on the corner of the processor) with the beveled corner of the processor socket. The processor will easily fit into the socket if you oriented it properly.



- 8 Use a flat-blade screwdriver to turn the lock screw 180° clockwise to secure the processor in place.
- 9 Apply just enough thermal grease to evenly coat the surface of the processor die.
- 10 Reinstall the cooling assembly by performing [steps 10 – 11](#) of the “[Replacing the cooling assembly](#)” procedure on [page 70](#).
- 11 Reinstall the system board by performing [steps 19 and 20](#) of the “[Replacing the system board](#)” procedure on [page 67](#).
- 12 Reconnect the LCD, USB board and Bluetooth module cables to their system board connectors.
- 13 Reinstall the Bluetooth module by performing [step 7](#) of the “[Replacing the Bluetooth module](#)” procedure on [page 65](#).
- 14 Reinstall the USB board by performing [steps 8 – 9](#) of the “[Replacing the USB board](#)” procedure on [page 63](#).
- 15 Reinstall the keyboard by performing [steps 21 – 24](#) of the “[Replacing the keyboard](#)” procedure on [page 53](#).
- 16 Reinstall the palm rest module by performing [steps 14 – 17](#) of the “[Replacing the palm rest module](#)” procedure on [page 48](#).

- 17 Reinstall the optical drive by performing [steps 10 and 11](#) of the “[Replacing the optical drive](#)” procedure on [page 46](#).
- 18 Reinstall the hard drive by performing [steps 8 and 9](#) of the “[Replacing the hard drive](#)” procedure on [page 41](#).
- 19 If you have disconnected any wireless antennas, reconnect them now.
- 20 Reinstall the bay cover.
- 21 Reinstall the battery.







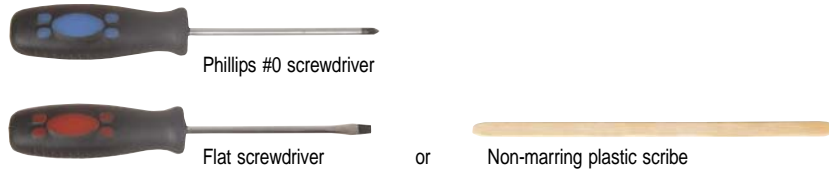





















Replacing the LCD panel assembly

Tools you need to complete this task:



Screws removed during this task:

-  3 black M2.5x6 (bay cover)
-  1 black M2x3 (hard drive)
-  1 black M2.5x6 (optical drive)
-      5 black M2x3 (keyboard frame - top base side) - Indicated by A in [step 8](#) of the “[Replacing the keyboard](#)” procedure on [page 53](#)
-               13 black M2.5x6 (keyboard frame/palm rest module - base side) - indicated by B in [step 8](#) of the “[Replacing the keyboard](#)” procedure on [page 53](#)
-  1 black M2x3 (system board)
-     4 black M2.5x6 (LCD panel hinges)

► To replace the LCD panel assembly:

- 1 Complete the steps in “[Preparing the notebook](#)” on [page 37](#).
- 2 If the notebook has a wireless card installed, complete the steps in “[Removing the bay cover](#)” on [page 39](#), and then unplug the antenna cables. If there’s no wireless card installed, proceed to [step 3](#).
- 3 Remove the hard drive by performing [steps 3](#) and [4](#) of the “[Replacing the hard drive](#)” procedure on [page 41](#).
- 4 Remove the optical drive by performing [steps 3](#) and [4](#) of the “[Replacing the optical drive](#)” procedure on [page 46](#).
- 5 Remove the palm rest by performing [steps 8 – 13](#) of the “[Replacing the palm rest module](#)” procedure on [page 48](#).
- 6 Remove the keyboard by performing [steps 10 – 14](#) of the “[Replacing the keyboard](#)” procedure on [page 53](#).

Caution

The keyboard is connected to the notebook through a keyboard cable. Disconnect this cable first before pulling the keyboard away from the palm rest assembly.

- 7 Remove the system board by performing [steps 1 – 15](#) of the “[Replacing the system board](#)” procedure on [page 67](#).

- 8 If the notebook has a wireless card installed, note the antenna cable routing for later reference and then perform [step 9](#) to release the antenna cables from the palm rest.
- 9 Release the antenna cables from the adhesive tabs and latches securing them.

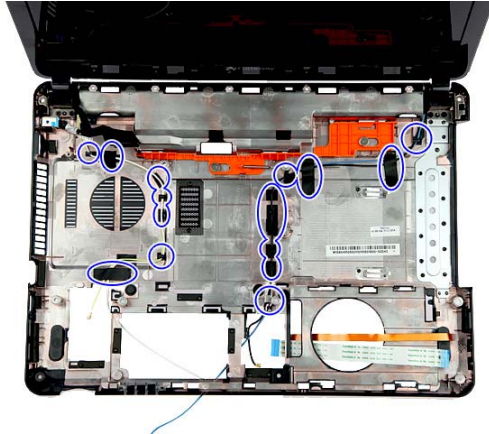

- 10 Carefully open the LCD panel to its fully extended position.
- 11 Remove the LCD hinge screws securing the LCD assembly.

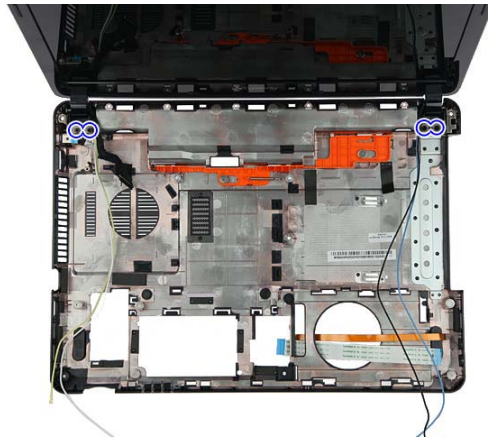

- 12 Lift the LCD panel assembly up and away from the notebook.

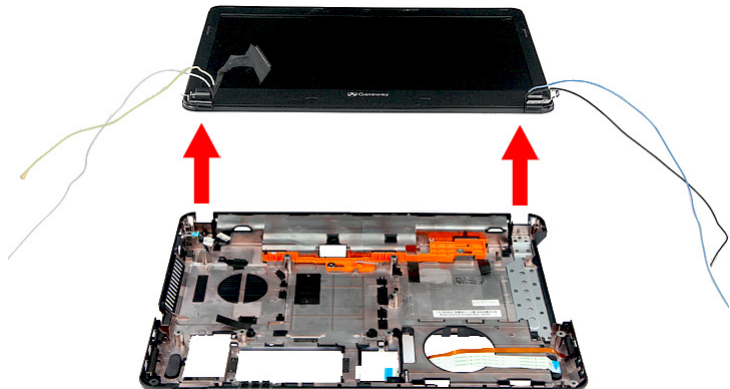

- 13 Position the new LCD panel assembly on the notebook, and then secure it with the hinge screws removed in [step 11](#).
- 14 If the notebook has a wireless card installed, proceed to [step 15](#) to arrange the antenna cables.
- 15 Refer to the antenna cable routing note made on [step 9](#) and secure the antenna cables to the base enclosure before pulling the ends downward to the wireless card compartment.
- 16 Reinstall the system board by performing [steps 19](#) and [20](#) of the “[Replacing the system board](#)” procedure on [page 67](#).
- 17 Reinstall the keyboard by performing [steps 21](#) – [24](#) of the “[Replacing the keyboard](#)” procedure on [page 53](#).
- 18 Reinstall the palm rest module by performing [steps 14](#) – [17](#) of the “[Replacing the palm rest module](#)” procedure on [page 48](#).
- 19 Reinstall the optical drive by performing [steps 10](#) and [11](#) of the “[Replacing the optical drive](#)” procedure on [page 46](#).
- 20 Reinstall the hard drive by performing [steps 8](#) and [9](#) of the “[Replacing the hard drive](#)” procedure on [page 41](#).
- 21 If you have disconnected any wireless antennas, reconnect them now.
- 22 Reinstall the bay cover.
- 23 Reinstall the battery.



Replacing the LCD front panel







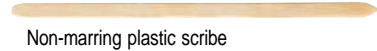





















Tools you need to complete this task:



or



Screws removed during this task:

-  3 black M2.5×6 (bay cover)
-  1 black M2×3 (hard drive)
-  1 black M2.5×6 (optical drive)
-      5 black M2×3 (keyboard frame - top base side) - Indicated by A in [step 8](#) of the “[Replacing the keyboard](#)” procedure on [page 53](#)
-              13 black M2.5×6 (keyboard frame/palm rest module - base side) - indicated by B in [step 8](#) of the “[Replacing the keyboard](#)” procedure on [page 53](#)
-  1 black M2×3 (system board)
-     4 black M2.5×6 (LCD panel hinges)
-   2 black M2.5×5 (LCD front panel)

► To replace the LCD front panel:

- 1 Complete the steps in “[Preparing the notebook](#)” on [page 37](#).
- 2 Remove the LCD panel assembly by performing [steps 2 – 12](#) of the “[Replacing the LCD panel assembly](#)” procedure on [page 76](#).
- 3 Remove the screw covers from the corner of the LCD front panel.



- 4 Remove the LCD front panel screws.



- 5 Carefully pry loose the front panel from the LCD assembly lid. Start on the bottom side, continue to the left and right sides, and finally the top side. Remove the front panel.

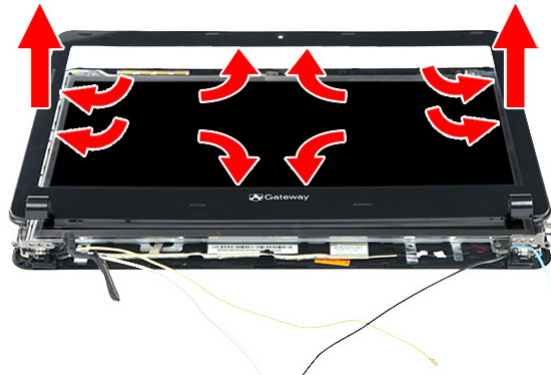

- 6 Place the new front panel on top of the LCD assembly lid. Make sure that the LCD, webcam, microphone, and antenna cables are properly routed on the hinge sides.
- 7 Press the front panel on all sides until it snaps into place. Make sure that there is no gap between the front panel and the LCD assembly lid.
- 8 Secure the front panel with screws removed in [step 4](#).
- 9 Return the LCD front panel screw covers to their places.
- 10 Reinstall the LCD panel assembly by following the [steps 13 – 15](#) of the “[Replacing the LCD panel assembly](#)” procedure on [page 76](#).
- 11 Reinstall the system board by performing [steps 19 and 20](#) of the “[Replacing the system board](#)” procedure on [page 67](#).
- 12 Reinstall the keyboard by performing [steps 21 – 24](#) of the “[Replacing the keyboard](#)” procedure on [page 53](#).
- 13 Reinstall the palm rest module by performing [steps 14 – 17](#) of the “[Replacing the palm rest module](#)” procedure on [page 48](#).
- 14 Reinstall the optical drive by performing [steps 10 and 11](#) of the “[Replacing the optical drive](#)” procedure on [page 46](#).
- 15 Reinstall the hard drive by performing [steps 8 and 9](#) of the “[Replacing the hard drive](#)” procedure on [page 41](#).

- 16 If you have disconnected any wireless antennas, reconnect them now.
- 17 Reinstall the bay cover.
- 18 Reinstall the battery.



Replacing the webcam

Tools you need to complete this task:

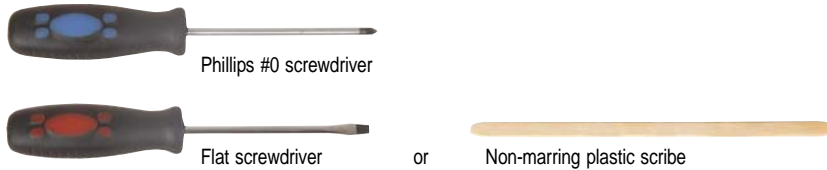

Screws removed during this task:

- 3 black M2.5x6 (bay cover)
- 1 black M2x3 (hard drive)
- 1 black M2.5x6 (optical drive)
- 5 black M2x3 (keyboard frame - top base side) - Indicated by A in [step 8](#) of the “[Replacing the keyboard](#)” procedure on [page 53](#)
- 13 black M2.5x6 (keyboard frame/palm rest module - base side) - indicated by B in [step 8](#) of the “[Replacing the keyboard](#)” procedure on [page 53](#)
- 1 black M2x3 (system board)
- 4 black M2.5x6 (LCD panel hinges)
- 2 black M2.5x5 (LCD front panel)

► To replace the webcam:

- 1 Complete the steps in “[Preparing the notebook](#)” on [page 37](#).
- 2 Remove the LCD panel assembly by performing [steps 2 – 12](#) of the “[Replacing the LCD panel assembly](#)” procedure on [page 76](#).
- 3 Remove the LCD front panel by performing [steps 3 – 5](#) of the “[Replacing the LCD front panel](#)” procedure on [page 79](#).
- 4 Disconnect the webcam cable (1), and then pry the board from the LCD assembly lid (2).

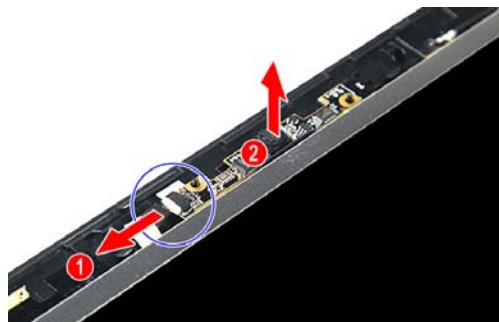

- 5 Place the new webcam on the top side of the LCD assembly lid.
- 6 Reconnect the webcam cable to its board connector.
- 7 Reinstall the LCD front panel by performing [steps 6 – 9](#) of the “[Replacing the LCD front panel](#)” procedure on [page 79](#).
Make sure the webcam lens is aligned with camera peephole on the LCD front panel before you secure the panel in place.
- 8 Reinstall the LCD panel assembly by following the [steps 13 – 15](#) of the “[Replacing the LCD panel assembly](#)” procedure on [page 76](#).
- 9 Reinstall the system board by performing [steps 19 and 20](#) of the “[Replacing the system board](#)” procedure on [page 67](#).
- 10 Reinstall the keyboard by performing [steps 21 – 24](#) of the “[Replacing the keyboard](#)” procedure on [page 53](#).
- 11 Reinstall the palm rest module by performing [steps 14 – 17](#) of the “[Replacing the palm rest module](#)” procedure on [page 48](#).
- 12 Reinstall the optical drive by performing [steps 10 and 11](#) of the “[Replacing the optical drive](#)” procedure on [page 46](#).
- 13 Reinstall the hard drive by performing [steps 8 and 9](#) of the “[Replacing the hard drive](#)” procedure on [page 41](#).
- 14 If you have disconnected any wireless antennas, reconnect them now.
- 15 Reinstall the bay cover.
- 16 Reinstall the battery.



Replacing the LCD panel

Tools you need to complete this task:

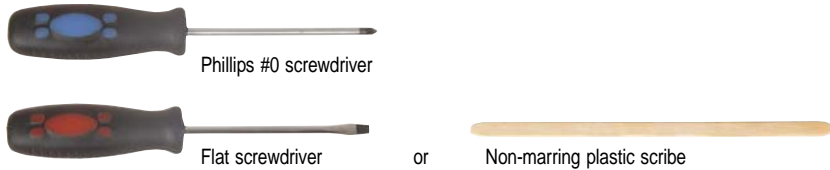

Screws removed during this task:

- 3 black M2.5x6 (bay cover)
- 1 black M2x3 (hard drive)
- 1 black M2.5x6 (optical drive)
- 5 black M2x3 (keyboard frame - top base side) - Indicated by A in [step 8](#) of the “[Replacing the keyboard](#)” procedure on [page 53](#)
- 13 black M2.5x6 (keyboard frame/palm rest module - base side) - indicated by B in [step 8](#) of the “[Replacing the keyboard](#)” procedure on [page 53](#)
- 1 black M2x3 (system board)
- 4 black M2.5x6 (LCD panel hinges)
- 2 black M2.5x5 (LCD front panel)
- 4 chrome M2.5x4 (LCD panel)

► To replace the LCD panel:

- 1 Complete the steps in “[Preparing the notebook](#)” on [page 37](#).
- 2 Remove the LCD panel assembly by performing [steps 2 – 12](#) of the “[Replacing the LCD panel assembly](#)” procedure on [page 76](#).
- 3 Remove the LCD front panel by performing [steps 3 – 5](#) of the “[Replacing the LCD front panel](#)” procedure on [page 79](#).
- 4 Disconnect the webcam cable (1), and then pry the board from the LCD assembly lid (2).

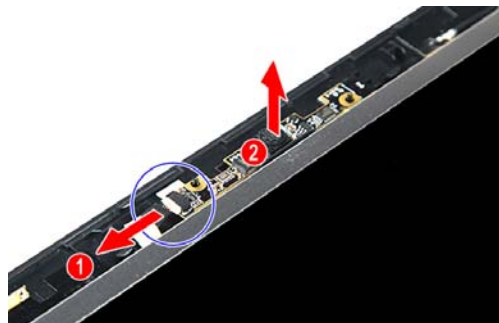

- 5 Remove the LCD panel bracket screws.



- 6 Disconnect the microphone cable.

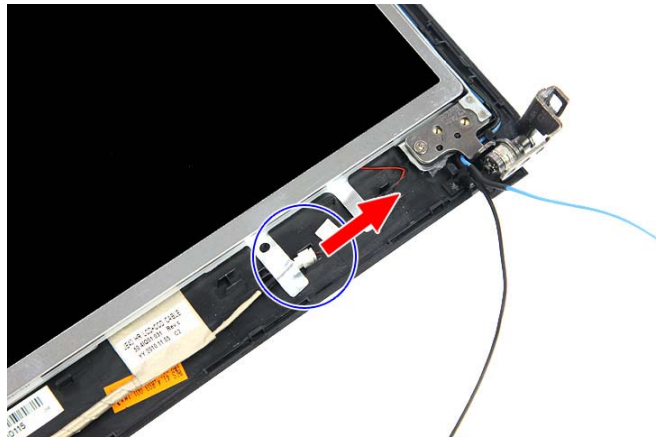

- 7 Remove the LCD panel from the LCD assembly lid.

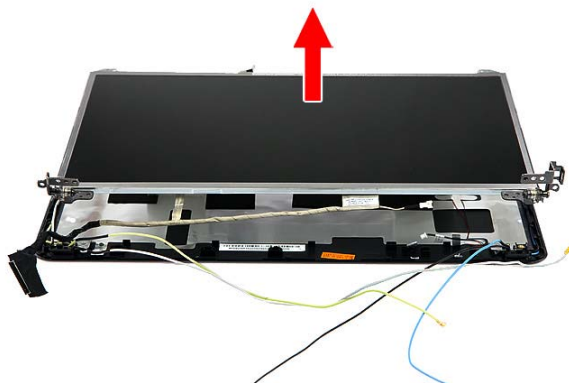

- 8 Turn the LCD on its front to access the LCD-webcam cable.

- 9 Detach the LCD-webcam cable from the LCD's underside.

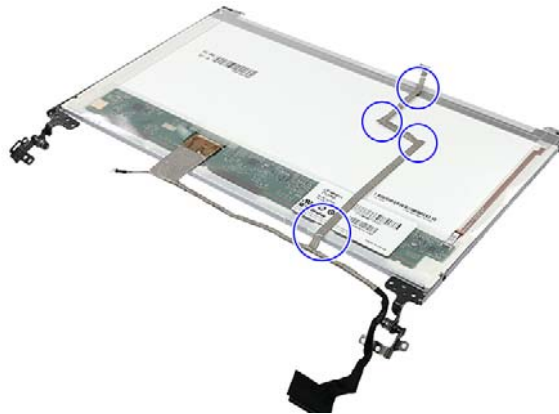

- 10 Disconnect the LCD-webcam cable from the LCD PCB.

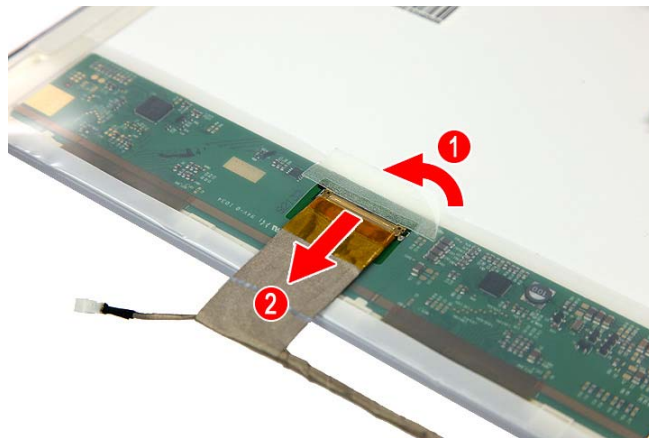

- 11 Attach the LCD panel brackets and the LCD-webcam cable to the new LCD.
- 12 Place the new LCD panel on the LCD assembly lid.
- 13 Reconnect the microphone cable.
- 14 Secure the new LCD panel with the screws removed in [step 5](#).
- 15 Reinstall the LCD front panel by performing [steps 6 – 9](#) of the “[Replacing the LCD front panel](#)” procedure on [page 79](#).
Make sure the webcam lens is aligned with camera peephole on the LCD front panel before you secure the panel in place.
- 16 Reinstall the LCD panel assembly by following the [steps 13 – 15](#) of the “[Replacing the LCD panel assembly](#)” procedure on [page 76](#).
- 17 Reinstall the system board by performing [steps 19 and 20](#) of the “[Replacing the system board](#)” procedure on [page 67](#).
- 18 Reinstall the keyboard by performing [steps 21 – 24](#) of the “[Replacing the keyboard](#)” procedure on [page 53](#).
- 19 Reinstall the palm rest module by performing [steps 14 – 17](#) of the “[Replacing the palm rest module](#)” procedure on [page 48](#).
- 20 Reinstall the optical drive by performing [steps 10 and 11](#) of the “[Replacing the optical drive](#)” procedure on [page 46](#).

- 21 Reinstall the hard drive by performing [steps 8 and 9](#) of the “[Replacing the hard drive](#)” procedure on [page 41](#).
- 22 If you have disconnected any wireless antennas, reconnect them now.
- 23 Reinstall the bay cover.
- 24 Reinstall the battery.







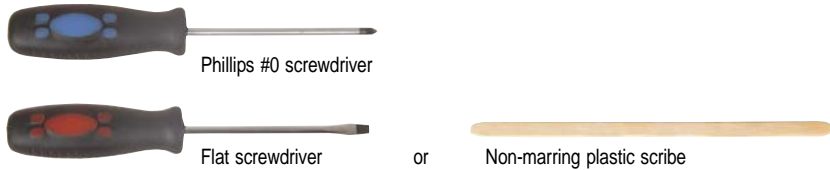































Replacing the LCD panel hinge brackets

Tools you need to complete this task:



Screws removed during this task:

-  3 black M2.5x6 (bay cover)
-  1 black M2x3 (hard drive)
-  1 black M2.5x6 (optical drive)
-      5 black M2x3 (keyboard frame - top base side) - Indicated by A in [step 8](#) of the [“Replacing the keyboard”](#) procedure on [page 53](#)
-               13 black M2.5x6 (keyboard frame/palm rest module - base side) - indicated by B in [step 8](#) of the [“Replacing the keyboard”](#) procedure on [page 53](#)
-  1 black M2x3 (system board)
-     4 black M2.5x6 (LCD panel hinges)
-   2 black M2.5x5 (LCD front panel)
-     4 chrome M2.5x4 (LCD panel)
-     4 chrome M2x3 (LCD panel hinge brackets)

► To replace the LCD:

- 1 Complete the steps in [“Preparing the notebook”](#) on [page 37](#).
- 2 Remove the LCD panel assembly by performing [steps 2 – 12](#) of the [“Replacing the LCD panel assembly”](#) procedure on [page 76](#).
- 3 Remove the LCD front panel by performing [steps 3 – 5](#) of the [“Replacing the LCD front panel”](#) procedure on [page 79](#).
- 4 Remove the LCD panel by performing [steps 4 – 7](#) of the [“Replacing the LCD panel”](#) procedure on [page 84](#).

- 5 Remove the screws securing the LCD panel brackets.



- 6 Attach the new LCD panel brackets to the LCD.
- 7 Reinstall the LCD panel by performing [steps 11 – 14](#) of the “[Replacing the LCD panel](#)” procedure on [page 84](#).
- 8 Reinstall the LCD front panel by performing [steps 6 – 9](#) of the “[Replacing the LCD front panel](#)” procedure on [page 79](#).
Make sure the webcam lens is aligned with camera peephole on the LCD front panel before you secure the panel in place.
- 9 Reinstall the LCD panel assembly by following the [steps 13 – 15](#) of the “[Replacing the LCD panel assembly](#)” procedure on [page 76](#).
- 10 Reinstall the system board by performing [steps 19](#) and [20](#) of the “[Replacing the system board](#)” procedure on [page 67](#).
- 11 Reinstall the keyboard by performing [steps 21 – 24](#) of the “[Replacing the keyboard](#)” procedure on [page 53](#).
- 12 Reinstall the palm rest module by performing [steps 14 – 17](#) of the “[Replacing the palm rest module](#)” procedure on [page 48](#).
- 13 Reinstall the optical drive by performing [steps 10](#) and [11](#) of the “[Replacing the optical drive](#)” procedure on [page 46](#).
- 14 Reinstall the hard drive by performing [steps 8](#) and [9](#) of the “[Replacing the hard drive](#)” procedure on [page 41](#).
- 15 If you have disconnected any wireless antennas, reconnect them now.
- 16 Reinstall the bay cover.
- 17 Reinstall the battery.







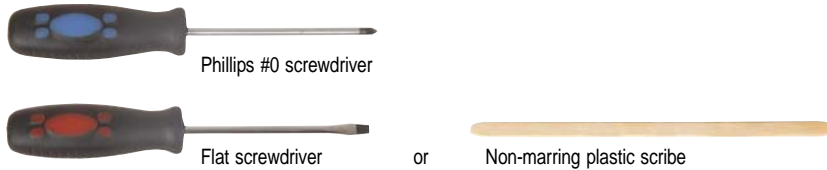



























Replacing the microphone

Tools you need to complete this task:



Screws removed during this task:

-  3 black M2.5x6 (bay cover)
-  1 black M2x3 (hard drive)
-  1 black M2.5x6 (optical drive)
-      5 black M2x3 (keyboard frame - top base side) - Indicated by A in [step 8](#) of the [“Replacing the keyboard”](#) procedure on [page 53](#)
-               13 black M2.5x6 (keyboard frame/palm rest module - base side) - indicated by B in [step 8](#) of the [“Replacing the keyboard”](#) procedure on [page 53](#)
-  1 black M2x3 (system board)
-     4 black M2.5x6 (LCD panel hinges)
-   2 black M2.5x5 (LCD front panel)
-     4 chrome M2.5x4 (LCD panel)

► To replace the microphone:

- 1 Complete the steps in [“Preparing the notebook”](#) on [page 37](#).
- 2 Remove the LCD panel assembly by performing [steps 2 – 12](#) of the [“Replacing the LCD panel assembly”](#) procedure on [page 76](#).
- 3 Remove the LCD front panel by performing [steps 3 – 5](#) of the [“Replacing the LCD front panel”](#) procedure on [page 79](#).
- 4 Remove the LCD panel by performing [steps 4 – 7](#) of the [“Replacing the LCD panel”](#) procedure on [page 84](#).

- 5 Release the microphone cable from the adhesive tabs securing them, and then remove the microphone from the LCD assembly lid.

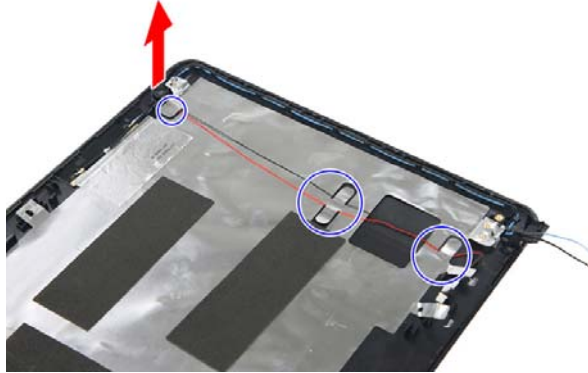

- 6 Place the new microphone on the LCD assembly lid and secure its cable on the adhesive tabs.
- 7 Reinstall the LCD panel by performing [steps 11 – 14](#) of the “[Replacing the LCD panel](#)” procedure on [page 84](#).
- 8 Reinstall the LCD front panel by performing [steps 6 – 9](#) of the “[Replacing the LCD front panel](#)” procedure on [page 79](#).
Make sure the webcam lens is aligned with camera peephole on the LCD front panel before you secure the panel in place.
- 9 Reinstall the LCD panel assembly by following the [steps 13 – 15](#) of the “[Replacing the LCD panel assembly](#)” procedure on [page 76](#).
- 10 Reinstall the system board by performing [steps 19](#) and [20](#) of the “[Replacing the system board](#)” procedure on [page 67](#).
- 11 Reinstall the keyboard by performing [steps 21 – 24](#) of the “[Replacing the keyboard](#)” procedure on [page 53](#).
- 12 Reinstall the palm rest module by performing [steps 14 – 17](#) of the “[Replacing the palm rest module](#)” procedure on [page 48](#).
- 13 Reinstall the optical drive by performing [steps 10](#) and [11](#) of the “[Replacing the optical drive](#)” procedure on [page 46](#).
- 14 Reinstall the hard drive by performing [steps 8](#) and [9](#) of the “[Replacing the hard drive](#)” procedure on [page 41](#).
- 15 If you have disconnected any wireless antennas, reconnect them now.
- 16 Reinstall the bay cover.
- 17 Reinstall the battery.







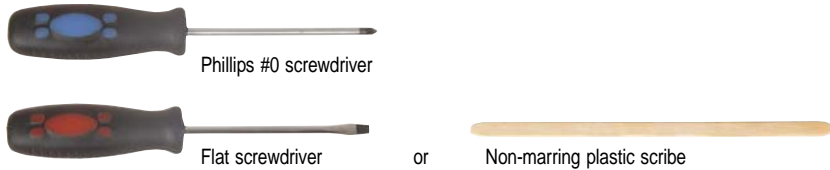



























Replacing the antennas

Tools you need to complete this task:



Screws removed during this task:

-  3 black M2.5x6 (bay cover)
-  1 black M2x3 (hard drive)
-  1 black M2.5x6 (optical drive)
-      5 black M2x3 (keyboard frame - top base side) - Indicated by A in [step 8](#) of the [“Replacing the keyboard”](#) procedure on [page 53](#)
-               13 black M2.5x6 (keyboard frame/palm rest module - base side) - indicated by B in [step 8](#) of the [“Replacing the keyboard”](#) procedure on [page 53](#)
-  1 black M2x3 (system board)
-     4 black M2.5x6 (LCD panel hinges)
-   2 black M2.5x5 (LCD front panel)
-     4 chrome M2.5x4 (LCD panel)

► To replace the antennas:

- 1 Complete the steps in [“Preparing the notebook”](#) on [page 37](#).
- 2 Remove the LCD panel assembly by performing [steps 2 – 12](#) of the [“Replacing the LCD panel assembly”](#) procedure on [page 76](#).
- 3 Remove the LCD front panel by performing [steps 3 – 5](#) of the [“Replacing the LCD front panel”](#) procedure on [page 79](#).
- 4 Remove the LCD panel by performing [steps 4 – 7](#) of the [“Replacing the LCD panel”](#) procedure on [page 84](#).

- 5 Release the antenna cables from the retaining latches securing them, and then carefully pry the cables loose from the LCD assembly lid to remove the antennas.

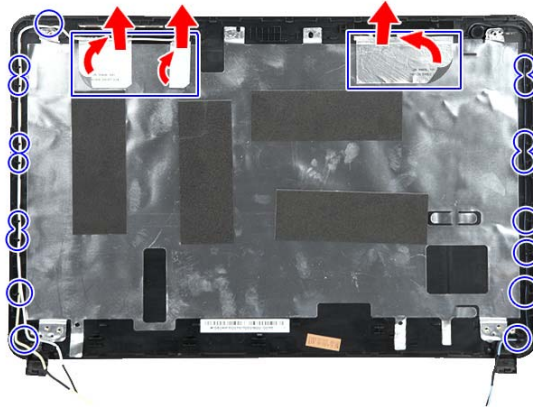

- 6 Secure the new antenna cables on the LCD assembly lid and route their cables underneath the adhesive tabs.
- 7 Reinstall the LCD panel by performing [steps 11 – 14](#) of the “[Replacing the LCD panel](#)” procedure on [page 84](#).
- 8 Reinstall the LCD front panel by performing [steps 6 – 9](#) of the “[Replacing the LCD front panel](#)” procedure on [page 79](#).
Make sure the webcam lens is aligned with camera peephole on the LCD front panel before you secure the panel in place.
- 9 Reinstall the LCD panel assembly by following the [steps 13 – 15](#) of the “[Replacing the LCD panel assembly](#)” procedure on [page 76](#).
- 10 Reinstall the system board by performing [steps 19 and 20](#) of the “[Replacing the system board](#)” procedure on [page 67](#).
- 11 Reinstall the keyboard by performing [steps 21 – 24](#) of the “[Replacing the keyboard](#)” procedure on [page 53](#).
- 12 Reinstall the palm rest module by performing [steps 14 – 17](#) of the “[Replacing the palm rest module](#)” procedure on [page 48](#).
- 13 Reinstall the optical drive by performing [steps 10 and 11](#) of the “[Replacing the optical drive](#)” procedure on [page 46](#).
- 14 Reinstall the hard drive by performing [steps 8 and 9](#) of the “[Replacing the hard drive](#)” procedure on [page 41](#).
- 15 If you have disconnected any wireless antennas, reconnect them now.
- 16 Reinstall the bay cover.
- 17 Reinstall the battery.







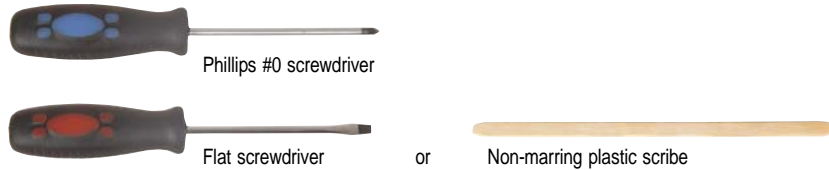



























Replacing the LCD assembly lid

Tools you need to complete this task:



Screws removed during this task:

-  3 black M2.5x6 (bay cover)
-  1 black M2x3 (hard drive)
-  1 black M2.5x6 (optical drive)
-      5 black M2x3 (keyboard frame - top base side) - Indicated by A in [step 8](#) of the “[Replacing the keyboard](#)” procedure on [page 53](#)
-               13 black M2.5x6 (keyboard frame/palm rest module - base side) - indicated by B in [step 8](#) of the “[Replacing the keyboard](#)” procedure on [page 53](#)
-  1 black M2x3 (system board)
-     4 black M2.5x6 (LCD panel hinges)
-   2 black M2.5x5 (LCD front panel)
-     4 chrome M2.5x4 (LCD panel)

► To replace the LCD assembly lid:

- 1 Complete the steps in “[Preparing the notebook](#)” on [page 37](#).
- 2 Remove the LCD panel assembly by performing [steps 2 – 12](#) of the “[Replacing the LCD panel assembly](#)” procedure on [page 76](#).
- 3 Remove the LCD front panel by performing [steps 3 – 5](#) of the “[Replacing the LCD front panel](#)” procedure on [page 79](#).
- 4 Remove the LCD panel by performing [steps 4 – 7](#) of the “[Replacing the LCD panel](#)” procedure on [page 84](#).
- 5 If you are going to use the same webcam, microphone and wireless antennas, remove these items from the old LCD assembly lid and attach them to the new one. Refer to the related replacement procedure on previous pages for instructions.
- 6 Reinstall the LCD panel by performing [steps 11 – 14](#) of the “[Replacing the LCD panel](#)” procedure on [page 84](#).
- 7 Reinstall the LCD front panel by performing [steps 6 – 9](#) of the “[Replacing the LCD front panel](#)” procedure on [page 79](#).
Make sure the webcam lens is aligned with camera peephole on the LCD front panel before you secure the panel in place.
- 8 Reinstall the LCD panel assembly by following the [steps 13 – 15](#) of the “[Replacing the LCD panel assembly](#)” procedure on [page 76](#).

- 9 Reinstall the system board by performing [steps 19](#) and [20](#) of the “[Replacing the system board](#)” procedure on [page 67](#).
- 10 Reinstall the keyboard by performing [steps 21 – 24](#) of the “[Replacing the keyboard](#)” procedure on [page 53](#).
- 11 Reinstall the palm rest module by performing [steps 14 – 17](#) of the “[Replacing the palm rest module](#)” procedure on [page 48](#).
- 12 Reinstall the optical drive by performing [steps 10](#) and [11](#) of the “[Replacing the optical drive](#)” procedure on [page 46](#).
- 13 Reinstall the hard drive by performing [steps 8](#) and [9](#) of the “[Replacing the hard drive](#)” procedure on [page 41](#).
- 14 If you have disconnected any wireless antennas, reconnect them now.
- 15 Reinstall the bay cover.
- 16 Reinstall the battery.



CHAPTER 4

Troubleshooting

- Diagnosing problems
- System test procedures
- Power-On Self-Test (POST) error message
- Index of error messages
- Phoenix BIOS beep codes
- Symptom-to-FRU error messages
- Intermittent problems
- Undetermined problems

Diagnosing problems

Use the following procedure as a guide for diagnosing notebook problems.



Important

The diagnostic tests are intended to test only Acer products. Non-Acer products, prototype cards, or modified options can give false errors and invalid system responses.

- 1 Obtain the failing symptoms in as much detail as possible.
- 2 Verify the symptoms by attempting to re-create the failure by running the diagnostic test or by repeating the same operation.
- 3 Use the following table with the verified symptom to determine which page to go to.

Symptoms (Verified)	Go To
Power failure. (The power indicator does not go on or stay on.)	“Testing the power system” on page 100
POST does not complete. No beep or error codes are indicated.	<ul style="list-style-type: none"> ▪ “Power-On Self-Test (POST) error message” on page 102 ▪ “Undetermined problems” on page 115
POST detects an error and displayed messages on screen.	“Index of error messages” on page 103
Other symptoms (LCD display problems or others).	“Power-On Self-Test (POST) error message” on page 102
Symptoms cannot be re-created (intermittent problems).	<ul style="list-style-type: none"> ▪ Use the customer-reported symptoms and go to “Power-On Self-Test (POST) error message” on page 102 ▪ “Intermittent problems” on page 114 ▪ “Undetermined problems” on page 115

System test procedures

Testing the optical drive

Use the following procedure to isolate a problem in an optical drive controller, driver, or drive.

 **Important**
Make sure that the CD-ROM does not have any label attached to it. The label can cause damage to the drive or can cause the drive to fail.

▶ To test the optical drive:

- 1 Boot from the diagnostics diskette and start the diagnostics program.
- 2 Run the CD-ROM Test and see if the test completes successfully.
- 3 Follow the instructions in the message window.
If an error occurs, reconnect the connector on the system board.
If the error still remains:
- 4 Reconnect the external optical drive to a USB jack.
- 5 Replace the external optical drive.
- 6 Replace the system board.



Testing the keyboard or auxiliary input device

If the internal keyboard does not work or an unexpected character appears, make sure that the flexible cable extending from the keyboard is correctly seated in the connector on the system board. If the keyboard cable is connected correctly, run the Keyboard Test.

 **Important**
Disconnect any external keyboards before testing the built-in keyboard.

If the tests detect a keyboard problem, do the following one at a time.

▶ To correct the problem:

- 1 Reconnect the keyboard cable to the system board.
- 2 Replace the keyboard.
- 3 Replace the system board.



 **Important**
Do not replace a non-defective FRU.

The following auxiliary input devices are supported by this notebook:

- Numeric keypad
- External keyboard

If any of these devices do not work, reconnect the cable connector and repeat the failing operation.

Testing the memory

Memory errors can stop your programs, show error messages on the screen, or hang the system.

▶ To test the memory:

- 1 Boot from the diagnostics diskette and start the diagnostics program.
- 2 Run the Memory Test and see if the test completes successfully.
- 3 Press F2 in the test items.
- 4 Follow the instructions in the message window.



Important

Make sure that each memory card is fully installed into the connector. A loose connection can cause an error.



Testing the power system

▶ To test for a power problem:

- Turn on the notebook using each of the following power sources:
 - Remove the battery pack, connect the power adapter, then make sure that the notebook turns on using AC power.
 - Disconnect the power adapter, install a charged battery pack, then make sure that power is supplied by the battery pack.



If you suspect a power problem, complete the appropriate power supply check:

- [“Check the power adapter” on page 100](#)
- [“Check the battery pack” on page 101](#)

Check the power adapter

Unplug the power adapter cable from the notebook and measure the output voltage at the power adapter cable plug. See the following figure.

Pin 1: +19 to +20.5V
Pin 2: 0V, Ground

- If the voltage is not correct, replace the power adapter.
- If the voltage is within the range, do the following:
 - Replace the system board.
 - If the problem is not corrected, see [“Undetermined problems” on page 115](#).
 - If the power-on indicator does not light up, check the power adapter’s power cord for correct continuity and installation.
 - If the operational charge does not work, see [“Check the battery pack” on page 101](#).



Important

An audible noise from the power adapter does not always indicate a defect.

Check the battery pack

▶ To check the battery pack using software:

- 1 Open Power Management in the Windows Control Panel.
- 2 In Power Meter, make sure that the parameters shown for Current Power Source and Total Battery Power Remaining are correct.
- 3 Repeat the steps 1 and 2, for both battery and adapter. This helps you identify first the problem is on recharging or discharging.



▶ To check the battery pack using hardware:

- 1 Turn off the notebook.
- 2 Remove the battery pack and measure the voltage between battery terminals 1 (+) and 6 (ground).
- 3 If the voltage is still less than 7.5 Vdc after recharging, replace the battery.



 **Important**

To check the battery charge operation, use a discharged battery pack or a battery pack that has less than 50% of the total power remaining when installed in the notebook.

If the battery status indicator does not light up, remove the battery pack and let it return to room temperature. Re-install the battery pack.

If the charge indicator still does not light up, replace the battery pack. If the charge indicator still does not light up, replace the DC/DC charger board.

Testing the touchpad

If the touchpad doesn't work, do the following actions one at a time to correct the problem.

▶ To test the touchpad:

- 1 Reconnect the touchpad cables.
- 2 Replace the touchpad.
- 3 Replace the system board.



 **Important**

Do not replace a non-defective FRU.

After you use the touchpad, the pointer may drift on the screen for a short time. This self-acting pointer movement can occur when a slight, steady pressure is applied to the touchpad pointer. This symptom is not a hardware problem. No service actions are necessary if the pointer movement stops in a short period of time.

Power-On Self-Test (POST) error message

The POST error message index lists the error message and their possible causes. The most likely cause is listed first.



Important

Perform the FRU replacement or actions in the sequence shown in the FRU/Action column. If the FRU replacement does not solve the problem, put the original part back in the notebook. Do not replace a non-defective FRU.

This index can also help you determine the next possible FRU to be replaced when servicing a notebook.

If the symptom is not listed, see [“Undetermined problems” on page 115](#).

The following lists the error messages that the BIOS displays on the screen and the error symptoms classified by function.



Important

Most of the error messages occur during POST. Some of them display information about a hardware device, such as the amount of memory installed. Others may indicate a problem with a device, such as the way it has been configured.



Important

If the system fails after you make changes in the BIOS Setup Utility menus, reset the notebook, enter Setup, and install Setup defaults or correct the error.

Index of error messages

Error codes

Error Codes	Error Messages
006	Equipment Configuration Error Causes: 1. CPU BIOS Update Code Mismatch 2. IDE Primary Channel Master Drive Error (The causes are shown before "Equipment Configuration Error")
010	Memory Error at xxx:xxx:xxxh (R:xxxh, W:xxxh)
070	Real Time Clock Error
071	CMOS Battery Bad
072	CMOS Checksum Error
110	System is disabled. An incorrect password was entered.
<No error code>	Battery is critically low. In this situation BIOS issues four short beeps, then shuts the system down. No message is displayed.
<No error code>	Temperature is critically high. In this situation BIOS shuts the system down. No message is displayed.

Error messages

Error Messages	FRU/Action Sequence
Failure Fixed Disk	<ul style="list-style-type: none"> ▪ Reconnect the hard disk drive connector. ▪ Run "Load Setup Defaults" using the BIOS Setup Utility, then reboot the notebook. ▪ Test or replace the hard disk drive. ▪ Test or replace the system board.
Stuck Key	See "Testing the keyboard or auxiliary input device" on page 99.
Keyboard error	See "Testing the keyboard or auxiliary input device" on page 99.
Keyboard Controller Failed	See "Testing the keyboard or auxiliary input device" on page 99.
Keyboard locked - Unlock key switch	Unlock the external keyboard.
Monitor type does not match CMOS - Run Setup	Run "Load Setup Defaults" using the BIOS Setup Utility, then reboot the notebook.
Shadow RAM Failed at offset: nnnn	<ul style="list-style-type: none"> ▪ Test or replace the BIOS ROM. ▪ Test or replace the system board.
System RAM Failed at offset: nnnn	<ul style="list-style-type: none"> ▪ Test or replace the SO-DIMM. ▪ Test or replace the system board.
Extended RAM Failed at offset: nnnn	<ul style="list-style-type: none"> ▪ Test or replace the SO-DIMM. ▪ Test or replace the system board.
System battery is dead - Replace and run Setup	Test or replace the CMOS battery, run the BIOS Setup Utility to reconfigure system time, then reboot the system.
System CMOS checksum bad - Default configuration used	Test or replace the CMOS battery, run the BIOS Setup Utility to reconfigure system time, then reboot the system.

Error Messages	FRU/Action Sequence
System timer error	<ul style="list-style-type: none"> ▪ Test or replace the CMOS battery, run the BIOS Setup Utility to reconfigure system time, then reboot the system. ▪ Test or replace the system board.
Real time clock error	<ul style="list-style-type: none"> ▪ Test or replace the CMOS battery, run the BIOS Setup Utility to reconfigure system time, then reboot the system. ▪ Test or replace the system board.
Previous boot incomplete - Default configuration used	<ul style="list-style-type: none"> ▪ Run "Load Setup Defaults" using the BIOS Setup Utility, then reboot the notebook. ▪ Test or replace the CMOS battery, run the BIOS Setup Utility to reconfigure system time, then reboot the system. ▪ Test or replace the system board.
Memory size found by POST differed from CMOS	<ul style="list-style-type: none"> ▪ Run "Load Setup Defaults" using the BIOS Setup Utility, then reboot the notebook. ▪ Test or replace the SO-DIMM. ▪ Test or replace the system board.
Diskette drive A error	<ul style="list-style-type: none"> ▪ Make sure that the drive is defined with the proper diskette type in the BIOS Setup Utility.
Incorrect Drive A type - run SETUP	Make sure that the drive is defined with the proper diskette type in the BIOS Setup Utility
System cache error - Cache disabled	Test or replace the system board.
CPU ID:	Test or replace the system board.
DMA Test Failed	<ul style="list-style-type: none"> ▪ Test or replace the SO-DIMM. ▪ Test or replace the system board.
Software NMI Failed	<ul style="list-style-type: none"> ▪ Test or replace the SO-DIMM. ▪ Test or replace the system board.
Fail-Safe Timer NMI Failed	<ul style="list-style-type: none"> ▪ Test or replace the SO-DIMM. ▪ Test or replace the system board.
Device Address Conflict	<ul style="list-style-type: none"> ▪ Run "Load Setup Defaults" using the BIOS Setup Utility, then reboot the notebook. ▪ Test or replace the CMOS battery, run the BIOS Setup Utility to reconfigure system time, then reboot the system. ▪ Test or replace the system board.
Allocation Error for device	<ul style="list-style-type: none"> ▪ Run "Load Setup Defaults" using the BIOS Setup Utility, then reboot the notebook. ▪ Test or replace the CMOS battery, run the BIOS Setup Utility to reconfigure system time, then reboot the system. ▪ Test or replace the system board.
Failing Bits: nnnn	<ul style="list-style-type: none"> ▪ Test or replace the SO-DIMM. ▪ Test or replace the BIOS ROM. ▪ Test or replace the system board.
Fixed Disk n	None
Invalid System Configuration Data	<ul style="list-style-type: none"> ▪ Test or replace the BIOS ROM. ▪ Test or replace the system board.

Error Messages	FRU/Action Sequence
I/O device IRQ conflict	<ul style="list-style-type: none"> ▪ Run "Load Setup Defaults" using the BIOS Setup Utility, then reboot the notebook. ▪ Test or replace the CMOS battery, run the BIOS Setup Utility to reconfigure system time, then reboot the system. ▪ Test or replace the system board.
Operating system not found	<ul style="list-style-type: none"> ▪ Run the BIOS Setup Utility and see if fixed disk and drive A: are properly identified. ▪ Test or replace the diskette drive ▪ Test or replace the hard disk drive ▪ Test or replace the system board

No-beep error messages

No-beep Error Messages	FRU/Action in Sequence
No beep, power-on indicator turns off and LCD is blank.	<ul style="list-style-type: none"> ▪ Test the power source (battery pack and power adapter). See "Testing the power system" on page 100. ▪ Make sure that every connector is connected tightly and correctly. ▪ Reconnect the SO-DIMM. ▪ Test or replace the LED board. ▪ Test or replace the system board.
No beep, power-on indicator turns on and LCD is blank.	<ul style="list-style-type: none"> ▪ Test the power source (battery pack and power adapter). See "Testing the power system" on page 100. ▪ Reconnect the LCD connector ▪ Check the hard disk drive. ▪ Check the LCD inverter ID. ▪ Check the LCD cable. ▪ Test or replace the LCD inverter. ▪ Test or replace the LCD. ▪ Test or replace the system board.
No beep, power-on indicator turns on and LCD is blank. But you can see POST on an external CRT.	<ul style="list-style-type: none"> ▪ Reconnect the LCD connectors. ▪ Check the LCD inverter ID. ▪ Check the LCD cable. ▪ Test or replace the LCD inverter. ▪ Test or replace the LCD. ▪ Test or replace the system board.
No beep, power-on indicator turns on and a blinking cursor shown on LCD during POST.	<ul style="list-style-type: none"> ▪ Make sure that every connector is connected tightly and correctly. ▪ Test or replace the system board.
No beep during POST but system runs correctly.	<ul style="list-style-type: none"> ▪ Test or replace the speaker. ▪ Test or replace the system board.

Phoenix BIOS beep codes

Code	Beeps	POST Routine Description
02h		Verify Real Mode
03h		Disable Non-Maskable Interrupt (NMI)
04h		Get CPU type
06h		Initialize system hardware
08h		Initialize chipset with initial POST values
09h		Set IN POST flag
0Ah		Initialize CPU registers
0Bh		Enable CPU cache
0Ch		Initialize caches to initial POST values
0Eh		Initialize I/O component
0Fh		Initialize the local bus IDE
10h		Initialize Power Management
11h		Load alternate registers with initial POST values
12h		Restore CPU control word during warm boot
13h		Initialize PCI Bus Mastering devices
14h		Initialize keyboard controller
16h	1-2-2-3	BIOS ROM checksum
17h		Initialize cache before memory autosize
18h		8254 timer initialization
1Ah		8237 DMA controller initialization
1Ch		Reset Programmable Interrupt Controller
20h	1-3-1-1	Test DRAM refresh
22h	1-3-1-3	Test 8742 Keyboard Controller
24h		Set ES segment register to 4 GB
26h		Enable A20 line
28h		Autosize DRAM
29h		Initialize POST Memory Manager
2Ah		Clear 215 KB base RAM
2Ch	1-3-4-1	RAM failure on address line xxxx
2Eh	1-3-4-3	RAM failure on data bits xxxx of low byte of memory bus
2Fh		Enable cache before system BIOS shadow

Code	Beeps	POST Routine Description
30h	1-4-1-1	RAM failure on data bits xxxx of high byte of memory bus
32h		Test CPU bus-clock frequency
33h		Initialize Phoenix Dispatch Manager
36h		Warm start shut down
38h		Shadow system BIOS ROM
3Ah		Autosize cache
3Ch		Advanced configuration of chipset registers
3Dh		Load alternate registers with CMOS values
42h		Initialize interrupt vectors
45h		POST device initialization
46h	2-1-2-3	Check ROM copyright notice
48h		Check video configuration against CMOS
49h		Initialize PCI bus and devices
4Ah		Initialize all video adapters in system
4Bh		QuietBoot start (optional)
4Ch		Shadow video BIOS ROM
4Eh		Display BIOS copyright notice
50h		Display CPU type and speed
51h		Initialize EISA board
52h		Test keyboard
54h		Set key click if enabled
58h	2-2-3-1	Test for unexpected interrupts
59h		Initialize POST display service
5Ah		Display prompt "Press F2 to enter SETUP"
5Bh		Disable CPU cache
5Ch		Test RAM between 512 and 640 KB
60h		Test extended memory
62h		Test extended memory address lines
64h		Jump to User Patch1
66h		Configure advanced cache registers
67h		Initialize Multi Processor APIC
68h		Enable external and CPU caches
69h		Setup System Management Mode (SMM) area

CHAPTER 4: Troubleshooting

Code	Beeps	POST Routine Description
6Ah		Display external L2 cache size
6Bh		Load custom defaults (optional)
6Ch		Display shadow-area message
6Eh		Display possible high address for UMB recovery
70h		Display error messages
72h		Check for configuration errors
76h		Check for keyboard errors
7Ch		Set up hardware interrupt vectors
7Eh		Initialize coprocessor if present
80h		Disable onboard Super I/O ports and IRQs
81h		Late POST device initialization
82h		Detect and install external RS232 ports
83h		Configure non-MCD IDE controllers
84h		Detect and install external parallel ports
85h		Initialize PC-compatible PnP ISA devices
86h		Re-initialize onboard I/O ports
87h		Configure Motherboard Configurable Devices (optional)
88h		Initialize BIOS Area
89h		Enable Non-Maskable Interrupts (NMIs)
8Ah		Initialize Extended BIOS Data Area
8Bh		Test and initialize PS/2 mouse
8Ch		Initialize floppy controller
8Fh		Determine number of ATA drives (optional)
90h		Initialize hard-disk controllers
91h		Initialize local-bus hard-disk controllers
92h		Jump to UserPatch2
93h		Build MPTABLE for multi-processor boards
95h		Install CD ROM for boot
96h		Clear huge ES segment register
97h		Fixup Multi Processor table
98h	1-2	Search for option ROMs. One long, two short beeps on checksum failure.
99h		Check for SMART drive (optional)
9Ah		Shadow option ROMs

Code	Beeps	POST Routine Description
9Ch		Set up Power Management
9Dh		Initialize security engine (optional)
9Eh		Enable hardware interrupts
9Fh		Determine number of ATA and SCSI drives
A0h		Set time of day
A2h		Check key lock
A4h		Initialize Typematic rate
A8h		Erase F2 prompt
AAh		Scan for F2 key stroke
ACh		Enter SETUP
A Eh		Clear Boot flag
B0h		Check for errors
B2h		POST done- prepare to boot operating system
B4h	1	One short beep before boot
B5h		Terminate QuietBoot (optional)
B6h		Check password (optional)
B9h		Prepare Boot
BAh		Initialize DMI parameters
BBh		Initialize PnP Option ROMs
BCh		Clear parity checkers
BDh		Display MultiBoot menu
BEh		Clear screen (optional)
BFh		Check virus and backup reminders
C0h		Try to boot with INT 19
C1h		Initialize POST Error Manager (PEM)
C2h		Initialize error logging
C3h		Initialize error display function
C4h		Initialize system error handler
C5h		PnPnd dual CMOS (optional)
C6h		Initialize notebook docking (optional)
C7h		Initialize notebook docking late
C8h		Force check (optional)
C9h		Extended checksum (optional)

CHAPTER 4: Troubleshooting

Code	Beeps	POST Routine Description
D2h		Unknown interrupt
E0h		Initialize the chipset
E1h		Initialize the bridge
E2h		Initialize the CPU
E3h		Initialize the system timer
E4h		Initialize system I/O
E5h		Check force recovery boot
E6h		Checksum BIOS ROM
E7h		Go to BIOS
E8h		Set Huge Segment
E9h		Initialize Multi Processor
EAh		Initialize OEM special code
EBh		Initialize PIC and DMA
ECh		Initialize Memory type
EDh		Initialize Memory size
EEh		Shadow Boot Block
EFh		System memory test
F0h		Initialize interrupt vectors
F1h		Initialize Run Time Clock
F2h		Initialize video
F3h		Initialize System Management Mode
F4h	1	Output one beep before boot
F5h		Boot to Mini DOS
F6h		Clear Huge Segment
F7h		Boot to Full DOS

Symptom-to-FRU error messages

LCD

Symptom / Error	Action in Sequence
<ul style="list-style-type: none"> ▪ The LCD backlight doesn't work. ▪ The LCD is too dark. ▪ The LCD brightness cannot be adjusted. ▪ The LCD contrast cannot be adjusted. 	<ul style="list-style-type: none"> ▪ Run "Load Setup Defaults" using the BIOS Setup Utility, then reboot the notebook. ▪ Reconnect the LCD connectors. ▪ Test or replace the keyboard (if contrast and brightness function key doesn't work). ▪ Check the LCD inverter ID. ▪ Test or replace the LCD cable. ▪ Test or replace the LCD inverter. ▪ Test or replace the LCD. ▪ Test or replace the system board.
<ul style="list-style-type: none"> ▪ The LCD screen is unreadable. ▪ Missing pels in characters. ▪ The screen appears abnormal. ▪ The wrong color is displayed. 	<ul style="list-style-type: none"> ▪ Reconnect the LCD connector. ▪ Check the LCD inverter ID. ▪ Test or replace the LCD cable. ▪ Test or replace the LCD inverter. ▪ Test or replace the LCD. ▪ Test or replace the system board.
<p>The LCD is displaying extra horizontal or vertical lines.</p>	<ul style="list-style-type: none"> ▪ Check the LCD inverter ID. ▪ Test or replace the LCD cable. ▪ Test or replace the LCD inverter. ▪ Test or replace the LCD. ▪ Test or replace the system board.

Power

Symptom / Error	Action in Sequence
<p>The notebook shuts down during operation.</p>	<ul style="list-style-type: none"> ▪ Test the power source (battery pack and power adapter). See "Testing the power system" on page 100. ▪ Test or replace the battery pack. ▪ Test or replace the power adapter. ▪ Test or replace the system board.
<p>The notebook doesn't turn on.</p>	<ul style="list-style-type: none"> ▪ Test the power source (battery pack and power adapter). See "Testing the power system" on page 100. ▪ Test or replace the battery pack. ▪ Test or replace the power adapter. ▪ Test or replace the system board.
<p>The notebook doesn't turn off.</p>	<ul style="list-style-type: none"> ▪ Test the power source (battery pack and power adapter). See "Testing the power system" on page 100. ▪ Press and hold the power button for more than four seconds. ▪ Test or replace the system board.
<p>The battery can't be charged.</p>	<ul style="list-style-type: none"> ▪ Test the battery pack. See "Check the battery pack" on page 101. ▪ Test or replace the battery pack. ▪ Test or replace the system board.

Memory

Symptom / Error	Action in Sequence
Memory count (size) appears different from actual size.	<ul style="list-style-type: none"> ▪ Run “Load Setup Defaults” using the BIOS Setup Utility, then reboot the notebook. ▪ Test or replace the SO-DIMM. ▪ Test or replace the system board.

Sound

Symptom / Error	Action in Sequence
No sound comes from the notebook when running Windows multimedia programs.	<ul style="list-style-type: none"> ▪ Reinstall the audio driver. ▪ Test or replace the speakers. ▪ Test or replace the system board.
The internal speakers make noise or emit no sound.	<ul style="list-style-type: none"> ▪ Test or replace the speakers. ▪ Test or replace the system board.

Power management

Symptom / Error	Action in Sequence
The notebook will not hibernate.	<ul style="list-style-type: none"> ▪ Test or replace the keyboard (if control is from the keyboard). ▪ Test or replace the hard disk drive. ▪ Test or replace the system board.
The system doesn't hibernate and emits four short beeps every minute.	<ul style="list-style-type: none"> ▪ Press Fn+O and see if the notebook enters hibernation mode. ▪ Test or replace the touchpad. ▪ Test or replace the keyboard. ▪ Check the hard disk connection to the system board. ▪ Test or replace the hard disk drive. ▪ Test or replace the system board.
The notebook doesn't enter standby mode after closing the LCD.	<ul style="list-style-type: none"> ▪ Make sure that the magnet is in the magnet holder. For more information, see “Replacing the LCD panel” on page 84. ▪ Test or replace the system board.
The system doesn't resume from hibernation mode.	<ul style="list-style-type: none"> ▪ Check the hard disk connection to the system board. ▪ Test or replace the hard disk drive. ▪ Test or replace the system board.
The system doesn't resume from standby mode after opening the LCD.	<ul style="list-style-type: none"> ▪ Make sure that the magnet is in the magnet holder. For more information, see “Replacing the LCD panel” on page 84. ▪ Test or replace the system board.
The battery fuel gauge in Windows doesn't go higher than 90%.	<ul style="list-style-type: none"> ▪ Remove the battery pack and let it cool for two hours. ▪ Refresh the battery (use only battery power until the notebook turns off, then charge the battery). ▪ Test or replace the battery pack. ▪ Test or replace the system board.
The system hangs intermittently.	<ul style="list-style-type: none"> ▪ Reconnect the hard disk drive and optical drive. ▪ Check the hard disk connection to the system board. ▪ Test or replace the system board.

Devices

Symptom / Error	Action in Sequence
System configuration does not match the installed devices.	<ul style="list-style-type: none"> ▪ Run "Load Setup Defaults" using the BIOS Setup Utility, then reboot the notebook. ▪ Reconnect the hard disk drive and optical drive.
The external display does not work correctly.	<ul style="list-style-type: none"> ▪ Press Fn+F4 repeatedly to switch between LCD, external display, and both displays. ▪ Test or replace the system board.
USB does not work correctly.	<ul style="list-style-type: none"> ▪ Test or replace the USB board. ▪ Test or replace the system board.
Printer problems.	<ul style="list-style-type: none"> ▪ Run the printer self-test. ▪ Reinstall the printer driver. ▪ Test or replace the printer cable. ▪ Test or replace the printer. ▪ Test or replace the system board.

Keyboard and touchpad

Symptom / Error	Action in Sequence
The keyboard (one or more keys) does not work.	<ul style="list-style-type: none"> ▪ Reconnect the keyboard cable. ▪ Test or replace the keyboard. ▪ Test or replace the system board.
The touchpad does not work.	<ul style="list-style-type: none"> ▪ Reconnect the touchpad cable. ▪ Test or replace the touchpad board. ▪ Test or replace the system board.



Important

If you cannot find a symptom or an error in this list and the problem remains, see ["Undetermined problems" on page 115](#).

Intermittent problems

Intermittent system hang problems can be caused by a variety of reasons that have nothing to do with a hardware defect. These reasons include: cosmic radiation, electrostatic discharge, or software errors. FRU replacement should be considered only when a recurring problem exists.

- ▶ To analyze an intermittent problem:
 - 1 Run the advanced diagnostic test for the system board in loop mode at least ten times.
 - If any error is detected, replace the FRU.
 - If no error is detected, do not replace any FRU.
 - 2 Rerun the test to verify that there are no more errors.



Undetermined problems

If the diagnostic test may not identify which adapter or device failed, which installed devices are incorrect, whether a short circuit is suspected, or whether the system is inoperative. Use these procedures to isolate the failing FRU (do not isolate a non-defective FRU).



Important

Verify that all attached devices are supported by the notebook.



Important

Verify that the power supply being used at the time of the failure is operating correctly. (See ["Testing the power system" on page 100.](#))

▶ To isolate a failing FRU:

- 1 Turn off the notebook.
- 2 Visually check FRU parts for damage. If you identify any damage, replace the FRU.
- 3 Remove or disconnect all of the following devices:
 - Non-Acer devices
 - Printer, mouse, and other external devices
 - Battery pack
 - Hard disk drive(s)
 - SO-DIMM
 - Optical drive
- 4 Turn on the notebook.
- 5 Determine if the problem has changed.
 - If the problem does not recur, reconnect the removed devices one at a time until you find the failing FRU.
 - If the problem does recur, replace the following FRUs one at a time:
 - System board
 - LCD assembly



Important

Do not replace a non-defective FRU.

CHAPTER 5

Connector locations

- [System board layout](#)

System board layout

Top view

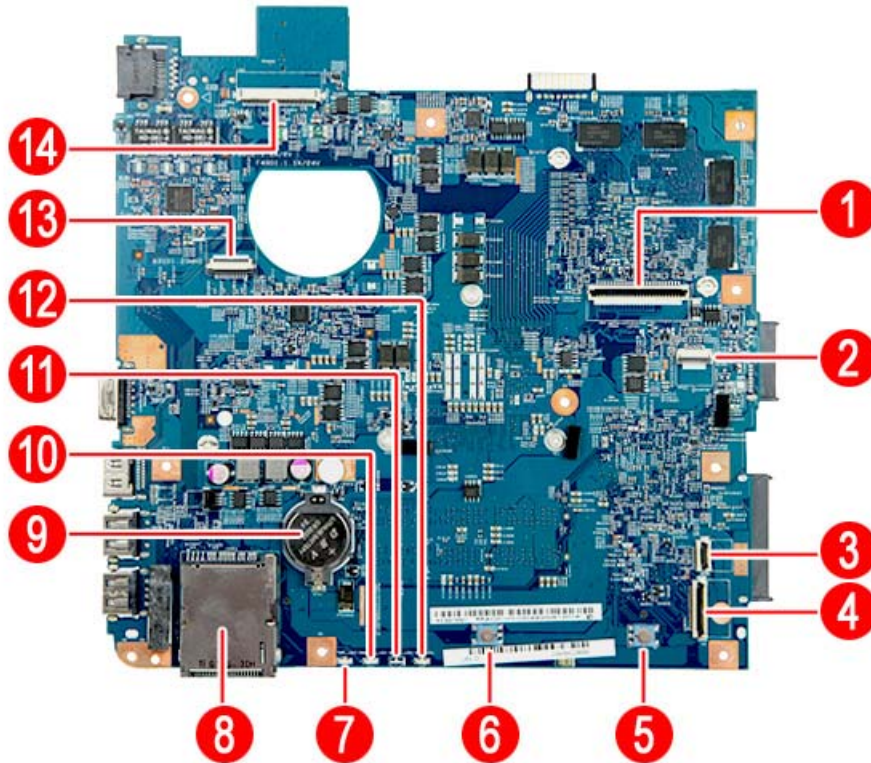

Item	Code	Component	Item	Code	Component
1	KB1	Keyboard cable connector	8	CARD1	Memory card reader
2	TPAD1	Touchpad board cable connector	9	RTC1	Battery
3	USBCN2	USB board cable connector	10	CHARGE_R_LED1	Battery charge indicator
4	USBCN1	USB board cable connector	11	MEDIA_LED1	Hard drive activity indicator
5	SW_R1	Right touchpad button	12	COM_LED1	Bluetooth/Wireless network indicator
6	SW_L1	Left touchpad button	13	PWRCN1	Power button board cable connector
7	PWR_LED1	Power indicator	14	LCD1	LCD cable connector

Bottom view - Discrete model

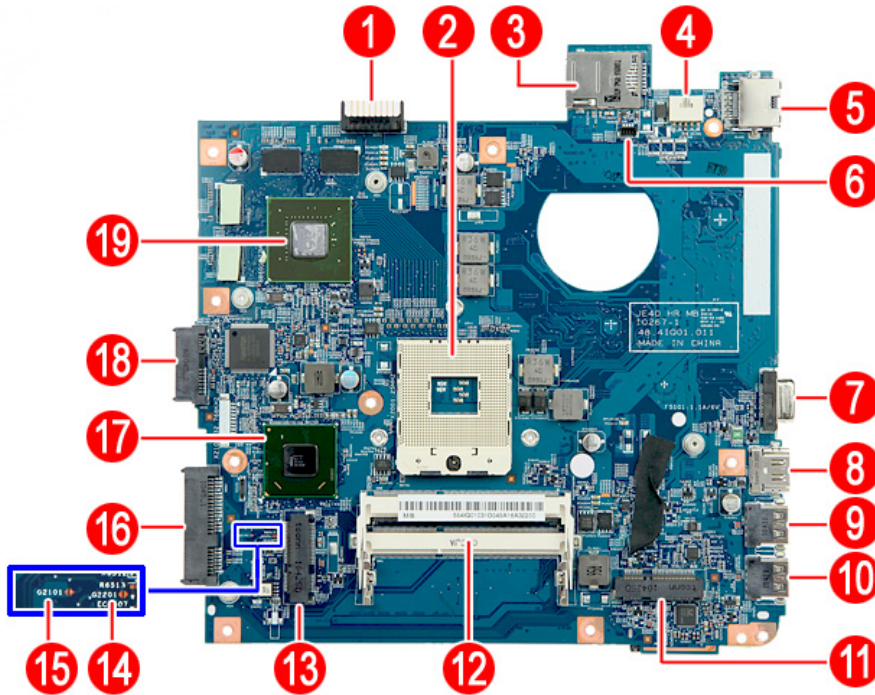

Item	Code	Component	Item	Code	Component
1	BAT1	Battery connector	11	WWAN1	3G module slot
2	CPU1	Processor socket	12	DM1-2	Memory slots 1 and 2
3	SIM1	SIM card slot	13	WLAN1	WLAN module slot
4	DCIN1	DC power cable connector	14	G2201	Clear password hardware gap
5	RJ45	Ethernet jack	15	G2101	Clear CMOS hardware gap
6	FAN1	Fan connector	16	HDD1	HDD connector
7	CRT1	Monitor port	17	PCH1	Mobile Intel HM65 Express Chipset
8	HDMI1	HDMI out port	18	ODD1	SATA optical drive connector
9	USB1	USB port 1	19	VGA1	NVIDIA GeForce graphics controller
10	USB2	USB port 2			

Bottom view - UMA model

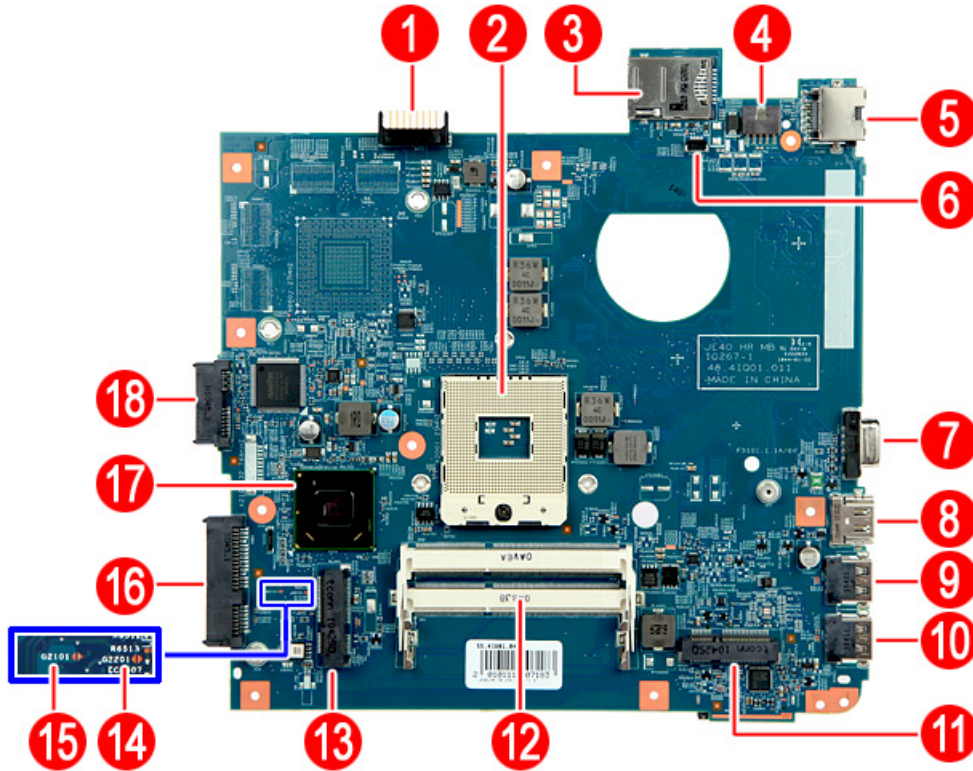

Item	Code	Component	Item	Code	Component
1	BAT1	Battery connector	11	WWAN1	3G module slot
2	CPU1	Processor socket	12	DM1-2	Memory slots 1 and 2
3	SIM1	SIM card slot	13	WLAN1	WLAN module slot
4	DCIN1	DC power cable connector	14	G2201	Clear password hardware gap
5	RJ45	Ethernet jack	15	G2101	Clear CMOS hardware gap
6	FAN1	Fan connector	16	HDD1	HDD connector
7	CRT1	Monitor port	17	PCH1	Mobile Intel HM65 Express Chipset
8	HDMI1	HDMI out port	18	ODD1	SATA optical drive connector
9	USB1	USB port 1			
10	USB2	USB port 2			

CHAPTER 6

FRU (Field-Replaceable Unit) list

- [Introduction](#)
- [Exploded diagram](#)
- [FRU list](#)

Introduction

This chapter gives you the FRU (field-replaceable-unit) listing in global configurations of this model. Refer to this chapter whenever ordering for parts to repair or for RMA (Return Merchandise Authorization).

Please note that **WHEN ORDERING FRU PARTS**, you should check the most up-to-date information available on your regional web or channel. For whatever reasons a part number change is made, it will not be noted on the printed Service Guide. For **ACER AUTHORIZED SERVICE PROVIDERS**, your Acer office may have a **DIFFERENT** part number code from those given in the FRU list of this printed Service Guide. You **MUST** use the local FRU list provided by your regional Acer office to order FRU parts for repair and service of customer machines.



Important

To scrap or to return the defective parts, you should follow the local government ordinance or regulations on how to dispose it properly, or follow the rules set by your regional Acer office on how to return it.

Exploded diagram

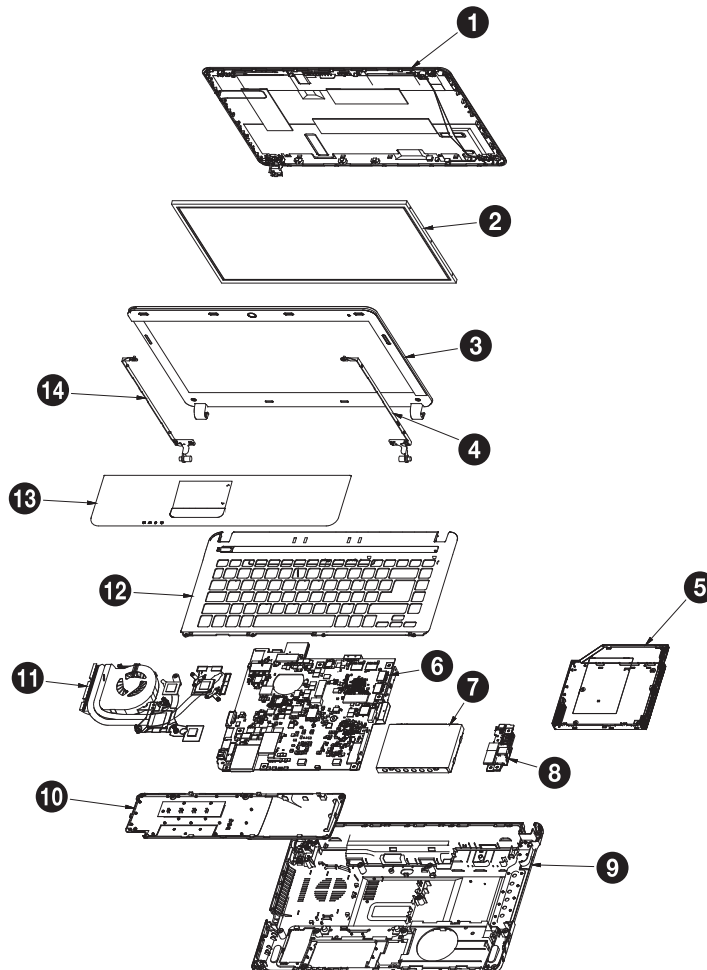

Item	Component
1	LCD assembly lid
2	LCD panel
3	LCD front panel
4	Right LCD panel hinge bracket
5	Optical drive
6	System board
7	Hard drive
8	USB board
9	Base enclosure
10	Bay cover
11	Cooling assembly
12	Keyboard frame
13	Palm rest
14	Right LCD panel hinge bracket

FRU list



Category	Part Name	Description	Part No.
Adapter			
	ADAPTER 65W 19V 3PIN DELTA ADP-65JH DB A LV5 LED LF YEL- LOW	ADP 65W 19V 3P ADP-65JH DB A,	AP.0650A.017
	ADAPTER 65W 19V DELTA ADP-65VH LV5 LOW PROFILE LED LF YELLOW UMA	ADP 65W 19V LV5 ADP-65VH BA LOW PROFILE	AP.06501.026
	ADAPTER 65W 19V 3PIN LITEON PA-1650-22AC LV5 LED LF YELLOW	ADP 65W 19V 3P PA-1650-22AC LV	AP.06501.033
	ADAPTER 65W 19V LITEON PA-1650-69AW LV5 LOW PROFILE LED LF YELLOW UMA	ADP LITEON 65W 19V PA-1650-69AW LV5 L	AP.06503.024
	ADAPTER 65W 19V 3PIN HIPRO HP-A0652R3B 1LF LV5 LED LF YEL- LOW	ADP 65W 19V 3P HP-A0652R3B 1LF	AP.06503.029
	ADAPTER 65W 19V CHICONY- POW CPA09-A065N1 LV5 LOW PROFILE LED LF YELLOW UMA	ADP 65W 19V LV5 CPA09-A065N1 LOW PROFILE	AP.0650A.012
	ADAPTER DELTA 90W 19V 1.7X5.5X11 BLUE ADP-90CD DBH, LV5 LED LF	ADP 90W 19V 3P ADP-90CD DBH LV5 BLUE 1.7	AP.0900A.005
	ADAPTER 90W 19V 3PIN LITEON PA-1900-34AR LV5 LED LF BLUE DIS	ADP 90W 19V 3P PA-1900-34AR LV	AP.09001.031
	ADAPTER 90W 19V 3PIN HIPRO HP-A0904A3 B1LF LV5 LED LF BLUE DIS	ADP 90W 19V 3P HP-A0904A3 B1LF	AP.09003.021





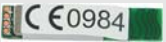

Battery

	BATTERY SANYO AS10D LI-ION 3S2P SANYO 6 CELL 4400MAH MAIN COMMON ID:AS10D31	BTY PACK LI+ SANYO 6C 2.2AH	BT.0060G.001
	BATTERY SONY AS10D LI-ION 3S2P SONY 6 CELL 4400MAH MAIN COMMON ID:AS10D41	BTY PACK LI+ SONY 6C 2.2AH SON	BT.00603.111
	BATTERY PANA-SONIC AS10D LI-ION 3S2P PANASONIC 6 CELL 4400MAH MAIN COMMON ID:AS10D51	BTY PACK LI+ PANA 6C 2.2AH PAN	BT.00604.049
	BATTERY SAM-SUNG AS10D LI-ION 3S2P SAM-SUNG 6 CELL 4400MAH MAIN COMMON ID:AS10D61	BTY PACK LI+ SDI 6C 2.2AH SDI	BT.00605.062
	BATTERY SIMPLO AS10D LI-ION 3S2P PANASONIC 6 CELL 4400MAH MAIN COMMON ID:AS10D71	BTY PACK LI+ PANA 6C 2.2AH SMP	BT.00606.008
	BATTERY SIMPLO AS10D LI-ION 3S2P LGC 6 CELL 4400MAH MAIN COMMON ID:AS10D73	BTY PACK LI+ LG 6C 2.2AH SMP	BT.00607.125
	BATTERY SIMPLO AS10D LI-ION 3S2P SAMSUNG 6 CELL 4400MAH MAIN COMMON ID:AS10D	BTY PACK LI+ SDI 6C 2.2AH SMP	BT.00607.126
	BATTERY LGC AS10D LI-ION 3S2P LGC 6 CELL 4400MAH MAIN COMMON ID:AS10D81	BTY PACK LI+ LG 6C 2.2AH LG	BT.00607.127

Boards

CHAPTER 6: FRU (Field-Replaceable Unit) list

Power button board	POWER BUTTON BOARD	SJV40_HR POWER BD 10759-1 D	55.WVH01.001
			
USB board	USB 2.0 BOARD	JE40_HR USB2.0 BD 10768-1 D	TBD
	USB 3.0 BOARD	JE40_HR USB3.0 BD 10753-1 D	55.RC901.002
Wireless card	WIRELESS LAN BOARD LITEON REALTEK 8192SE BGN WN6603LH 2X2 BGN	WLAN 802.11N 2.4G 2X2 REALTEK RTL8192SE	NI.23600.065
	WIRELESS LAN BOARD FOX-CONN 802.11BGN BCM 43225 2X2 BGN (HM) T77H103.00	WLAN 802.11BGN BCM 43225 BGN 2X2(HM)	NI.23600.066
	WIRELESS LAN BOARD FOX-CONN Atheros HB97 2X2 BGN (HM) T77H167.07	WLAN 802.11BGN 2X2 Atheros HB97 (HM)	54.03346.481
	WIRELESS LAN BOARD LITEON Atheros HB97 2X2 BGN HM WN6603AH	WLAN 802.11BGN Atheros HB97 2X2 BGN (HM)	54.03346.411
	WIRELESS LAN BOARD 802.11BG FOXCONN T77H121.01 Atheros AR9285(HB95)	WLAN 802.11BG Atheros AR9285(HB95) FOR	NI.23600.077
Bluetooth module	BLUETOOTH BOARD FOX-CONN BCM2070 V2.1 T77H114.01 FOR BCM2070 BLUETOOTH CABLE 6PIN CONNECTOR	BT MODULE BCM2070 V2.1 FW 2.2.3.	BH.21100.007
	BLUETOOTH BOARD FOX-CONN BCM2070 V3.0 T77H114.01 FOR BCM2070 BLUETOOTH CABLE 6PIN CONNECTOR	BT MODULE BCM2070 V3.0 FW 2.2.3.	BH.21100.010









Touchpad board 	TOUCHPAD BOARD SYNAPTIC TM-01465-001	TOUCHPAD SYNAPTIC TM-01465-001	56.PUD01.001
Cables			
USB board cable 	USB BOARD CABLE	C.A. USB BD FFC ,TR	50.4IT02.021
	USB BOARD CABLE	C.A. USB BD FFC ,JH	50.4IT02.001
	USB BOARD CABLE	C.A. USB BD FFC ,HB	50.4IT02.011
USB board FPC cable 	USB BOARD CABLE SUPPORT 3.0	C.A. FPC FOR USB 3.0,CMI	50.RC901.003
Touchpad board cable 	TOUCHPAD BOARD CABLE	C.A. UCASE_TP_FCC_SJV40_TR	50.4IR02.011
	TOUCHPAD BOARD CABLE	C.A. UCASE_TP_BUTTON_FCC_SJV40_JH	50.4IR02.001
DC-in cable 	DC-IN CABLE 65W	C.A. DC-IN,65W,MEC	50.4IT06.031
	DC-IN CABLE 65W	C.A. DC-IN,65W,HL	50.4IT06.001
	DC-IN CABLE 65W	C.A.DC-IN,65W,HT	50.4IT06.011
	DC-IN CABLE 65W	C.A. DC-IN,65W,CMI	50.4IT06.021
	DC-IN CABLE 90W	C.A. DC-IN,WEC	50.4IT01.031
	DC-IN CABLE 90W	C.A. DC-IN,90W,HL	50.4IT01.001
	DC-IN CABLE 90W	C.A. DC-IN,90W,HT	50.4IT01.011
	DC-IN CABLE 90W	C.A. DC-IN,90W,CMI	50.4IT01.021
Bluetooth board cable 	BLUETOOTH BOARD CABLE 3.0 6PIN	C.A. HM40HR BT CABLE MEC	50.4IT05.031
	BLUETOOTH BOARD CABLE 3.0 6PIN	C.A. HM40HR BT CABLE HL	50.4IT05.001
	BLUETOOTH BOARD CABLE 3.0 6PIN	C.A. HM40HR BT CABLE HT	50.4IT05.011
	BLUETOOTH BOARD CABLE 3.0 6PIN	C.A. HM40HR BT CABLE YY	50.4IT05.021



CHAPTER 6: FRU (Field-Replaceable Unit) list

<p>Power cord</p> 	POWER CORD 10A 250V SWISS	CODE SWISS 2.5A 250V 3P BK	27.01518.691
	POWER CORD 10A 250V 3PIN SWISS BK	CODE 10A 250V 3P SWISS BK	27.01518.581
	POWER CORD 10A 250V ARGEN- TINE	CORD ARGENTINE,10A 250V3G,1.8M	27.01518.0U1
	POWER CORD 10A 125V US	CODE US 7A 125V BK	27.01518.641
	POWER CORD 10A 125V 3PIN US BK	CODE 10A 125V 3P US BK	27.01518.521
	POWER CORD 7A 250V 2PIN KOREAN	CORD 7A250V 2P 1830 KOREAN	27.01518.531
	POWER CORD 3A 250V 3PIN UK	CODE UK 2.5A 250V 3P BK	27.03118.001
	POWER CORD 5A 250V 3PIN UK BK	CODE 5A 250V 3P UK BK	27.01518.541
	POWER CORD 7A 125V 2PIN JAPAN	CODE JAPAN 7A 125V 2P BK	27.01518.551
	POWER CORD 10A 3PIN BK DEN- MARK	CODE DENMARK 2.5A 250V 3P BK	27.01518.671
	POWER CORD 10A 250V 3PIN DENMARK BK	CODE 10A 250V 3P DENMARK BK	27.01518.561
	POWER CORD 10A 250V 3PIN BK SOUTH AFRICA	CODE SOUTH AFRICA 16A 250V BK	27.01518.681
	POWER CORD 16A 250V SOUTH AFRICA BK	CODE 16A 250V SOUTH AFRICA BK	27.01518.571
	POWER CORD 10A 250V 3PIN CHINA	CORD CHINA 10A 250V 3P	27.01518.701
	POWER CORD 10A 250V 3PIN CHINA BK	CORD 10A 250V 3P CHINA BK	27.01518.591
	POWER CORD 250V 3PIN EUR BK	CORD EUR 250V 3P BK	27.01518.731
	POWER CORD 16A 250V 3PIN EUR BK	CORD 16A 250V 3P EUR BK	27.01518.601
POWER CORD 10A 250V 3PIN ITALY	CORD ITALY 10A 250V 3P BK	27.01518.711	

	POWER CORD 10A 250V 3PIN ITALY BK	CORD 10A 250V 3P ITALY BK	27.01518.611
	POWER CORD 2.5A 250V AUS- TRALIA	CORD 2.5A 250V AUSTRALIA BK	27.01518.621
	POWER CORD 2.5A 250V SOUTH AFRICA BK (INDIA)	CORD 2.5A 250V SOUTH AFRICA BK	27.01518.721
	POWER CORD 10A 250V SOUTH AFRICA BK (INDIA)	CORD 6A 250V SOUTH AFRICA BK	27.01518.631
	POWER CORD 7A 125V 2PIN JAPAN BK	CODE 7A 125V 2P JAPAN BK	27.01518.661
	POWER CORD 250V 10A 3PIN ISRAEL	CORD 250V 10~16A 3P ISRAEL	27.01518.761
	POWER CORD 2.5A 125V USA	CORD USA/W CNS 2.5A 125V 8121-	27.01518.A11
	POWER CORD 2.5A 125V 1.8M BLACK TAIWAN- ESE	POWER CORD TAIWANESE BLACK,1.8	27.01518.781
	POWER CORD 10A 250V 1.8M BRAZIL BLK	POWER CORD BRAZIL,BLK,1.8M	27.01518.A41
	POWER CORD ACA / ACNZ	POWER CODE ACA / ACNZ ANNIE	27.03218.051
	POWER CORD 7.5A 250V 3P AUS- TRALIA BK	CODE 7.5A 250V 3P AUSTRALIA BK	27.03218.021
	POWER CORD 7A 125V 2PIN JAPAN	CODE 7A 125V JAPAN 2PIN BK	27.03518.161
	POWER CORD 10A 250V 3PIN 1.83M BRAZIL BLACK	CORD 1.83M BRAZIL BLK	27.01518.H81
Power button board cable	POWER BUTTON BOARD CABLE	C.A. UCASE_POWER_FCC_SJV40	50.4IR04.001
	POWER BUTTON BOARD CABLE	SJV40_POWER_PCB_FFC_SECOND	50.4IR01.001

CHAPTER 6: FRU (Field-Replaceable Unit) list

	LED LCD/CCD CABLE	C.A. LCD CABLE JE40 HR	50.4IQ01.031
	LED LCD/CCD CABLE	C.A. LCD CABLE_HL JE40 HR	50.4IQ01.001
	LED LCD/CCD CABLE	C.A. LCD CABLE_HC JE40 HR	50.4IQ01.011
	LED LCD/CCD CABLE	C.A. LCD CABLE_YY JE40 HR	50.4IQ01.021
Case/Cover/Bracket Assembly			
	SD DUMMY CARD	DUMMY CARD SJV40	42.WVH01.002
	LOWER CASE	60 L-CAS ASSY SJV40HR NON 3G	60.WVH01.001
	UNITLOAD COVER	ASSY_60_BIG_DOOR_SJV40	42.WVH01.001
	KEYBOARD FRAME W/ SPEAKER	ASSY 60 UCASE SJV40	60.WVH01.002
	PALMREST BLACK	60_SJV40HR_PALMREST_ASSY_LRON_ GRAY	60.WVH01.003
	KEYBOARD SUPPORT W/ POWER BUTTON BOARD CABLE	ASSY _KB_BAT_SJV40	60.WVH01.004
	DVD-RW SUPER-MULT BEZEL	ASSY SJV40 60 ODD BEZEL	42.WVH01.003
	BLUE-RAY COMBO BEZEL	ASSY_60_ODD_SJV40_BLUE_RAY	42.WVH01.004

ODD bracket 	ODD BRACKET	BRKT_ODD_BKT_SJV40	33.4IR03.021
	ODD BRACKET	BRKT ODD BKT MACKING	33.4IR03.001
	ODD BRACKET	BRKT ODD BKT HON WIN	33.4IR03.011
HDD bracket 	HDD BRACKET	ASSY 60 HDD BKT JE40 HR	60.4IQ19.021
	HDD BRACKET	ASSY 60 HDD BKT JE40 HR MACKING	60.4IQ19.001
	HDD BRACKET	ASSY 60 HDD BKT JE40 HR HON WIN	60.4IQ19.011
LCD panel right bracket 	LCD HINGE RIGHT	HINGE LCD R SJV40	34.4IR06.021
	LCD HINGE RIGHT	HINGE SJV40 R JL	34.4IR06.001
	LCD HINGE RIGHT	HINGE SJV40 R XH	34.4IR06.011
LCD panel left bracket 	LCD HINGE LEFT	HINGE LCD L SJV40	34.4IR07.021
	LCD HINGE LEFT	HINGE SJV40 L JL	34.4IR07.001
	LCD HINGE LEFT	HINGE SJV40 L XH	34.4IR07.011
LCD front panel 	LCD BEZEL 14" W/CAMERA HOLE	60 ASSY LCD BEZEL SJV40	60.WVH01.005
LCD assembly lid 	LED LCD COVER 14" IMR BLACK W/ANTENNA*2 & MICROPHONE	ASSY LCD PANEL NON 3G SJV40	60.4IR12.021
	LED LCD COVER 14" IMR BLACK W/ANTENNA*2 & MICROPHONE	60 PANEL NON 3G SJV40 PB BLACK SIPIX	60.4IR12.001
Speaker			
	SPEAKER	SPEAKER YG JE40 HR	23.40908.001
	SPEAKER	SPEAKER FG JE40 HR	23.40909.001
ODD drive			
	BLU-RAY COMBO MODULE 4X SATA	ODD NBDCB4XS FOR SJV40_HRP	6M.WVH01.002
	DVD-RW SUPER MULT 8X MODULE	ODD NSM8XS FOR SJV40_HRP	6M.WVH01.001

CHAPTER 6: FRU (Field-Replaceable Unit) list

<p>ODD SONY BD COMBO 12.7MM TRAY DL 4X BC-5540H LF+HF W/O BEZEL SATA (HF + WINDOWS 7)</p>	<p>BD COMBO 12.7 TL HF SONY BC-5540H</p>	<p>KO.0040E.005</p>
<p>ODD TOSHIBA SUPER-MULTI DRIVE 12.7MM TRAY DL 8X TS-L633F LF W/O BEZEL SATA (HF + WINDOWS 7)</p>	<p>ODD DVDRW 12.7 TL HF TSST TS-L633F</p>	<p>KU.0080F.014</p>
<p>ODD PIONEER SUPER-MULTI DRIVE 12.7MM TRAY DL 8X DVR-TD10RS LF W/O BEZEL 1.00 SATA</p>	<p>ODD DVDRW 12.7 TL HF PIONEER DVR-TD10RS</p>	<p>KU.00801.040</p>
<p>ODD PANASONIC SUPER-MULTI DRIVE 12.7MM TRAY DL 8X UJ890A LF W/O BEZEL SATA HF+WINDOWS 7</p>	<p>ODD SM 12.7 HF+W7 PCC UJ890A</p>	<p>KU.00805.049</p>
<p>ODD PANASONIC SUPER-MULTI DRIVE 12.7MM TRAY DL 8X UJ8A0 LF W/O BEZEL SATA (HF + WINDOWS 7) FOXCONN YEN-TAI FACOTRY</p>	<p>ODD SM 12.7 PANASONIC UJ8A0 W/O BZL WIN7</p>	<p>KU.00807.070</p>
<p>ODD HLDS SUPER-MULTI DRIVE 12.7MM TRAY DL 8X GT32N (R5-2) LF W/O BEZEL SATA WITH RENESAS SOLUTION + PCC LD (HF + WINDOWS 7)</p>	<p>ODD SM 12.7 HF+W7 HLDS GT32N</p>	<p>KU.00807.075</p>
<p>ODD HLDS SUPER-MULTI DRIVE 12.7MM TRAY DL 8X GT34N LF W/O BEZEL SATA ZERO POWER SUPPORTED, PCC LD (HF + WINDOWS 7)</p>	<p>ODD DVDRW 12.7 TL HF+W7 HLDS GT34N</p>	<p>KU.0080D.055</p>

	ODD PLDS SUPER-MULTI DRIVE 12.7MM TRAY PLDS DS-8A5SH LF W/O BEZEL SATA FOR HF+WINDOWS7	ODD SM SATA 12.7 TL PLDS DS-8A5SH	KU.0080D.057
--	----------------------------------------------------------------------------------------	-----------------------------------	--------------

CPU/Processor

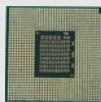
	CPU INTEL CORE I3 I3-2310M PGA 2.1G 35W 2/4	IC CPU SANDY BRIDGE I3-2310M 2.1G 35W PG	KC.23101.DM P
	CPU INTEL CORE I5 I5-2410M PGA 2.3G 35W 2/4	IC CPU SANDY BRIDGE I5-2410M 2.3G 35W PG	KC.24101.DM P
	CPU INTEL CORE I5 I5-2520M PGA 2.5G 35W 2/4	IC CPU SANDY BRIDGE I5-2520M 2.5G 35W PG	KC.25201.DM P
	CPU INTEL CORE I5 I5-2540M PGA 2.6G 35W 2/4	IC CPU SANDY BRIDGE I5-2540M 2.6G 35W PG	KC.25401.DM P
	CPU INTEL CORE I7 I7-2620M PGA 2.7G 35W 2/4	IC CPU SANDY BRIDGE I7-2620M 2.7G 35W PG	KC.26201.DM P
	CPU INTEL CORE I7 I7-2630QM PGA 2.0G 45W 4/8	IC CPU SANDY BRIDGE I7-2630QM 2.0G 45W P	KC.26301.QM P
	CPU INTEL CORE I7 I7-2720QM PGA 2.2G 45W 4/8	IC CPU SANDY BRIDGE I7-2720QM 2.2G 45W P	KC.27201.QM P
	CPU INTEL CORE I7 I7-2820QM PGA 2.3G 45W 4/8	IC CPU SANDY BRIDGE I7-2820QM 2.3G 45W P	KC.28201.QM P

HDD/Hard disk drive

	HDD MODULE 320G 5400RPM 2.5" SATA	HDD 320GB5.4KS FOR SJV40_HRP	
	HDD 320GB 5400RPM 2.5" SATA TOSHIBA MK3265GSX 8MB 68P LF F/W:GJ001J	HDD 320GB TOSHIBA MK3265GSX	KH.32007.008
	HDD 320GB 5400RPM 2.5" SATA HGST HTS545032B9A300 PANTHER B LF F/W:C60F DISK IMBALANCE CRITERIA = 0.014G-CM	HDD 320GB HGST HTS545032B9A300	KH.32004.004

CHAPTER 6: FRU (Field-Replaceable Unit) list

HDD MODULE 320GB5.4KS_4K 5400RPM 2.5" SATA	HDD 320GB5.4KS_4K FOR SJV40_HRP	
HDD WD 2.5" 5400RPM 320GB WD3200BPVT-22Z EST0, ML320S, 4K DRIVE SATA 8MB LF F/W: 01.01A01	HDD 320GB WD WD3200BPVT-22ZEST0 AF 5.4K	KH.32008.022
HDD MODULE 320G 5400RPM 7.0MM 2.5" SATA	HDD N320GB5.4KS7.0 FOR SJV40_HRP	
HDD HGST 2.5" 5400RPM 320GB HTS543232A7A38 4,0J11523, EAGLE B7, 320G/P SATA LF+HF F/W:A60W	HDD 320GB HGST HTS543232A7A384 7mmH 5.4K	KH.32007.013
HDD MODULE 500G 5400RPM 2.5" SATA	HDD 500GB5.4KS FOR SJV40_HRP	
HDD SEAGATE 2.5" 5400RPM 500GB ST9500325AS,9H H134-189, WYATT WITH NEW PCB SATA 8MB LF F/W:0001SDM1	HDD 500GB SEAGATE ST9500325AS 5400RPM	KH.50008.021
HDD 2.5" 5400RPM 500GB TOSHIBA MK5065GSX LIBRA SATA LF F/WGJ001J	HDD 500GB TOSHIBA MK5065GSX	KH.50001.017
HDD HGST 2.5" 5400RPM 500GB HTS545050B9A30 0 PANTHER B SATA LF F/W:C60F DISK IMBALANCE CRITERIA = 0.014G-CM	HDD 500GB HGST HTS545050B9A300	KH.50004.002
HDD WD 2.5" 5400RPM 500GB WD5000BPVT-22H XZT1,ML375_AF, 4K DRIVE SATA 8MB LF+HF F/W:01.01A01	HDD 500GB WD WD5000BPVT-22HXZT1 5.4K AF	KH.50007.010
HDD MODULE 640G 5400RPM 2.5" SATA	HDD 640GB5.4KS FOR SJV40_HRP	

	HDD 640GB 5400RPM 2.5" SATA MK6465GSX LF CAPRICORN BS F/W:GJ001J	HDD 640GB TOSHIBA MK6465GSX	KH.64008.005
	HDD WD 2.5" 5400RPM 640GB WD6400BPVT-22H XZT1, ML375M SATA 8MB LF F/W: 01.01A01	HDD 640GB WD WD6400BPVT-22HXZT1 5.4K AF	KH.64004.001
	HDD MODULE 750G 5400RPM 2.5" SATA	HDD 750GB5.4KS FOR SJV40_HRP	
	HDD SEAGATE 2.5" 5400RPM 750GB ST9750423AS,9Z W14G-188, DESARU5, 375G/P. SATA 8MB LF+HF F/W:0001SDM1	HDD 750GB SEAGATE ST9750423AS 5400RPM	KH.75008.009
	HDD TOSHIBA 2.5" 5400RPM 750GB MK7559GSX, 375G/P, CAPRI- CORN BS, 4K DRIVE SATA 8MB LF+HF F/W:GNDD3J	HDD 750GB TOSHIBA MK7559GSX 5.4K 4Ksecto	KH.75001.011
	HDD HGST 2.5" 5400RPM 750GB HTS547575A9E38 4, 0J15083, JET B, 375G/P SATA 8MB LF F/W:DA3872	HDD 750GB HGST HTS547575A9E384 5400RPM	KH.75004.001
	HDD WD 2.5" 5400RPM 750GB WD7500BPVT-22H XZT1, ML375M, 4K DRIVE SATA 8MB LF F/W:01.01A01	HDD 750GB WD WD7500BPVT-22HXZT1 4K 5.4KR	KH.75007.004
Heatsink/Cooling assembly			
Cooling assembly UMA model	CPU HEATSINK W/FAN FOR UMA	ASSY THM UMA 35W SUNON JE40HR	60.RC801.001
			

Cooling assembly
Discrete model

CPU HEATSINK
W/FAN FOR DIS

ASSY THM DIS 45W SUNON JE40HR

60.RC901.003



Keyboard



KEYBOARD
GATEWAY
GF4T_G11B GF4T
INTERNAL 14
STANDARD 86KS
BLACK ARABIC
TEXTURE

KB MP-10K23A0-442 ARABIC GF4T

90.4IR07.S0A

KEYBOARD
GATEWAY
GF4T_G11B GF4T
INTERNAL 14
STANDARD 86KS
BLACK ARABIC
TEXTURE

KB V121630AS1 AR ARABIC GF4T

90.4IR07.C0A

KEYBOARD
GATEWAY
GF4T_G11B GF4T
INTERNAL 14
STANDARD 87KS
BLACK BELGIUM
TEXTURE

KB MP-10K26B0-442 BELGIUM GF4T

90.4IR07.S1A

KEYBOARD
GATEWAY
GF4T_G11B GF4T
INTERNAL 14
STANDARD 87KS
BLACK BELGIUM
TEXTURE

KB V121630AK1 BE BELGIUM GF4T

90.4IR07.C1A

KEYBOARD
GATEWAY
GF4T_G11B GF4T
INTERNAL 14
STANDARD 87KS
BLACK BRAZILIAN
PORTUGUESE
TEXTURE

KB MP-10K26PA-442 BRAZILIAN GF4T

90.4IR07.S1B

KEYBOARD
GATEWAY
GF4T_G11B GF4T
INTERNAL 14
STANDARD 87KS
BLACK BRAZILIAN
PORTUGUESE
TEXTURE

KB V121630AK1 BR BRAZIL/PORTU-
GUESE GF4T

90.4IR07.C1B

KEYBOARD GATEWAY GF4T_G11B GF4T INTERNAL 14 STANDARD 87KS BLACK CZ/SK TEXTURE	KB MP-10K26CS-442 CZ/SK GF4T	90.4IR07.S13
-------------------------------------------------------------------------------------------------	------------------------------	--------------

KEYBOARD GATEWAY GF4T_G11B GF4T INTERNAL 14 STANDARD 87KS BLACK CZ/SK TEXTURE	KB V121630AK1 CS CZECH/SLOVAK GF4T	90.4IR07.C13
-------------------------------------------------------------------------------------------------	---------------------------------------	--------------

KEYBOARD GATEWAY GF4T_G11B GF4T INTERNAL 14 STANDARD 87KS BLACK DANISH TEXTURE	KB MP-10K26DK-442 DANISH GF4T	90.4IR07.S0D
--------------------------------------------------------------------------------------------------	-------------------------------	--------------

KEYBOARD GATEWAY GF4T_G11B GF4T INTERNAL 14 STANDARD 87KS BLACK DANISH TEXTURE	KB V121630AK1 DM DANISH GF4T	90.4IR07.C0D
--------------------------------------------------------------------------------------------------	------------------------------	--------------

KEYBOARD GATEWAY GF4T_G11B GF4T INTERNAL 14 STANDARD 87KS BLACK GERMAN TEXTURE	KB MP-10K26D0-442 GERMAN GF4T	90.4IR07.S0G
--------------------------------------------------------------------------------------------------	-------------------------------	--------------

KEYBOARD GATEWAY GF4T_G11B GF4T INTERNAL 14 STANDARD 87KS BLACK GERMAN TEXTURE	KB V121630AK1 GR GERMAN GF4T	90.4IR07.C0G
--------------------------------------------------------------------------------------------------	------------------------------	--------------

KEYBOARD GATEWAY GF4T_G11B GF4T INTERNAL 14 STANDARD 86KS BLACK US INTER- NATIONAL TEX- TURE	KB MP-10K23U4-442 US-INT GF4T	90.4IR07.S1D
-------------------------------------------------------------------------------------------------------------------	-------------------------------	--------------

KEYBOARD GATEWAY GF4T_G11B GF4T INTERNAL 14 STANDARD 86KS BLACK US INTER- NATIONAL TEX- TURE	KB V121630AS1 UI US-INT GF4T	90.4IR07.C1D
-------------------------------------------------------------------------------------------------------------------	------------------------------	--------------

CHAPTER 6: FRU (Field-Replaceable Unit) list

KEYBOARD GATEWAY GF4T_G11B GF4T INTERNAL 14 STANDARD 87KS BLACK SPANISH TEXTURE	KB MP-10K26E0-442 SPANISH GF4T	90.4IR07.S0S
KEYBOARD GATEWAY GF4T_G11B GF4T INTERNAL 14 STANDARD 87KS BLACK SPANISH TEXTURE	KB V121630AK1 SP SPANISH GF4T	90.4IR07.C0S
KEYBOARD GATEWAY GF4T_G11B GF4T INTERNAL 14 STANDARD 87KS BLACK FR/ARA- BIC TEXTURE	KB MP-10K26AF-442 FR/ARABIC GF4T	90.4IR07.S2A
KEYBOARD GATEWAY GF4T_G11B GF4T INTERNAL 14 STANDARD 87KS BLACK FR/ARA- BIC TEXTURE	KB V121630AK1 FA FRENCH/ARABIC GF4T	90.4IR07.C2A
KEYBOARD GATEWAY GF4T_G11B GF4T INTERNAL 14 STANDARD 87KS BLACK FRENCH TEXTURE	KB MP-10K26F0-442 FRENCH GF4T	90.4IR07.S0F
KEYBOARD GATEWAY GF4T_G11B GF4T INTERNAL 14 STANDARD 87KS BLACK FRENCH TEXTURE	KB V121630AK1 FR FRENCH GF4T	90.4IR07.C0F
KEYBOARD GATEWAY GF4T_G11B GF4T INTERNAL 14 STANDARD 86KS BLACK GREEK TEXTURE	KB MP-10K23GR-442 GREEK GF4T	90.4IR07.S0L
KEYBOARD GATEWAY GF4T_G11B GF4T INTERNAL 14 STANDARD 86KS BLACK GREEK TEXTURE	KB V121630AS1 GK GREEK GF4T	90.4IR07.C0L

KEYBOARD GATEWAY GF4T_G11B GF4T INTERNAL 14 STANDARD 87KS BLACK HUNGAR- IAN TEXTURE	KB MP-10K26HU-442 HUNGARIAN GF4T	90.4IR07.S0Q
KEYBOARD GATEWAY GF4T_G11B GF4T INTERNAL 14 STANDARD 87KS BLACK HUNGAR- IAN TEXTURE	KB V121630AK1 HG HUNGARIAN GF4T	90.4IR07.C0Q
KEYBOARD GATEWAY GF4T_G11B GF4T INTERNAL 14 STANDARD 86KS BLACK US INTER- NATIONAL W/ HEBREW TEX- TURE	KB MP-10K23HB-442 US-I/HEBR GF4T	90.4IR07.S0H
KEYBOARD GATEWAY GF4T_G11B GF4T INTERNAL 14 STANDARD 86KS BLACK US INTER- NATIONAL W/ HEBREW TEX- TURE	KB V121630AS1 HB US INT/HEBREW GF4T	90.4IR07.C0H
KEYBOARD GATEWAY GF4T_G11B GF4T INTERNAL 14 STANDARD 87KS BLACK ITALIAN TEXTURE	KB MP-10K26I0-442 ITALIAN GF4T	90.4IR07.S0E
KEYBOARD GATEWAY GF4T_G11B GF4T INTERNAL 14 STANDARD 87KS BLACK ITALIAN TEXTURE	KB V121630AK1 IT ITALIAN GF4T	90.4IR07.C0E
KEYBOARD GATEWAY GF4T_G11B GF4T INTERNAL 14 STANDARD 91KS BLACK JAPANESE TEXTURE	KB KB MP-10K20J0-442 JAPANESE GF4T	90.4IR07.S0J
KEYBOARD GATEWAY GF4T_G11B GF4T INTERNAL 14 STANDARD 91KS BLACK JAPANESE TEXTURE	KB V121630AJ1 JA JAPANESE GF4T	90.4IR07.C0J

CHAPTER 6: FRU (Field-Replaceable Unit) list

KEYBOARD GATEWAY GF4T_G11B GF4T INTERNAL 14 STANDARD 86KS BLACK KOREAN TEXTURE	KB MP-10K23K0-442 KOREAN GF4T	90.4IR07.S0K
KEYBOARD GATEWAY GF4T_G11B GF4T INTERNAL 14 STANDARD 86KS BLACK KOREAN TEXTURE	KB V121630AS1 KR KOREAN GF4T	90.4IR07.C0K
KEYBOARD GATEWAY GF4T_G11B GF4T INTERNAL 14 STANDARD 87KS BLACK NORWE- GIAN TEXTURE	KB MP-10K26N0-442 NORWEGIAN GF4T	90.4IR07.S0N
KEYBOARD GATEWAY GF4T_G11B GF4T INTERNAL 14 STANDARD 87KS BLACK NORWE- GIAN TEXTURE	KB V121630AK1 NW NORWEGIAN GF4T	90.4IR07.C0N
KEYBOARD GATEWAY GF4T_G11B GF4T INTERNAL 14 STANDARD 87KS BLACK NORDIC TEXTURE	KB MP-10K26DN-442 NORDIC GF4T	90.4IR07.S1K
KEYBOARD GATEWAY GF4T_G11B GF4T INTERNAL 14 STANDARD 87KS BLACK NORDIC TEXTURE	KB V121630AK1 NE NORDIC GF4T	90.4IR07.C1K
KEYBOARD GATEWAY GF4T_G11B GF4T INTERNAL 14 STANDARD 87KS BLACK PORTU- GUESE TEXTURE	KB MP-10K26P0-442 PORTUGUESE GF4T	90.4IR07.S06
KEYBOARD GATEWAY GF4T_G11B GF4T INTERNAL 14 STANDARD 87KS BLACK PORTU- GUESE TEXTURE	KB V121630AK1 PO PORTUGUESE GF4T	90.4IR07.C06

KEYBOARD GATEWAY GF4T_G11B GF4T INTERNAL 14 STANDARD 86KS BLACK RUSSIAN TEXTURE	KB MP-10K23SU-442 RUSSIAN GF4T	90.4IR07.S0R
KEYBOARD GATEWAY GF4T_G11B GF4T INTERNAL 14 STANDARD 86KS BLACK RUSSIAN TEXTURE	KB V121630AS1 RU RUSSIAN GF4T	90.4IR07.C0R
KEYBOARD GATEWAY GF4T_G11B GF4T INTERNAL 14 STANDARD 87KS BLACK SLO/CRO TEXTURE	KB MP-10K26SA-442 SLO/CRO GF4T	90.4IR07.S1F
KEYBOARD GATEWAY GF4T_G11B GF4T INTERNAL 14 STANDARD 87KS BLACK SLO/CRO TEXTURE	KB V121630AK1 SV SLOVENIA GF4T	90.4IR07.C1F
KEYBOARD GATEWAY GF4T_G11B GF4T INTERNAL 14 STANDARD 87KS BLACK SWEDEN TEXTURE	KB MP-10K26S0-442 SWEDEN GF4T	90.4IR07.S0W
KEYBOARD GATEWAY GF4T_G11B GF4T INTERNAL 14 STANDARD 87KS BLACK SWEDEN TEXTURE	KB V121630AK1 SD SWEDEN GF4T	90.4IR07.C0W
KEYBOARD GATEWAY GF4T_G11B GF4T INTERNAL 14 STANDARD 87KS BLACK SWISS/G TEXTURE	KB MP-10K26CH-442 SWISS/G GF4T	90.4IR07.S00
KEYBOARD GATEWAY GF4T_G11B GF4T INTERNAL 14 STANDARD 87KS BLACK SWISS/G TEXTURE	KB V121630AK1 SW SWISS GF4T	90.4IR07.C00

CHAPTER 6: FRU (Field-Replaceable Unit) list

KEYBOARD GATEWAY GF4T_G11B GF4T INTERNAL 14 STANDARD 86KS BLACK THAILAND TEXTURE	KB MP-10K23T0-442 THAILAND GF4T	90.4IR07.S03
KEYBOARD GATEWAY GF4T_G11B GF4T INTERNAL 14 STANDARD 86KS BLACK THAILAND TEXTURE	KB V121630AS1 TI THAILAND GF4T	90.4IR07.C03
KEYBOARD GATEWAY GF4T_G11B GF4T INTERNAL 14 STANDARD 87KS BLACK TURKISH TEXTURE	KB MP-10K26TQ-442 TURKISH GF4T	90.4IR07.S0T
KEYBOARD GATEWAY GF4T_G11B GF4T INTERNAL 14 STANDARD 87KS BLACK TURKISH TEXTURE	KB V121630AK1 TR TURKISH GF4T	90.4IR07.C0T
KEYBOARD GATEWAY GF4T_G11B GF4T INTERNAL 14 STANDARD 86KS BLACK CHINESE TEXTURE	KB MP-10K23RC-442 CHINESE GF4T	90.4IR07.S02
KEYBOARD GATEWAY GF4T_G11B GF4T INTERNAL 14 STANDARD 86KS BLACK CHINESE TEXTURE	KB V121630AS1 CH CHINESE GF4T	90.4IR07.C02
KEYBOARD GATEWAY GF4T_G11B GF4T INTERNAL 14 STANDARD 87KS BLACK US W/ CANADIAN FRENCH TEX- TURE	KB MP-10K26CU-442 USW/ CAN FREN GF4T	90.4IR07.S2M
KEYBOARD GATEWAY GF4T_G11B GF4T INTERNAL 14 STANDARD 87KS BLACK US W/ CANADIAN FRENCH TEX- TURE	KB V121630AK1 EF FRENCH/CANA- DIA/ENG GF4T	90.4IR07.C2M

KEYBOARD GATEWAY GF4T_G11B GF4T INTERNAL 14 STANDARD 87KS BLACK UK TEX- TURE	KB MP-10K26GB-442 UK GF4T	90.4IR07.S0U
------------------------------------------------------------------------------------------------	---------------------------	--------------

KEYBOARD GATEWAY GF4T_G11B GF4T INTERNAL 14 STANDARD 87KS BLACK UK TEX- TURE	KB V121630AK1 UK UK GF4T	90.4IR07.C0U
------------------------------------------------------------------------------------------------	--------------------------	--------------

LCD



LED LCD MODULE 14" WXGA GLARE IMR BLACK W/1.3M CAM- ERA&ANTENNA*2 & LOGO PLATE FOR PACKARD BELL	LCD NLED 14" WXGAG ANT*2 Ckk	6M.BRT01.003
----------------------------------------------------------------------------------------------------------------------	------------------------------	--------------

LED LCD AUO 14" WXGA+ GLARE B140XW01 V8 0A LF 220NIT 8MS 500:1	LCD 14"HD AU B140XW01 V8 G	LK.1400D.008
----------------------------------------------------------------------------	----------------------------	--------------

LED LCD SAM- SUNG 14" WXGA GLARE LTN140AT01-G04 LF 220NIT 8MS 500:1	LCD 14"HD SEC LTN140AT01-G04	LK.14005.010
------------------------------------------------------------------------------------	------------------------------	--------------

LED LCD LPL 14" WXGA GLARE LP140WH1-TLA2 LF 220NIT 8MS 500:1	LCD 14"HD LG LP140WH1-TLA2 LED	LK.14006.015
--------------------------------------------------------------------------	--------------------------------	--------------

LED LCD LPL 14" WXGA GLARE LP140WH4-TLC1 LF 220NIT 16MS	LCD 14" WXGA LG LP140WH4-TLC1	LK.14008.004
------------------------------------------------------------------	-------------------------------	--------------

LED LCD CMI 14" WXGA GLARE BT140GW01 V6 LF 220NIT 8MS 600:1	LCD 14"WXGA CMI BT140GW01 G	LK.14008.009
----------------------------------------------------------------------	-----------------------------	--------------

Camera



CAMERA 1.3M LIT- EON 10P2TF103	CAMERA 1.3M 10P2TF103 LITEON	56.18012.721
-----------------------------------	------------------------------	--------------

CAMERA 1.3M SUYIN HF1316-P80A-SS0 3	CAMERA 1.3M HF1316-P80A-SS03 SUYIN	56.18006.721
----------------------------------------------	------------------------------------	--------------

Microphone

	MICROPHONE	MIC CABLE JE40 HR XING MENG	23.42362.021
	MICROPHONE	MICROPHONE CABLE JE40 HR HIT	23.42362.001
	MICROPHONE	MICROPHONE CABLE JE40 HR GETTOP	23.42362.011

Mainboard

	MAINBOARD SJV40_HR ENNS11HR_UMA INTEL HM65 LF W/RTC BATTERY & W/O CPU & MEMORY NON-3G	SJV40_HR MB UMA NON3G PB	MB.BRV01.001
	MAINBOARD SJV40_HR ENNS11HR_N12P GS 1GB VRAM INTEL HM65 LF W/RTC BATTERY & W/O CPU & MEMORY NON-3G	SJV40_HR MB 12PGS/HY8/1G NON3G PB	MB.BRT01.001

Memory

	SODIMM 1GB DDRIII 1333MHZ KINGSTON ACR128X64D3S13 33C9 LF 128*8 0.065UM	SODIMM 1G ACR128X64D3S1333C9	KN.1GB0H.017
	SODIMM 1GB DDRIII 1333MHZ SAMSUNG M471B2873FHS-C H9 LF 128*8 46NM	SODIMM 1G M471B2873FHS-CH9	KN.1GB07.004
	SODIMM 1GB DDRIII 1333MHZ A-DATA AD7311A0873EU LF 128*8 0.065UM	SODIMM 1G AD7311A0873EU DDR3 1333MHZ	KN.1GB0B.035
	SODIMM 1GB DDRIII 1333MHZ UNIFOSA GU672203EP0200 LF 128*8 0.065UM	SODIMM 1G GU672203EP0200	KN.1GB0C.009
	SODIMM 2GB DDRIII 1333MHZ NT2GC64B88B0N S-CG LF 256*8 0.055UM	SODIMM 2G NT2GC64B88B0NS-CG	KN.2GB0G.018

	SODIMM 2GB DDRIII 1333MHZ KINGSTON ACR256X64D3S13 33C9 LF 128*8 0.065UM	SODIMM 2G ACR256X64D3S1333C9	KN.2GB03.021
	SODIMM 2GB DDRIII 1333MHZ ELPIDA EBJ21UE8BFU0-D J-F LF 128*8 0.065UM	SODIMM 2G EBJ21UE8BFU0-DJ-F	KN.2GB07.004
	SODIMM 2GB DDRIII 1333MHZ M471B5773CHS-C H9 LF 256*8 46NM	SODIMM 2G M471B5773CHS-CH9	KN.2GB09.009
	SODIMM 2GB DDRIII 1333MHZ A-DATA AD731B1674EU LF 128*8 0.065UM	SODIMM 2G AD731B1674EU DDR3 1333MHZ	KN.2GB0B.026
	SODIMM 2GB DDRIII 1333MHZ HYNIX HMT325S6BFR8C- H9 LF 256*8 46NM	SODIMM 2G HMT325S6BFR8C-H9N0	KN.2GB0C.006
	SODIMM 4GB DDRIII 1333MHZ ELPIDA EBJ41UF8BAS0-D J-F LF 256*8 0.055UM	SODIMM 4G EBJ41UF8BAS0-DJ-F	KN.4GB0G.003
	SODIMM 4GB DDRIII 1333MHZ SAMSUNG M471B5273CH0-C H9 LF 256*8 46NM	SODIMM 4G M471B5273CH0-CH9	KN.4GB09.001
	SODIMM 4GB DDRIII 1333MHZ HYNIX HMT351S6AFR8C- H9N0 LF 256*8 0.055UM	SODIMM 4G HMT351S6AFR8C-H9N0	KN.4GB0B.010
Miscellaneous			
	LCD BEZEL SCREW MYLAR	JM31 BEZLESCREWMYLAR JM	40.4HL07.001
	LCD BEZEL SCREW MYLAR	JM31_CP _BEZLE_SCREW_MYLAR	40.4HL07.011

CHAPTER 6: FRU (Field-Replaceable Unit) list

Screws

SCREW	SCREW M3x4(86.9A524.4R0)	86.9A524.4R0
SCREW M2.5X6 H=0.7~0.8MM	ISO M2.5X6(H=0.7~0.8MM)	86.00E12.536
SCREW M2*L3 BLACK ZN	M2*L3 BLACK ZN	86.FR901.001
SCRW TAPPING MACHINERY M2	SCRW TAPPING MACHINERY M2 LCASE SJV40	86.00P55.522
SCRW SELF-TAP- PING M1.4	SCRW SELF-TAPPING M1.4 UCASE SJV40	86.00P54.5Q2
SCREW M2.5*L5 BLACK ZN+NYLOK	M2.5*L5 BLACK ZN+NYLOK	86.TK501.001
SCREW M2.5X4L NI NYLOK	SCRW M2.5X4L NI NYLOK	86.00H36.534

APPENDIX A

Test compatible components

- [Introduction](#)
- [Microsoft® Windows 7® Compatibility Test](#)

Introduction

This notebook's compatibility is tested and verified by Acer's internal testing department. Refer to the following lists for components, adapter cards, and peripherals which have passed these tests.

Microsoft® Windows 7® Compatibility Test

Item	Device name	Vendor
I/O peripherals		
Access Point	Air Station Wireless NFINITI [ModeNum:WZR-G144N], 802.11n/g/b	Buffalo
	Buffalo Air Station NFINITI [ModeNum:WZR2-G300N], 802.11n/g/b	Buffalo
Bluetooth Access Point	Bluetooth Access Point [ModeNum:BT300]	X Bridge
Bluetooth Devices	Bluetooth Stereo Headset [ModeNum:HT820]	Motorola
	Bluetooth mouse [ModeNum:097855020512]	Logitech
	Motorola Bluetooth Wireless Headset H300	Motorola
	Sony Ericsson Stereo Bluetooth Headset HBH-DS970	Sony
External LCD	P243W 24-inch LCD Monitor	Acer
	P244W 24-inch LCD Monitor	Acer
	SP2208WFP 22-inch LCD Monitor	Dell
	UltraSharp 3008WFP 30-inch LCD Monitor	Dell
	2407FPW 24-inch LCD Monito	Dell
	UltraSharp E2408WFP 24-inch widescreen HDMI	Dell
Earphone / Microphone	Hawk Stereo Headset 933	Hawk
Projector	3300MP Projector	Dell
SIM Card	FarEasTone 3G SIM Card	FarEasTone
	Chunghwa Telecom 3G SIM Card	Chunghwa Telecom
TV	W37G (HDMI)	Westenhouse
	TC-37MPK (VGA/HDMI)	Panasonic
USB 3G Card	Huawei mobile connect E220 USB Modem 3G (E220: HSDPA/UMTS/EDGE/GPRS/GSM)	Huawei

Item	Device name	Vendor
USB Camera	Canon Digital IXUS 860 IS Digital Compact Camera (8.0 Megapixel CCD sensor/DIGIC III with Face Detection AF/AE/FE/28mm wide-angle lens with optical Image Stabilizer, Media storage:SD,SDHC,MMC,MMCplus, built-in SD32MB)	Canon
USB Flash Drive	Transcend JetFlash USB2.0 Flash Drive V85 8GB Memory Key	Transcend
	Apacer AH421 8GB	Apacer
	A-Data PD16 Vista 16GB	A-Data
	Transcend JetFlash USB2.0 Flash Drive V10 16GB Memory Key	Transcend
USB HDD	2.5-inch Portable 80GB Hard Disk	Transcend
USB Hub and Others	Huawei mobile connect E220 USB Modem 3G (E220: HSDPA/UMTS/EDGE/GPRS/GSM)	Huawei
	PowerSync USB2.0 4-Port mini HUB(HU151W White)	PowerSync
	Techworks 4-Port USB2.0 Mini HUB(OW4PTUSBHB)	Techworks
USB Keyboard / Mouse	First Wheel Mouse	Logitech
	Internet Navigator Keyboard	Logitech
	Dell L30U 0N242F USB Keybaord	Dell
USB ODD	DVD+R/RW (Usb2.0)	Plextor
USB Printer	HP Deskjet F4280 All-in-One:Printer/ Scanner/Copier, 1200x2400dpi)	HP
USB Speaker / Joystick	iFun USB Speaker(JS1200UA)	JS
	Dell USB Speaker	Dell
USB Storage Drive	6 IN 1 Flash Card Reader/Writer	PQI
Wireless Printer	Photosmart C309 (CC35A) All-in-One Printer (4x6 photos/CD/DVD/Quick Forms)/Scanner/Copier/Fax) Port: USB2.0/Ethernet/PictBridge/802.11g/BT	HP
	Photosmart C4580 All-in-One Printer (4x6 photos) /Scanner/Copier Port:USB2.0/802.11g.b/Memory Card	HP
Memory Card		
Memory Stick	High speed 1GB Memory stick Pro Duo	Lexar
	MS PRO Dou 2GB High Speed	SONY
	MS PRO 2GB Memory Card	SONY
	SanDisk Meomry Stick Micro (M2) 8GB Card	SanDisk

APPENDIX A: Test compatible components

Item	Device name	Vendor
Multimedia Card	RS-MMC 128MB Memory Card	Sandisk
	RS-MMC Mobile 256MB Memory Card	PQI
	Transcend MMC plus 4GB Card	Transcend
	Turbo 200X 2GB MMC Card	A-DATA
SD Card	4GB SD PRO Memory Card	RiDATA
	SanDisk multi-use SD Class2 Memory Card 2GB	SanDisk
	SD card 2GB (150x Hi-Speed)	Apacer
	SanDisk microSDHC 4GB Card with Adapter	SanDisk
	Kingston SDHC SD4 32GB Card	Kingston
XD Card	OLYMPUS XD-Picture Card M+ 2GB Speed Card	OLYMPUS
	FUJIFLM XD-Picture Card TypeM 2GB	FUJIFLM

APPENDIX B

Online support information

This section describes online technical support services available to help you repair your Packard Bell notebook.

If you are a distributor, dealer, ASP, or TPM, please refer your technical queries to your local Acer branch office. Acer branch offices and Regional Business Units may access our website. However some information sources will require a user id and password. These can be obtained directly from Acer CSD Taiwan.

Acer's website offers you convenient and valuable support resources whenever you need them. In the Technical Information section you can download information on all of Acer's Notebook, Desktop and Server models including:

- Service guides for all models
- User's manuals
- Training materials
- BIOS updates
- Software utilities
- Spare parts lists
- TABs (Technical Announcement Bulletin)

For these purposes, we have included an Acrobat File to facilitate the problem-free downloading of our technical material. Also contained on this website are:

- Detailed information on Acer's International Traveller's Warranty (ITW)
- Returned material authorization procedures
- An overview of all the support services we offer, accompanied by a list of telephone, fax and email contacts for all your technical queries.

We are always looking for ways to optimize and improve our services, so if you have any suggestions or comments, please do not hesitate to communicate these to us.

Index

A

- antennas
 - replace 92
- audio
 - controller 12
 - resolution 12

B

- battery
 - remove 38
- bay cover
 - remove 39
- BIOS
 - password control 8
 - supported protocols 8
 - vendor 7
 - version 7
- BIOS crisis disk 28
- BIOS flash 29
- BIOS recovery
 - BIOS flash 29
 - crisis disk 28
 - precautions 28
 - procedure 28
- BIOS utility
 - access 18
 - Boot menu 26
 - Exit menu 27
 - Information menu 20
 - Main menu 21
 - navigate 19
 - Security menu 22
- Bluetooth
 - chipset 13
 - module, replace 65
- boot sequence 26
- buttons
 - specification 14

C

- card reader
 - remove card 37
- chipset
 - Bluetooth 13
 - USB 13
 - wired Ethernet 12
 - wireless Ethernet 13
- component replacement
 - antennas 92
 - battery 38
 - bay cover 39
 - Bluetooth module 65

- cooling assembly 70
- ESD prevention 34
- hard drive 41
- keyboard 53
- LCD assembly lid 94
- LCD front panel 79
- LCD panel 84
- LCD panel assembly 76
- LCD panel hinge brackets 88

- memory 45
- microphone 90
- optical drive 46
- palm rest 48
- power button board 61
- preparatory steps 37
- processor 73
- safety reminders 34
- speakers 58
- system board 67
- tape 34
- tools 36
- touchpad/fingerprint reader board 51
- USB board 63
- webcam 82
- wireless card 43
- work space 35
- conductive tape 34
- connections
 - specification 14
- controller
 - audio 12
 - keyboard 11
 - memory card reader 12
- cooling assembly
 - replace 70

D

- D2D Recovery 22
- display 6

E

- electrostatic discharge 34
- error symptom-to-spare part index 102
- ESD, see electrostatic discharge 34
- external CD-ROM drive check 99

F

- features 3

H

- hard drive
 - HDD password 23
 - replace 41
- hard drive bracket
 - remove 42
- HDD password
 - description 23

I

- intermittent problems 114

K

- keyboard
 - controller 11
 - replace 53
- keyboard or auxiliary input
 - device check 99

L

- LCD assembly lid
 - replace 94
- LCD front panel
 - replace 79
- LCD panel
 - replace 84
- LCD panel assembly
 - replace 76
- LCD panel hinge brackets
 - replace 88

M

- memory
 - install 45
 - remove 45
- memory card
 - remove 37
- memory card reader
 - controller 12
 - supported cards 12
- memory check 100
- microphone
 - replace 90
- mylar tape 34

O

- optical drive
 - replace 46
- optical drive bezel
 - remove 47
- optical drive bracket

- remove 47
- P**
- palm rest
 - replace 48
- password
 - change 24
 - clear hardware gap 30
 - guidelines 23
 - HDD, description 23
 - Password on Boot 23
 - remove 25
 - set 23
 - supervisor, description 23
- Password on Boot 23
- physical specifications 5
- power button board
 - replace 61
- power system check 100
 - battery pack 101
 - power adapter 100
- processor
 - replace 73
- S**
- security features
 - BIOS passwords 23
- speakers
 - replace 58
- specification
 - buttons 14
 - ports 14
 - status indicators 14
- status indicators
 - specification 14
- supervisor password
 - change 24
 - clear 30
 - description 23
 - remove 25
 - set 23
- system
 - block diagram 6
 - check procedures 99
- system board
 - bottom view 119, 120
 - replace 67
 - top view 118
- T**
- touchpad
 - check 101
- touchpad / fingerprint reader
 - board
 - replace 51
- U**
- undetermined problems 115
- USB
 - chipset 13
- USB board
 - replace 63
- user password
 - change 24
 - clear 30
 - remove 25
 - set 24
- utilities
 - BIOS setup utility 18
- W**
- webcam
 - replace 82
- wired Ethernet
 - chipset 12
- wireless card
 - replace 43
- wireless Ethernet
 - chipset 13

MAN NV5x SVC GDE R1 04/09



8513195

TEMP
UPC

Free Manuals Download Website

<http://myh66.com>

<http://usermanuals.us>

<http://www.somanuals.com>

<http://www.4manuals.cc>

<http://www.manual-lib.com>

<http://www.404manual.com>

<http://www.luxmanual.com>

<http://aubethermostatmanual.com>

Golf course search by state

<http://golfingnear.com>

Email search by domain

<http://emailbydomain.com>

Auto manuals search

<http://auto.somanuals.com>

TV manuals search

<http://tv.somanuals.com>