

Palm Modem[®] Handbook



Copyright

Copyright © 1997-1999 3Com Corporation or its subsidiaries. All rights reserved. 3Com, the 3Com logo, HotSync, Megahertz, and Palm Modem are registered trademarks, and the HotSync logo, Palm, the Palm Computing Platform logo, and Palm OS are trademarks of Palm Computing, Inc., 3Com Corporation or its subsidiaries. Other product and brand names may be trademarks or registered trademarks of their respective owners.

Disclaimer

3Com Corporation and its subsidiaries assume no responsibility for any damage or loss resulting from the use of this handbook.

3Com Corporation and its subsidiaries assume no responsibility for any loss or claims by third parties which may arise through the use of this product. 3Com Corporation and its subsidiaries assume no responsibility for any damage or loss caused by deletion of data as a result of malfunction, dead battery, or repairs. Be sure to make backup copies of all important data on other media to protect against data loss.

P/N: 405-0273-01D

A/N: 423-0211-01

Contents

Chapter 1: Introduction

What can I do with my Palm Modem accessory?	1
---	---

Chapter 2: Setting Up And Using Your Palm Modem® Accessory

Installing the batteries	3
Attaching Palm Modem accessory and cables	4
Configuration for remote HotSync® and Network HotSync operations	5
Using your Palm Modem accessory	9
Detaching your Palm Modem accessory	9

Appendix: Warranty and Regulatory Information	9
---	---

Chapter 1

Introduction

Palm Modem® accessory enables you to send and receive data at your convenience. You don't have to connect your Palm connected organizer directly to your computer or laptop to update your data.

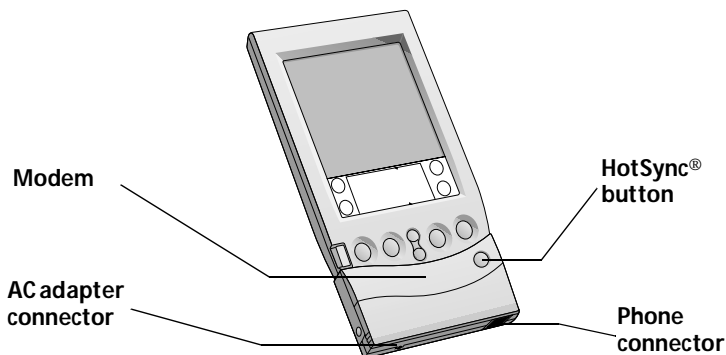

What can I do with my Palm Modem accessory?

With your modem and organizer from remote locations you can:

- Synchronize your organizer and Palm™ Desktop organizer software via a PC modem with one touch.
- Synchronize your organizer and Palm™ Desktop organizer software via your company's Local Area Network (LAN) or dial-in (RAS) server using the Network HotSync application and TCP/IP.

Also, there are many software applications available from third-party vendors that enable you to use your organizer and modem to:

- Send and receive e-mail.
- Send faxes.
- Browse the Internet.
- Perform remote synchronizations with your Personal Information Manager (PIM), such as Lotus Organizer, Symantec ACT, and Microsoft Outlook using HotSync technology or the Network HotSync application.

Contact the third-party vendors below for more information about some of the software applications you can use with your organizer and modem.

Use	Application	Description	Vendor
E-mail	Network HotSync	Supports remote access to your e-mail and Palm™ Desktop organizer software using either your company's existing LAN or dial-in (RAS) server	3Com www.palm.com
	HandMail	Supports SMTP and POP3 e-mail protocols	SmartCode Software, Inc. www.smartcodesoft.com
	MultiMail Pro	Supports SMTP, POP3, and IMAP4 protocols	Actual Software www.actualsoft.com
	One Touch	Supports SMTP and POP3 e-mail protocols	JP Systems www.jpsystems.com
	Palmeta Mail	Supports Netscape Mail or any MAPI e-mail system	Palmeta Software www.palmeta.com
Fax	HandFax	Supports standard Class 2/2.0 fax machines	SmartCode Software, Inc. www.smartcodesoft.com
Internet browsing	HandWeb	Browses, surfs, and navigates the Internet	SmartCode Software, Inc. www.smartcodesoft.com
Remote synchronization	Desktop To Go	Supports Microsoft Outlook	DataViz www.dataviz.com
	EasySync for Lotus Notes	Supports Lotus Notes	Lotus www.lotus.com
	EasySync for Lotus Organizer	Supports Lotus Organizer	Lotus www.lotus.com
	Intellisync	Supports Microsoft Outlook, Symantec ACT, GoldMine, Lotus Notes, Lotus Organizer, and Meeting Maker	Tele-Support Software www.pumatech.com
	Now Synchronize	Supports Now Up to Date	Now Software www.nowsoft.com
	PocketMirror	Supports Microsoft Outlook	Chapura, Inc. www.chapura.com

Chapter 2

Setting Up And Using Your Palm Modem® Accessory

Before you use your Palm Modem® accessory, you must:

- Install the batteries.
Note: The batteries may already be installed.
- Attach your modem to your organizer.
- Connect an analog phone cable to your modem.
- Configure your computer.
- Configure your organizer.

Installing the batteries

To use your modem, you must first install two AAA alkaline batteries. The batteries fit in the compartment behind the battery door on the front of the modem. Make sure to click the door into place after installing the batteries.

Note: A diagram in the interior of the battery compartment shows the orientation of the positive (+) and negative (-) ends of the batteries. When correctly installed, the clips in the battery compartment secure the batteries in place.

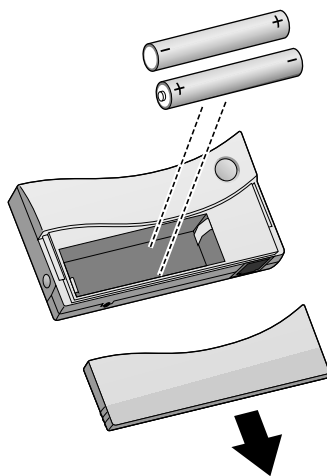

Replacing batteries

Under normal conditions, the AAA batteries provide up to five hours of continuous use. When your modem has approximately four minutes of battery life remaining it will sound three short beeps, which repeat every minute until the batteries are drained. Replace the batteries as soon as possible.

Attaching Palm Modem accessory and cables

Your modem has a 10-pin connector that slides into the grooves of your organizer connector. Make sure your modem snaps into place onto the organizer. Use a standard RJ11 cable to connect to an analog phone line.

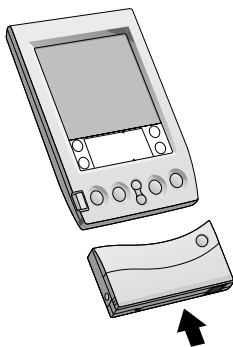

**Slide into connector
and snap into place**

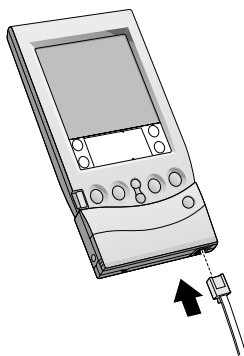

Insert phone cable

Note: It is important to use a standard analog phone line, such as those used in homes. If you use your modem in an office or hotel, make sure it is connected to a phone line with a data port, a fax line, or a modem line. If you use a digital phone line, your modem emits three beeps. Disconnect the cable and try a different line.

Configuration for remote HotSync® and Network HotSync operations

You can use your Palm Modem accessory and your computer modem to perform remote HotSync® operations, or synchronize your e-mail on your computer. You can also use your Palm Modem accessory and the Network HotSync application to access your e-mail and other data using your company's existing LAN or dial-in (RAS) server. Contact your System Administrator to set up the Network HotSync application, or for more information on using the Network HotSync application, go to this web site: <http://www.palm.com>. The Network HotSync application is available only in the US.

Setting your computer preferences

Before you can use your modem, you must prepare your computer to accept the incoming call, and make sure Palm™ Desktop organizer software settings are correct.

Important: Remember to leave your computer running so you can perform remote operations.

To set up your PC for a remote HotSync or Network HotSync operation:

1. Click the HotSync Manager icon ™ from the System Tray (bottom-right corner of the taskbar).
2. In the HotSync Manager menu in the System Tray, make sure Modem is checked.
Or, if you want to synchronize using the Network HotSync application, make sure Network is checked. You can skip steps 3 through 5 and continue by setting your organizer preferences.
3. From the HotSync Manager menu in the System Tray, choose Setup.
4. Click the Modem tab and adjust the connection setting options as needed.
5. Click OK.

To set up your Macintosh for a remote HotSync operation:



1. Click the HotSync Manager icon  from the Instant Palm Desktop menu (upper-right corner of your screen).
2. From the HotSync menu, select HotSync Setup, and on the Serial Port Settings tab make sure Modem is checked.
3. Adjust the Modem Setup options as needed.
4. From the File menu, choose Quit.

Setting your organizer preferences

Since your Palm Modem accessory uses the Modem Sync software that is resident in your organizer to establish a phone connection with another modem, you must configure your organizer phone settings.

Note: Some organizers may have different icons from the ones shown below. Note the icon name and tap the appropriate icon on your organizer.

To set your organizer preferences for modem operations:

1. Tap the Applications icon .
2. Tap the HotSync icon .
3. Tap the Enter Phone # field.
4. Enter the telephone number to access the modem connected to your computer.
5. If needed, enter a dial prefix (such as “9”) to access an outside line, and then tap the Dial Prefix check box.

Tip: You can enter a comma in the field to introduce a “pause” in the dialing sequence. Each comma equals a two second pause.

6. If the phone line you’re using for the organizer has Call Waiting, select the Disable call waiting check box to avoid an interruption during the modem HotSync operation.
7. If you want to use a calling card to place the call, select the check box and enter the calling card number.
8. Tap OK.
9. Tap the Menu icon .
10. Tap Options, and then tap Modem Setup.

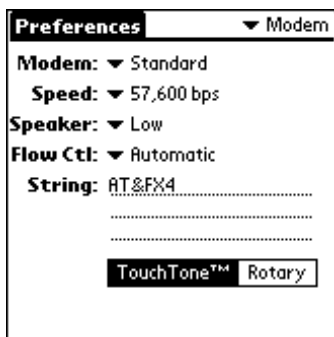

11. Select the Modem type and adjust the other options as needed.



Modem	Select Palm US/Canada if you are using the modem in Canada or the US, select Palm U.K. if you are using the modem in the U.K., or select a modem type. The custom setting is for advanced modem users and is created automatically when AT commands are entered in the String field. Note: For the Pilot 1000 or Pilot 5000, select the Megahertz® modem
Speed	Determines the modem speed for downloading data. Even though the modem is rated at 14,400 bps we recommend you choose 57,600 bps to obtain the fastest performance for your modem.
Speaker	Controls the modem speaker volume.
Flow Ctl	Regulates the data sent to your modem. When your modem receives data, it holds the data in its buffer until the data is ready to be sent. If your modem receives more data than its buffer can hold, the modem will use flow control to temporarily stop data transmission.
String	For advanced users only. The field is used for standard AT commands that enable the modem to perform special functions.
TouchTone/ Rotary	Select the Rotary setting only if you are certain that your telephone service does not support TouchTone dialing.

Additional settings for the Network Hotsync application

If you want to use the Network Hotsync application to access data, you will also need to adjust your organizer preferences to use a network.

Note: Before performing a Network HotSync operation, the Network HotSync application must be installed, enabled, and a local HotSync operation must be performed.

To prepare your organizer for a Network HotSync operation:

1. Tap the Applications icon .
2. Tap the HotSync icon .
3. Tap the Menu icon .
4. Tap Options, then tap Modem Sync Prefs.
5. Tap Network.
6. Tap OK.

Using your Palm Modem accessory

Now when you leave the office, you can use your Palm Modem accessory to stay connected. Use the software installed on your organizer to synchronize data between your organizer and your computer. Press the HotSync button on the front of your modem to initiate remote HotSync operations.

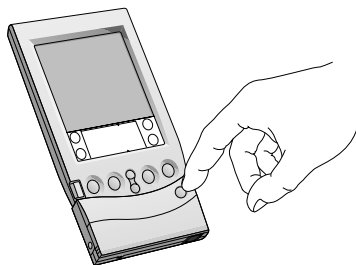

Important: Remember to leave your computer running so you can perform remote operations.

Detaching your Palm Modem accessory

When you have completed your modem operations, press the buttons on either side of the modem, then slide the modem away from the organizer.

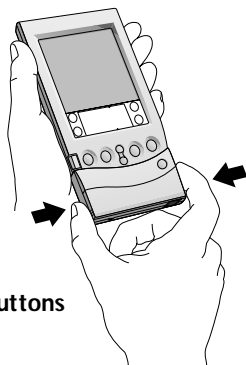

Press buttons

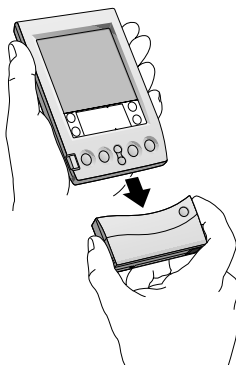

Pull modem from organizer

Appendix

Warranty and Regulatory Information

Limited warranty

HARDWARE: Palm Computing, Inc., a subsidiary of 3Com Corporation (collectively "3Com"), warrants to the original end user ("Customer") that this product will be free from defects in workmanship and materials, under normal use, for one year from the date of original purchase from 3Com or its authorized reseller. 3Com's sole obligation under this express warranty shall be, at 3Com's option and expense, to replace the product or part with a comparable product or part, repair the product or part, or if neither repair nor replacement is reasonably available, 3Com may, in its sole discretion, refund to Customer the purchase price paid for the product or part. Replacement products or parts may be new or reconditioned. 3Com warrants any replaced or repaired product or part, and any hardware upgrade to which Customer is entitled under an agreement between Customer and 3Com, for a period of ninety (90) days from shipment, or through the end of the original warranty, whichever is longer. All products or parts that are replaced become the property of 3Com.

Accessory products, as listed in the applicable 3Com catalogue, are not covered under this Limited Warranty except for the modem for the connected organizer, the cradles, cables, memory upgrades, and leather items sold under the 3Com® brand. 3Com shall not be responsible for Customer's software, firmware, information, or memory data contained in, stored on, or integrated with any products returned to 3Com for repair, whether under warranty or not.

SOFTWARE: 3Com warrants to Customer that the Palm™ Desktop organizer software and Palm OS™ software licensed from it will perform in substantial conformance to their program specifications, for a period of ninety (90) days from the date of original purchase from 3Com or its authorized reseller. 3Com warrants the media containing software against failure during the warranty period. No updates are provided. 3Com does not provide any warranty for Adobe® Acrobat® Reader or any other third-party applications software that is licensed to Customer by the third party. 3Com's sole obligation with respect to this express warranty shall be (at 3Com's discretion) to refund the purchase price paid by Customer for any defective software product, or to replace any defective media with software which substantially conforms to applicable 3Com published specifications. 3Com makes no warranty or representation that its software products will meet Customer's requirements or will work in combination with any hardware or applications software products provided by third parties, that the operation of the software products will be uninterrupted or error free, or that all defects in the software products will be corrected.

OBTAINING WARRANTY SERVICE: Customer must contact a Palm Computing, Inc. or 3Com Technical Support or Customer Service center within the applicable warranty period to obtain warranty service authorization. Dated proof of original purchase from 3Com or its authorized reseller will be required. 3Com is not responsible for Customer products or parts received without a warranty service authorization. In the United States, 3Com may ship a replacement product or part prior to receiving the original product or part ("advance exchange"). If advance exchange is not available, then the repaired product or part will be shipped as soon as reasonably possible, which will be no later than thirty (30) days after 3Com receives the original product or part. Repaired or replacement products will be shipped to Customer at 3Com's expense. The repair and replacement process for products or parts in locations outside of the United States will vary depending on Customer's location.

Products or parts shipped by Customer to 3Com must be sent prepaid and packaged appropriately for safe shipment, and it is recommended that they be insured or sent by a method that provides for tracking of the package. When an advance exchange is provided and Customer fails to return the original product or part to 3Com within thirty (30) days from the date the warranty service authorization is issued, 3Com will charge Customer the then-current published catalogue price of such product or part.

WARRANTIES EXCLUSIVE: IF THIS PRODUCT DOES NOT OPERATE AS WARRANTED ABOVE, CUSTOMER'S SOLE REMEDY FOR BREACH OF THAT WARRANTY SHALL BE REPLACEMENT OR REPAIR OF THE PRODUCT OR PART OR REFUND OF THE PURCHASE PRICE PAID, AT 3COM'S OPTION. TO THE FULL EXTENT ALLOWED BY LAW, THE FOREGOING WARRANTIES AND REMEDIES ARE EXCLUSIVE AND ARE IN LIEU OF ALL OTHER WARRANTIES, TERMS, OR CONDITIONS, EXPRESS OR IMPLIED, EITHER IN FACT OR BY OPERATION OF LAW, STATUTORY OR OTHERWISE, INCLUDING WARRANTIES, TERMS, OR CONDITIONS OF MERCHANTABILITY, FITNESS FOR A PARTICULAR PURPOSE, SATISFACTORY QUALITY, CORRESPONDENCE WITH DESCRIPTION, AND NON-INFRINGEMENT, ALL OF WHICH ARE EXPRESSLY DISCLAIMED. 3COM NEITHER ASSUMES NOR AUTHORIZES ANY OTHER PERSON TO ASSUME FOR IT ANY OTHER LIABILITY IN CONNECTION WITH THE SALE, INSTALLATION, MAINTENANCE OR USE OF ITS PRODUCTS.

3COM SHALL NOT BE LIABLE UNDER THIS WARRANTY IF ITS TESTING AND EXAMINATION DISCLOSE THAT THE ALLEGED DEFECT OR MALFUNCTION IN THE PRODUCT DOES NOT EXIST OR WAS CAUSED BY CUSTOMER'S OR ANY THIRD PERSON'S MISUSE, NEGLIGENCE, IMPROPER INSTALLATION OR TESTING, UNAUTHORIZED ATTEMPTS TO OPEN, REPAIR, OR MODIFY THE PRODUCT, OR ANY OTHER CAUSE BEYOND THE RANGE OF THE INTENDED USE, OR BY ACCIDENT, FIRE, LIGHTNING, OTHER HAZARDS, OR ACTS OF GOD. THIS WARRANTY DOES NOT COVER PHYSICAL DAMAGE TO THE SURFACE OF THE PRODUCT, INCLUDING CRACKS OR SCRATCHES ON THE LCD TOUCHSCREEN OR OUTSIDE CASING. THIS WARRANTY DOES NOT APPLY WHEN THE MALFUNCTION RESULTS FROM THE USE OF THIS PRODUCT IN CONJUNCTION WITH ACCESSORIES, OTHER PRODUCTS, OR ANCILLARY OR PERIPHERAL EQUIPMENT AND 3COM DETERMINES THAT THERE IS NO FAULT WITH THE PRODUCT ITSELF. THIS WARRANTY DOES NOT APPLY TO ANY MALFUNCTION OR FAILURE OF THE PRODUCT OR PART DUE TO ANY COMMUNICATION SERVICE CUSTOMER MAY SUBSCRIBE TO OR USE WITH THE PRODUCT.

LIMITATION OF LIABILITY: TO THE FULL EXTENT ALLOWED BY LAW, 3COM ALSO EXCLUDES FOR ITSELF AND ITS SUPPLIERS ANY LIABILITY, WHETHER BASED IN CONTRACT OR TORT (INCLUDING NEGLIGENCE), FOR INCIDENTAL, CONSEQUENTIAL, INDIRECT, SPECIAL, OR PUNITIVE DAMAGES OF ANY KIND, OR FOR LOSS OF REVENUE OR PROFITS, LOSS OF BUSINESS, LOSS OF INFORMATION OR DATA, OR OTHER FINANCIAL LOSS ARISING OUT OF OR IN CONNECTION WITH THE SALE, INSTALLATION, MAINTENANCE, USE, PERFORMANCE, FAILURE, OR INTERRUPTION OF THIS PRODUCT, EVEN IF 3COM OR ITS AUTHORIZED RESELLER HAS BEEN ADVISED OF THE POSSIBILITY OF SUCH DAMAGES, AND LIMITS ITS LIABILITY TO REPLACEMENT, REPAIR, OR REFUND OF THE PURCHASE PRICE PAID, AT 3COM'S OPTION. THIS DISCLAIMER OF LIABILITY FOR DAMAGES WILL NOT BE AFFECTED IF ANY REMEDY PROVIDED HEREIN SHALL FAIL OF ITS ESSENTIAL PURPOSE.

DISCLAIMER: Some countries, states, or provinces do not allow the exclusion or limitation of implied warranties or the limitation of incidental or consequential damages for certain products supplied to consumers, or the limitation of liability for personal injury, so the above limitations and exclusions may be limited in their application to you. When the implied warranties are not allowed to be excluded in their entirety, they will be limited to the duration of the applicable written warranty. This warranty gives you specific legal rights which may vary depending on local law.

GOVERNING LAW: This Limited Warranty shall be governed by the laws of the State of California, U.S.A. excluding its conflicts of laws principles and excluding the United Nations Convention on Contracts for the International Sale of Goods.

Palm Computing, Inc., a subsidiary of 3Com Corporation
5400 Bayfront Plaza
PO Box 58007
Santa Clara, California 95052-8007
United States of America
(408) 326-5000
September 3, 1998

FCC-68

This equipment complies with Part 68 of the FCC rules. A label is affixed to the equipment that contains, among other things, the FCC registration number, USOC and Ring-er Equivalency Number (REN) for this equipment. If these numbers are requested, provide this information to your telephone company.

The REN is useful to determine the quantity of devices you may connect to your telephone line and still have those devices ring when your number is called. In most, but not all areas, the sum of the RENs of all devices should not exceed five (5.0). To be certain of the number of devices you may connect to your line, as determined by the REN, you should call your local telephone company to determine the maximum REN for your calling area.

If the equipment causes harm to the telephone network, the telephone company may discontinue your service temporarily. If possible, they will notify you in advance; if advance notice is not practical, you will be notified as soon as possible. You will be advised of your right to file a complaint with the FCC.

Your telephone company may make changes in its facilities, equipment, operations, or procedures that could affect the proper operation of your equipment. If they do, you will be given advance notice to give you an opportunity to maintain uninterrupted service.

If you experience trouble with this product, contact your Authorized Reseller, or call 3Com at (847) 676-1441. You may be required to present proof of purchase.

The telephone company may ask you to disconnect the equipment from the network until the problem has been corrected, or until you are sure the equipment is not malfunctioning.

No customer repairs are possible to the equipment. If you experience trouble with the equipment, contact your Authorized Reseller.

This equipment may not be used on coin service provided by the telephone company. Connection to party lines is subject to state tariffs. Contact your state public utility commission or corporation commission for information.

When ordering network interface (NI) service from the local Exchange Carrier, specify service arrangement USOC RJ11C.

FCC-15

This equipment has been tested and found to comply with the limits for a Class B digital device, pursuant to Part 15 of the FCC Rules. These limits are designed to provide reasonable protection against harmful interference in a residential installation. This equipment generates, uses, and can radiate radio frequency energy and, if not installed and used in accordance with the instructions, may cause harmful interference to radio communications. However, there is no guarantee that interference will not occur in a particular installation. If this equipment does cause harmful interference to radio or television reception, which can be determined by turning the equipment off and on, the user is encouraged to try to correct the interference by one or more of the following measures:

- Reorient or relocate the receiving antenna.
- Increase the separation between the equipment and receiver.
- Connect the equipment into an outlet on a circuit different from that to which the receiver is connected.
- Consult a 3Com authorized dealer or service representative for help.

3Com is not responsible for any radio or television interference caused by using other than recommended cables and connectors or by unauthorized changes or modifications to this equipment. Unauthorized changes or modifications could void the user's authority to operate the equipment.

This device complies with Part 15 of the FCC Rules. Operation is subject to the following two conditions:

1. This device may not cause harmful interference, and
2. This device must accept any interference received, including interference that may cause undesired operation.

Note: This device was tested to comply with FCC-15 Class B requirements.

Manufacturers Declaration of Conformity

Palm Computing, Inc., a subsidiary of
3Com Corporation
5400 Bayfront Plaza
PO Box 58007
Santa Clara, CA 95052-8007
(408) 326-5000

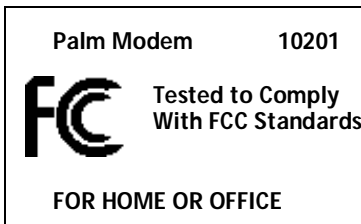

Declares this product:

Date: February, 1999

Name: Palm Modem

Model Number: 10201

Equipment Type: Modem

Complies with Part 15 of the FCC rules. Operation is subject to the following two conditions:

1. This device may not cause harmful interference, and
2. This device must accept any interference received, including interference that may cause undesired operation.

Industry Canada (ICES-003)

This Class B digital apparatus meets all requirements of the Canadian Interference-Causing Equipment Regulations.

Note: This device was tested to comply with FCC-15 Class B requirements in the cases of the following configurations:

- (a) Modem

The user must use the accessories and cables supplied by the manufacturer to get optimum performance from the product.

Industry Canada (CS-03)

The Canadian Department of Communications label identifies certified equipment. This certification means that the equipment meets certain telecommunications network protective, operational, and safety requirements. The Department does not guarantee the equipment will operate to the user's satisfaction.

Before installing this equipment, users should ensure that it is permissible to be connected to the facilities of the local telecommunications company. The equipment must also be installed using an acceptable method of connection. In some cases, the company's inside wiring associated with a single line individual service may be extended by means of a certified connector assembly (telephone extension cord). The customer should be aware that compliance with the above conditions may not prevent degradation of service in some situations.

Repairs to certified equipment should be made by an authorized Canadian maintenance facility designated by the supplier. Any repairs or alterations made by the user to this equipment, or equipment malfunctions, may give the telecommunications company cause to request the user to disconnect the equipment.

Users should ensure for their own protection that the electrical ground connections of the power utility, telephone lines, and internal metallic water pipe system, if present, are connected together. This precaution may be particularly important in rural areas.

CAUTION: Users should not attempt to make such connections themselves, but should contact the appropriate electric inspection authority, or electrician, as appropriate.

NOTICE: The LOAD NUMBER (LN) assigned to each terminal device denotes the percentage of the total load to be connected to a telephone loop which is used by the device, to prevent overloading. The termination on a loop may consist of any combination of devices subject only to the requirement that the sum of the LOAD NUMBERS of all the devices does not exceed 100.

CE Mark

Electromagnetic compatibility

This product is in conformity with the protection requirements of EC Council Directive 89/336/EEC on the approximation of the laws of the Member States relating to electromagnetic compatibility. 3Com cannot accept responsibility for any failure to satisfy the protection requirements resulting from a non-recommended modification of the product, including the fitting of non-3Com option cards.

This product has been tested and found to comply with the limits for Class B Information Technology Equipment according to CISPR 22 / European Standard EN 55022. The limits for Class B equipment were derived for typical residential environments to provide reasonable protection.

Safety

This device to which this declaration relates has been tested and is in conformity with the following standards.

- EN60950 according to the requirements of Low Voltage Directive 73/23/EEC
- EN55022 Class B and EN50082-1 according to requirements of EMC Directive 89/336/EEC

Free Manuals Download Website

<http://myh66.com>

<http://usermanuals.us>

<http://www.somanuals.com>

<http://www.4manuals.cc>

<http://www.manual-lib.com>

<http://www.404manual.com>

<http://www.luxmanual.com>

<http://aubethermostatmanual.com>

Golf course search by state

<http://golfingnear.com>

Email search by domain

<http://emailbydomain.com>

Auto manuals search

<http://auto.somanuals.com>

TV manuals search

<http://tv.somanuals.com>