

OWNER'S MANUAL

Palsonic

34CM CORDLESS REMOTE COLOUR TELEVISION
MODEL: 3499



Type Tested
Electrical
Safety

AS/NZS 3250 Lic 4163
Standards Australia
APP No: N15957

PALSONIC CORPORATION PTY LTD
1 JOYNTON AVENUE
WATERLOO NSW 2017 AUSTRALIA
TEL:(02)9313 7111
FAX:(02)9313 7555
www.palsonic.com.au

**PALSONIC CUSTOMER SERVICE
TELEPHONE
AUSTRALIA:1300 657 888**

Congratulations on your purchase of this colour Hi-Vision Palsonic television receiver. We recommend that you thoroughly read this manual before use to fully enjoy the many functions and excellent effects of this receiver. Retain is manual in an easily accessible location for future reference.

Contents

| | |
|--|-----------|
| NOTES FOR OPERATION | 1 |
| 1. ANTENNA CONNECTIONS | 2 |
| 2. POWER SWITCH | 2 |
| 3. PANEL OPERATION | 2 |
| 3.1 STANDBY BUTTON | 3 |
| 3.2 CHANNEL PRESET | 3 |
| 3.3 SKIP BUTTON | 4 |
| 3.4 CHANNEL SELECTION | 4 |
| 3.5 VOLUME CONTROL | 5 |
| 3.6 AV/TV SELECTOR | 5 |
| 3.7 TINT CONTROL | 5 |
| 4. REMOTE CONTROL OPERATION | 6 |
| 4.1 INSTALLING BATTERIES | 6 |
| 4.2 STANDBY BUTTON | 6 |
| 4.3 CHANNEL SELECTION | 7 |
| 4.4 SOUND CONTROL | 8 |
| 4.5 PICTURE CONTROL | 8 |
| 4.6 MAKING USE OF PPS BUTTON | 9 |
| 4.7 DISPLAY BUTTONS | 9 |
| 4.8 SLEEP BUTTON | 10 |
| 4.9 TIMER OPERATION | 10 |
| 4.10 SYSTEM SELECTION | 12 |
| 5. INTERFACES | 13 |
| 5.1 VIDEO PLAYBACK | 13 |
| 5.2 RECORDING FROM THE TV SET | 13 |
| 5.3 DUBBING | 14 |
| 6. TROUBLE SHOOTING GUIDE | 15 |
| 7. SPECIFICATIONS | 16 |

This equipment has been designed and manufactured to meet the highest international standards, but, like any electrical apparatus which is operated at mains voltage, care must be taken if you are to obtain the best results and safety is to be assured. This is particularly important with audio and TV equipment.

- DO read this handbook carefully and keep it handy for ready reference.
- DO ensure that all electrical connections (including the mains plug, extension leads and interconnections between pieces of equipment) are properly made and in accordance with the manufacturer's instructions. Check that the mains fuse rating is correct.
- DO always call in your dealer if you are ever in doubt about the installation, operation or safety of your equipment, he is the best person to advise you.
- DO unplug the power cord if the appliance is left unused.
- DON'T obstruct the necessary all round ventilation: moderate heat is generated when product is operating - ensure installation is clear of curtains etc. Do not obstruct cooling vents on rear of cabinet.

Remember that to obtain the best performance and lasting satisfaction from your equipment : -

have it regularly maintained by a reliable service organisation: ensure that it is correctly used by all the family.

■ ABOVE ALL:-

- Never let children push anything into holes or slots in the cabinet - this could result in an electric shock.
- Never guess or take chances with electrical equipment of any kind - it is better to be safe than sorry.

■ WARNING:

- To prevent fire or shock hazard do not expose this appliance to rain or moisture.
- No user serviceable parts inside. Refer servicing to qualified service personnel. Never remove covers unless qualified to do so; this unit contains dangerous voltages.

■ LOCATION:

- LOCATE appliance in the room where direct light does not strike the screen.
- ALLOW adequate space between the appliance and the wall to permit proper ventilation.
- AVOID excessive warm and dusty location to prevent possible damage to the cabinet and component failure.
- NEVER install the appliance in a strong magnetic field.
- CONNECT the appliance to AC 230 or 240 V, 50Hz outlet

1. ANTENNA CONNECTIONS

- 1.1 Optimum colour reception requires a good antenna. An out-door antenna will be more effective to obtain a clear-picture.
- 1.2 Insert the out-door antenna into the antenna socket on the cabinet back. Adjust the direction or position of the outdoor antenna for the best possible picture.

2. POWER SWITCH

- 2.1 Press the power switch when the power is off, the indicator (red) lights up, the screen is dark, the TV is in standby mode.
- 2.2 If you want to cut off the power completely, and do not-want to use On Timer function, press the Power Switch again to disconnect the set's power and confirm that the indicators go out.

3. PANEL OPERATION:

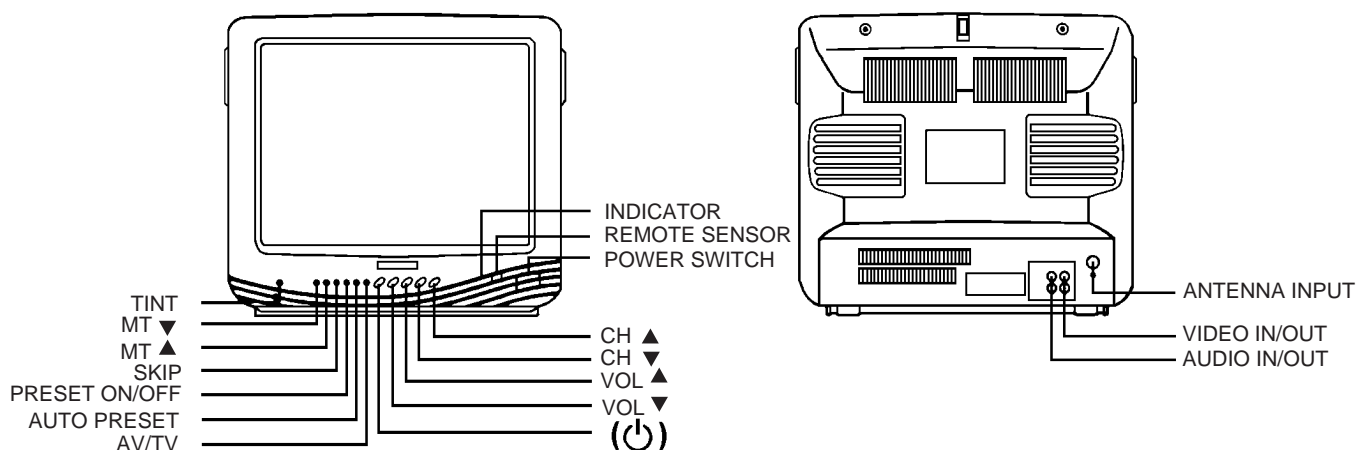

3.1 STANDBY (⏻) Button

3.1.1 Press STANDBY (⏻) button to turn on the set (the indicator shows yellow) when the set is in STANDBY mode (the indicator shows red) , the channel position number is displayed in the screen. Press STANDBY (⏻) button to return the set to the STANDBY mode when the set is in OPERATION mode, and the indicator shows red.

3.2 CHANNEL PRESET

3.2.1 AUTO PRESET

3.2.1.1 Press PRESET ON/OFF button to set PRESET mode. The current band and channel position will be displayed on screen. (In green)

3.2.1.2 Press AUTO PRESET button, the appliance will search for the signal of TV stations in the order of VHFL, VHFH and UHF as shown in the following and memorise them from channel number 1 position.

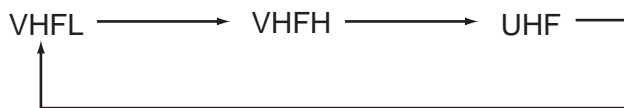

3.2.1.3 When presetting is over, the channel position is set to number 1 automatically.

3.2.1.4 Press PRESET ON/OFF button to exit preset mode.

NOTE: * During presetting, the green bar turns into yellow.

The moving bar indicates the change of tuning frequencies.

* During presetting, auto presetting will be cut off if any one of STAND BY button, PRESET ON/OFF button or AUTO PRESET button is pressed.

3.2.2 MANUAL TUNING

3.2.2.1 Press PRESET ON/OFF button to set preset mode.

3.2.2.2 Select a channel position.

If "SKIP" displays on the screen, press "SKIP" button to exit "SKIP" mode.

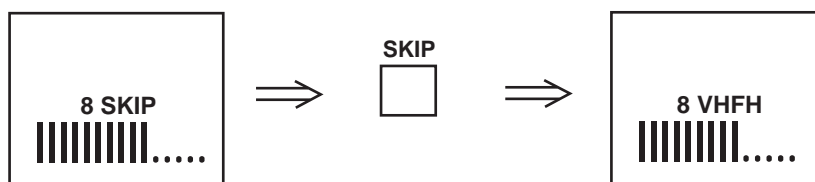

3.2.2.3 Press and hold MANUAL TUNING button until your desired program appears.

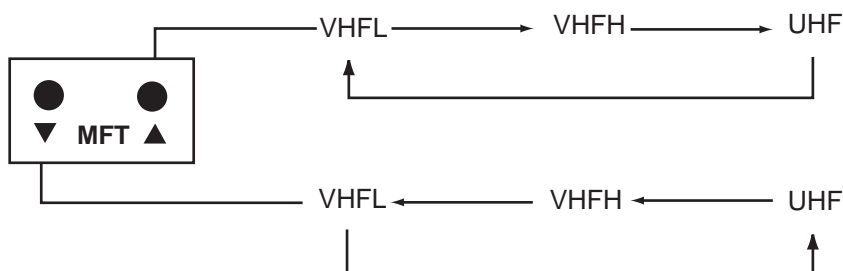

3.2.2.4 Press PRESET ON/OFF button to exit preset mode.

The searched program station has been memorised at the present channel position,

3.2.2.5 Repeat 1~ 4 steps to search another channel.

NOTE : * If the same channel position is selected during repeat operation, the former memory will be erased.

* If some channel position is tuned by MANUAL TUNING mode, AFC (automatic frequency control) function is defeated in this channel position.

3.3 SKIP BUTTON

3.3.1 FUNCTION

When CHANNEL SELECTOR (▲/▼)button is used to select channel, the channels will be skipped if they are set to "SKIP" mode. For example: Set 2~7 channels to "SKIP" mode, the procedure of channel position increasing or decreasing is as shown.

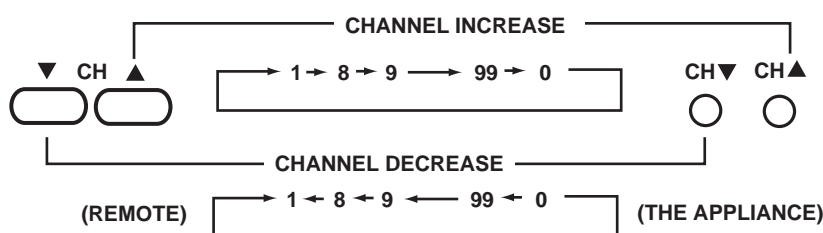

3.3.2 OPERATION:

3.3.2.1 Press PRESET ON/OFF button to set preset mode.

3.3.2.2 Select a channel by using CHANNEL SELECTOR button.

3.3.2.3 Press "SKIP" button, "SKIP" will be displayed on the screen to indicate that the channel is at "SKIP" mode.



3.3.2.4 Repeat 2~3 steps to skip another channel.

3.3.2.5 Press PRESET ON/OFF button to exit preset mode.

3.4 CHANNEL SELECTION

3.4.1 This set is preset to Australia channels 2, 7, 9, 10, 28 on those numbers. If you wish to change the settings, or add more channels the method is quite straight forward.

3.4.2 Press CHANNEL SELECTOR (▲/▼)on the appliance, the channel number will be increased or decreased as shown in the following Fig. , and displayed in the upper right corner of the screen.

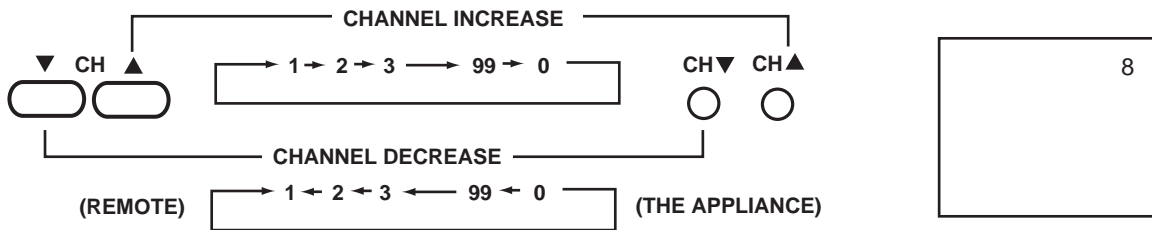

3.5 VOLUME CONTROL

3.5.1. Press the VOL▲ button to increase volume ; the green bar on the screen moves right.

3.5.2. Press the VOL▼ button to decrease volume ; the green bar on the screen moves left.

Display of minimum volume



Display of maximum volume



3.6 AV/TV SELECTOR

Press AV/TV button to change TV mode to AV mode when the set is in receiving (TV) mode. On the contrary, press it to change AV mode to TV mode when the set is in VIDEO mode.

3.7 TINT CONTROL

Use this knob to control colour tone during reception of pictures when using the NTSC system.

4. REMOTE CONTROL OPERATION:

REMOTE CONTROL UNIT

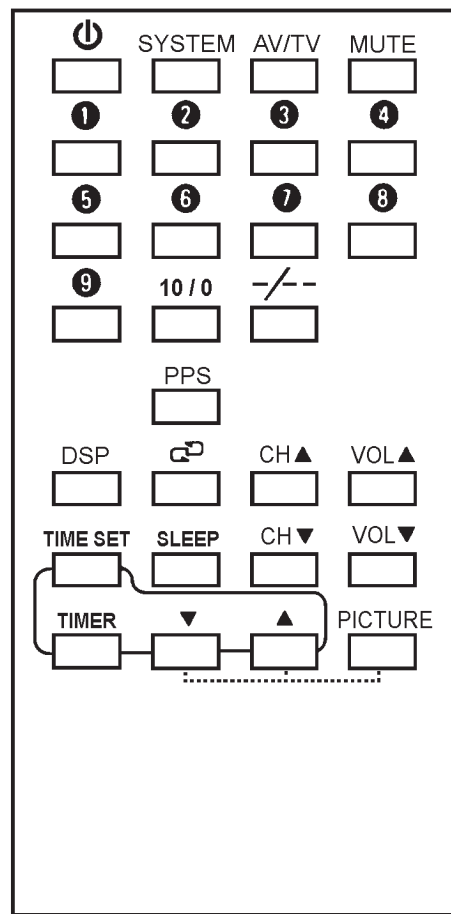

⏻ : STANDBY
 1 ~ 9 : DIGITAL CHANNEL SELECTOR
 10/0 : CHANNEL 10 OR CHANNEL 0 SELECTOR
 SYSTEM : COLOUR SYSTEM CONTROL
 -/- : DIGIT OR TWO DIGIT CHANNEL
 SELECT
 ⏪ : PREVIOUS

CH ▲/▼ : CHANNEL SELECTOR
 VOL ▲/▼ : VOLUME CONTROL
 PPS : PERSONAL PREFERENCE SELECT
 (BRIGHTNESS, COLOUR)
 ▲/▼ : PICTURE/TIME ADJUSTMENT
 PICTURE : PICTURE CONTROL
 DSP : DISPLAY

4.1 INSTALLING BATTERIES:

4.1.1 Remove the battery cover of Remote Control Unit.

4.1.2 Insert two "AAA", 1.5V batteries, making sure the polarity (+ or -) of the batteries matches the polarity marks inside the unit.

4.1.3 Close the battery cover

NOTE: * When the Remote Control Unit is not used for a long time or the batteries are worn out, take out the batteries to prevent electrolyte leakage.

* Take care not to drop, dampen, disassemble the Remote Control Unit.

4.2 STANDBY BUTTON

Refer to 3.1.

4.3 CHANNEL SELECTION

4.3.1 Press CHANNEL SELECTOR (▲/▼) the channel number will be increased or decreased and displayed in the upper right corner of the screen.

4.3.2 Use the DIGITAL CHANNEL SELECTOR button for direct channel selection.

1) 1~10 channel

Method 1:

Example:

To select channel 2

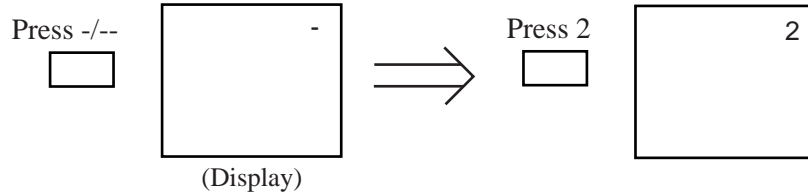

To select channel 10

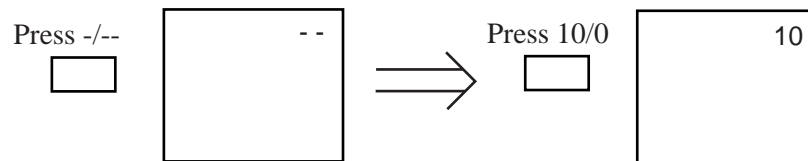

Method 2:

Example:

To select channel 2

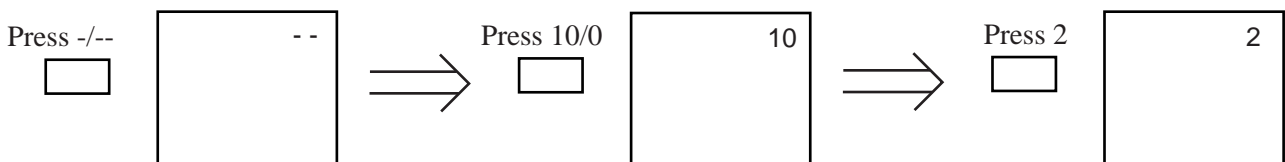

To select channel 10

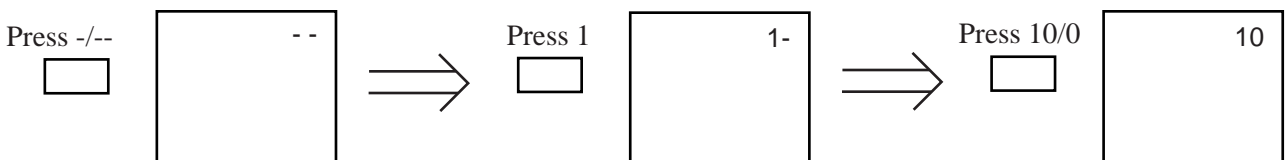

2) 11~99 channel

To select channel 28

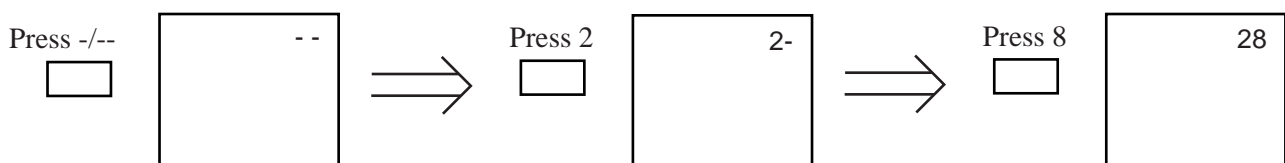

3) 0 channel

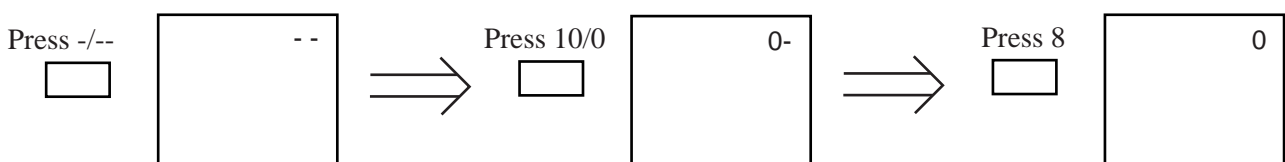

4.3.3 PREVIOUS BUTTON

Pressing this button to select the channel that was tuned immediately before the one being watched. For example: If you are watching the program on channel 6, and the previous programme you watched was on channel 15; then you can press the button to reach channel 15, press it again to return channel 6.

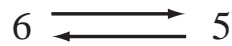

4.4 SOUND CONTROL

4.4.1 VOLUME CONTROL

4.4.1.1 Press the VOL ▲ button to increase volume; the green bar on the screen moves right.

4.4.1.2 Press the VOL ▼ button to decrease volume; the green bar on the screen moves left.

4.4.2 MUTE BUTTON

When there is a phone call or a visitor, it can temporarily shut off the sound without affecting the picture.

To resume normal, press the MUTE or VOLUME (▲/▼) button. The previous volume will be displayed for 4 seconds.

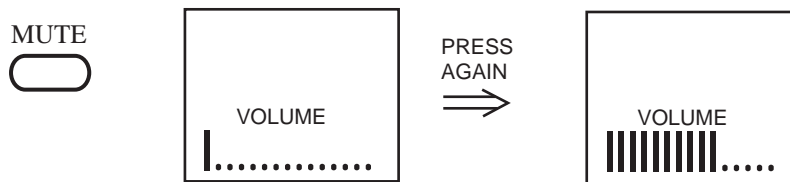

4.5 PICTURE CONTROL

4.5.1 Press the PICTURE CONTROL button on the Remote Control Unit.

The FUNCTION to be adjusted is selected in sequence as shown in the following chart at every press of the button.

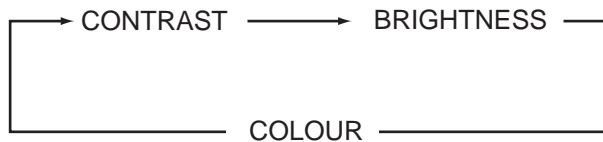

4.5.2 Adjust the ▲/▼ button to obtain satisfactory picture.

| | | | |
|--------------------------------------|------------|---------------------|----------------|
| ON SCREEN DISPLAY CAPTION DISPLAY | | Green Bar Moves | |
| | | Press ▼ button | Press ▲ button |
| FUNCTION | DISPLAY | | |
| Contrast | CONTRAST | Weak | Strong |
| Brightness | BRIGHTNESS | Dark | Light |
| Colour | COLOUR | Pale | Deep |

4.6 Making use of PPS button (personal preference select)

Press the PPS button, the screen will display the following five mode progressively:

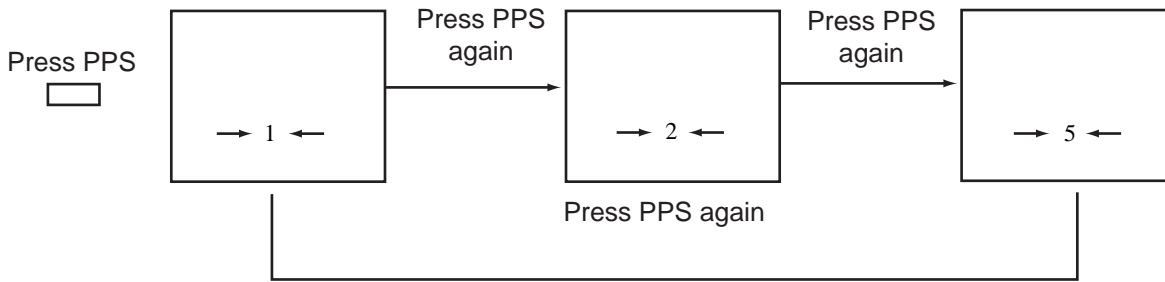

The above five display modes corresponding analogue quantity is shown in the following chart:

| Analogue Display mode | BRIGHTNESS | COLOUR | CONTRAST |
|-----------------------|------------|--------|----------|
| → 1 ← | | | |
| → 2 ← | | | |
| → 3 ← | | | |
| → 4 ← | | | |
| → 5 ← | | | |

4.7 DISPLAY BUTTON (DSP)

Press this button, the present channel number will be displayed on the screen. If the electronic clock is in operation, the channel position and time will be displayed together at the upper right corner of the screen. Press this button for second time, channel position and colour system will be displayed. Press this button for third time to cancel display.

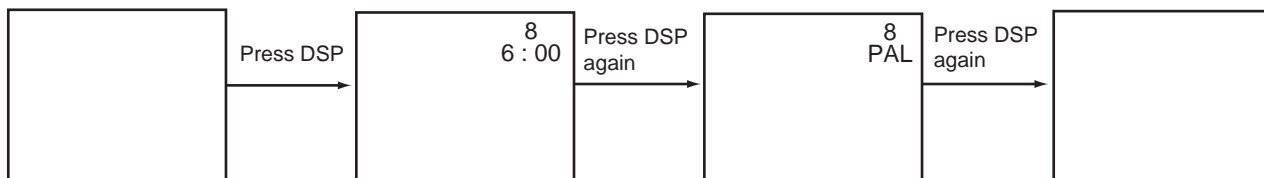

4.8 SLEEP BUTTON

4. 8. 1 Using SLEEP button allows you to have the appliance automatically turned off after a pre-determined time, and set the appliance to STAND BY mode.

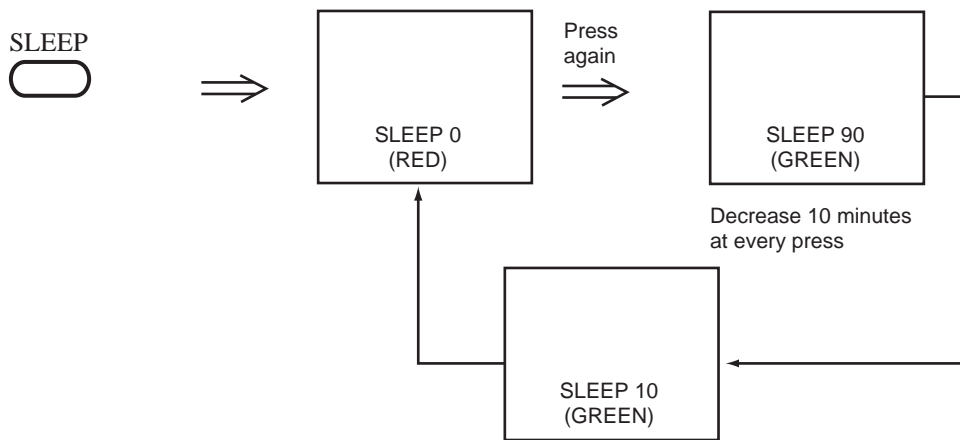

4. 8. 2 After the SLEEP function is set, the remaining time will be automatically displayed for 4 seconds every ten minutes.

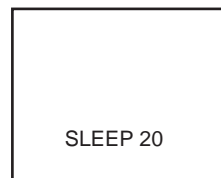

NOTE: * If you press STAND BY button while the SLEEP function is operating, the SLEEP function will be cancelled automatically.

* "SLEEP 0" indicates the set is in the SLEEP function-free mode.

4.9 TIMER OPERATION

Using TIMER button to select one of three timer modes, which are CLOCK mode, ON TIMER mode and OFF TIMER mode respectively.

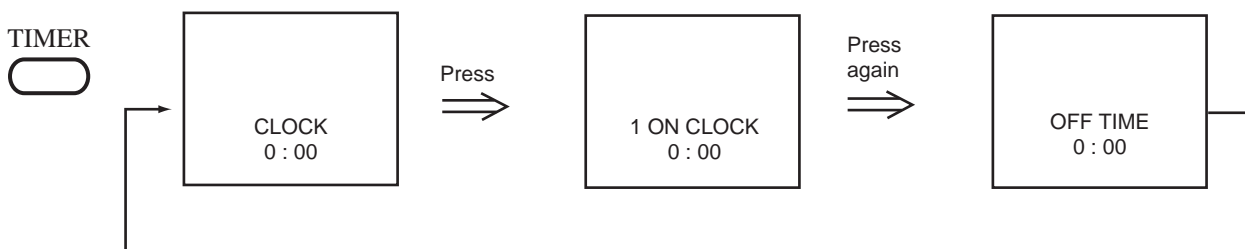

4.9.1 CLOCK

- 4.9.1.1 Press the TIMER button till "CLOCK" displays-on the screen.
- 4.9.1.2 Press the ▲ button to set the present hour.
Press the ▼ button to set the present minute.
- 4.9.1.3 After setting the clock, press TIME SET button to start operating. Now the indication on the screen is green instead of red.

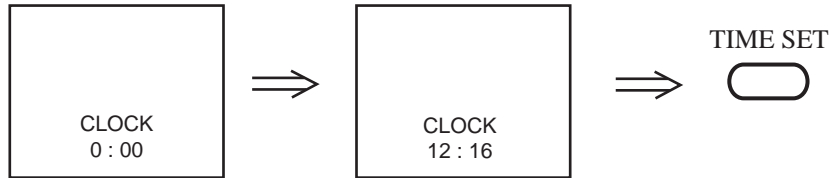

- 4.9.1.4 Use DSP (DISPLAY) button to display the present time on the screen.
See "DISPLAY BUTTON" operation.

NOTE: * The built-in clock employs the 24-hour system.
* In case of power failure, the clock operation will be cancelled. Clock displays 0:00 (red).

4.9.2 ON TIME OPERATION

- 4.9.2.1 Press the TIMER button till "ON TIME" displays on the screen.
- 4.9.2.2 Press ▲ button to select the exact hour when you want to turn on the appliance.
Press ▼ button to select the exact minute when you want to turn on the appliance.
- 4.9.2.3 Press the CHANNEL SELECTOR to set your desired channel.

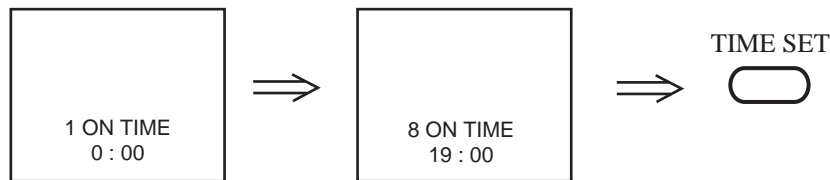

- 4.9.2.4 Press TIME SET button, the ON TIME indication is green instead of red. ON TIME function starts operating. Then press STAND BY button to set STAND BY mode.
- 4.9.2.5 The appliance will be turned on automatically when the clock reaches your setting time.

NOTE: * The ON TIME operation will be cancelled if you switch off the power before your setting time is up.
* If the TV set keeps on working after you have set the ON TIME function, the channel number will be changed to the setting one when 'the setting time is up.

4.9.3 OFF TIME

- 4.9.3.1 Press TIMER button till "OFF TIME" displays on the screen.
- 4.9.3.2 Press ▲ button to set the exact hour when you want to turn off the appliance.
Press ▼ button to set the exact minute when you want to turn off the appliance.

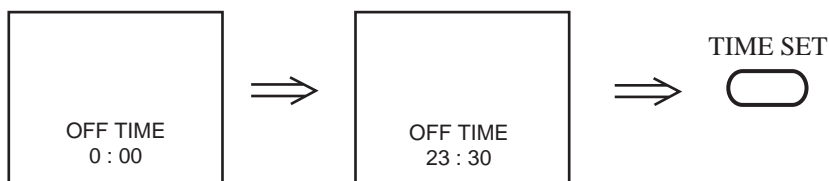

4.9.8.8 Press TIME SET button, then the OFF TIME indication is green instead of red.

OFF TIME function starts operating.

4.9.8.4 The appliance will be turned off when your setting time is up, and return to stand by mode.

NOTE: * The built-in clock employs the 24-hour system.

* The OFF TIME function will be ineffective if the following condition occurs:

Press STAND BY button before the setting time is up.

Switch off the power before the setting time is up.

4.10 SYSTEM SELECTION

4.10.1 FUNCTION AND OPERATION.

When you press the SYSTEM button, "AUTO" "PAL" "NTSC" will display on the screen respectively.

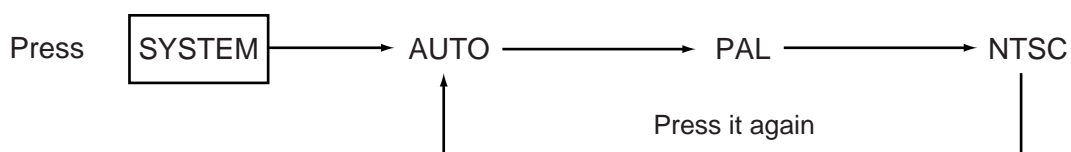

| SYSTEM OSD | COLOUR SYSTEM | Colour Sub-Carrier | Vertical Frequency |
|---------------|----------------------|--------------------|--------------------|
| AUTO | PAL-BG | 4.43MHz | 50Hz |
| | NTSC 3.58 only video | 3.58MHz | 60Hz |
| PAL | PAL-BG | 4.43MHz | 50Hz |
| | PAL 60 only video | 4.43MHz | 60Hz |
| NTSC | NTSC 4.43 only video | 4.43MHz | 60Hz |

4.10.2 Please set the "AUTO" mode by SYSTEM button normally when you watch TV broadcasting program (PAL-B/G) or NTSC 3.58 (video) program.

Please set "PAL" mode only when you watch PAL-60 program.

Please set "NTSC" mode only when you watch NTSC 4.43 program.

NOTE:

When you don't understand the system of the program, the picture may be no colour. At this time, press SYSTEM button to select the system until the colour picture displays on the screen.

5. INTERFACES

This set has Audio & Video input and output sockets which allow direct connection to external equipments for playing back and recording the programs.

5.1. VIDEO PLAYBACK

5.1.1 The figure below shows how to connect the TV set to the video equipment.

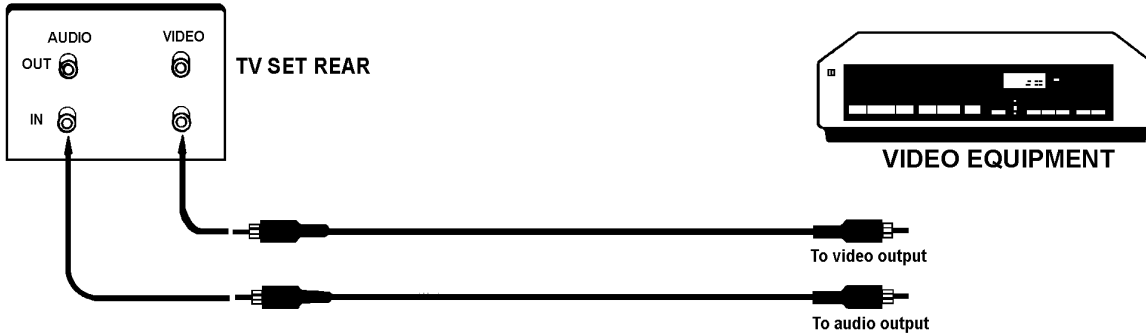

5.1.2 Press the AV/TV button on the TV set or on the remote controller to select VIDEO mode, "VIDEO" will be displayed on the screen. The picture shown on the screen is the program from the video equipment.

NOTE: The VCR signal can be input by antenna input socket of the TV set, but the quality of the picture and sound is not better than that of video mode.

5.2. RECORDING FROM THE TV SET

5.2.1 The figure below shows how to connect the TV set to the VCR.

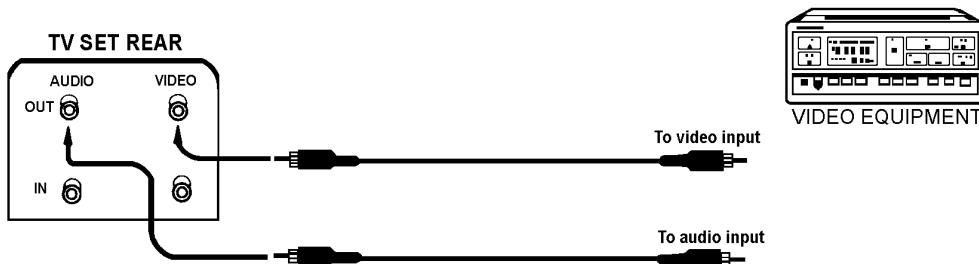

5. 2. 2 Press AV/TV button of the TV set or on the remote control unit to set the set to TV mode, and choose the desired channel.

Note: the following mis-operation should be avoided during recording.

- * Press STANDBY button or set to VIDEO mode.
- * Change the current channel accidentally.

5.3 DUBBING

5.3.1 The picture below shows how to connect TWO VCRs to the TV for dubbing one from the other.

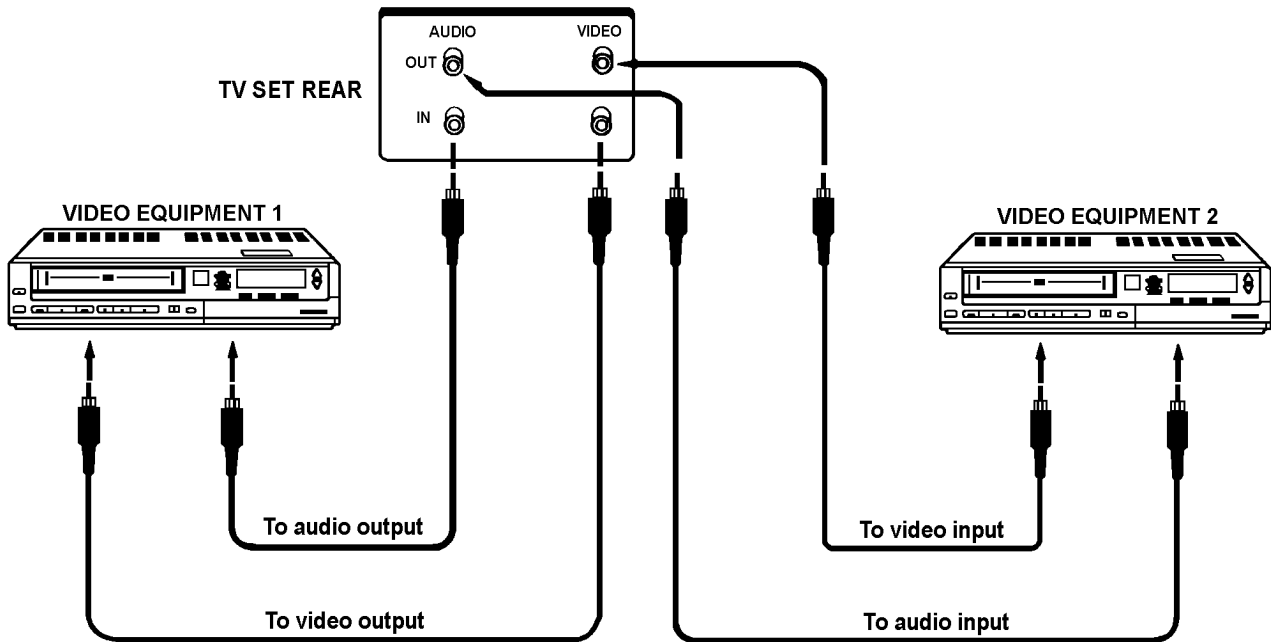

5.3.2 Press AV/TV button of the TV set or on the remote control unit to select Video mode before dubbing, "VIDEO" will be displayed on the screen. The TV set will act as a monitor to help you edit while dubbing.

NOTE: The set MUST remain in Video mode and MUST NOT be switched off during the session.

TROUBLE SHOOTING

Many apparent malfunctions may be caused by slight misadjustment of regular controls or some other equally similar simple causes. If any problem arises in the operation of your set, first check through this list of symptoms and correction. Should the problem be unsettled, unplug the set and contact your dealer.

| Symptoms | Check these things | Try these adjustment |
|--|--|---|
| <ul style="list-style-type: none"> No picture, no sound. | <ul style="list-style-type: none"> Be sure power cord is plugged in. May be station trouble. Check antenna connections. Maybe in AV mode. | <ul style="list-style-type: none"> Press POWER BUTTON Try another channel. Press AV button once. |
| <ul style="list-style-type: none"> Poor sound, picture OK. | <ul style="list-style-type: none"> May be station trouble. May be local interference from another appliance. Check antenna connections. | <ul style="list-style-type: none"> Try another channel. Reorient antenna. Adjust VOLUME control. |
| <ul style="list-style-type: none"> Poor picture, sound OK. Snowy picture Lines in picture Distorted picture Weak picture. | <ul style="list-style-type: none"> May be station trouble. Check antenna connections. Check antenna for broken wires. May be local interference from another appliance. | <ul style="list-style-type: none"> Try another channel. Reorient antenna. Adjust BRIGHTNESS control. Adjust CONTRAST control. |
| <ul style="list-style-type: none"> Multiple images (Ghost) | <ul style="list-style-type: none"> May be station trouble. Check antenna connections. May be local interference. | <ul style="list-style-type: none"> Try another channel. Reorient antenna. |
| <ul style="list-style-type: none"> Poor colour or no colour | <ul style="list-style-type: none"> May be station trouble. Check antenna connections. Check antenna for broken wires. May be local interference from another appliance. | <ul style="list-style-type: none"> Try another channel. Reorient antenna. Adjust COLOUR control. |
| <ul style="list-style-type: none"> Remote control does not work. | <ul style="list-style-type: none"> Be sure power cord is plugged in Check battery in Remote Control Hand Unit. | <ul style="list-style-type: none"> Change batteries. |
| <ul style="list-style-type: none"> No picture, Sound OK. | <ul style="list-style-type: none"> Station may be in trouble. | <ul style="list-style-type: none"> Try another channel. Switch off for several minutes the switch on. |
| <ul style="list-style-type: none"> TV cabinet creaks | <ul style="list-style-type: none"> Even if the picture or sound is normal, changes in the room temperature sometimes makes the TV cabinet expand or contract, making a noise. This does not indicate a malfunction. | |

7. SPECIFICATIONS:

| | |
|---------------------|--------------------------------------|
| TV System: | : PAL, B/G; NTSC 3.58/4.43 PLAYBACK |
| Receiver Channel | : VHFL 0-5, 5A; VHFH 6-11; UHF 21-69 |
| Power supply | : AC 240V, 50Hz |
| CRT | : 34cm |
| Antenna Impedance | : VHF/CATV/UHF 75 ohm |
| Dimension (mm) | : 366(W) x 333(H) x 373(D) |
| Weight | : 12kg |
| Power Consumption | : 60W |
| Remote Control Unit | |
| Power Supply | : DC 3V (AAA) |

* Design and specifications are subject to change without notice.

PALSONIC CORPORATION PTY LTD
1 JOYNTON AVENUE
WATERLOO NSW 2017 AUSTRALIA
TEL:(02)9313 7111
FAX:(02)9313 7555
www.palsonic.com.au

**PALSONIC CUSTOMER SERVICE
TELEPHONE
AUSTRALIA: 1300 657 888**

604-37F03-02

Free Manuals Download Website

<http://myh66.com>

<http://usermanuals.us>

<http://www.somanuals.com>

<http://www.4manuals.cc>

<http://www.manual-lib.com>

<http://www.404manual.com>

<http://www.luxmanual.com>

<http://aubethermostatmanual.com>

Golf course search by state

<http://golfingnear.com>

Email search by domain

<http://emailbydomain.com>

Auto manuals search

<http://auto.somanuals.com>

TV manuals search

<http://tv.somanuals.com>