

OWNER'S MANUAL

Palsonic

51CM CORDLESS REMOTE COLOUR TELEVISION
MODEL: 5160G



Type Tested
Electrical
Safety

AS/NZS 3250 Lic 4164
Standards Australia
APP No: N15959

PALSONIC CORPORATION PTY LTD
1 JOYNTON AVENUE
WATERLOO NSW 2017 AUSTRALIA
TEL:(02)9313 7111
FAX:(02)9313 7555
www.palsonic.com.au

**PALSONIC CUSTOMER SERVICE
TELEPHONE
AUSTRALIA:1300 657 888**

Contents

Contents

Congratulations on your purchase of this **Palsonic** colour television receiver. We recommend that you thoroughly read this manual before use to fully enjoy the many functions and excellent effects of this receiver.

Retain this manual in an easily accessible location for future reference.

Note: Screen displays and illustrations in this manual may differ from the actual ones for better visibility.

CONTENTS

Features	1
Important Safety Cautions	2
Identification of Controls	4
Front	4
Back	5
Remote controller	6
Installing batteries	7
Effective range of the remote	7
Installation	8
Antenna installation	8
Connect to video and audio equipment	9
Turning On/Off	10
Select Input Signal	11
Tuning In	12
Auto search	12
Manual search	12
Skip an unnecessary channel	13
Fine tuning	13
Setting colour system	14

Contents (continued)

Contents

Channel Selection	15
Adjusting Picture	16
Sound Control	17
Clock Setting	18
Setting Sleep Timer	18
Setting Timer	18
Setting Time Off	18
Setting Time On	19
Setting Alarm Channel	19
System Setting	20
Selecting OSD language	20
Calendar setting	20
Hotel mode	20
Child lock	21
Playing game	21
Troubleshooting Guide	22
Specifications	23

- ▶ **Hyperband**
- ▶ **TV System: PAL B/G, NTSC Playback**
- ▶ **255 preset channels**
- ▶ **Automatic channel preset**
- ▶ **Full function remote control**
- ▶ **English/French/Spanish/Indonesian on-screen display**
- ▶ **AV input & S-VIDEO input terminals**
- ▶ **Clock/Game/Calendar**
- ▶ **Digital AFT technology**
- ▶ **Four picture modes**
- ▶ **ON timer/OFF timer**
- ▶ **Green Power**
- ▶ **Hotel lock**

Important Safety Cautions

Safety Cautions

- 1 When any unusual situation occurs, turn off the power supply at once and remove the plug from the wall outlet. Contact a qualified service department in your local area.

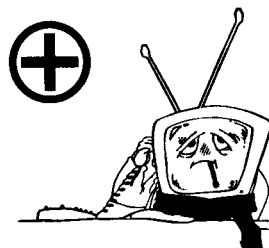

- 2 Do not expose the TV set to rain or excessive moisture. Avoid using the set in very warm or damp places and never use it in a bathroom.

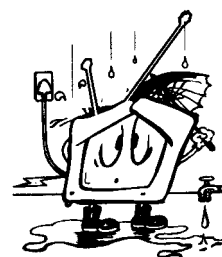

- 3 When cleaning dust off the picture tube disconnect the power first. You can wipe lightly with a piece of dry, clean and soft cloth.

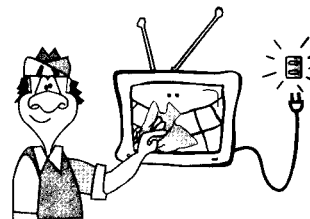

- 4 Avoid exposing the set to direct sunlight and other sources of heat to prevent damage to the cabinet and components.

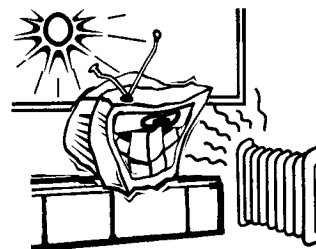

- ⚠ This TV set can operate on an AC power of 240V, 50HZ. You must not use a power supply of any other type.

- 5 High voltage exists in this TV set. Do not remove the cover

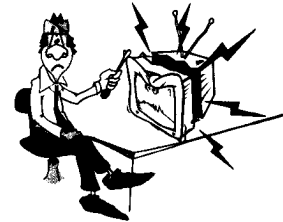

- 6 Do not cover the ventilating hole in the cabinet. Keep a space of more than 5cm from the walls to the TV set to ensure adequate ventilation.

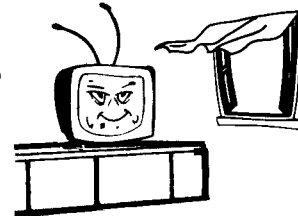

- 7 If the power cord or the plug is damaged contact a qualified service department for service.

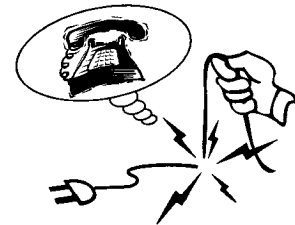

- 8 When the TV set is to be left unattended for a long period of time, turn off the power supply and remove the plug from the wall outlet.

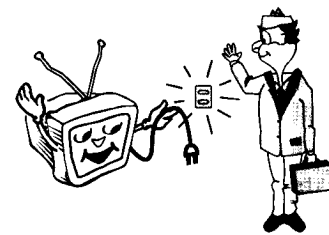

Identification of Controls

Front/Back view

Front

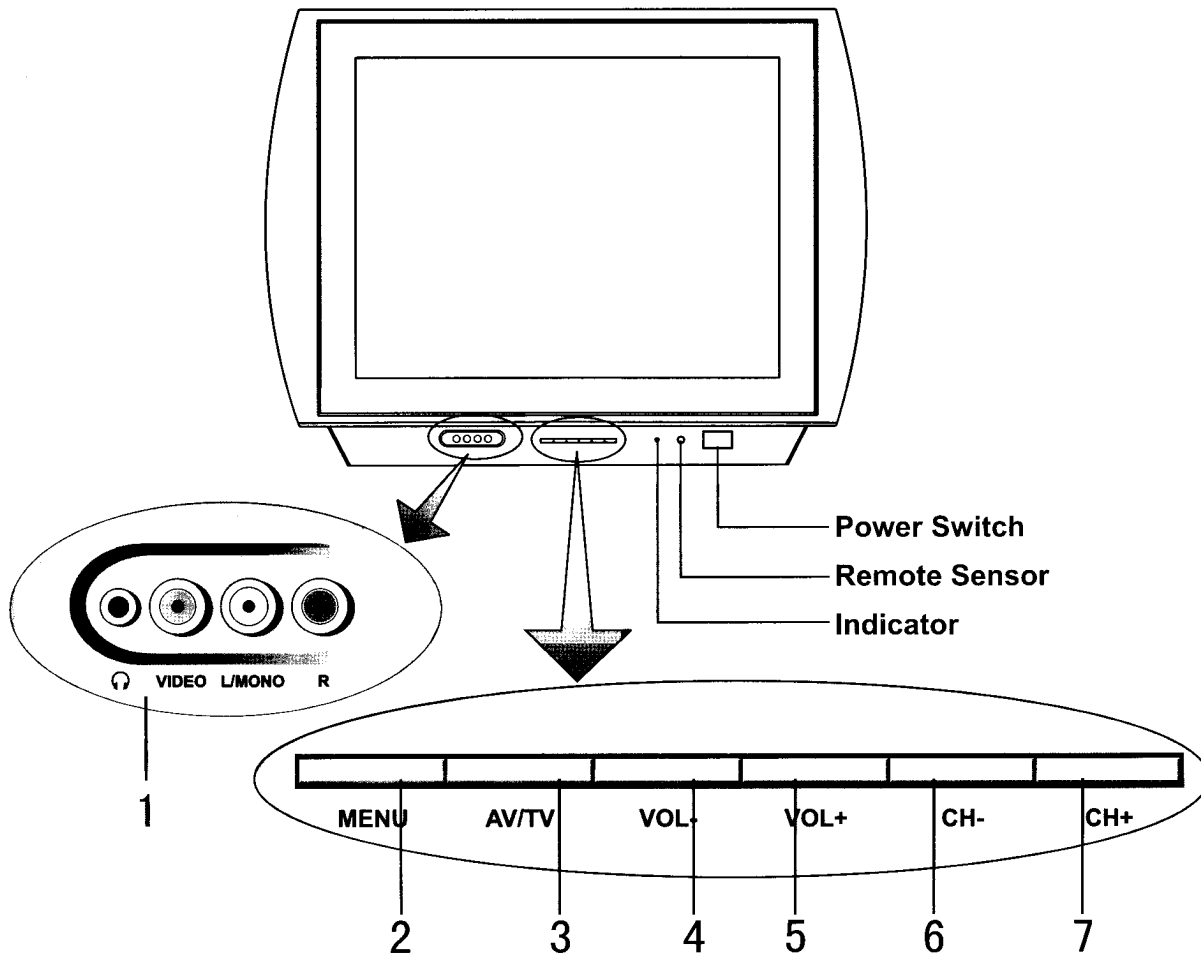

1. Earphone Jack

AV input terminals (VIDEO, AUDIO L/MONO, R)

2. MENU button: To enter into menu operation.

3. AV/TV button: Video input select.

4. VOL- button: volume down adjust; menu item adjust.

5. VOL+ button: volume up adjust; menu item adjust.

6. CH- button: channel down select; menu item select.

7. CH+ button: channel up select; menu item select.

Back

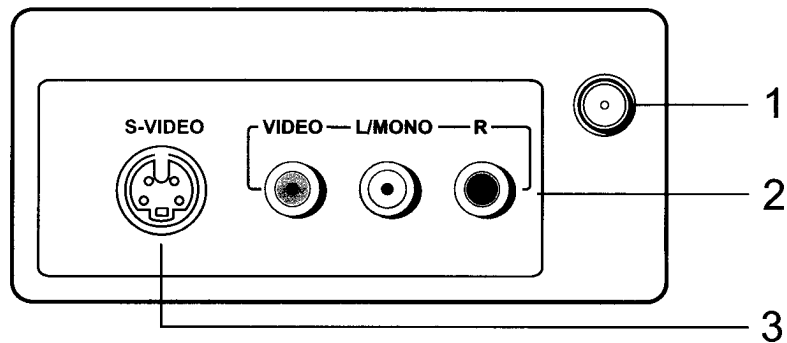
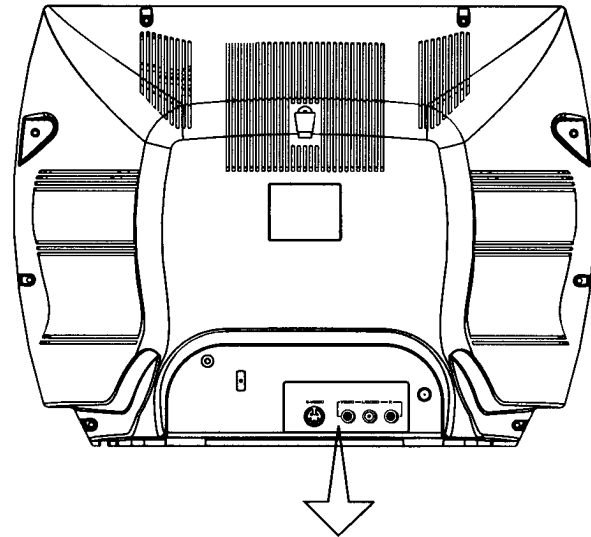

- 1. Antenna input
- 2. AV input (VIDEO, AUDIO L/MONO, R)
- 3. S-VIDEO input

Identification of Controls (continued)

Remote Controller

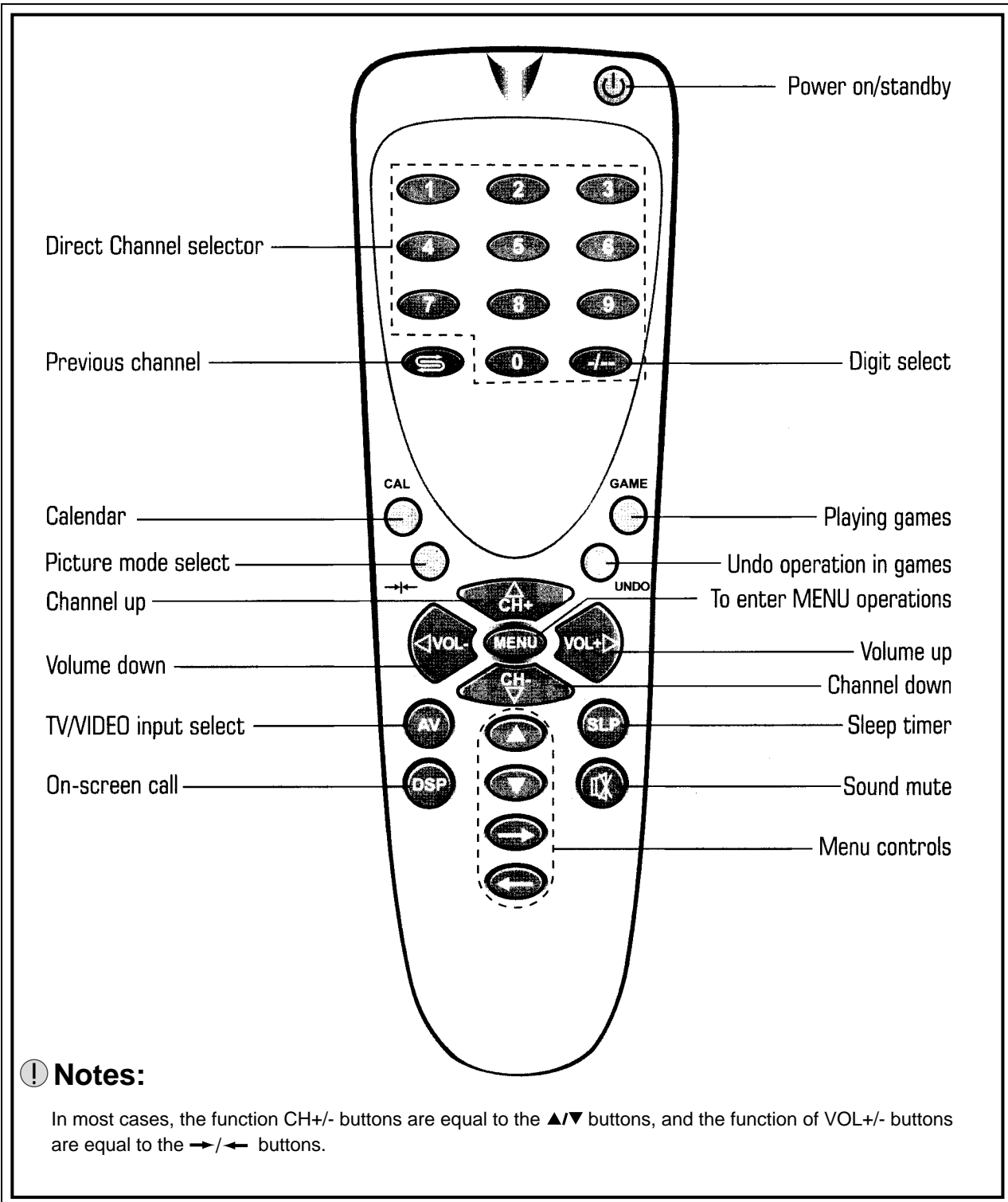

Installing batteries

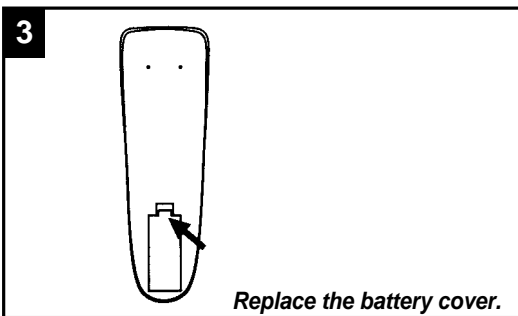
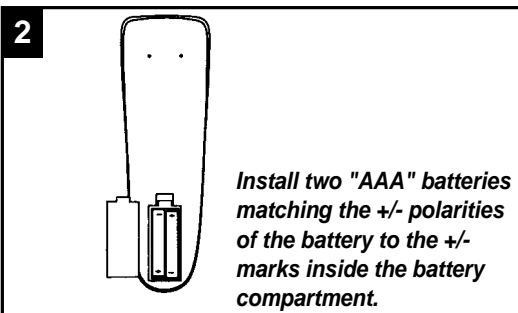
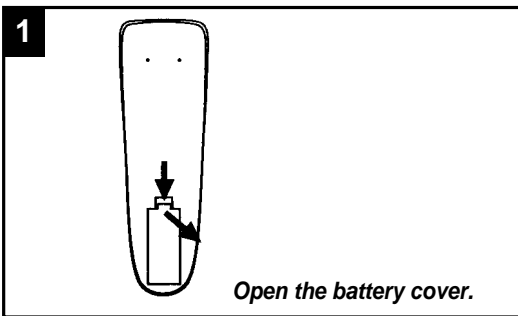

! Notes:

- ▣ The battery life should be about one year under normal use. Do not try to recharge batteries not intended to be recharged.
- ▣ Use only the size and type of batteries specified. Do not mix different types of batteries together or old batteries with fresh ones.
- ▣ When the remote control will not be used for a long period of time or when the batteries are worn out, remove the batteries.
- ▣ Do not throw the batteries into a fire. Dispose of used batteries in the specified manner.
- ▣ Do not drop, dampen or disassemble the remote control.

Effective range of the Remote

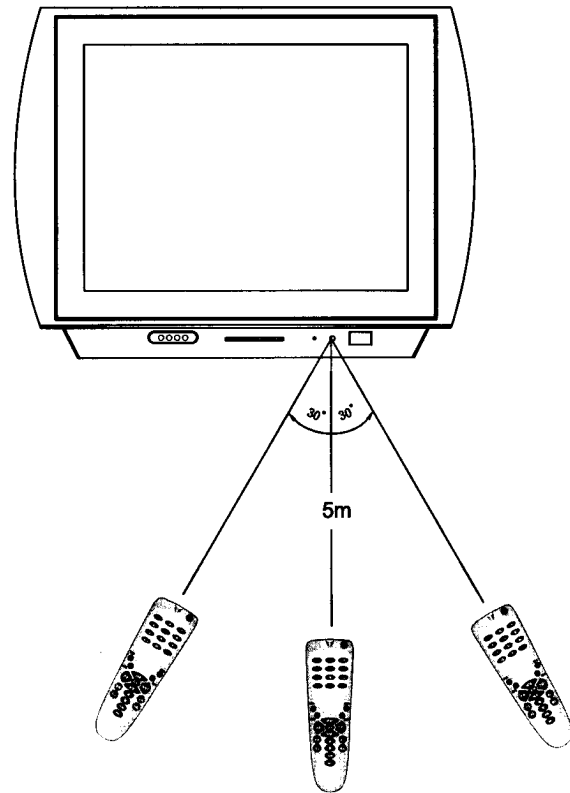

! Notes:

- ▣ When there is an obstacle between the TV and the transmitter, the transmitter may not operate.
- ▣ When direct sunlight, and incandescent lamp, fluorescent lamp or any other strong light shines on the REMOTE SENSOR of the TV the remote operation may be unstable.

Installation

INSTALL the unit in a room where direct light will not fall upon the screen. Total darkness or a reflection on the picture screen may cause eyestrain. Soft and indirect lighting is recommended for comfortable viewing.

Antenna Installation/Connect to video and audio equipment

Antenna installation

Optimum reception of colour requires a good signal and will generally mean that an outdoor aerial must be used. The exact type and position of the aerial will depend upon your particular area.

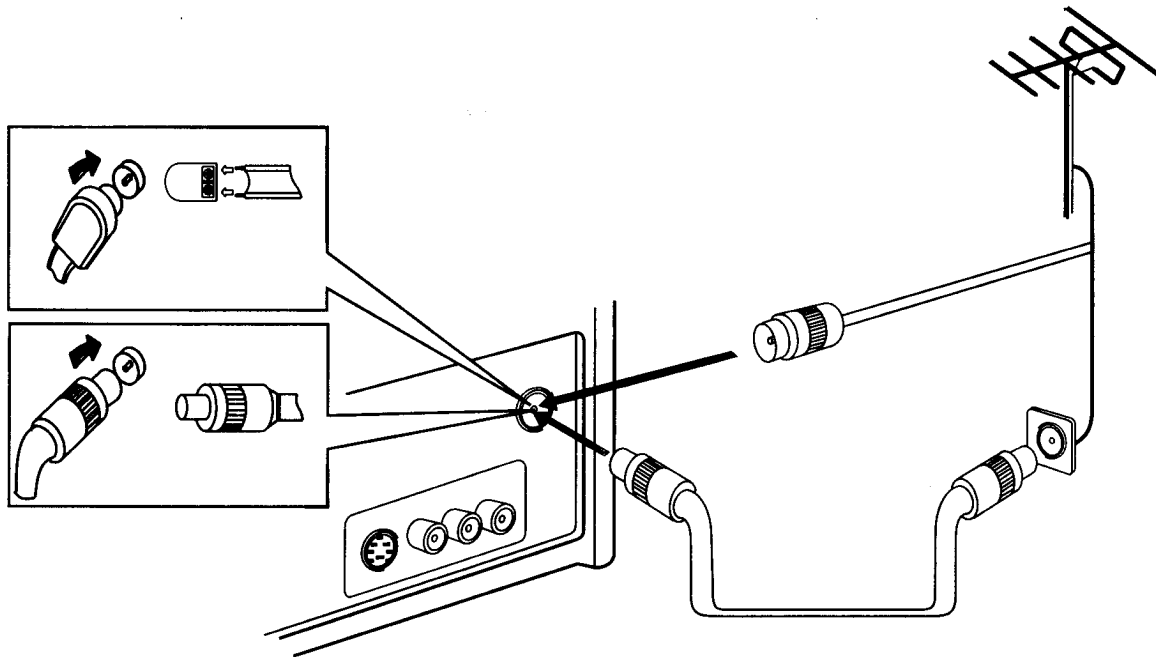

! Notes:

- It is recommended that the 75-ohm coaxial cable be used to eliminate interference and noise which may occur due to radio wave conditions.
- The aerial cable should not be bundled with the power cord and the like.

Connect to video and audio equipment

This TV set provides 2 groups of AV input terminals for your convenient connection to VTR, DVD or video camera to enjoy the high quality picture. Please refer to the owner's manual of the equipment to be connected as well.

Important notes on the AV input terminals

Please do not connect and use the front and rear input terminals at the same time.

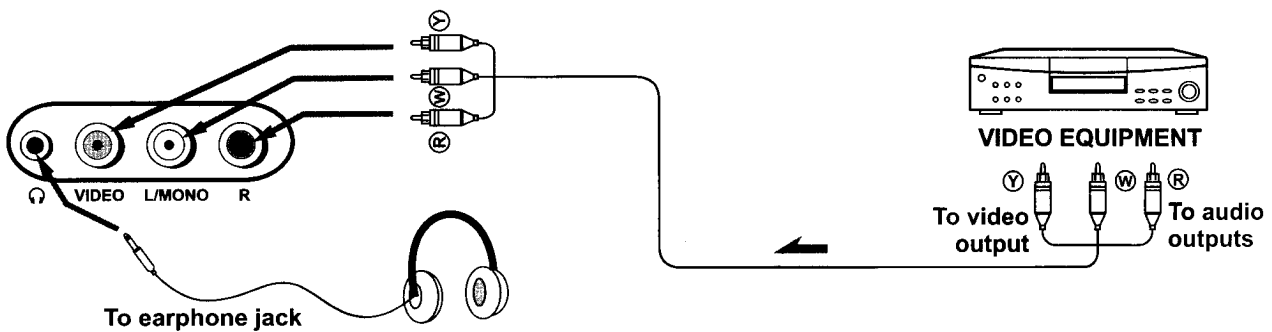

You can also use the AV terminals on the TV set rear as follows.

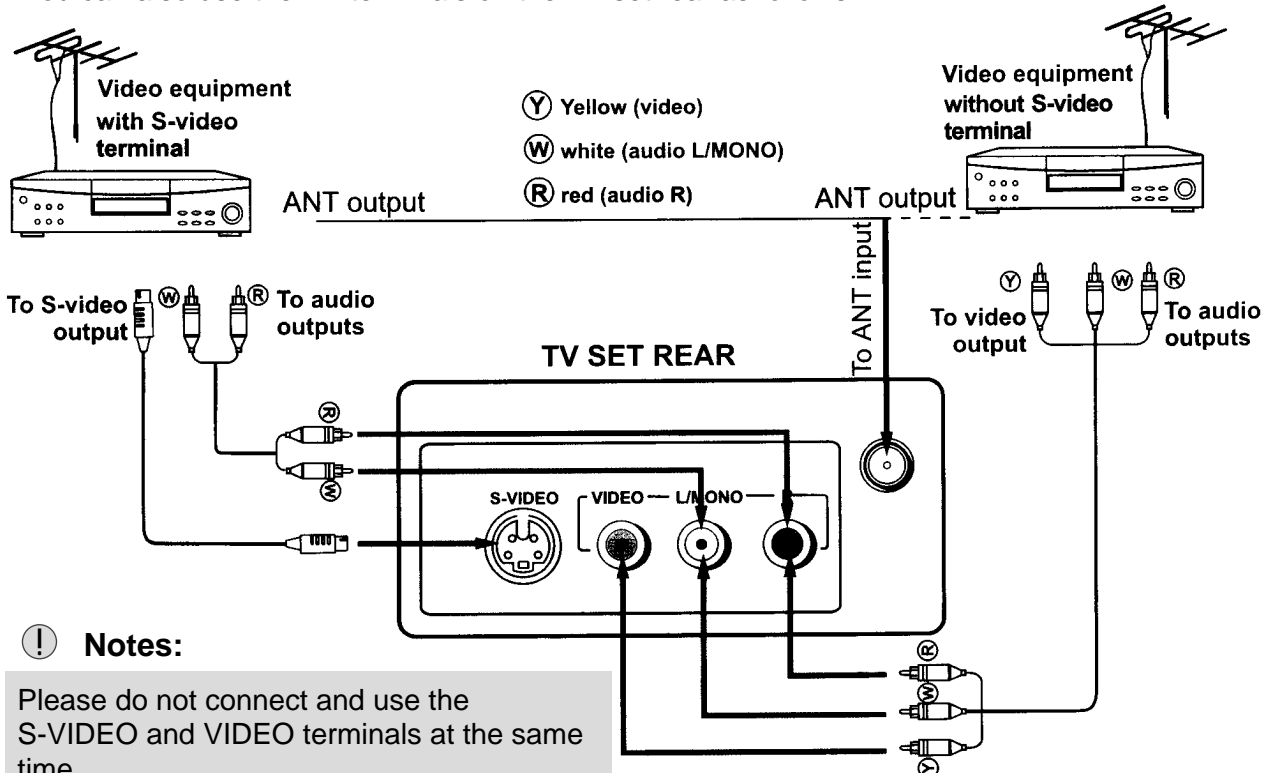

Notes:

Please do not connect and use the S-VIDEO and VIDEO terminals at the same time. Please note that the rear audio input terminals are stereo while the front are mono.

Turning on/off

Turning on/off

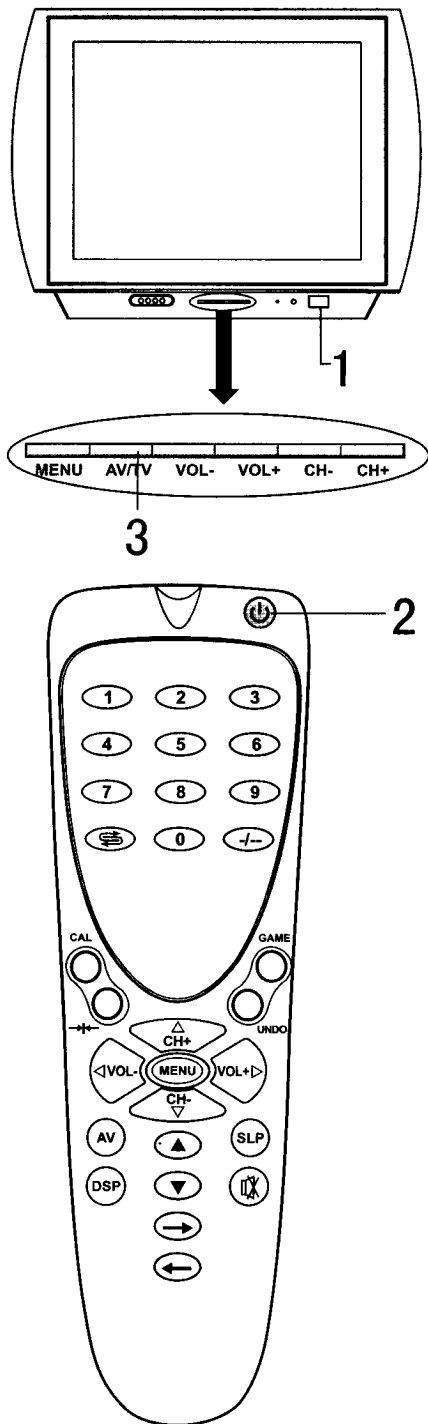

Turning on

- 1 Press the Power Switch on the TV set.**
If no picture appears, then the TV set is in STANDBY mode. Now please follow step 2.
- 2 In STANDBY mode, press the  button on the remote controller and the TV set is turned on.**
- 3 In STANDBY mode, you can also press the AV/TV button on the set to turn on.**

Notes:

If there is no input signal, then a blueback appears. After 15 minutes, the set auto goes to STANDBY.

Turning off

- 1 Press the Power Switch on the TV set if you want to cut off the power completely.**
- 2 If you want to turn off the TV set temporarily, press the  button on the remote controller.**

Select Input Signal

Select input signal

Select input signal

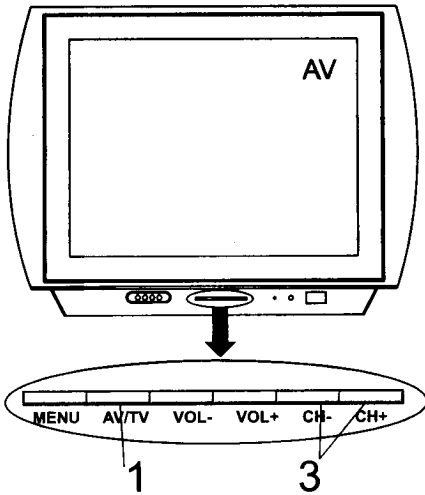

- 1 Press AV/TV button on the TV set or AV button on the remote control.**

When the set is in TV mode, press this button and the set goes to AV mode. Now you could watch video program from AV input terminals.

If you want to switch to TV press AV button again or follow step 2, 3 or 4.

- 2 Press digit buttons to switch back to TV mode.**

- 3 Press CH+ or CH- button to switch back to TV mode.**

- 4 Press  button to switch back to TV mode.**

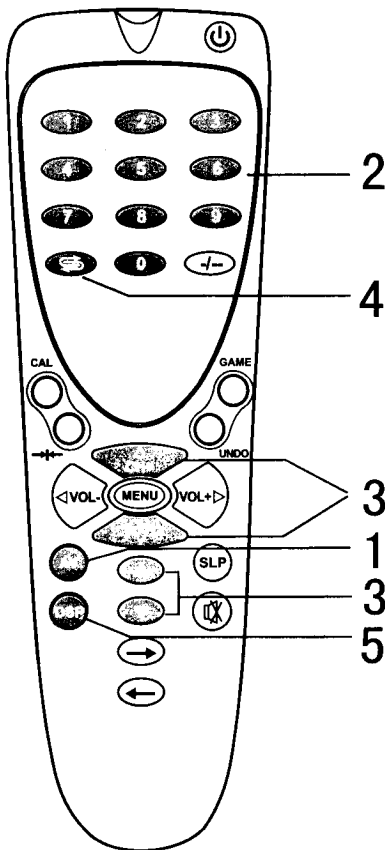

- 5 Press DSP button, the set displays current input mode.**

The OSD disappears in about 5 seconds.

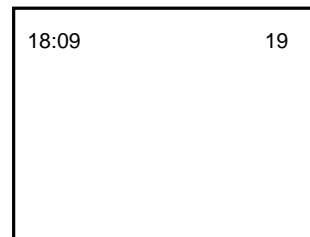

! Notes:

If the Timer item has been set, the current time also appears.

Tuning in

- 1 Press MENU button four times to call Program menu page.
- 2 Press CH+ or CH- buttons to select item.
- 3 Press VOL+ or VOL- buttons to adjust item.

Auto search/Manual search/Channel skip/Fine tuning

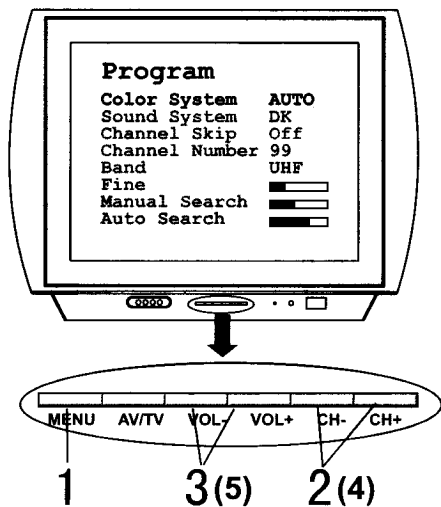

Auto Search

- 1 Press MENU button repeatedly to enter into Program menu page.
- 2 Press CH+ or CH- button repeatedly to select Auto Search item.
- 3 Press VOL+ button to start Auto Search towards higher frequency; or press VOL- button to start Auto Search towards lower frequency.

All active channels will be preset and stored into the memory automatically. After presetting, the TV will stop at the last channel program.

Notes:

1. Before you start Auto Search, we strongly recommend you to set a proper Sound System according to your local area. Please refer to the steps of Sound System setting on page 14.
2. During the process of AUTO SEARCH, pressing the MENU or CH+/- buttons will stop the process.

Manual Search

Use MANUAL SEARCH function if desired channels cannot be preset or if you would like to preset channels to specific position numbers one by one.

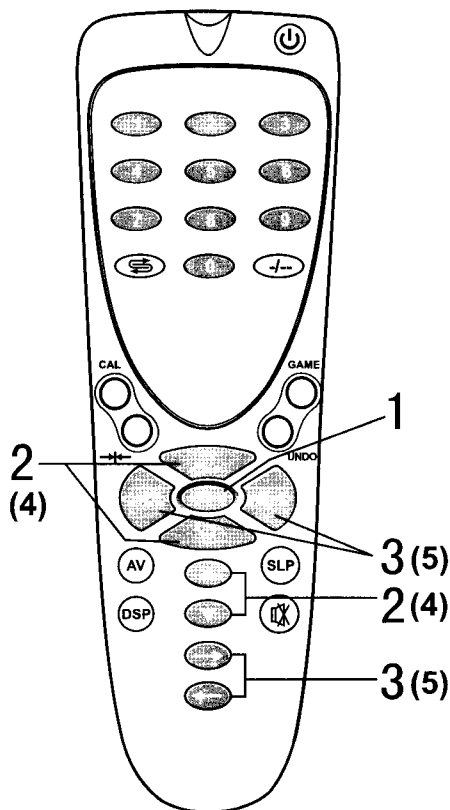

- 1 Press MENU button repeatedly to enter into Program menu page.
- 2 Press CH+ or CH- button repeatedly to select Channel Number item.
- 3 Press VOL+ or VOL- button to select a channel number (ranging from 0-254).
- 4 Press CH+ or CH- button repeatedly to select Manual Search item.
- 5 Press VOL+ or VOL- button to start program search manually.

Pressing VOL+ the set searches towards higher frequency; Pressing VOL-, the set searches towards lower frequency; The search stops when a program found and this program will be stored in the specified position number.

Notes:

1. The skipped channels can not be selected by VOL+/- buttons in step 3, then you should use digit buttons to select the skipped channels first and execute steps 1, 4 and 5 above.
2. You can use Band selection to quicken search process if you know which band your desired program locates in. The band switches among VHF-L, VHF-H and UHF.
3. Repeat the above steps if you want to store another program in other position number.

Channel Skip/Fine tuning

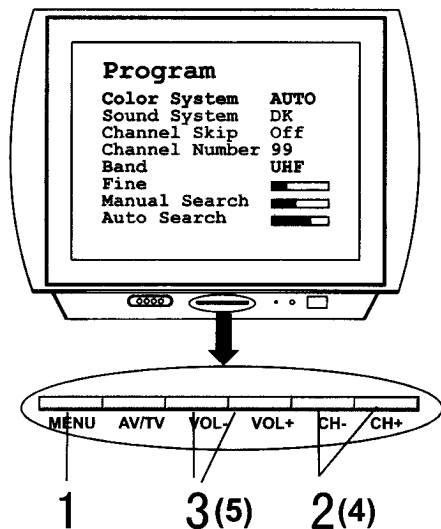

Skip an unnecessary channel

- 1** Press MENU button repeatedly to enter into Program menu page.
- 2** Press CH+ or CH- button repeatedly to select Channel Number item.
- 3** Press VOL+ or VOL- button to set a channel number (for example, channel 99).
- 4** Press CH+ or CH- button repeatedly to select Channel Skip.
- 5** Press VOL+ or VOL- button to set to On.

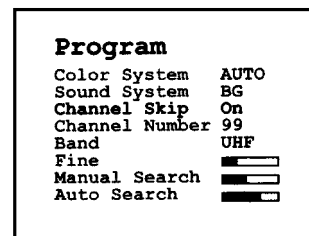

Now channel 99 will be skipped when you browse channels by CH+ or CH- button.

To restore a skipped channel, please use digit buttons to select the skipped channel, then repeat the above steps 1, 4 and 5 and set the Channel Skip item to Off.

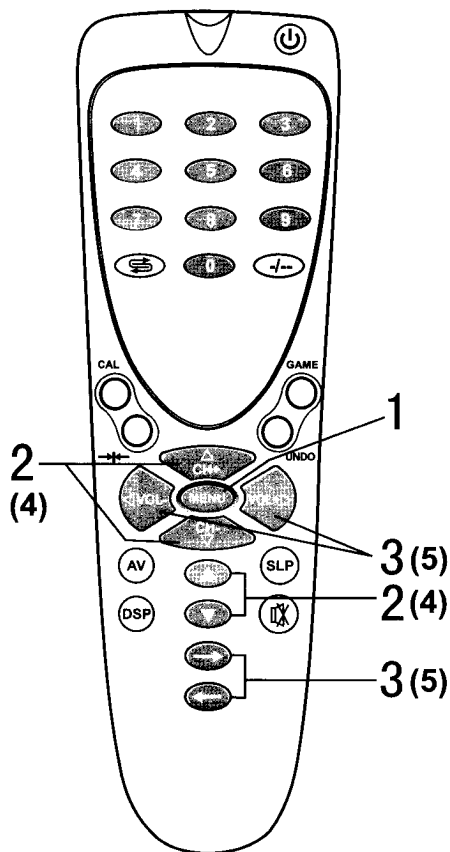

Fine tuning

Fine tuning is not necessary under normal conditions. However, in area of inferior broadcast conditions where adjustment is necessary for a better picture and sound, use Fine tuning.

- 1** Press MENU button repeatedly to enter into Program menu page.
- 2** Press CH+ or CH- button repeatedly to select Channel Number item.
- 3** Press VOL+ or VOL- button to set a channel number you want to fine-tune (for example, channel 99).
- 4** Press CH+ or CH- button repeatedly to select Fine.
- 5** Press and hold VOL+ or VOL- button till the best possible picture and sound are obtained.

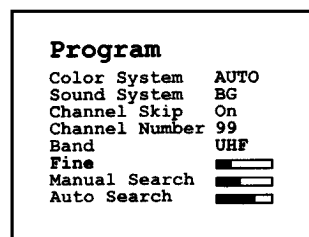

Tuning in (Continued)

Colour System/Sound System Selection

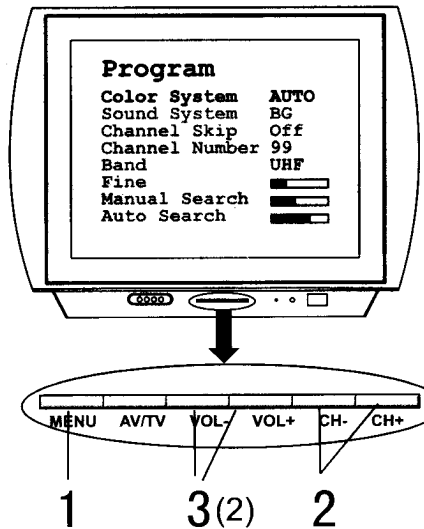

Setting Colour System

If the picture colour is abnormal, maybe the colour system setting is wrong. Then you can select a proper colour system as follows.

- 1 Press MENU button repeatedly to enter into Program menu page.
- 2 Press VOL+ or VOL- button to select a proper colour system.

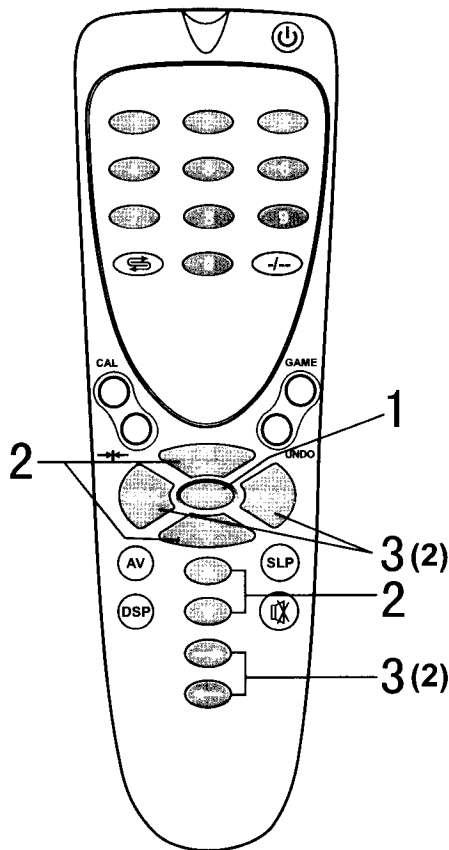
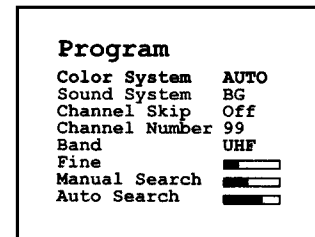

Setting Sound System

If the sound is abnormal, maybe the sound system setting is wrong. Then you can select a proper sound system as follows.

- 1 Press MENU button repeatedly to enter into Program menu page.
- 2 Press CH- button to select Sound System item.
- 3 Press VOL+ or VOL- button to select a proper sound system.

Some models are with only one sound system and in this case the Sound System does not need to be adjusted.

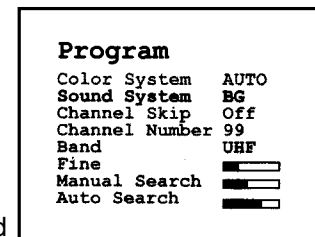

! Notes:

When the set is in AV mode, only Colour System appears in Program menu page.

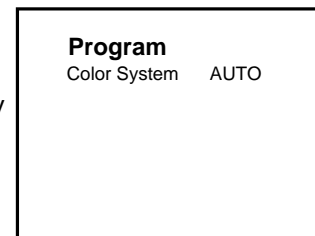

Channel Selection

Channel Selection

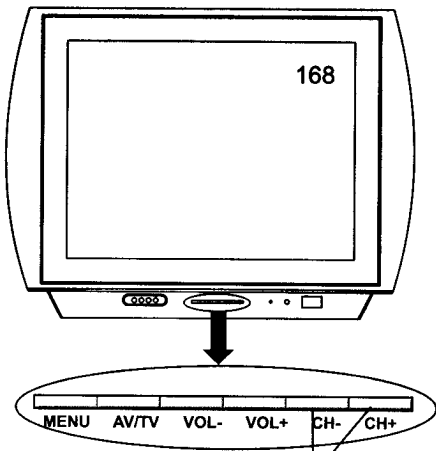

2

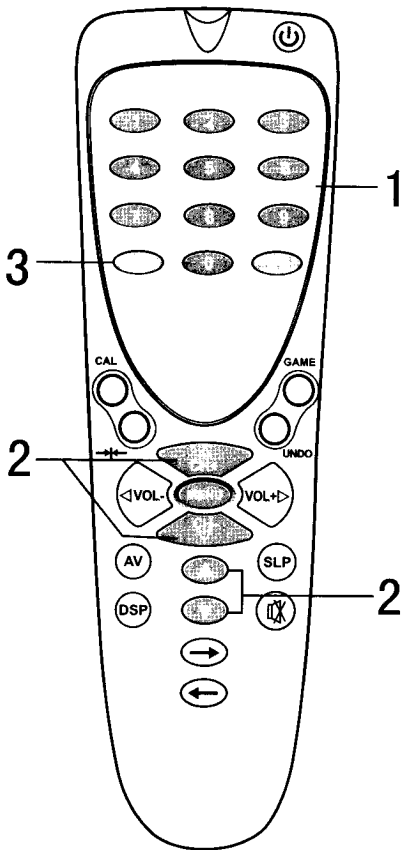

1 Use Direct Channel Selector (0-9 and -/-- buttons)

To select one-digit channel:

Press -/-- button repeatedly to display "--".

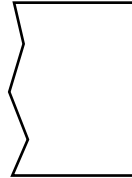

Press 0-9 direct channel selector.

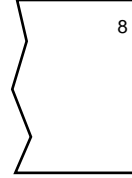

To select two-digit channel:

Press -/-- button repeatedly to display "--".



Press 1-9 buttons.



Press 0-9 buttons.

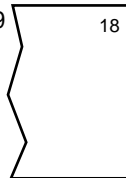

To select three-digit channel:

Press -/-- button repeatedly to display "--".

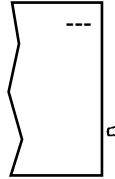

Press 1-2 buttons.

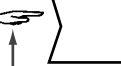

Press 0-9 buttons.

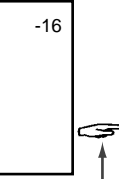

Press 0-9 buttons.



168

! Notes:

The maximum channel number is 254, the set does not act if the channel number you input is out of the range of 0~254.

2 Use CH+ or CH- button

Press **CH+** button, the channel number increases;
Press **CH-** button, the channel number decreases.

3 Use previous channel button

Press this button to switch between the current channel and previous channel.

Adjusting Picture

Contrast/Colour/Brightness/Sharpness/Picture Mode

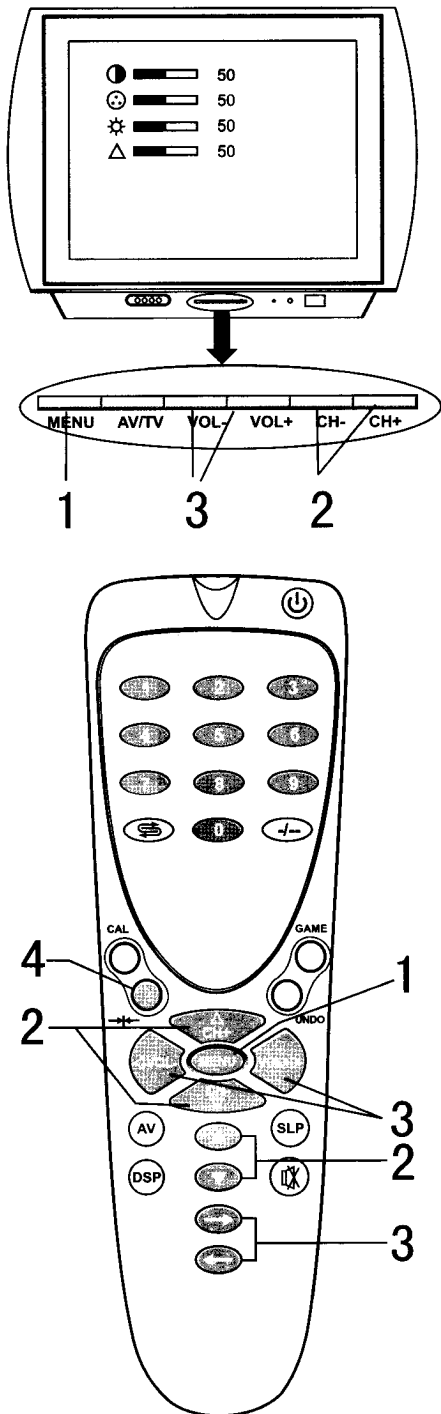

Adjusting Picture

- 1 Press MENU button, the Picture menu page displays.
- 2 Press CH+ or CH- button to select item.
- 3 Press VOL+ or VOL- button to adjust.

Item	VOL-	VOL+
● Contrast	weaker	stronger
☺ Color	paler	deeper
✱ Brightness	darker	lighter
△ Sharpness	softer	sharper
⊙ Tint*	purplish	greenish

* Note: The item **TINT** is for NTSC only.

The adjusted settings are stored in the user-set mode. There are three preset picture modes and one user-set picture mode. Press the →|← button to select a picture mode according to your favourites.

- 4 Press →|← button to select picture mode.

Item	Picture mode		
	☑ Standard	☑✱ Vivid	☑ Soft
● Contrast	80	100	50
☺ Color	50	50	50
✱ Brightness	50	80	30
△ Sharpness	50	50	50
⊙ Tint	50	50	50

Notes:

The above parameters maybe different in different models.

In the user-set picture mode you can adjust picture according to your favourites.

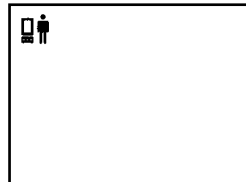

Sound Control

Adjusting Volume/Muting the Sound

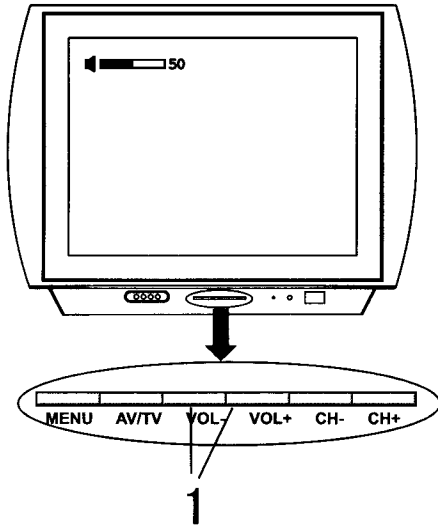

1 Use VOL+ or VOL- button.

Press VOL+ button, the volume increases;
Press VOL- button, the volume decreases.
The minimum volume is 0 and the maximum volume is 100.

2 Use MUTE button.

If you want to mute the sound, press MUTE button on the remote.

To resume the sound, press this button again.

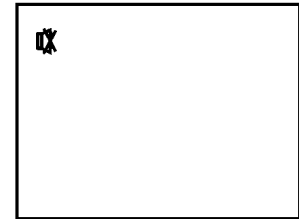

! Notes:

You can also resume the sound by pressing VOL+ or VOL- button.

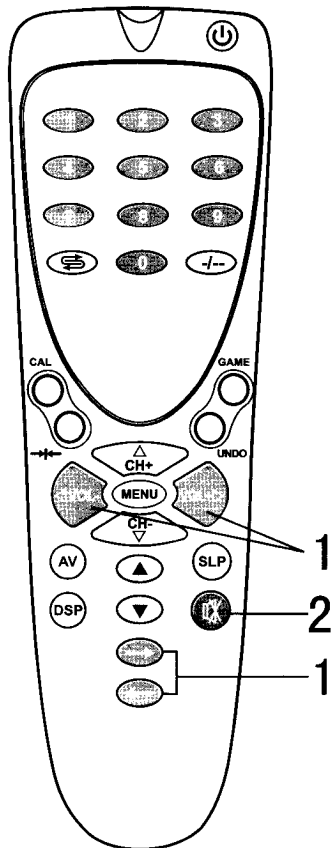

Clock Setting

Sleep Timer/Timer/Time Off

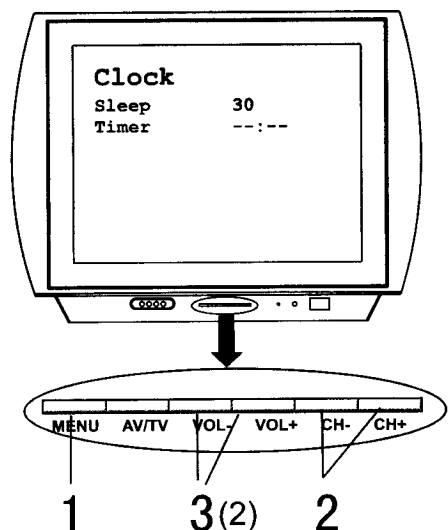

Setting Sleep Time

- 1** Press MENU button repeatedly to enter into Clock menu page.
- 2** Press VOL+ or VOL- button to set sleep time. The sleep time switches among Off, 10, 20, 30, 40, 50 and 60 minutes. When the time is up the set auto goes to STANDBY.

You can also use Sleep button to set the sleep time quickly.

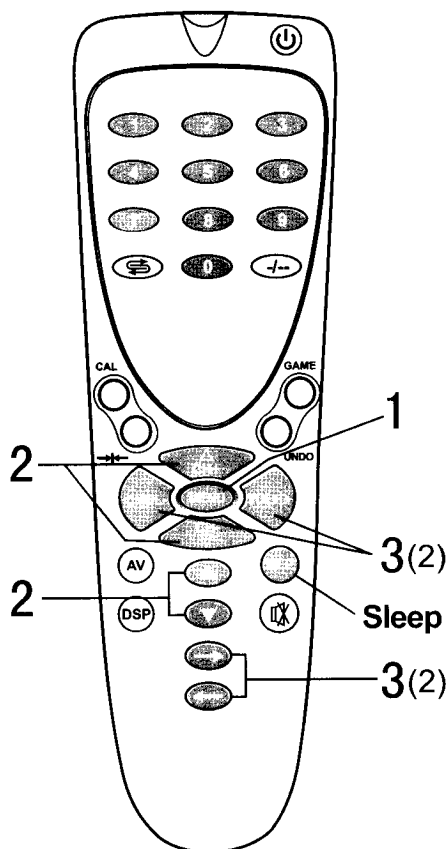
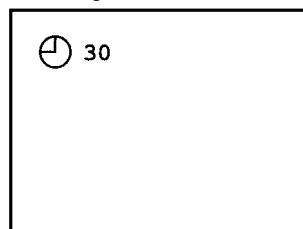

Setting Time

- 1** Press MENU button repeatedly to enter into Clock menu page.
- 2** Press CH- button to select Timer item.
- 3** Press VOL+ or VOL- button to set current time.

Notes:

The Time Off and Time On items are available only after you finish setting the Timer item.

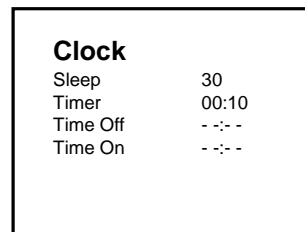

Setting Time off

- 1** Press MENU button repeatedly to enter into Clock menu page.
- 2** Press CH- button twice to select Time Off item.
- 3** Press VOL+ or VOL- button to set a Off time.

The set auto goes to STANDBY when the Off time elapses.

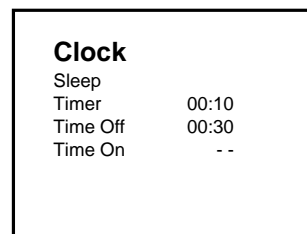

Time On/ Alarm Channel

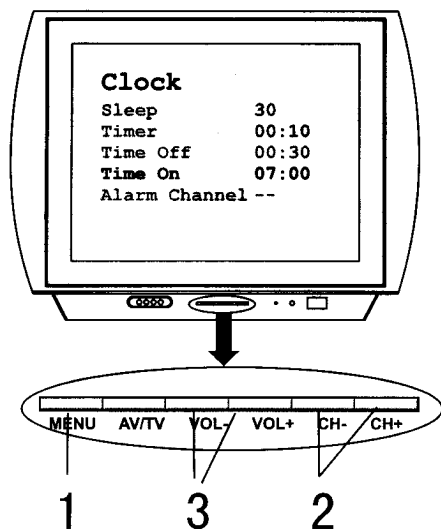

Setting Time On

- 1** Press MENU button repeatedly to enter into Clock menu page.
- 2** Press CH- button repeatedly to select Time On item.
- 3** Press VOL+ or VOL- button to set On time.
After you finish setting Time On item, press the STANDBY  button on the remote control. Then the TV set auto turns on when your preset time elapses.

! Notes:

The Alarm Channel item is available only after you finish setting Time On item.

Setting Alarm Channel

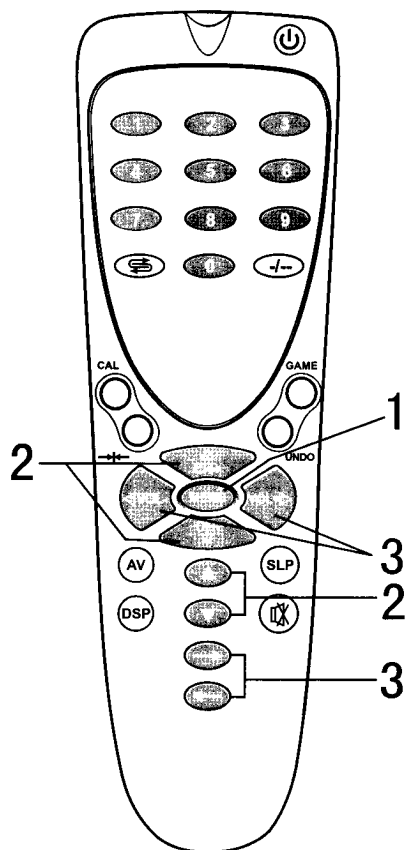

- 1** Press MENU button repeatedly to enter into Clock menu page.
- 2** Press CH- button repeatedly to select Alarm Channel item.
- 3** Press VOL+ or VOL- button to select a channel number.

When the preset On Time elapses, the set auto turns on and goes to the channel set on the Alarm Channel item.

Clock

Sleep	30
Timer	00 : 10
Time Off	00: 30
Time On	07: 00
Alarm Channel	99

! Notes:

1. When you adjust time by VOL+ or VOL- button, the increasing/ decreasing step of time is 1 minute in every press. If you press and hold the button for more than 1 second, the step of time is 1 hour.
2. Once the functions of Time On or Time Off fulfil, you need to set the On Time or Off Time again if you want to use this function next time.
3. After you finish setting Time Off item, if the set auto goes to STANDBY because there is no signal input for a continuous 15 minutes, or if you turn off manually, then the preset Off Time will be cancelled. As the same way, turn on the set in advance will cancel the Time On and Alarm Channel settings.
4. Once you turn off the set by press the Power Switch, all settings in the Clock menu page will be cancelled in next time's turning on.

System Setting

Select OSD Language/Calendar/Hotel mode

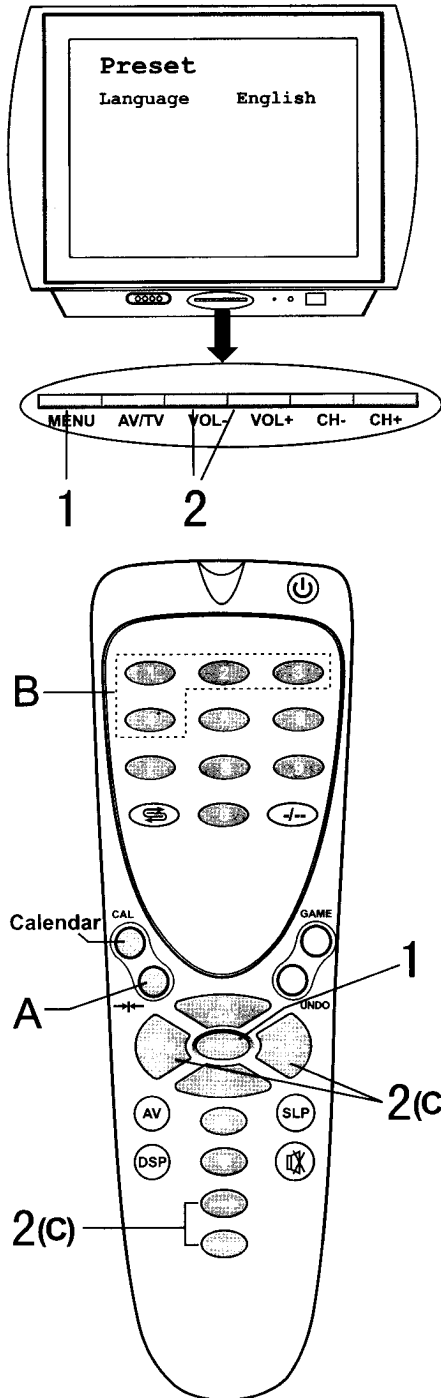

Selecting OSD language

There are multi OSD languages in this TV set provided for you to select:

- 1 Press MENU button twice to enter into Preset menu page.
- 2 Press VOL+ or VOL- button to select OSD language.

Calendar setting

Press CAL (calendar) button on the remote controller to display calendar.

You can adjust month by VOL+/- buttons and year by CH+/- buttons.

JAN 2008						
SU	MO	TU	WE	TH	FR	SA
		01	02	03	04	05
06	07	08	09	10	11	12
13	14	15	16	17	18	19
20	21	22	23	24	25	26
27	28	29	30	31		

Hotel mode

The TV set provides Hotel mode lock or unlock function. When the Hotel is in lock mode, the Program menu page will be shielded and the maximum volume is 60. The limitation of these functions is especially useful in hotel or when you do not let other user change your settings in Program menu.

To enter into Control menu page

- A. Press Picture mode →|← button and picture mode icon displays.
- B. Before the icon disappear, continue to press 4, 3, 2, 1 on the remote control.
- C. Press VOL+ or VOL- button to switch between Off and On.

Control

Hotel Lock	off
Child Lock	off

Child Lock/Game

Child Lock

Firstly, please refer to the Hotel mode on the previous page to enter into the Control menu page. Press CH - button to select Child Lock item and then press VOL+ or VOL- button to switch between On or Off. When the Child Lock is set to On, all programs will be shielded and the screen is black.

Playing Game

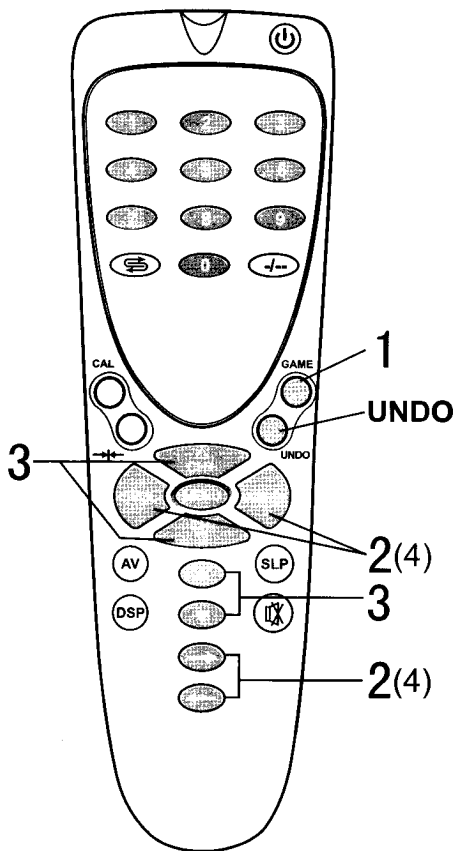

1 Press **GAME** button to enter into Game menu page.

2 Press **VOL+** or **VOL-** button to select a map.

3 Press **CH-** to select Game Start item.

4 Press **VOL+** or **VOL-** button to start game.

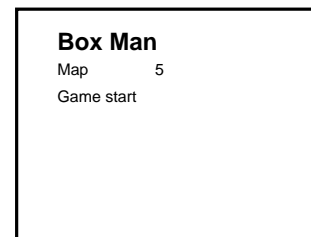

How to play the name?

Description of icons:

- ☺ :the man you control.
- ☒ :the box to push.
- :the destination to push the box to.
- ≡ :the wall.

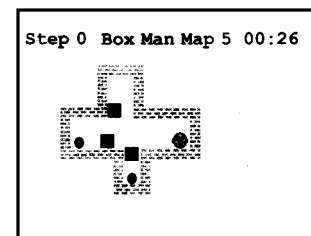

The player should control the man to push the box (just push, not pull) to the destinations within the wall by using CH+ CH-, VOL+ and VOL- buttons. When you push all boxes to the relevant destinations then you win and it goes to next map.

You can press UNDO button to cancel your last action.

Press GAME button to exit game. If you want to play again then press GAME button again.

! Notes:

1. You can not pull the box, but push it.
2. If there is wall in front of the box, you can not push it.
3. If there are two continual boxes, you can not push them.

Troubleshooting Guide

Trouble Shooting

Before calling service personnel, please check the following chart for a possible cause to the trouble you are experiencing.

Symptoms	Check the following items
Power is not turned on	<ul style="list-style-type: none"> □ Be sure the power cord is plugged in.
Poor colour, poor tint	<ul style="list-style-type: none"> □ Contrast, colour, tint are not correctly adjusted
Spots appear on the screen	<ul style="list-style-type: none"> □ Possible interferences of automobiles, motorcycle, trolley bus, neon lamps, etc.
Stripes appear on the screen	<ul style="list-style-type: none"> □ Possible interference of electronic interference from another TV set, a computer, an electronics game machine, a broadcast station, etc.
Double images or "ghosts"	<ul style="list-style-type: none"> □ This may be caused by reflections from nearby mountains or buildings. □ Check the antenna direction.
Snowy picture	<ul style="list-style-type: none"> □ It is possible that the aerial "lead-in" is damaged or comes off. □ Check the antenna direction.
No Program menu page and the maximum volume is only 60.	<ul style="list-style-type: none"> □ Check whether the HOTEL mode is in LOCK status.
TV cabinet creaks	<ul style="list-style-type: none"> □ Even if the picture or the sound is normal, changes in room temperature sometimes makes the TV cabinet expand or contract, making a noise. This does not indicate a malfunction.
Remote controller does not work	<ul style="list-style-type: none"> □ The batteries may be worn out. □ The batteries may be installed with their polarity reversed.
Unevenness in colour in some parts of the screen	<ul style="list-style-type: none"> □ When the set is switched on, do not shift or move the set around. Sometimes it may develop an unevenness in colour in some parts of the screen. This can be eliminated by switching off the set with the POWER switch and wait for 10 minutes before switching on again.
The screen is black	<ul style="list-style-type: none"> □ Check whether the Child Lock is set to On.

Specifications

Specifications

Power Supply: AC 240V, 50Hz
Power Consumption: 70W
Dimensions (mm): 590 (W) x 448 (H) x 483 (D)
Weight (kg): 23
CRT: 51cm

TV system & channel range

System	VHF	UHF	CATV
PAL-B/G	2-12	21-69	X~Z+2, S1~S41

Colour System: PAL-B/G NTSC playback
Sound output: 1.5W x 2
Accessories: Remote controller X 1

ⓘ Design and specifications are subject to change without notice.

PALSONIC CORPORATION PTY LTD
1 JOYNTON AVENUE
WATERLOO NSW 2017 AUSTRALIA
TEL:(02)9313 7111
FAX:(02)9313 7555
www.palsonic.com.au

**PALSONIC CUSTOMER SERVICE
TELEPHONE
AUSTRALIA: 1300 657 888**

604-J21193-03

Free Manuals Download Website

<http://myh66.com>

<http://usermanuals.us>

<http://www.somanuals.com>

<http://www.4manuals.cc>

<http://www.manual-lib.com>

<http://www.404manual.com>

<http://www.luxmanual.com>

<http://aubethermostatmanual.com>

Golf course search by state

<http://golfingnear.com>

Email search by domain

<http://emailbydomain.com>

Auto manuals search

<http://auto.somanuals.com>

TV manuals search

<http://tv.somanuals.com>