

OWNER'S MANUAL

Palsonic

51CM CORDLESS REMOTE COLOUR TELEVISION
MODEL: 5169P



Type Tested
Electrical
Safety

AS/NZS 3250 Lic 4164
Standards Australia
APP No: N15959

PALSONIC CORPORATION PTY LTD
1 JOYNTON AVENUE
WATERLOO NSW 2017 AUSTRALIA
TEL:(02)9313 7111
FAX:(02)9313 7555
www.palsonic.com.au

**PALSONIC CUSTOMER SERVICE
TELEPHONE
AUSTRALIA:1300 657 888**

Congratulations on your purchase of this Palsonic colour television receiver.

We recommend that you thoroughly read this manual before use to fully enjoy the many functions and excellent effects of this receiver

Retain this manual in an easily accessible location for future reference.

* Screen displays and illustrations in this manual may differ from the actual ones for better visibility.

Contents

INTRODUCTION —————	OPERATION —————
Features1	Turning the Power On/Off6
NOTES FOR OPERATION —————	Tuning in7
Cautions for safety2	To preset channels (Auto search).....7
INSTALLATION —————	To preset channels (Manual search).....8
Antenna connection3	To skip unnecessary position numbers..9
Battery installation3	MFT (Manual Fine Tuning).....9
APPEARANCE —————	The setting of colour system &
Front view4	Channel selection10
Back view4	Convenient Picture Controls11
Remote controller5	Convenient Sound Controls12
	Other functions13
	Sleep timer and to select the
	language for OSD.....13
	CONNECTING OTHER EQUIPMENT —
	External Equipment Connections14
	To connect AV input terminals.....14
	To connect TV output terminals.....15
	OTHERS —————
	Troubleshooting16
	Specifications16

INTRODUCTION

Features

- **Hyperband**
- **English/Chinese on-screen menu display**
- **100 preset channels**
- **Auto-search, manual search**
- **Intellectualized I²C-bus control**
- **Sleep timer, Auto Power-Off & blue background display**
- **Four picture modes' setting**
- **AUDIO/VIDEO input & output terminals**
- **S-VHS Terminal**
- **Advanced digital picture improvement circuit**
 1. **Built-in digital comb filter (NTSC system)**
To attain the complete separation of brightness and colour signals, to reduce colour interface, blurry and dotted interruptions, to make the picture clearer.
 2. **Black level stretching circuit**
To extend the dynamic scope of the picture, to make the picture's level clearer

NOTES FOR OPERATION

- * Do not let the TV set be in stand-by condition for a long period of time. When it is not in use, please turn off the power supply and remove the power plug. When it is to be left unattended for a prolonged period of time, it is recommended to disconnect the connection to the outdoor aerial, to avoid thunder strike.
- * Please follow cautions for safety in the TV set instructions, and all warnings and descriptions denoted on the TV set.

Cautions for safety

Note: This TV set can be operated on an AC power of 240V, 50Hz. You should not use power supply of the other type.

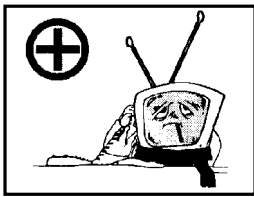

When an unusual situation occurs, turn off the power switch at once and remove the plug from the wall outlet. Contact a qualified service department in your local area.

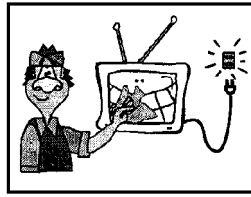

In order to wipe dust off the picture tube or off the cabinet, you should remove the power plug from the wall outlet first. You can wipe lightly with a piece of dry, clean, soft cloth.



Do not expose the TV set to rain or excessive moisture, to prevent tire disaster or electric shock. Avoid using the set in very warm or damp places. Never use it in a bathroom.

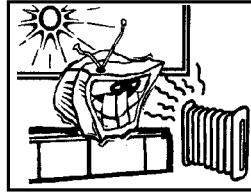

The TV set should be placed on an adequate place without exposing it to direct sunlight and other sources of heat to prevent the deformation of the cabinet or damage to components.

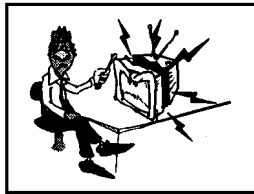

There exists High Voltage in this TV set. Do not remove the cover to avoid danger.

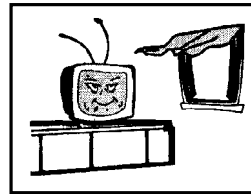

Do not cover the Ventilating holes in the cabinet. Keep a space of more than 5cm from the walls to the TV set, to guarantee the good ventilation.

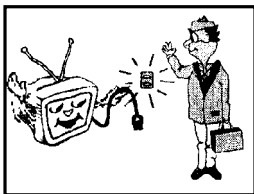

When the TV set is to be left unattended, please turn off the power switch and remove the plug from the wall outlet.

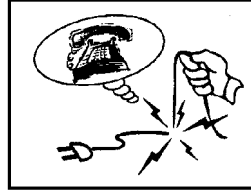

When the power cord or the plug is damaged, please contact a qualified service department to get service.

Installation

Antenna Connection

To ensure a bright-coloured and clear picture, you should use an outdoor aerial or CATV cable. If the signals are strong enough, you may use an indoor aerial.

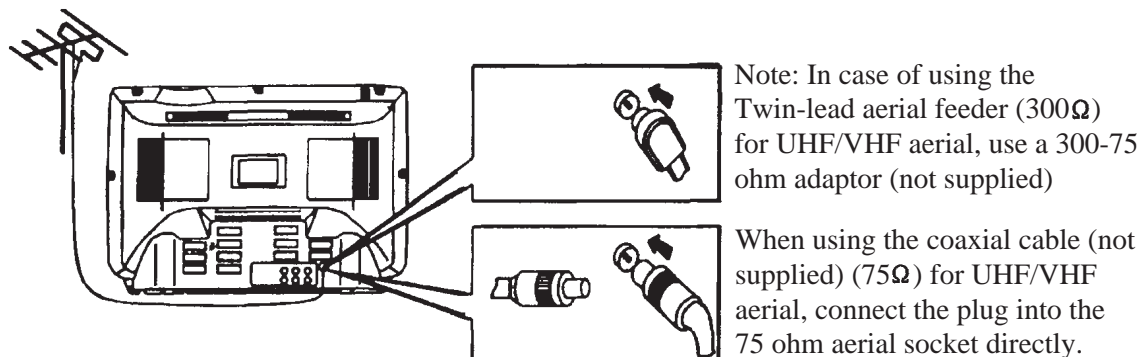

Note:

When you connect the outdoor aerial cable to the aerial terminal on the TV set, please turn off the power switch on the TV while connecting the antenna lead.

In thunder and lightning weather, please disconnect the outdoor aerial to avoid thunder/lightning strike.

Battery installation

(1) Remove the back battery cover.

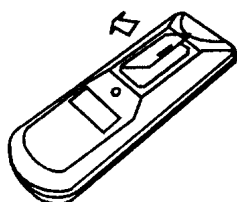

(2) Insert two size AAA batteries according to the polarity indication inside the remote controller.

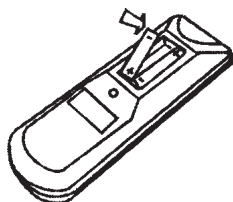

Effective range of the remote control operation

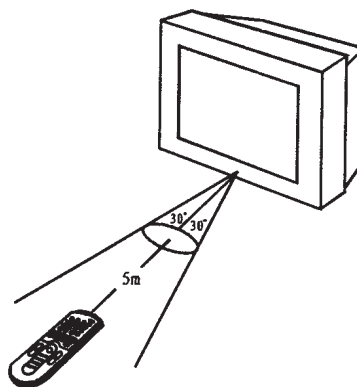

Notes:

1. When the remote controller is not used for an extended period of time or the batteries are worn out, please remove the batteries in time to avoid battery leakage.
2. Avoid moisture and mechanical shock to the remote controller.
3. Do not drop, dampen or disassemble the remote controller.

Appearance

Front view

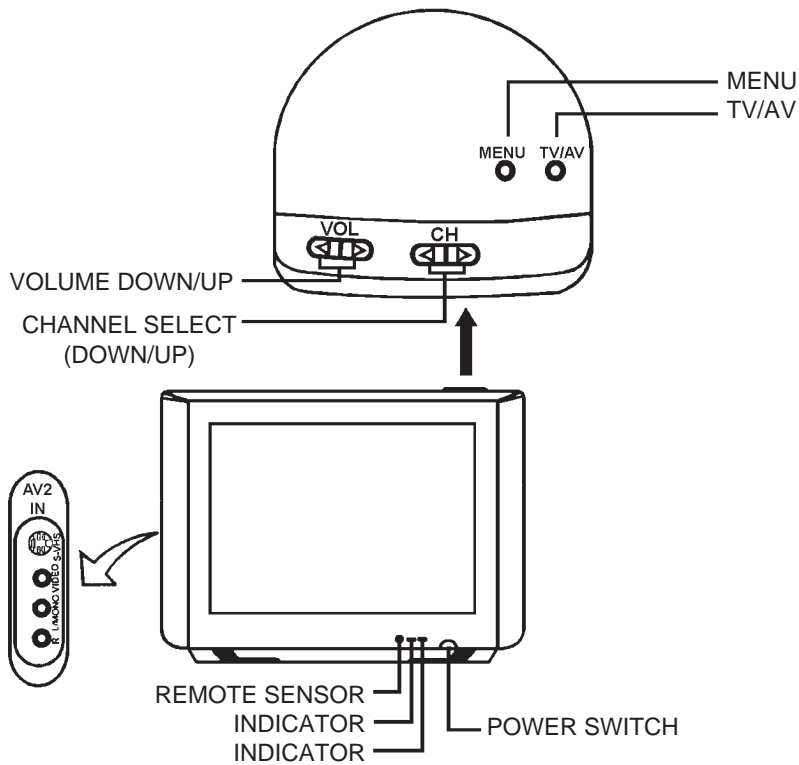

Note:* Functions of MENU, TV/AV, VOL \leftarrow/\rightarrow , CH \leftarrow/\rightarrow , are also provided to the remote controller.

* S-VHS is S-VIDEO.

Back View

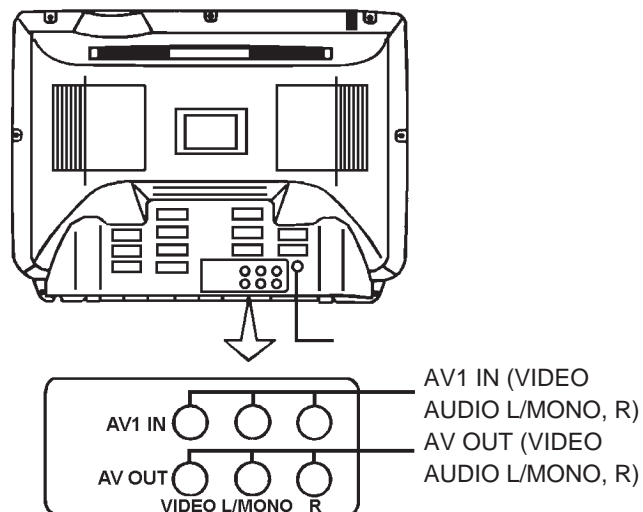

Remote Controller

The Remote Controller

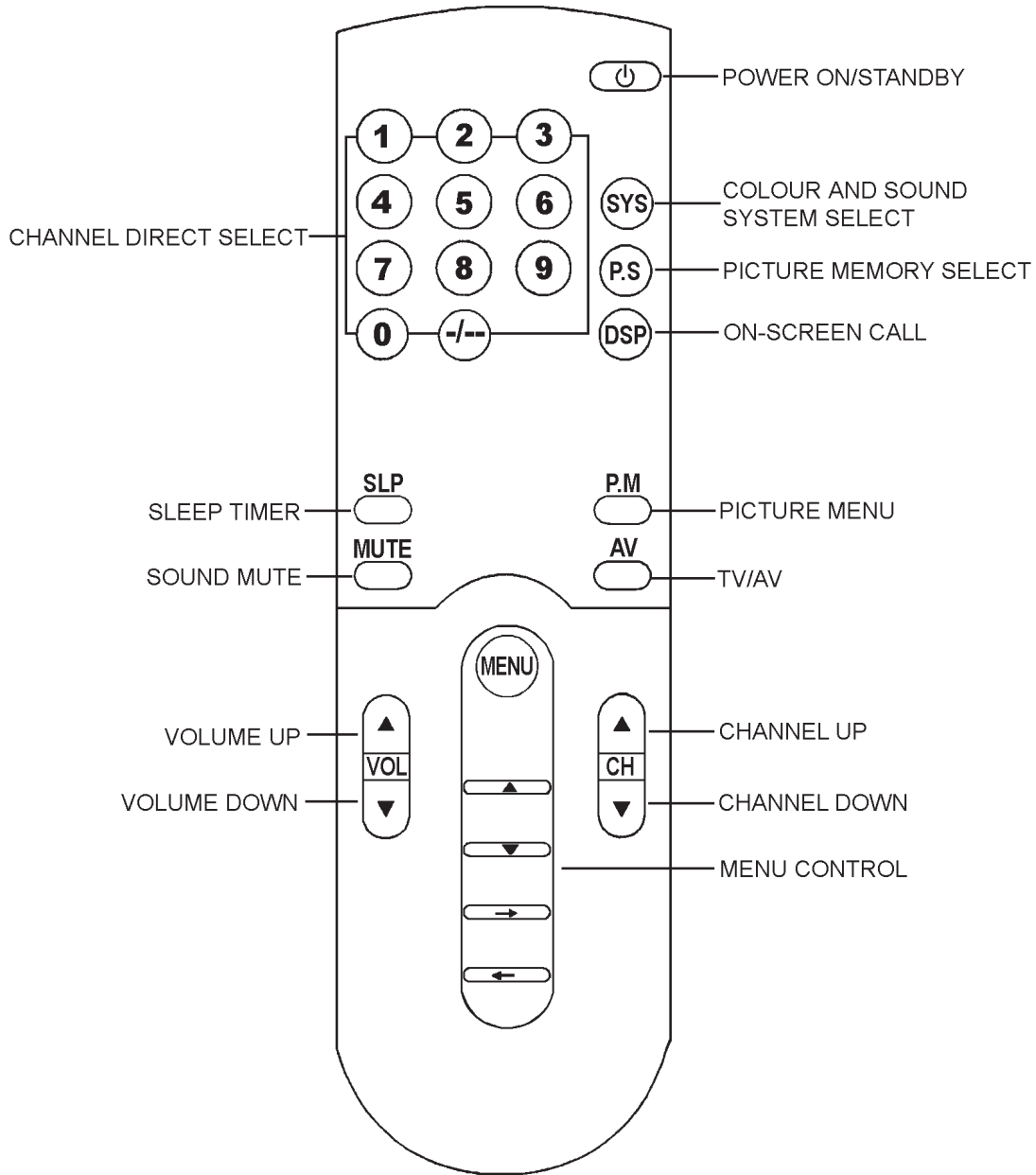

OPERATION





Turning the Power On/Off

- The following describes how to turn the TV on/off using the TV's main switch and the remote controller.

To turn the power on/off

1. Press the **POWER** switch, the red power indicator lights up.

2. If no picture appears on the screen, press the  button or any one of 0~9 number buttons on the remote controller to turn the set on.

Without using the remote controller, you can directly press **VOL**   or **CH**   or TV/AV button on the set to turn on the TV.

*Note: If there are no input signals to the TV when the TV set is on, a blue background will appear on the screen (when B.B (blue back) is set ON.)

After 15 minutes if there are still no signals to the TV, it will enter into standby mode automatically

3. Press the **POWER** switch to turn off the set completely.

4. If you want to turn off the TV temporarily, press the  button on the remote controller to switch the set to standby mode.

Special indication:

Last-Mode-Memory: after turning off the power, the last TV mode, picture and sound setting mode and preset channels all are memorised. Therefore, next time you turn on the TV, the TV will work in the previous setting mode.

- If you directly pressed the main power switch on the TV to turn it off, you must press the main power switch to turn on the TV.
- If you pressed the main power switch to turn off the TV when in standby mode, press the main power switch and then operate from the remote controller to turn the TV on.

Auto-Power-Off function: there are two kinds of Auto-Power-Off function:

1. If a vacant channel is tuned or TV broadcast for a day is finished, the TV will automatically turn off after about 15 minutes.
2. Sleep-timer function. However, if the Sleep-timer is operating, it takes precedence, that is, the function of Auto-Power-Off, if no signals received will be ineffective.

OPERATION

Tuning in

- First, use the AUTO SEARCH function to preset all the active channels in your local area automatically.
Then, arrange the preset channels with the MANUAL SEARCH, MFT (Manual Fine Tuning) and SKIP functions so that you can tune into only desired channels.

To preset channels (Auto search)

There are two ways to preset channels: to preset channels automatically and to preset channels manually. Below we will describe how to preset the channels by making use of the menu.

To enter into menu

Press the **MENU** button repeatedly to call up the **POS. MEMORY** menu on the screen

Note: The **MENU** button refers to the **MENU** button on the remote controller or on the TV set, the **▼** or **▲** button refers to the **▼** or **▲** button on the remote controller or **CH ◀/▶** button on the TV set, the **→** or **←** button refers to the **→** or **←** button on the remote controller or the **VOL ◀/▶** button on the TV set.

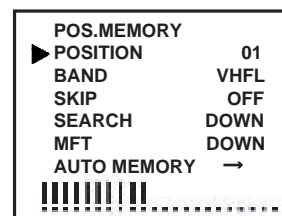

AUTO SEARCH

1. Press the **▼** or **▲** button to select and highlight **AUTO MEMORY**.

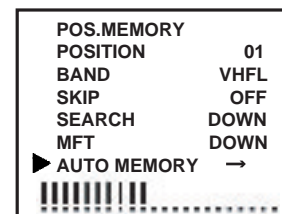

2. Press the **→** button to start the AUTO SEARCH. All active channels will be preset and stored into the memory automatically. After presetting, the TV will return to the first channel program.

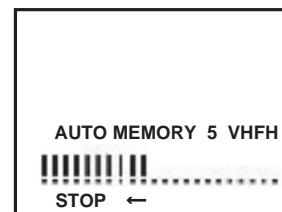

3. During the process of AUTO SEARCH, pressing the **←** button on the remote controller will stop the process and the TV will return to the first channel program.

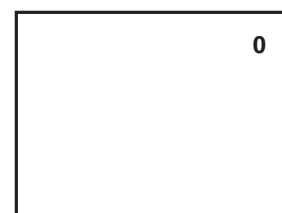

OPERATION

Tuning in (continued)

- Use the MANUAL SEARCH function if desired channels can not be preset with the AUTO-SEARCH or if you would like to preset channels to specific position numbers one by one.
- It is convenient to set the channel numbers to the same position numbers using MANUAL SEARCH and SKIP functions.

To preset channels (Manual search)

Manual search

If AUTO SEARCH can not preset the desired channels, or you want to preset the desired channels one by one with the preferred channel numbers, please make use of Manual search.

1. Enter into **POS.MEMORY** menu, press the or button to select and highlight **POSITION**. Press the or button to select a desired position number (from 00~99).

Note: press the or button to select a channel number within 0.7 second. Press and hold the or button for over 0.7 second to select a decimal number.

```
POS.MEMORY
▶ POSITION      01
BAND          VHFL
SKIP          OFF
SEARCH        DOWN
MFT           DOWN
AUTO MEMORY   →
!!!!!!!!.....
```

2. Press the or button to select and highlight SEARCH. Press the button to search channels from current channel to higher channel. Press the button to search channels from current channel to lower channel. When a channel is located, the searching stops, this channel is then memorised with the preset channel number.

```
POS.MEMORY
POSITION      01
BAND          VHFL
SKIP          OFF
▶ SEARCH      DOWN
MFT           DOWN
AUTO MEMORY   →
!!!!!!!!.....
```

Note: you can also make use of **BAND** selection to quicken the searching process in your desired band. Pressing the or button moves the band to the next step in the sequence below.



```
POS.MEMORY
POSITION      01
▶ BAND        VHFL
SKIP          OFF
SEARCH        DOWN
MFT           DOWN
AUTO MEMORY   →
!!!!!!!!.....
```

3. When you want to store another channel with another position, repeat steps 1 & 2 above.

OPERATION

Tuning in (continued)

To skip unnecessary position numbers and MFT (Manual Fine Tuning)

To skip a position number

After presetting the channels, you can skip unnecessary position numbers so that only the channels you want to watch are selected.

1. Enter into the *POS. MEMORY* menu, select and highlight *POSITION*, then select the unwanted program number with the → or ← button.

```
POS.MEMORY
▶ POSITION      01
BAND          VHFL
SKIP          OFF
SEARCH        DOWN
MFT           DOWN
AUTO MEMORY   →
!!!!!!!!!!!!
```

2. Press the ▲ or ▼ button to move the cursor to "*SKIP*". Press the → or ← button to select "*SKIP ON*".

After completion of channel preset, the position number will then be skipped when you select channels with the CH▲/▼ button.

If you want to skip other unwanted channels, repeat step 1 above to change the channel number.

```
POS.MEMORY
POSITION      01
BAND          VHFL
▶ SKIP        OFF
SEARCH        DOWN
MFT           DOWN
AUTO MEMORY   →
!!!!!!!!!!!!
```

To restore a skipped position number

Select the position number you want to restore. Press the ▲ or ▼ button to move the cursor to "*SKIP*". Press the → or ← button to select "*SKIP OFF*".

MFT (Manual Fine Tuning)

When sound and picture's effect of a channel is poor (for example: one or two CATV channel's sound and picture are not standard), you can correct them by making use of Manual Fine Tuning).

1. Enter into *POS.MEMORY* menu, select the channel you want to manually fine tune.

```
POS.MEMORY
▶ POSITION      01
BAND          VHFL
SKIP          OFF
SEARCH        DOWN
MFT           DOWN
AUTO MEMORY   →
!!!!!!!!!!!!
```

2. Press the ▲ or ▼ button to select and highlight MFT, then press the → or ← button, the channel begins fine tuning until the optimum picture and sound is achieved.

```
POS.MEMORY
POSITION      01
BAND          VHFL
SKIP          OFF
SEARCH        DOWN
▶ MFT         DOWN
AUTO MEMORY   →
!!!!!!!!!!!!
```

Note: if some channel's colour is abnormal, it may be that the setting of the colour system is wrong, please do adjustment according to *The setting of colour* (on page 10) to set the colour system.

3. To exit the menu, press the **MENU** button repeatedly.

OPERATION

The setting of colour system & channel selection

The setting of colour system

1. Press the SYS button, the colour system will be displayed on the screen.



2. If the colour is abnormal, press the → or ← button to select the proper colour system. Every time you press the → or ← button, the colour system will change in the sequence below.

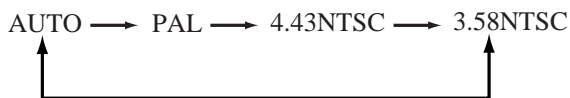

Now you can watch the broadcasting TV program at the preset channel.

Channel Selection

You can select your desired TV program by one of the following methods.

Using the direct select buttons

- To select a one-digit position number, press the -/- - button to display "-" and 0~9 to select a number. (0~9)



- To select a two-digit position number, press -/- - to display "-" and press 0~9 to select number (10~99)



Using the CH▲/▼ buttons

Press CH▼ to select lower position numbers; CH▲ to select higher ones.

OPERATION

Convenient Picture Controls

Selectable picture

To select the picture mode

You can select the picture quality instantly among three preset modes and one user-set mode.
Press the **P.S** button to select the desired picture quality.

MEMORY1, **MEMORY2**, **MEMORY3** and **MEMORY 4**(user-set) can be selected cyclically.

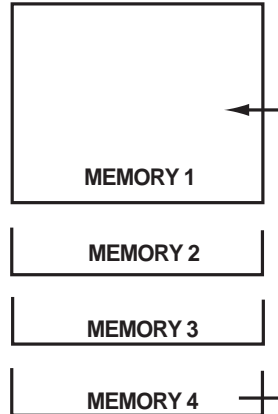

To set the desired picture quality to the MEMORY position

1. Press the **MENU** button to enter into the **PICTURE** menu. Or press the **P.M** button, the picture control menu appears.

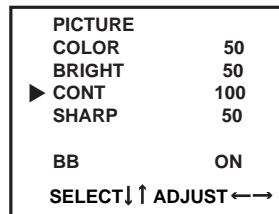

2. Press the **▲** or **▼** button to select the desired adjusting item, and press the **→** or **←** button to adjust the level.

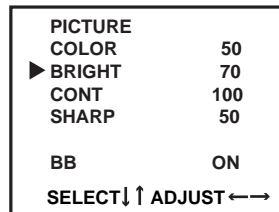

Item	Pressing (MEMORY 4)		MEMORY1	MEMORY2	MEMORY3
	←	→			
COLOR	paler	deeper	50	50	50
BRIGHTNESS	darker	lighter	50	50	50
CONTRAST	weaker	stronger	100	50	30
SHARPNESS	softer	sharper	50	50	50
*TINT	purplish	greenish	50	50	50
B.B (blue back)	ON or OFF				

* TINT is for NTSC system only.
The adjusted level is stored in the MEMORY position.

OPERATION

Convenient Sound Controls

Adjusting the volume and muting the sound

To adjust the sound volume

Adjust the sound volume with the **VOL ▲/▼** buttons.
Press the **VOL ▼** button to decrease the sound.
Press the **VOL ▲** button to increase the sound.



To mute the sound

The muting function is convenient when you need to pay attention to surrounding sounds, answer a phone call, receive a visitor, etc.

1. Press the **MUTE** button to mute the sound.

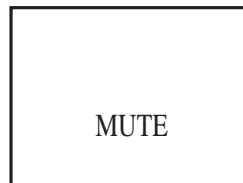

2. To restore the sound, press the **MUTE** button again or **VOL ▲/▼** buttons.

OPERATION

Other functions

Sleep timer and to select the language for the OSD

SLEEP timer

Making use of the Sleep timer function allows you to have the set automatically turned off after a preset time.
Press the SLP button every time, the time displaying on the screen will change in the sequence below:

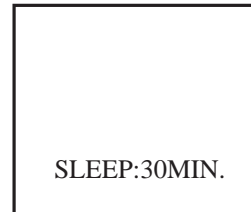
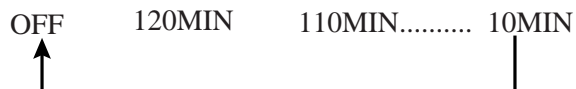

To select the language for the OSD

Making use of this function can switch the language for the OSD to either English or Chinese.

1. Press the MENU button repeatedly until the **OTHER** menu appears on the screen.

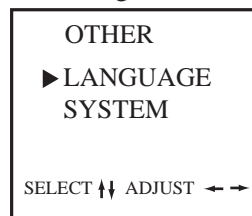

2. Press the ▲ or ▼ button to move the cursor to **LANGUAGE**. Press the → or ← button to enter into the menu of **LANGUAGE**.



3. Press the ▲ or ▼ button to select the desired language. The selected language is displayed in red and the screen menu is automatically displayed in that language.

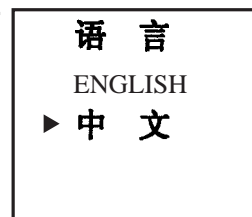

3. Press the MENU button repeatedly to exit the menu.

CONNECTING OTHER EQUIPMENT

External Equipment Connections (continued)

- The following describes how to use and connect the TV with other AV equipment. Refer to the owner's manual of the equipment to be connected as well.

To connect AV input terminal

You can connect video equipments such as a VTR and video camera to this TV and enjoy the high quality picture and sound.

If your video equipment has a S-VIDEO output terminal, connect it to the S-VIDEO input terminal (special S-VIDEO type) of the unit. If not, connect it to the VIDEO terminal (photo type)

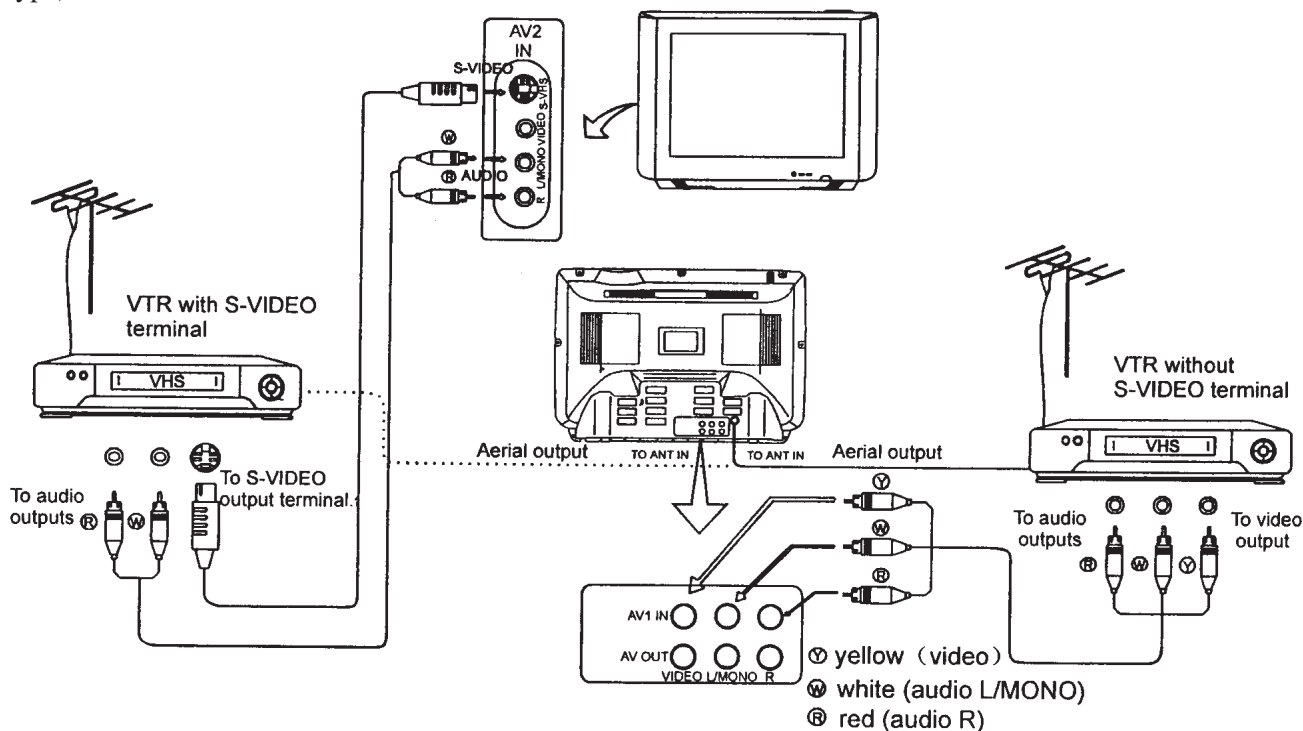

To select the input, press the TV/AV button on the TV set or AV button on the remote controller repeatedly until you see the corresponding input indication on the screen. To return to aerial input, press the AV button until it displays program number, or press channel select button or the CH ▲/▼ button.



If the colour of video input is abnormal, the colour system setting may be incorrect. Press the SYS button until the **COLOUR AUTO** is displayed on the screen. If the picture is still abnormal, press the → or ← button until normal colour appears.

NOTE on the S-VIDEO terminal

S-VIDEO input terminal and the VIDEO terminal can not be used at the same time. To use equipment connected to the VIDEO terminal, disconnect plug from the S-VIDEO terminal.

CONNECTING OTHER EQUIPMENT

External Equipment Connections (continued)

- The following describes how to use and connect the TV with other AV equipment. Refer to the owner's manual of the equipment to be connected as well.

To connect TV output terminal

You can connect an audio system to the TV output terminals on the set to enjoy a high-quality TV sound. The TV output terminals only output TV programme signals.

Note: the set is incorporated with L/MONO and R AUDIO terminals which is convenient for you to connect external audio equipment.

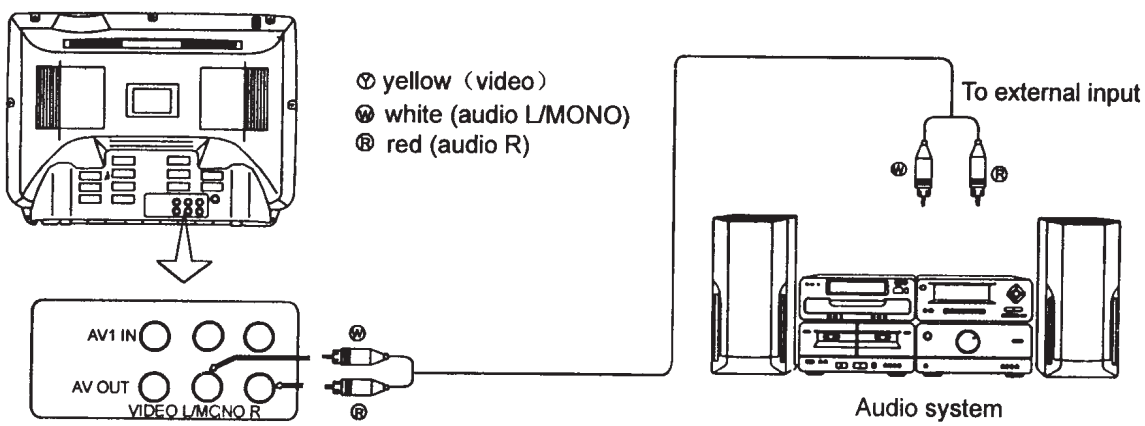

OTHERS

Troubleshooting Guide

- Before calling service personnel, please check the following chart for a possible cause to the trouble you are experiencing.

Symptoms	Check the following items
No power, red indicator is not lit up	<ul style="list-style-type: none"> • Be sure the power cord is plugged in.
Poor colour, poor tint	<ul style="list-style-type: none"> • Contrast, colour, tint are not correctly adjusted
Spots appear on the screen	<ul style="list-style-type: none"> • Possible interferences of automobiles, motorcycle, trolley bus, neon lamps, etc.
Stripes appear on the screen	<ul style="list-style-type: none"> • Possible interference of electronic interference from another TV set, a computer, an electronics game machine, a broadcast station, etc.
Double images or "ghosts"	<ul style="list-style-type: none"> • This may be caused by reflections from nearby mountains or buildings. • Check the antenna direction.
Snowy picture	<ul style="list-style-type: none"> • It is possible that the aerial "lead-in" is damaged or comes off. • Check the antenna direction
The remote controller does not work	<ul style="list-style-type: none"> • The batteries may be worn out. • The batteries may be installed with their polarity reversed.
TV cabinet creaks	<ul style="list-style-type: none"> • Even if the picture or the sound is normal, changes in the room temperature sometimes make the TV cabinet expand or contract, making a noise. This does not indicate a malfunction.

Specifications

Power supply:	AC 240V, 50Hz		
Power consumption:	80W		
Dimensions (mm):	590 (W) x 448 (H) x 468 (D)		
Weight (kg):	23		
CRT	51cm		
TV system & channel range			
System	VHF	UHF	CATV
PAL-B/G	2-12	21-69	X~Z+2, S1~S41
Colour system:	PAL-BG, NTSC 3.58/4.43 (AV)		
Sound output:	2.5W		
Accessory:	one remote controller		

* Note: Design and specifications are subject to change without notice.

PALSONIC CORPORATION PTY LTD
1 JOYNTON AVENUE
WATERLOO NSW 2017 AUSTRALIA
TEL:(02)9313 7111
FAX:(02)9313 7555
www.palsonic.com.au

**PALSONIC CUSTOMER SERVICE
TELEPHONE
AUSTRALIA: 1300 657 888**

604-21653-01

Free Manuals Download Website

<http://myh66.com>

<http://usermanuals.us>

<http://www.somanuals.com>

<http://www.4manuals.cc>

<http://www.manual-lib.com>

<http://www.404manual.com>

<http://www.luxmanual.com>

<http://aubethermostatmanual.com>

Golf course search by state

<http://golfingnear.com>

Email search by domain

<http://emailbydomain.com>

Auto manuals search

<http://auto.somanuals.com>

TV manuals search

<http://tv.somanuals.com>