

OWNER'S MANUAL

Palsonic

61CM CORDLESS REMOTE COLOUR TELEVISION
MODEL: 6159G



Type Tested
Electrical
Safety

AS/NZS 3250 Lic 4165
Standards Australia
APP No: N16712

PALSONIC CORPORATION PTY LTD
1 JOYNTON AVENUE
WATERLOO NSW 2017 AUSTRALIA
TEL:(02)9313 7111
FAX:(02)9313 7555
www.palsonic.com.au

**PALSONIC CUSTOMER SERVICE
TELEPHONE
AUSTRALIA:1300 657 888**

Congratulations on your purchase of this Palsonic colour television receiver.

We recommend that you thoroughly read this manual before use to fully enjoy the many functions and excellent effects of this receiver.

Retain this manual in an easily accessible location for future reference.

* Screen displays and illustrations in this manual may differ from the actual ones for better visibility.

Contents

INTRODUCTION —————		
Features	1	
NOTES FOR OPERATION —————		
Cautions for safety	2	
INSTALLATION —————		
Antenna connection	3	
Battery installation	3	
APPEARANCE —————		
Front view	4	
Back view	4	
Remote controller	5	
MENU INSTRUCTION —————		
Introducing the menu	6	
	OPERATION —————	
	Turning the Power On/Off	7
	Tuning in	8
	To preset channels (Auto Search).....	8
	To preset channels (Manual Search).....	8
	To skip unnecessary position numbers.....	10
	MFT (Manual Fine Tuning).....	10
	The setting of colour and sound system.....	11
	Channel selection	12
	Convenient Picture Controls	13
	Convenient Sound Control and Sleep Time ..	14
	SYSTEM setting	15
	Special functions	16-17
	CLOCK setting	18
	Channel reservation	19
	CONNECTING OTHER EQUIPMENT —————	
	External Equipment Connections	20
	To connect AV input terminals.....	20
	To connect MONITOR	
	output terminal.....	21
	OTHERS —————	
	Troubleshooting	22
	Specifications	22

INTRODUCTION

Features

- **Hyperband**
- **English/Chinese on-screen menu display**
- **256 preset channels**
- **Intellectualized I²C-bus control**
- **Full function remote control**
- **ON Timer, OFF Timer**
- **Four picture modes' setting**
- **AUDIO/VIDEO input & output terminals**
- **S-VIDEO Terminal**
- **Program scan function**
- **Games calendar function**
- **Advanced digital picture improvement circuit**
- **Digital AFT technology**
- **Channel reservation**

NOTES FOR OPERATION

- * Do not let the TV set be in stand-by condition for a long period of time. When it is not in use, please turn off the power supply and remove the power plug. When it is to be left unattended for a prolonged period of time, it is recommended to disconnect the connection to the outdoor aerial, to avoid thunder strike.
- * Please follow cautions for safety in the TV set instructions, and all warnings and descriptions denoted on the TV set.

Cautions for safety

Note: This TV set can be operated on an AC power of 240V, 50Hz. You should not use power supply of the other type.

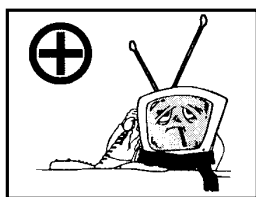

When an unusual situation occurs, turn off the power switch at once and remove the plug from the wall outlet. Contact a qualified service department in your local area.

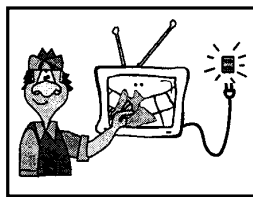

In order to wipe dust off the picture tube or off the cabinet, you should remove the power plug from the wall outlet first. You can wipe lightly with a piece of dry, clean, soft cloth.

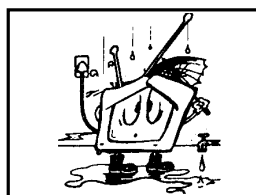

Do not expose the TV set to rain or excessive moisture, to prevent fire disaster or electric shock. Avoid using the set in very warm or damp places. Never use it in a bathroom.

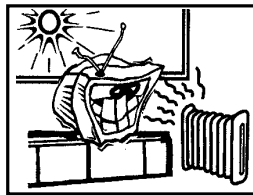

The TV set should be placed on an adequate place without exposing it to direct sunlight and other sources of heat to prevent the deformation of the cabinet or damage to components.

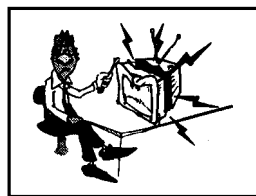

There exists High Voltage in this TV set. Do not remove the cover to avoid danger.

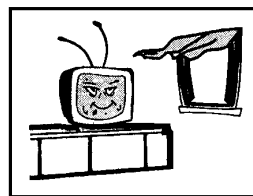

Do not cover the Ventilating holes in the cabinet. Keep a space of more than 5cm from the walls to the TV set, to guarantee the good ventilation.

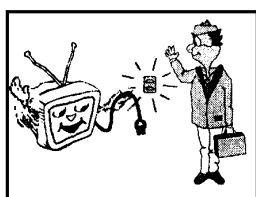

When the TV set is to be left unattended, please turn off the power switch and remove the plug from the wall outlet.

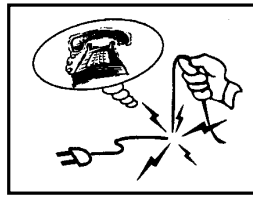

When the power cord or the plug is damaged, please contact a qualified service department to get service.

Antenna Connection

To ensure a bright-coloured and clear picture, you should use an outdoor aerial or CATV cable. If the signals are strong enough, you may use an indoor aerial.

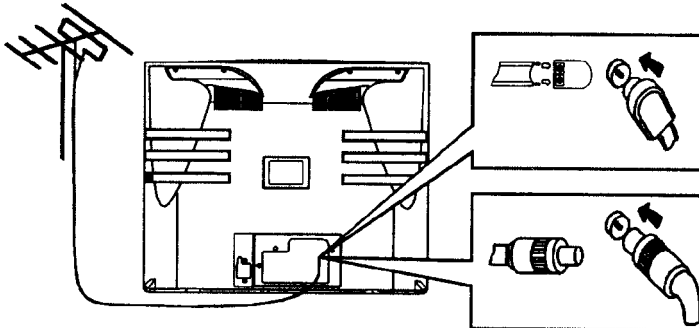

Note: In case of using the Twin-lead aerial feeder (300Ω) for UHF/VHF aerial, use a 300-75 ohm adaptor (not supplied)

When using the coaxial cable (not supplied) (75Ω) for UHF/VHF aerial, connect the plug into the 75 ohm aerial socket directly.

Note:

When you connect the outdoor aerial cable to the aerial terminal on the TV set, please turn off the power switch on the TV while connecting the antenna lead.

In thunder and lightning weather, please disconnect the outdoor aerial to avoid thunder/lightning strike.

Battery installation

(1) Remove the back battery cover.

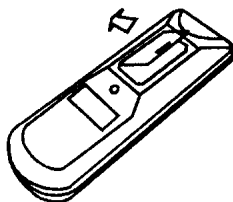

(2) Insert two size AAA batteries according to the polarity indication inside the remote controller.

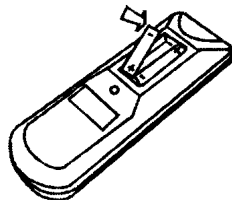

Effective range of the remote control operation

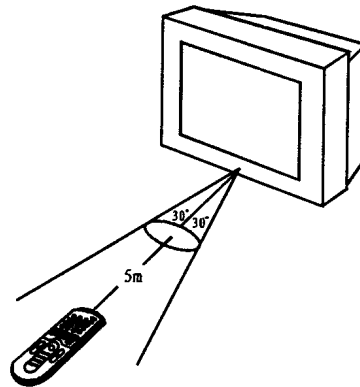

Notes:

1. When the remote controller is not used for an extended period of time or the batteries are worn out, please remove the batteries in time to avoid battery leakage.
2. Avoid moisture and mechanical shock to the remote controller.
3. Do not drop, dampen or disassemble the remote controller.

Front view

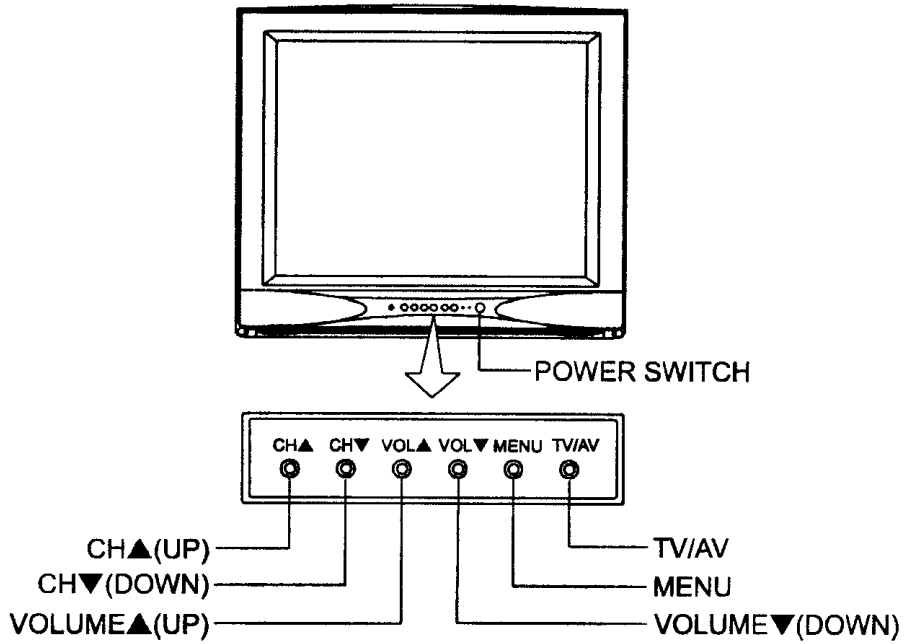

Note: Functions of MENU, TV/AV, VOLUME ▲/▼, CH▲/▼ are also provided to the remote controller.

Back View

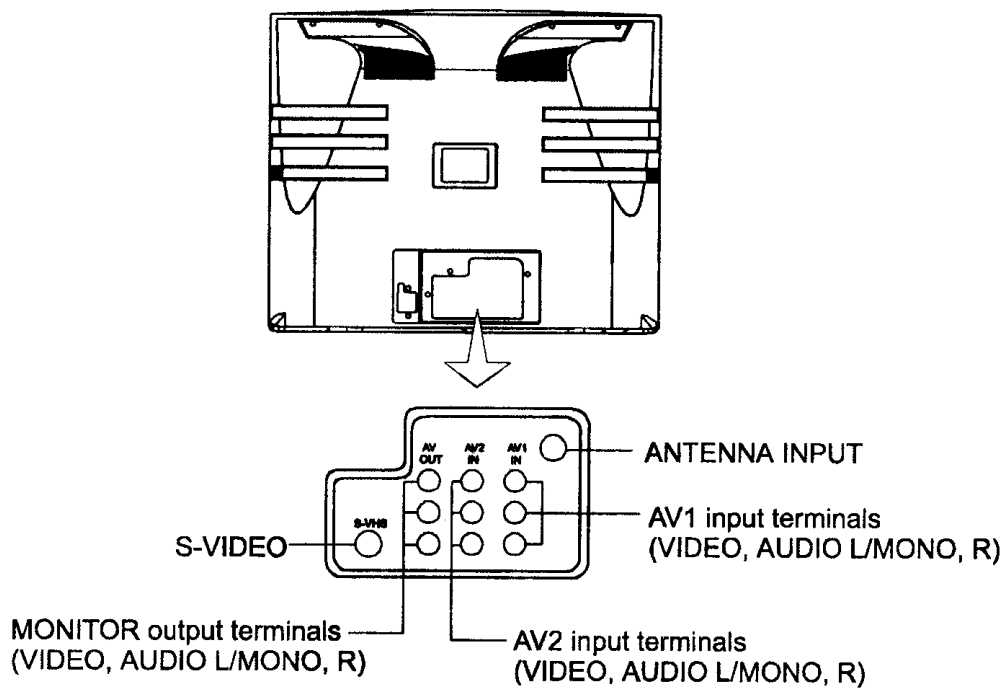

Remote Controller

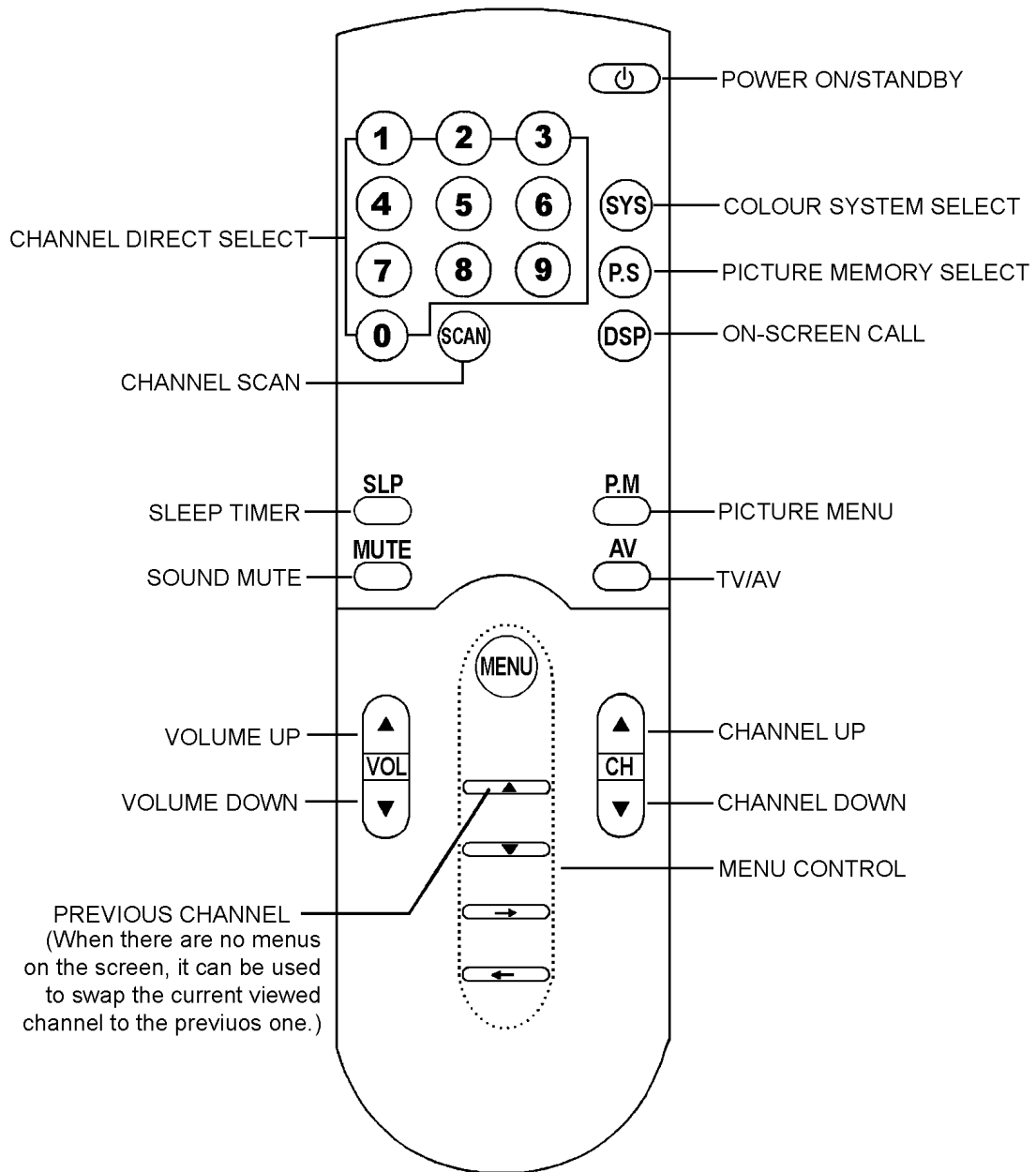

Introducing the menu

You can use the on-screen menus to set the picture quality and other settings. You can use buttons on both the remote controller and the TV to operate the menus.

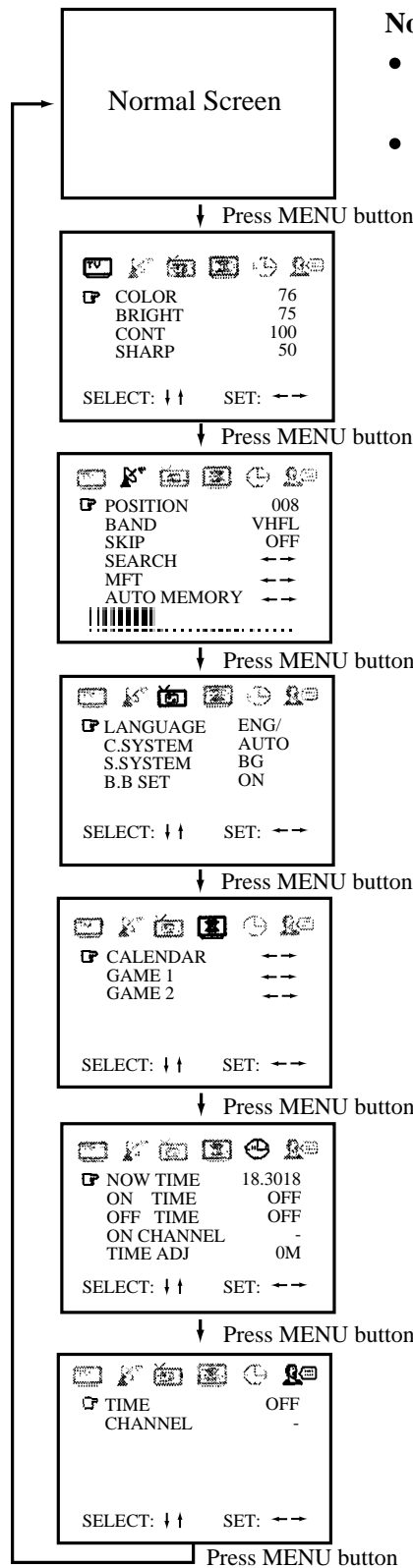

Notes:

- To select each item, use the ▲ or ▼ button.
- To adjust or set each item, use the → or ← button



OPERATION

Turning the Power On/Off

- The following describes how to turn the TV on/off using the TV's main switch and the remote controller.



To turn the power on/off

1. Press the **POWER** switch, the red power indicator lights up.

2.  Press the  button or any one of 0~9 number buttons on the remote controller to turn the set on and the green indicator lights up.
Without using the remote controller, you can directly press **VOL ▲/▼** or **CH ▲/▼** or **TV/AV** button on the set to turn on the TV.

*Note: If there are no input signals to the TV when the TV set is on, a blue background will appear on the screen (when B.B (blue back) is set ON.)
After 15 minutes if there are still no signals to the TV, it will enter into standby mode automatically

3. Press the **POWER** switch to turn off the set completely.

4.  If you want to turn off the TV temporarily, press the  button on the remote controller to switch the set to standby mode.

Note:

To prolong the picture tube's life, us a delayed shut-down circuit is adopted. The  button functions only when the set is turned on for more than 5 seconds.

Special indication:

Auto-Power-Off function: there are two kinds of Auto-Power-Off function:

1. If a vacant channel is tuned or TV broadcast for a day is finished, and the blue background appears on the screen, the TV will automatically turn off after about 15 minutes.
2. Sleep-timer function.
3. OFF timer function

OPERATION

Tuning in

- There are two ways to preset channels: to preset channels automatically and to preset channels manually. Below we will describe how to preset the channels by making use of the menu.

To preset channels (Auto search)

Use the AUTO SEARCH function to preset all the active channels in your local area automatically.

To enter into menu



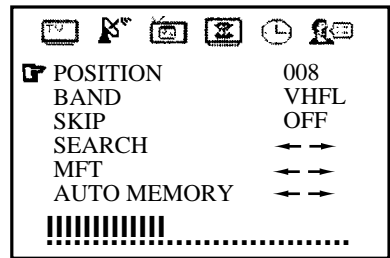

Press the **MENU** button repeatedly to select and highlight the  icon, and the PRESET menu appears on the screen automatically.



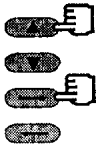

Press the **▲** or **▼** button to select the item upward or downward in the menu, press the **→** or **←** button to enter into the selected item.

Note: If this manual the MENU button refers to the MENU button on the remote controller or on the TV set, the **▲** or **▼** button refers to the **▲** or **▼** button on the remote controller or **CH▲/▼** button on the TV set, the **→** or **←** button refers to the **→** or **←** button on the remote controller or the **VOL+/-** button on the TV set.

AUTO SEARCH

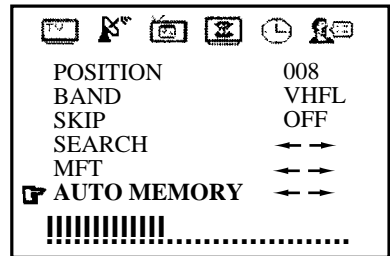
1.  Press the  (PRESET) menu, press the **▲** or **▼** button to select AUTO MEMORY.



2.  Press the **→** button to start the AUTO SEARCH. All active channels will be preset and stored into the memory automatically. After presetting, the TV will return to the first channel program.

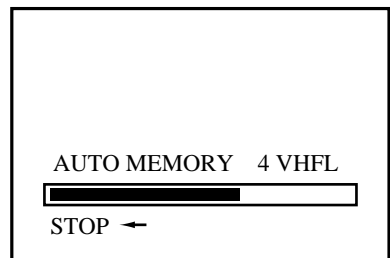

3.  During the process of AUTO SEARCH, pressing the **←** button on the remote controller will stop the process the and TV will return to the first channel program.

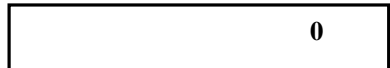

OPERATION







Tuning in (continued)





- Use the MANUAL SEARCH function if desired channels can not be preset with the AUTO SEARCH or if you would like to preset channels to specific position numbers one by one.
- It is convenient to set the channel numbers to the same position numbers using MANUAL SEARCH and SKIP functions.

To preset channels (Manual search)









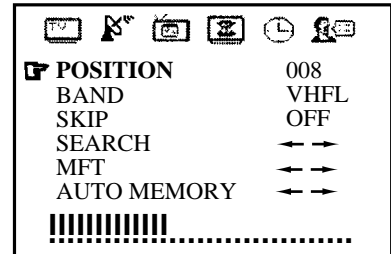



Manual search







If AUTO SEARCH can not preset the desired channels, or you want to preset the desired channels one by one with the preferred channel numbers, please make use of Manual search.

1.  Press the MENU button repeatedly to enter into the  (PRESET) menu, or press the  or  button to select POSITION. Press the  or  button to select a desired position number (from 0~255)

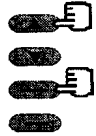







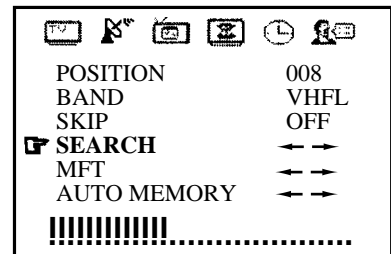



Note: press the  or  button to select a channel number within 0.7 seconds. Press and hold the  or  button for over 0.7 seconds to select a decimal number





					
	POSITION	008			
	BAND	VHFL			
	SKIP	OFF			
	SEARCH				
	MFT				
	AUTO MEMORY				
		!!!!!!!!!!!!!!.....			









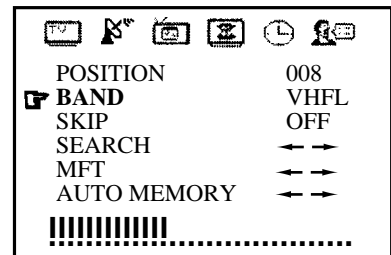



2.  Press the  or  button to select SEARCH. Press the  button to search channels from current channel to higher channel (the screen displays glittering (""). Press the  button to search channels from current channel to lower channel (the screen displays glittering (""). When a channel is located, the searching stops, this channel is then memorized with the preset position number.



					
	POSITION	008			
	BAND	VHFL			
	SKIP	OFF			
	SEARCH				
	MFT				
	AUTO MEMORY				
		!!!!!!!!!!!!!!.....			

Note: you can also make use of BAND selection to quicken the searching process in your desired band. Press the  or  button moves the band to the next step in the sequence below.



					
	POSITION	008			
	BAND	VHFL			
	SKIP	OFF			
	SEARCH				
	MFT				
	AUTO MEMORY				
		!!!!!!!!!!!!!!.....			

3. When you want to store another channel at another position, repeat steps 1 & 2 above.

OPERATION

Tuning in (continued)

The setting of colour system

Note: In factory the TV set's colour system has been preset to AUTO, if you want to change the system, please do the following adjustments.

1.  Press the SYS button, the colour and sound system will be displayed on the screen.

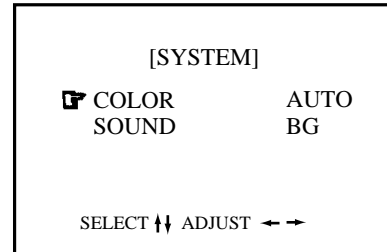

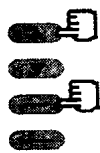
2.  If the colour is abnormal, press the ▲ or ▼ button to select COLOR, then press the → or ← button to select the proper colour system. Every time you press the → or ← button, the colour system will change in the sequence below.

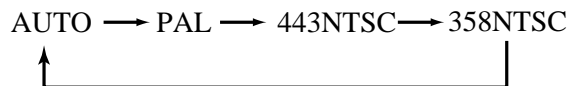
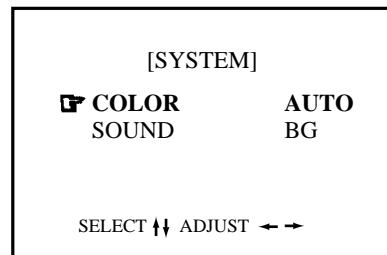

Now you can watch the broadcasting TV program on the preset channels.

OPERATION

Channel selection

- You can watch TV programmes being broadcast on the preset channels.

To watch a TV programme

You can select your desired TV program by one of the following methods.

Using the direct select buttons

- To select a one-digit position number (0~9)**

METHOD 1: Press the button and the screen displays "X- -", wait for 2 seconds and the channel is selected.

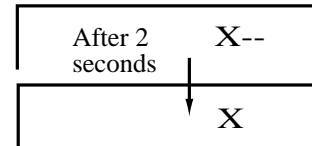

METHOD 2: Press 0 button and the screen displays "0- -", then press 0 button again, the screen displays "00-" then press the numbers. (The period of two-press must be within 2 seconds).

- To select a two-digit position number (10~99)**

METHOD 1: Press these two numbers and the screen displays "XX -", (The period of two-press must be within 2 seconds). Wait for 2 seconds and the channel is selected.

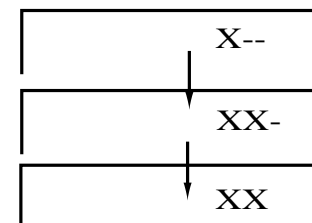

METHOD 2: Press 0 button first, then press these two numbers, the screen displays "0XX", the channel is selected. (The period of two-press must be within 2 seconds).

- To select a three-digit position number (100~255)**

Press these three numbers and the screen displays "XXX" the channel is selected. (The period of two-press must be within 2 seconds).

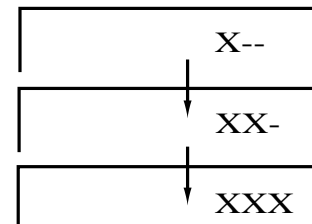

NOTE: If the input number is over 255, the screen will remain at the current viewed program.

Using the CH▲/▼ buttons

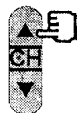

Press CH▼ to select lower position numbers; CH▲ to select higher ones.

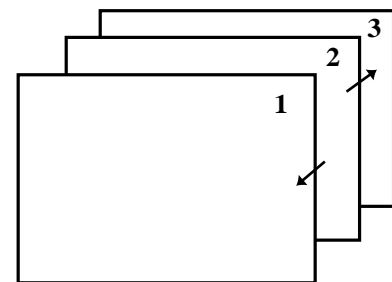

Using the PREVIOUS channel button (▲)



When there are no menus on the screen, pressing the ▲ button on the remote controller (below the MENU button) can swap the current viewed channel with the previous one. For example, the channel you previously watched is 11, the present channel is 2, press the ▲ button, it will return to channel 11, press the ▲ button again it will return to channel 2.

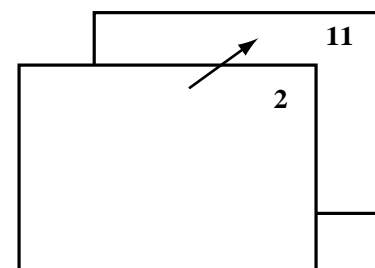

Using the channel SCAN button



Press SCAN button, the set will scan the channels from first channel to higher channels one by one, every program will be displayed for about 3 seconds and then go on scanning until all programs are scanned over and then return to your former viewed program. During the scanning, press SCAN button again, the set will return to your former viewed program.

OPERATION

Convenient Picture Controls

Selectable picture

To select the picture mode



You can select the picture quality instantly among three preset modes and one user-set mode. Press the P.S button to select the desired picture quality.

BRILLIANT, **NATURAL**, **MELLOW** and **PERSONAL** (user-set) can be selected cyclically.

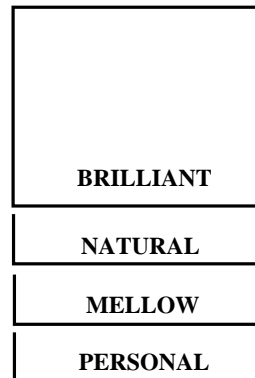

To set the desired picture quality to the PERSONAL position

- Press the MENU button to display the (PICTURE) menu. Or press the P.M button, to call up PICTURE menu.

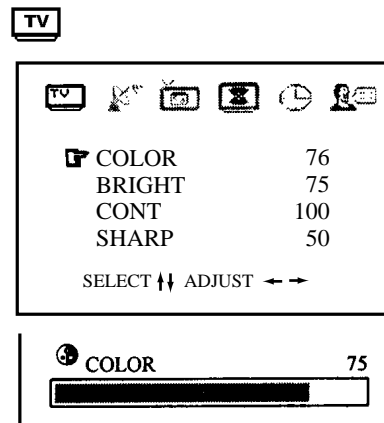

- Press the ▲ or ▼ button to select the desired adjusting item, and press the → or ← button to adjust the level.

Item	Pressing (PERSONAL)		BRILLIANT	NATURAL	MELLOW
	←	→			
COLOR	paler	deeper	75	50	50
BRIGHTNESS	darker	lighter	75	50	50
CONTRAST	weaker	stronger	100	90	70
SHARPNESS	softer	sharper	50	40	30
*TINT	purplish	greenish			

* TINT is for NTSC system only.
The adjusted level is stored in the PERSONAL position.

OPERATION

Convenient Sound Controls and Sleep timer

Adjusting the volume and muting the sound

To adjust the volume



Adjust the volume with the **VOL ▲/▼** buttons.
Press the **VOL ▼** button to decrease the sound.
Press the **VOL ▲** button to increase the sound.

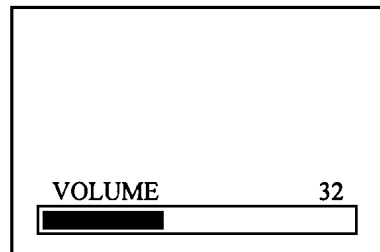

To mute the sound

The muting function is convenient when you need to pay attention to surrounding sounds, answer a phone call, receive a visitor, etc.

1. **MUTE** Press the **MUTE** button to mute the sound.

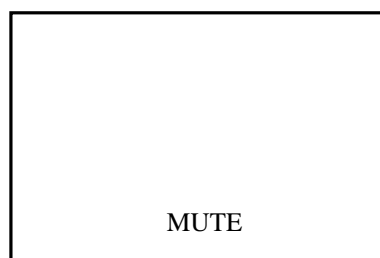

2. To restore the sound, press the **MUTE** button again or **VOL ▲/▼** buttons.

Sleep timer

SLEEP timer

Making use of the Sleep timer function allows you to have the set automatically turned off after a preset time, and the TV set set to standby mode.



Press the SLP button every time, the time displaying on the screen will change in the sequence below:

OFF 120MIN 110MIN..... 10MIN

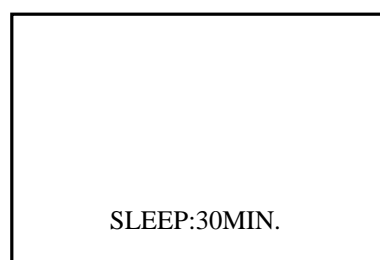

OPERATION

System setting

SYSTEM SET



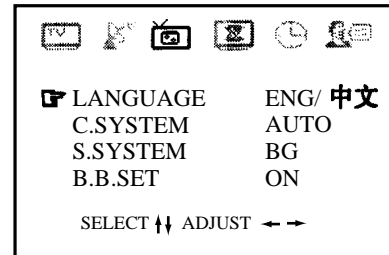

Press the **MENU** button repeatedly to select and highlight the  icon, and the SYSTEM SET menu appears on the screen automatically.

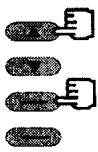

To select the language for the OSD

Making use of this function can switch the language for the OSD to either English or Chinese.



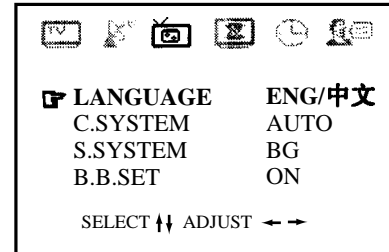

In the  (SYSTEM SET) menu, press the ▲ or ▼ button to select LANGUAGE. Press the → or ← button to select ENGLISH or "中文" (CHINESE).

The selected language is displayed in front and the screen menu is automatically displayed in that language

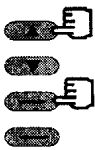

Colour system selection



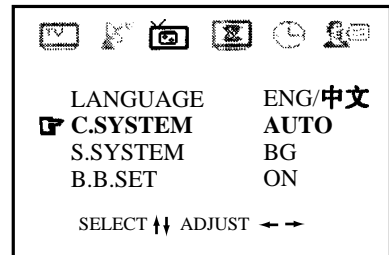

In  (SYSTEM SET) menu, press the ▲ or ▼ button to select C-SYSTEM item. Press the → or ← button to select proper colour system, AUTO, PAL, 443NTSC, 358NTSC can be selected cyclically (refer to setting of colour system on page 11).

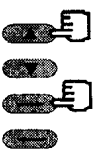

Blue background

With the blue background function ON, the TV will automatically turn blue when no signal is being received.



In  (SYSTEM SET) menu, press the ▲ or ▼ button to select B/B SET. Press the → or ← button to change the blue background setting ON or OFF. To exit the menu, press the MENU button repeatedly or wait for 15 seconds.

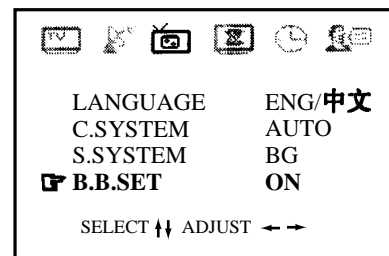





note: If the receiving signals are weak or are not standard, please set the B.B.SET to OFF, otherwise blue back will appear on the screen or the program will be lost.

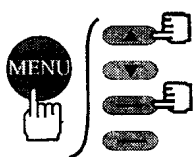

OPERATION

Special functions

CALENDAR function(1800-2200)



Enter into the  (SPECIAL FUNCTION) menu, press the ▲ or ▼ button to select CALENDAR, press the  or  button to enter into calendar interface.

In the calendar interface pressing the ▲ or ▼ button can switch among the year, month and the date while pressing the  or  button can increment or decrement them.

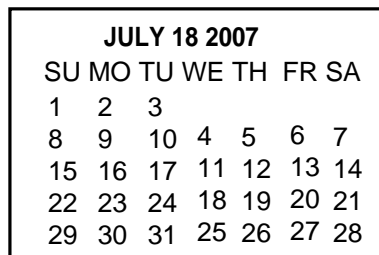
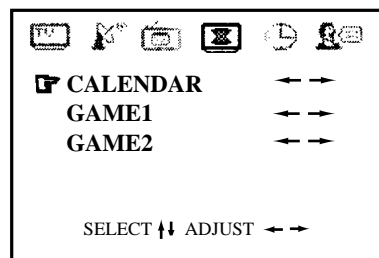

To exit the calendar interface, press any one of the buttons on the remote controller



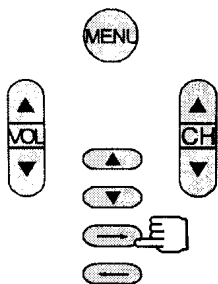

Playing games

To play GAME1 (GOBANG)

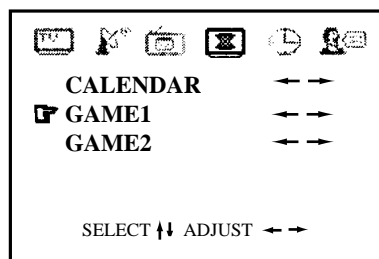

Enter into the  (SPECIAL FUNCTION) menu, press the ▲ or ▼ button to select GAME1 item, press the  or  button to enter GAME1 interface



To play GOBANG, that is, you play chess with the machine, Whoever first fills the chessboard with five continuous chessmen at the same line or diagonal line will win the game. Pressing the ▲, ▼, ,  buttons can move the cursor upward or downward or leftward or rightward. Press the MENU button to confirm the position.

To exit the game, press the VOL ▲/▼ button or the CH ▲/▼ button.

OPERATION

Special functions

Playing games

To play GAME2 (Falling Cube)

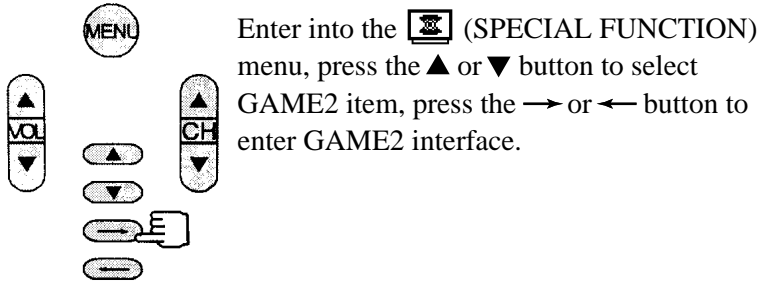

Press any one of ▲, ▼, ←, → buttons to start the game. on the screen, there are falling cubes, pressing ▲ button can change the cubes shape, pressing ←, → buttons can move the cubes leftward or rightward while pressing ▼ button can quicken the falling speed.

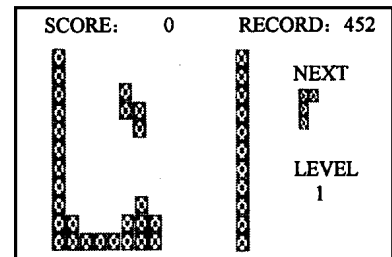
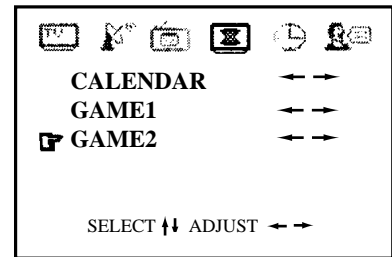

When at the screen's playing area one row has been filled with cubes, the row will disappear, and your score will gain one point. If two rows disappear at the same time, your score will gain three points. If three rows disappear at the same time, you score will gain seven points.

The right window provides hints about next cube's shape, you can arrange current cube's position and angle in advanced. When the cube reach top, the screen will display GAME OVER, and the game is finished.

To exit the game, press the VOL ▲/▼ button or the CH ▲/▼ button.

OPERATION

CLOCK SETTING

CLOCK SET





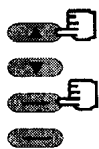

Press the MENU button repeatedly to select and highlight the  icon, and the CLOCK SET menu appears on the screen automatically.

NOW TIME setting

Making use of this function can set the current time for the TV.



In the  (CLOCK SET) menu, press the ▲ or ▼ button to select NOW TIME. Press the → or ← button to set the current time

					
	NOW TIME	18:30:18			
	ON TIME	OFF			
	OFF TIME	OFF			
	ON CHANNEL	--			
	TIME ADJ	0M			
	SELECT	↑↓	ADJUST	←→	

ON TIME setting

Making use of this function can automatically turn on the TV at a preset time.

In the CLOCK SET menu press the ▲ or ▼ button to select ON TIME. Press the → or ← button to set the TV ON time. In standby mode, once the TV ON time is in accordance with the current time, the TV will turn on automatically.

	NOW TIME	18:30:18			
	ON TIME	19:00			
	OFF TIME	OFF			
	ON CHANNEL	000			
	TIME ADJ	0M			
	SELECT	↑↓	ADJUST	←→	

OFF TIME setting

Making use of this function can automatically turn off the TV at a preset time.

In the CLOCK SET menu press the ▲ or ▼ button to select OFF TIME. Press the → or ← button to set the TV OFF time. In standby mode, once the TV OFF time is in accordance with the current time, the TV will turn off automatically and be in standby mode.

	NOW TIME	18:30:18			
	ON TIME	OFF			
	OFF TIME	23:00			
	ON CHANNEL	000			
	TIME ADJ	0M			
	SELECT	↑↓	ADJUST	←→	

ON CHANNEL setting

Making use of this function can automatically turn on the TV at a preset channel

In the CLOCK SET menu press the ▲ or ▼ button to select ON TIME. Press the → or ← button to set the TV ON channel. If the set's turning on is determined by the ON TIME setting, then after turning on, the TV will broadcast the preset channel.

Note:

- 1) To fulfill the ON CHANNEL function, you should set ON TIME first.
- 2) Press the → or ← button to set the time. If you press the button within 0.7 seconds, the minute will increase or decrease by 1; if you press the button for more than 0.7 seconds, the minute will increase or decrease by 20.
- 3) Once the function of ON/OFF TIME has been fulfilled, next when you want to use the function once more you should set them again.

Time adjustment

Making use of this function can adjust the built-in clock.

In the CLOCK SET menu press the ▲ or ▼ button to select TIME ADJ item. Press the → or ← button to adjust the value. If you discover the built-in clock is quicker or slower than standard time, for example, every day it will be quicker for about 10 minutes, then you can set the value to -10 MIN to adjust the clock

	NOW TIME	18:30:22			
	ON TIME	OFF			
	OFF TIME	OFF			
	ON CHANNEL	--			
	TIME ADJ	-10M			
	SELECT	↑↓	ADJUST	←→	

To exit the menu, press the MENU button repeatedly or wait 15 seconds.

OPERATION

Channel reservation

To reserve the channel

Making use of this function can switch the channel to your desired channel you reserve at a preset time.



Press the MENU button repeatedly to select and highlight the  icon, and the RESERVE menu appears on the screen automatically

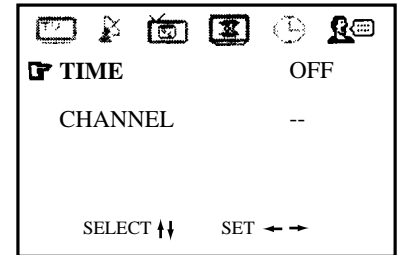

Time setting

Making use of this function to set the time to switch the channel to the reserved channel.

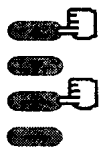

Press the ▲ or ▼ button to select TIME.

Press the → or ← button to set the time.

To exit the menu, press MENU button repeatedly or wait 15 seconds.

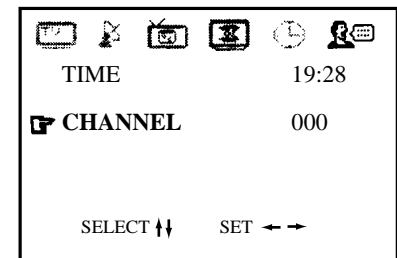

Channel setting

Making use of this function to set the reserved channel.

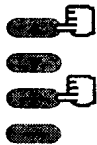

Press the ▲ or ▼ button to select CHANNEL, then press the → or ← button, the channel number.

When the set's current time is in accordance with the time which you set in the  (RESERVE) menu, the set will automatically switch to the reserved channel.

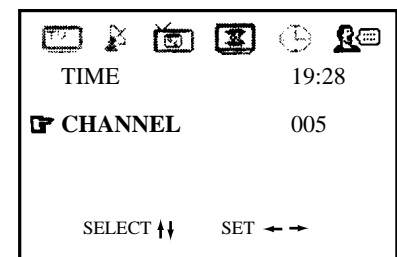

To exit the menu, press the MENU button repeatedly or wait for 15 seconds.

Note:

1. To fulfill the RESERVE function, you should set the time firstly, then set the reserved channel.
2. Once the RESERVE function has been fulfilled, next when you want to use the function once more, you should set them again.

CONNECTING OTHER EQUIPMENT

External Equipment Connections

- The following describes how to use and connect the TV with other AV equipment. Refer to the owner's manual of the equipment to be connected as well.

To connect AV input terminal

You can connect video equipments such as a VTR and video camera to this TV and enjoy the high quality picture and sound.

If your video equipment has a **S-VIDEO** output terminal, connect it to the **S-VIDEO** input terminal (special S-VIDEO type) of the unit. If not, connect it to the **VIDEO** terminal (photo type).

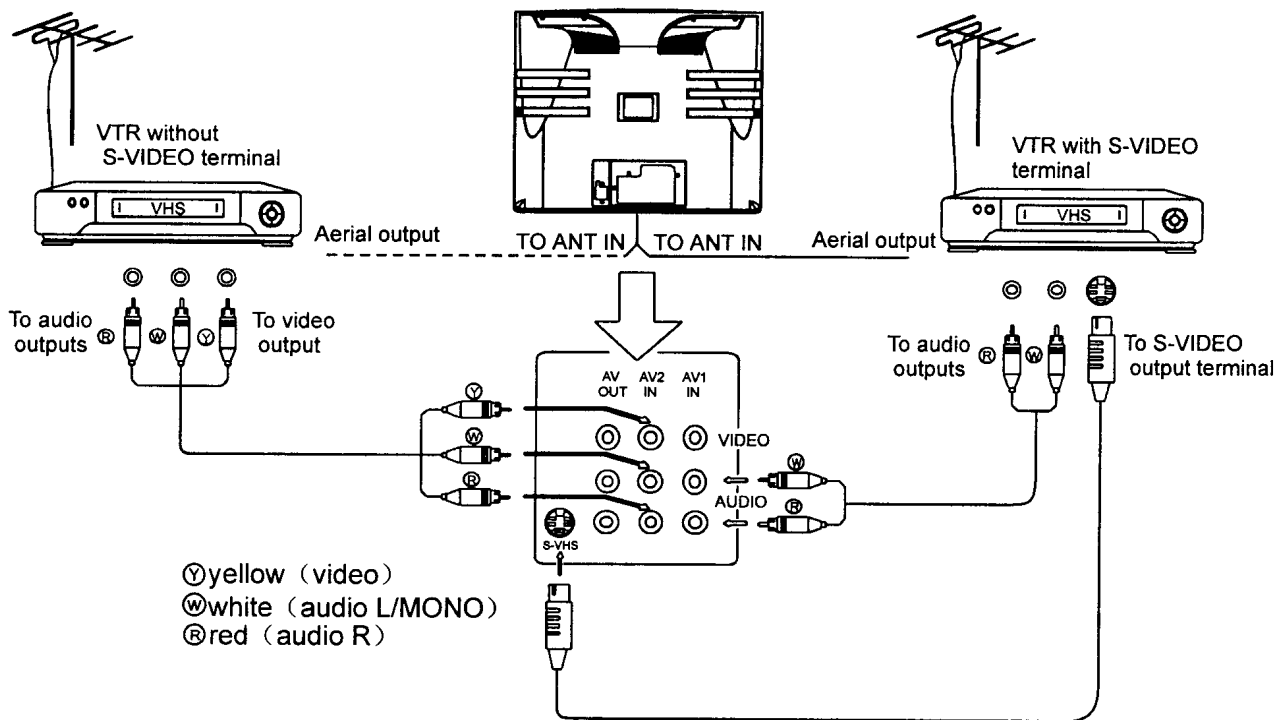

CONNECTING OTHER EQUIPMENT

To connect AV input terminal (continued)

To select the video input, press **TV/AV** the button on the TV set or **AV** button on the remote controller repeatedly until you see the corresponding input indication on the screen. To return to aerial input, press the **AV** button until it displays program number, or press channel select button or the **CH ▲/▼** button.



If the colour of video input is abnormal, the colour system setting may be incorrect. Press the **SYS** button until the **COLOR AUTO** is displayed on the screen. If the picture is still abnormal, press the **→** or **←** button until normal colour appears.

NOTE on the S-VIDEO terminal

The **S-VIDEO** input terminal has priority over Video 1 VIDEO terminal. If **S-VIDEO** input terminal is used, the screen will display "**S-VIDEO1**". Note that **S-VIDEO** input terminal and the Video1 VIDEO terminal can not be used at the same time, otherwise it will cause disorder picture.

To connect MONITOR output terminal

You can connect a stereo system to the **MONITOR** output terminals (photo type) on the set to enjoy a high-quality sound from the stereo system. The **MONITOR** output terminals output the video and audio signals being displayed on the screen.

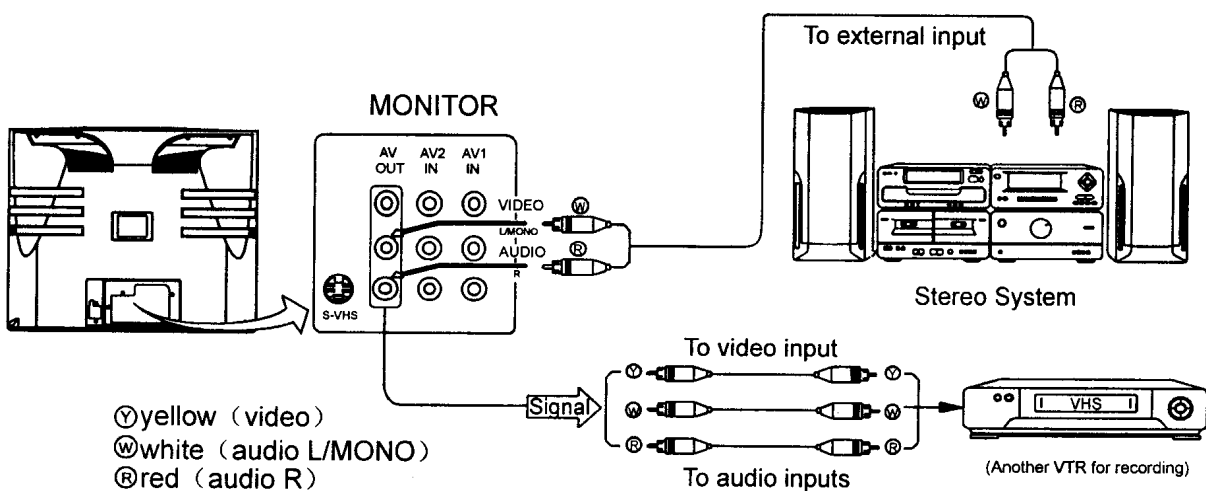

OTHERS

Troubleshooting Guide

- Before calling service personnel, please check the following chart for a possible cause to the trouble you are experiencing.

Symptoms	Check the following items
No power, red indicator is not lit up	<ul style="list-style-type: none">• Be sure the power cord is plugged in.
Poor colour, poor tint	<ul style="list-style-type: none">• Contrast, colour, tint are not correctly adjusted
Spots appear on the screen	<ul style="list-style-type: none">• Possible interferences of automobiles, motorcycle, trolley bus, neon lamps, etc.
Stripes appear on the screen	<ul style="list-style-type: none">• Possible interference of electronic interference from another TV set, a computer, an electronics game machine, a broadcast station, etc.
Double images or "ghosts"	<ul style="list-style-type: none">• This may be caused by reflections from nearby mountains or buildings.• Check the antenna direction.
Snowy picture	<ul style="list-style-type: none">• It is possible that the aerial "lead-in" is damaged or comes off.• Check the antenna direction
The remote controller does not work	<ul style="list-style-type: none">• The batteries may be worn out.• The batteries may be installed with their polarity reversed.
TV cabinet creaks	<ul style="list-style-type: none">• Even if the picture or the sound is normal, changes in the room temperature sometimes make the TV cabinet expand or contract, making a noise. This does not indicate a malfunction.

Specifications

Power supply:	AC 240V, 50Hz		
Power consumption:	120W		
Dimensions (mm):	590 (W) x 526 (H) x 472.5 (D)		
Weight (kg):	35		
CRT	61cm		
TV system & channel range			
System	VHF	UHF	CATV
PAL-B/G	2-12	21-69	X~Z+2, S1~S41
Colour system:	PAL-BG, NTSC 3.58/4.43 (AV)		
Sound output:	6W + 6W		
Accessory:	one remote controller		

* Note: Design and specifications are subject to change without notice.

PALSONIC CORPORATION PTY LTD
1 JOYNTON AVENUE
WATERLOO NSW 2017 AUSTRALIA
TEL:(02)9313 7111
FAX:(02)9313 7555
www.palsonic.com.au

**PALSONIC CUSTOMER SERVICE
TELEPHONE
AUSTRALIA: 1300 657 888**

604-259A3-03

Free Manuals Download Website

<http://myh66.com>

<http://usermanuals.us>

<http://www.somanuals.com>

<http://www.4manuals.cc>

<http://www.manual-lib.com>

<http://www.404manual.com>

<http://www.luxmanual.com>

<http://aubethermostatmanual.com>

Golf course search by state

<http://golfingnear.com>

Email search by domain

<http://emailbydomain.com>

Auto manuals search

<http://auto.somanuals.com>

TV manuals search

<http://tv.somanuals.com>