

OWNER'S MANUAL

Palsonic

68CM CORDLESS REMOTE COLOUR TELEVISION
MODEL: 6825G



Type Tested
Electrical
Safety

AS/NZS 3250 Lic 4166
Standards Australia
APP No: N15899

PALSONIC CORPORATION PTY LTD
1 JOYNTON AVENUE
WATERLOO NSW 2017 AUSTRALIA
TEL:(02)9313 7111
FAX:(02)9313 7555
www.palsonic.com.au

**PALSONIC CUSTOMER SERVICE
TELEPHONE
AUSTRALIA:1300 657 888**

Contents

Contents

Congratulations on your purchase of this **Palsonic** colour television receiver. We recommend that you thoroughly read this manual before use to fully enjoy the many functions and excellent effects of this receiver.

Retain this manual in an easily accessible location for future reference.

Note: Screen displays and illustrations in this manual may differ from the actual ones for better visibility.

CONTENTS

Features	1
Important Safety Cautions	2
Identification of Controls	4
Installation	8
Turning On/Off	11
Select Input Signal	12
Tuning In	13
Channel Selection	16
Adjusting Picture	17
Sound Control	18
Timer Setting.....	20
System Setting.....	22
Other FunctionsS	24
Troubleshooting Guide	27
Specifications	28

- ▶ **Hyperband**
- ▶ **Intellectualized I²C bus control**
- ▶ **256 preset channels**
- ▶ **Full function remote control**
- ▶ **AV input & output terminals, DVD input terminals**
- ▶ **Intellectualized remote controller caller**
- ▶ **Automatic channel preset**
- ▶ **Clock/Game/Calendar**
- ▶ **ON timer/OFF timer**
- ▶ **Channel Exchange**
- ▶ **Selectable picture and selectable sound**

Important Safety Cautions

Safety Cautions

- 1 When any unusual situation occurs, turn off the power supply at once and remove the plug from the wall outlet. Contact a qualified service department in your local area.

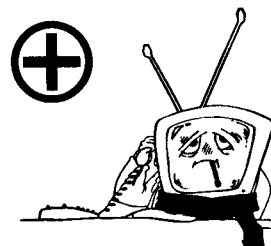

- 2 Do not expose the TV set to rain or excessive moisture. Avoid using the set in very warm or damp places and never use it in a bathroom.

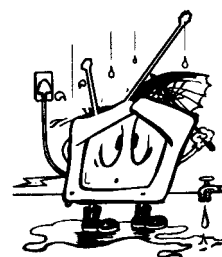

- 3 When cleaning dust off the picture tube disconnect the power first. You can wipe lightly with a piece of dry, clean and soft cloth.

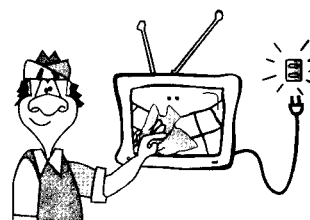

- 4 Avoid exposing the set to direct sunlight and other sources of heat to prevent damage to the cabinet and components.

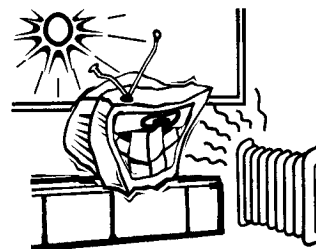

- ⚠ This TV set can operate on an AC power of 240V, 50HZ. You must not use a power supply of any other type.

- 5 High voltage exists in this TV set. Do not remove the cover

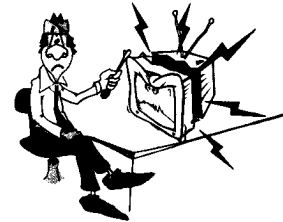

- 6 Do not cover the ventilating hole in the cabinet. Keep a space of more than 5cm from the walls to the TV set to ensure adequate ventilation.

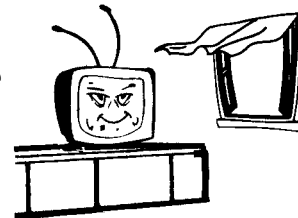

- 7 If the power cord or the plug is damaged contact a qualified service department for service.

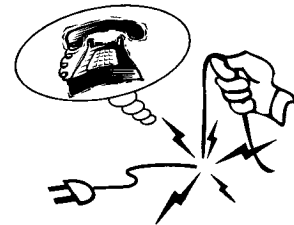

- 8 When the TV set is to be left unattended for a long period of time, turn off the power supply and remove the plug from the wall outlet.

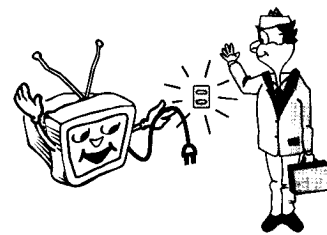

Identification of Controls

Front

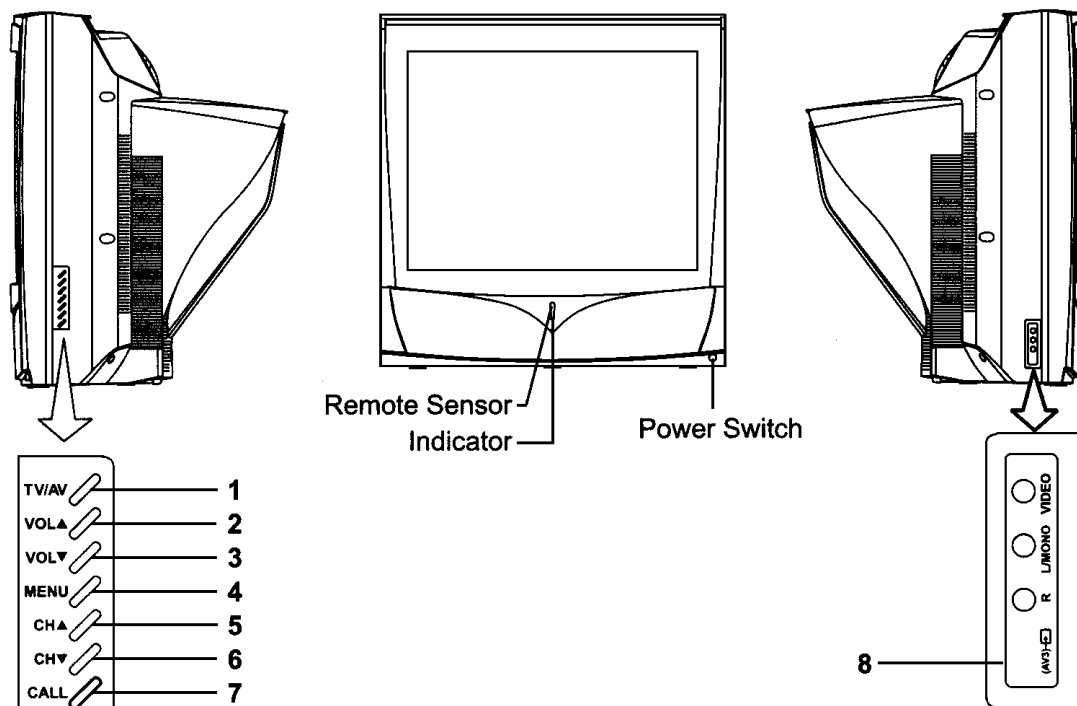

1. TV/VIDEO input select.
2. Volume up; menu item adjust.
3. Volume down; menu item adjust.
4. To enter menu operation.
5. Channel up; menu item select.
6. Channel down; menu item select.
7. To call remote controller.
8. AV3 inputs (VIDEO, AUDIO L/MONO, R)

Back

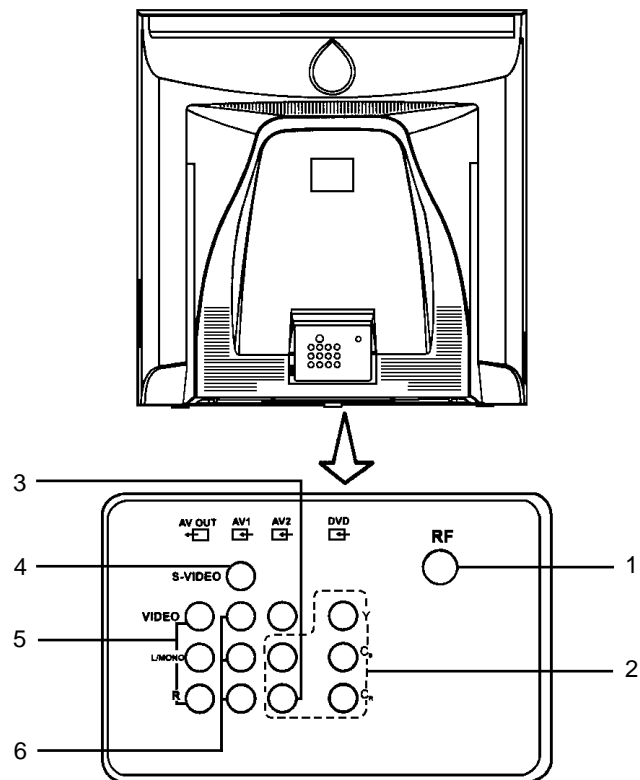

1. Antenna input.
2. DVD inputs (VIDEO: Y, C_B, C_R, AUDIO L/MONO, R).
3. AV 2 inputs (VIDEO, AUDIO L/MONO, R).
4. S-VIDEO input.
5. AV outputs (VIDEO, AUDIO L/MONO, R).
6. AV 1 inputs (VIDEO, AUDIO L/MONO, R).

Identification of Controls (continued)

Remote Controller

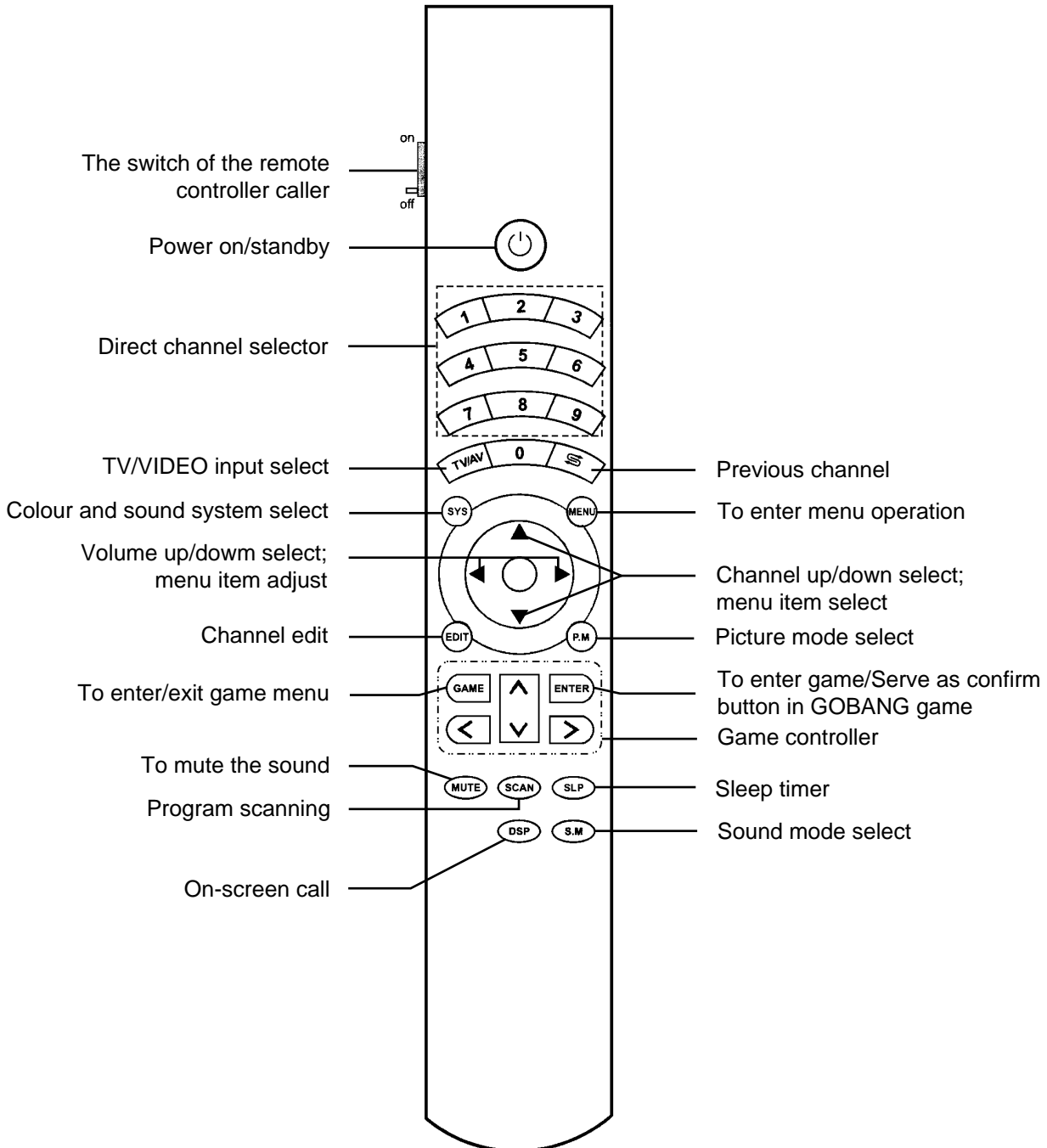

Installing batteries

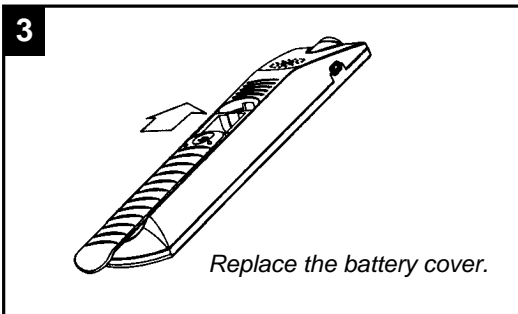
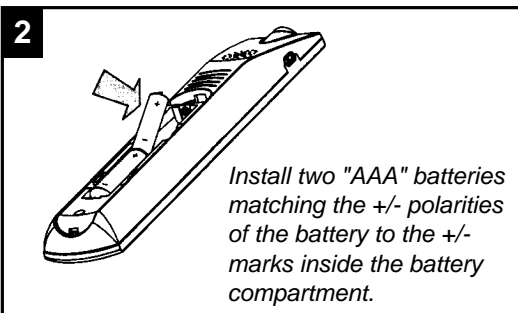
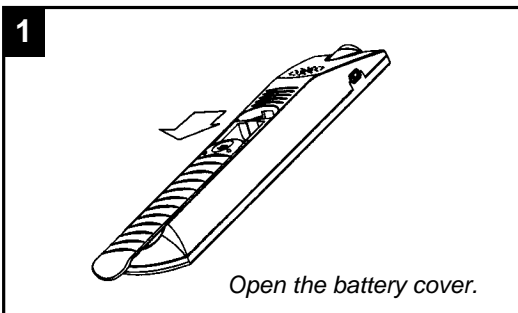

! Notes:

- ▣ The battery life should be about one year under normal use. Do not try to recharge batteries not intended to be recharged.
- ▣ Use only the size and type of batteries specified. Do not mix different types of batteries together or old batteries with fresh ones.
- ▣ When the remote control will not be used for a long period of time or when the batteries are worn out, remove the batteries.
- ▣ Do not throw the batteries into a fire. Dispose of used batteries in the specified manner.
- ▣ Do not drop, dampen or disassemble the remote control.

Effective range of the Remote

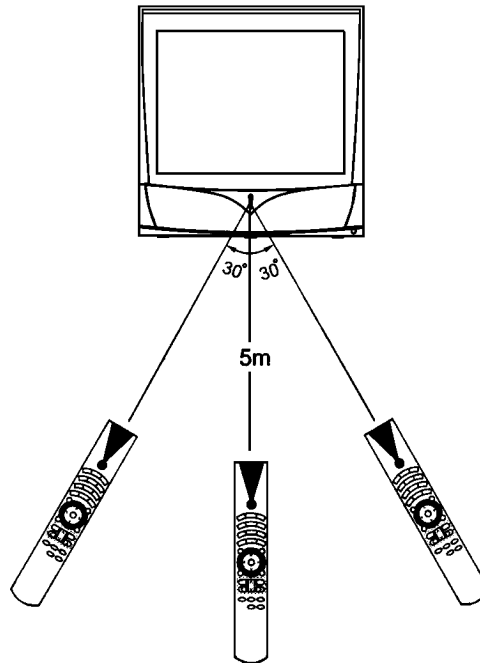

! Notes:

- ▣ When there is an obstacle between the TV and the transmitter, the transmitter may not operate.
- ▣ When direct sunlight, and incandescent lamp, fluorescent lamp or any other strong light shines on the REMOTE SENSOR of the TV the remote operation may be unstable.

Installation

INSTALL the unit in a room where direct light will not fall upon the screen. Total darkness or a reflection on the picture screen may cause eyestrain. Soft and indirect lighting is recommended for comfortable viewing.

Antenna installation

Optimum reception of colour requires a good signal and will generally mean that an outdoor aerial must be used. The exact type and position of the aerial will depend upon your particular area.

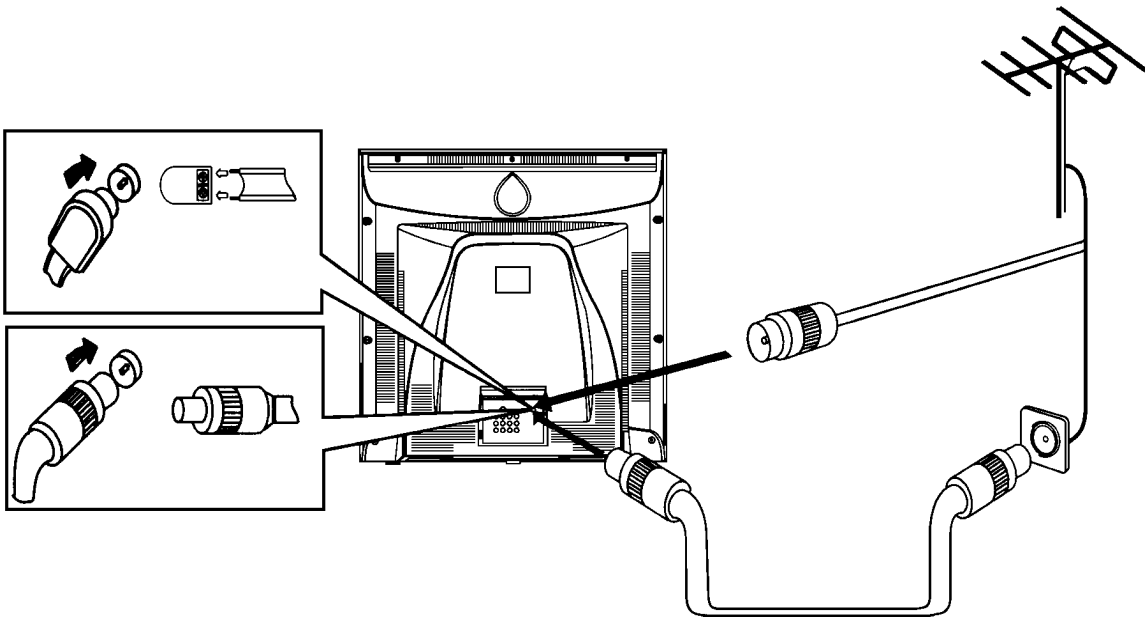

! Notes:

- It is recommended that the 75-ohm coaxial cable be used to eliminate interference and noise which may occur due to radio wave conditions.
- The aerial cable should not be bundled with the power cord and the like.

This TV set provides 3 groups of AV input (including one group of DVD inputs) and 1 group of AV outputs for your convenient connection to VTR, DVD or video camera to enjoy the high quality picture. Please refer to the owner's manual of the equipment to be connected as well.

Using AV Inputs

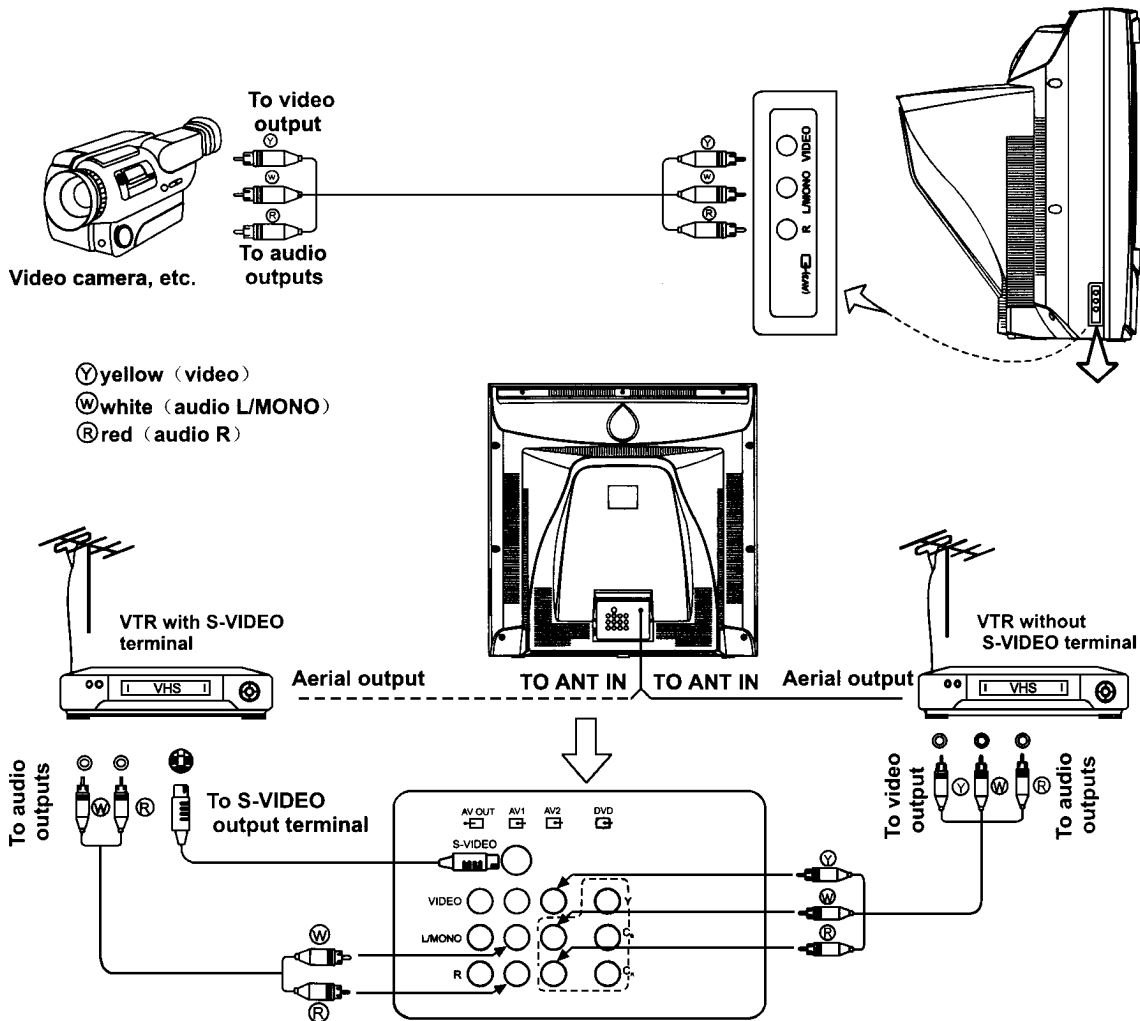

! Notes:

In AV1 inputs, the S-VIDEO terminal is prior to the VIDEO1 terminal. When both S-VIDEO and video signals are input, the S-VIDEO signal is selected. To view a video signal, disconnect the S-VIDEO connection.

The AV2 inputs and the DVD inputs use the same audio terminals. When both DVD and video signal are input, the DVD inputs are prior to VIDEO2 terminal and DVD signal is selected. To view video signal, disconnect Y /C_B/C_R connection,

Installation (continued)

Using DVD inputs

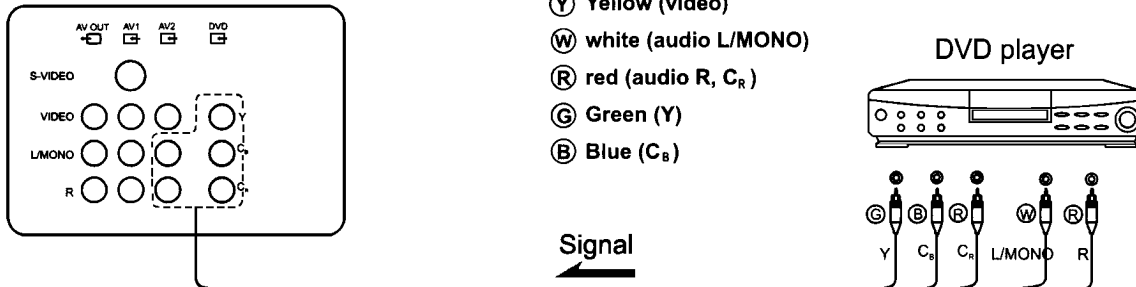

Using AV outputs

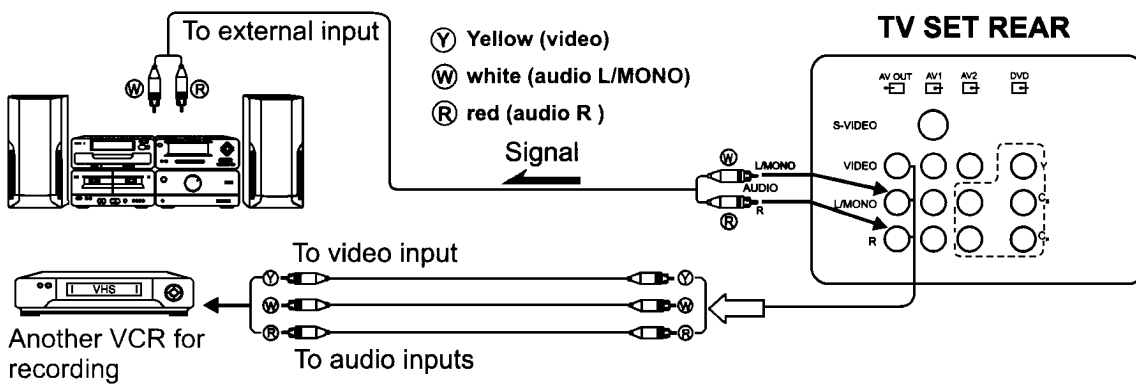

Turning on/off

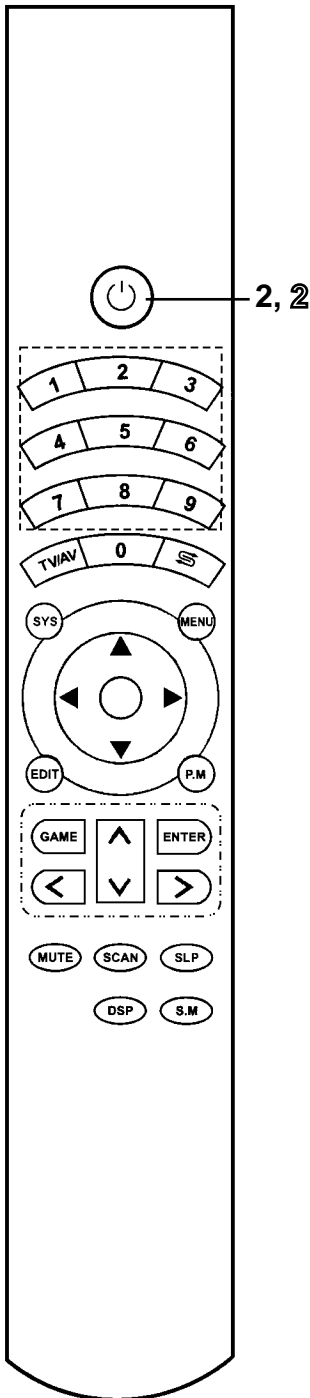

Turning on

1 Press the Power Switch on the TV set.

The TV set is in STANDBY and the Yellow indicator lights up.

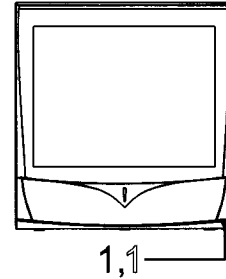

2 In STANDBY mode, press the ⏻ button or 0-9 buttons on the remote controller and the TV set is turned on.

3 In STANDBY mode, you can also press the VOL ▲/▼, CH ▲/▼ or TV/AV button on the set to turn on.

! Notes:

If there is no input signal, then a blueback appears. After 15 minutes, the set auto goes to STANDBY.

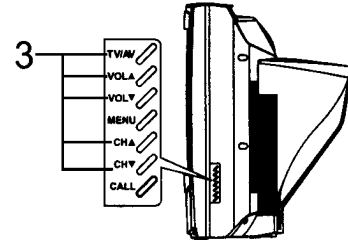

Turning off

1 Press the Power Switch on the TV set if you want to cut off the power completely.

2 If you want to turn off the TV set temporarily, press the ⏻ button on the remote controller.

Select Input Signal

Watching AV program

- 1 To watch video program from AV input, PressTV/AV button repeatedly until you see the appropriate input indicator on the screen

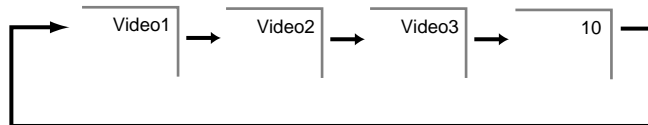

! Notes:

In AV1 inputs, the S-VIDEO terminal is prior to the VIDEO1 terminals. When both S-video and video signal are input, the S-video signal is selected (the OSD is "S-VIDEO1"). To view a video signal, disconnect the S-VIDEO connection.

The AV2 inputs and the DVD inputs use the same audio terminals. When both DVD and video signal are input, the DVD inputs are prior to VIDEO2 terminals and the DVD signal is selected (the OSD is "DVD"). To view a video signal, disconnect Y/C_B/C_R connection.

Switching from AV to TV

- 1 Press TV/TV button repeatedly until the TV program appears.
- 2 Press digit buttons to switch back to TV mode.
- 3 Press CH+ or CH- button to switch back to TV mode.
- 4 Press  button to switch back to TV mode.

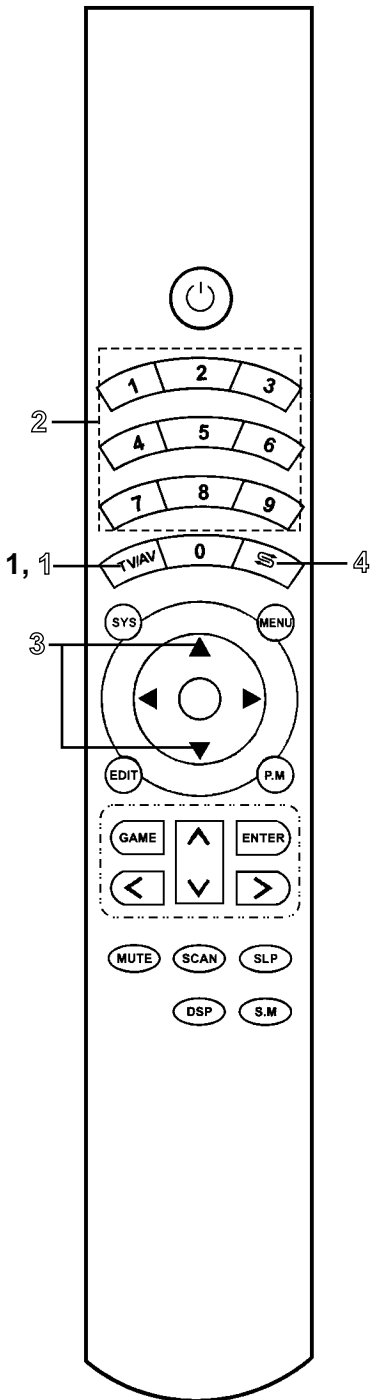

Tuning in

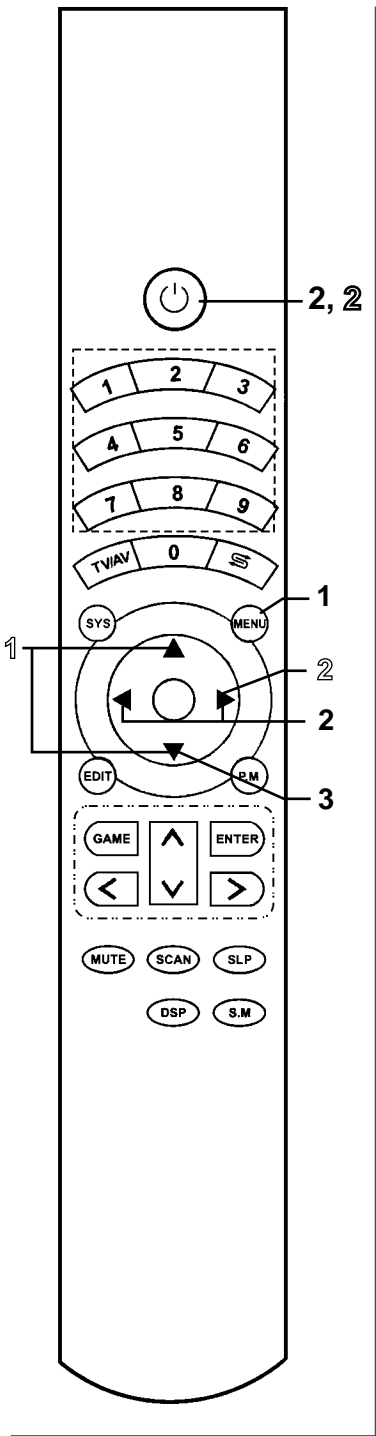

To enter the SEARCH menu

- 1 Press MENU button.
- 2 Press VOL+ or VOL- button to select SEARCH icon.
- 3 Press CH- button to display the Search menu.

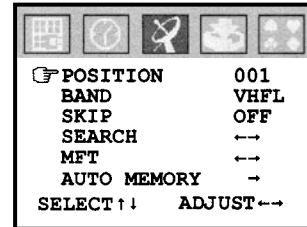

Auto Search

Please enter the **SEARCH** menu first

- 1 Press CH+ or CH- button to select **AUTO MEMORY** item.
- 2 Press VOL+ button to start **AUTO MEMORY**.

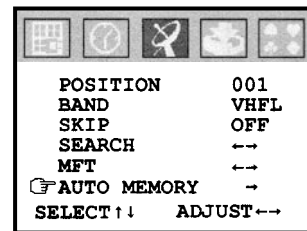

All active channels will be preset and stored into the memory automatically. After presetting, the TV will stop at the first channel program.

! Notes:

During the process of **AUTO MEMORY**, pressing the **VOL-** button will stop the process and go to the first channel.

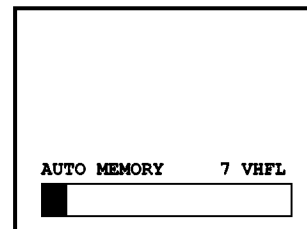

Tuning in (continued)

Manual Search

Please enter the **SEARCH** menu first

Use MANUAL SEARCH function if desired channels cannot be preset or if you would like to preset channels to specific position numbers one by one

POSITION	001
BAND	VHFL
SKIP	OFF
SEARCH	↔
MFT	↔
AUTO MEMORY	-
SELECT ↑↓	ADJUST ↔

- 1** Press CH+ or CH- button to select **POSITION** item.
- 2** Press VOL+ or VOL- buttons to select a channel number (ranging from 000~255).
- 3** Press CH+ or CH- button to select **SEARCH** item.
- 4** Press VOL+ or VOL- button to start program search manually.

Pressing **VOL+**, the set searches towards higher frequency;
Pressing **VOL-**, the set searches towards lower frequency;
The search stops when a program is located and this program will be stored in the specified position number.

! Notes:

1. You can use **BAND** selection to quicken search process if you know which band your desired program locates in. The band switches among **VHFL**, **VHFH** and **UHF**.
2. Repeat the above steps if you want to store another program in other position numbers

To skip an unnecessary channel

- 1** Press CH+ or CH- button to select **POSITION** item.
- 2** Press VOL+ or VOL- button to select a channel number, for example, channel 009.
- 3** Press CH+ or CH- button to select **SKIP** item.
- 4** Press VOL+ or VOL- button to select **ON**.

Now channel 9 will be skipped when you browse by CH+ or CH- button.

POSITION	009
BAND	VHFL
SKIP	ON
SEARCH	↔
MFT	↔
AUTO MEMORY	-
SELECT ↑↓	ADJUST ↔

To restore a skipped channel, please select channel by step 1, 2 then repeat step 3 and 4 and set **SKIP** item to **OFF**.

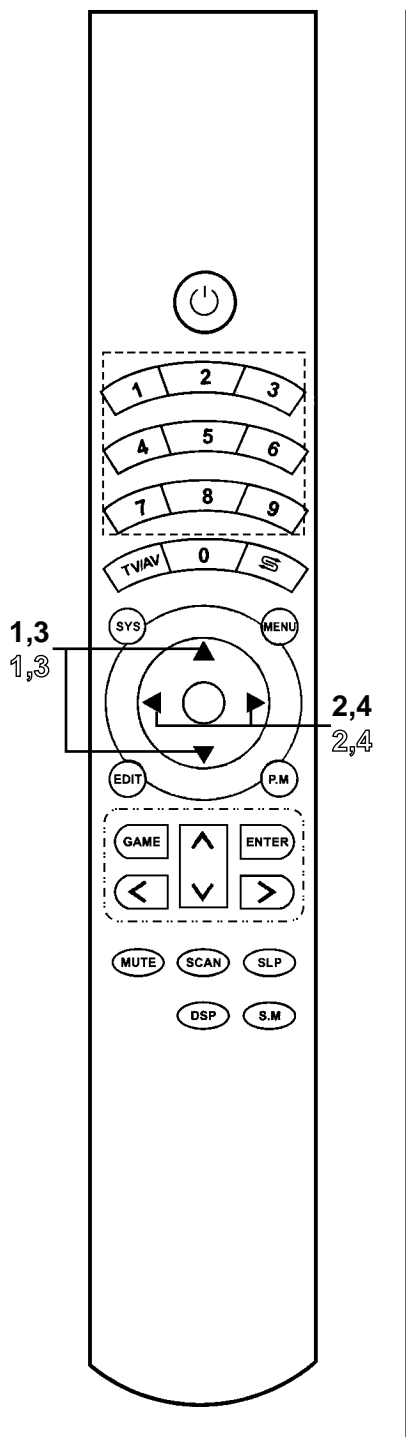

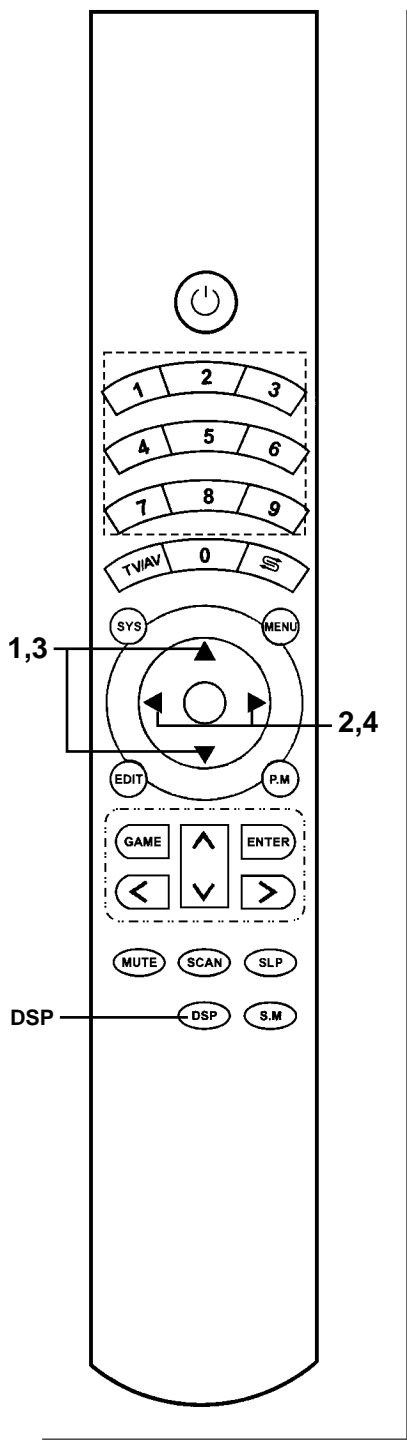

Fine tuning

Please enter the **SEARCH** menu first

Fine tuning is not necessary under normal conditions. However, in area of inferior broadcast conditions where adjustment is necessary for better picture and sound, use Fine tuning.

POSITION	001			
BAND	VHFL			
SKIP	OFF			
SEARCH	---			
MFT	---			
AUTO MEMORY	-			
SELECT ↑↓	ADJUST ←→			

- 1** Press CH+ or CH- button to select POSITION item.
- 2** Press VOL+ or VOL- buttons to select a channel number you want to fine-tune (for example, channel 99).
- 3** Press CH+ or CH- button to select MFT item.
- 4** Press and hold VOL+ or VOL- button till the best possible picture and sound are obtained.

Calling the on-screen display

You can call the on-screen display by pressing the DSP button on the remote control. The first press of the DSP button display the current state (if in TV mode, the current channel number will display) and the next press display the clock time. Press this button again to cancel the OSD.

Channel Selection

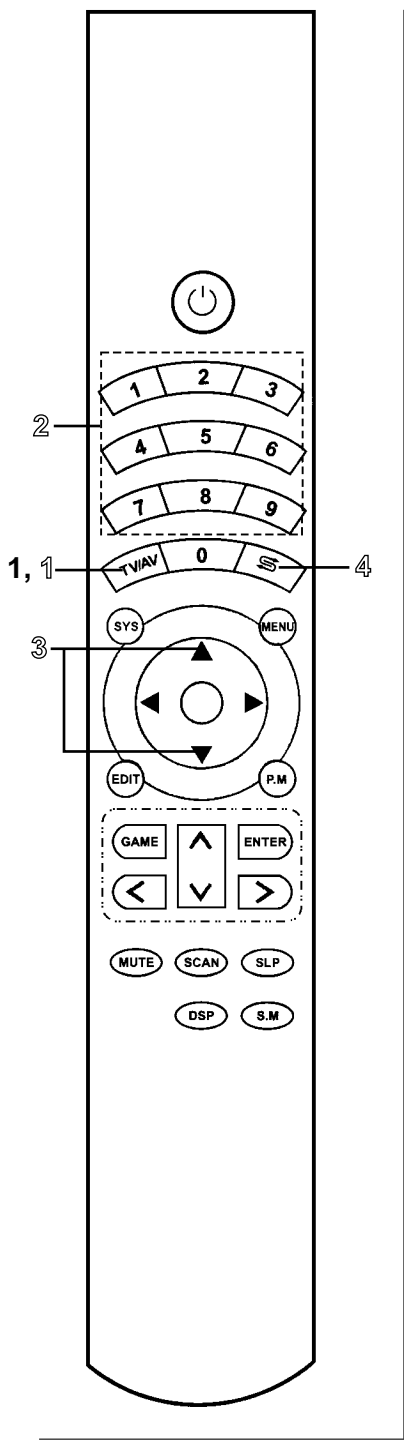

1 Using 0-9 direct channel selector

To select one-digit channel

There are 3 ways for you to select an one-digit channel number, for example, channel 9 as follows.

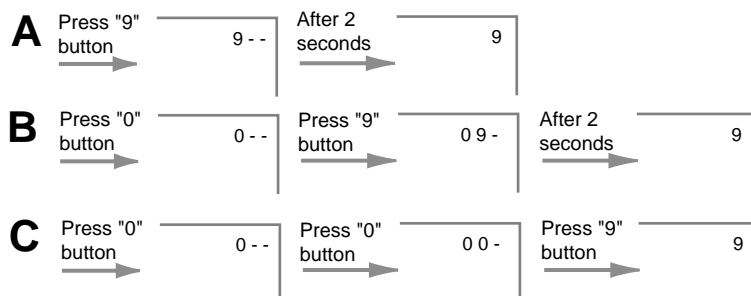

To select two-digit channel

There are 2 ways for you to select a two-digit channel number, for example, channel 19 as follows

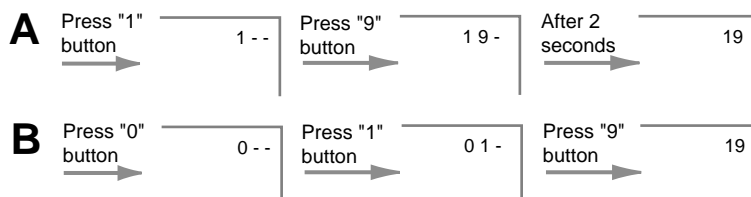

To select three-digit channel

To select a three-digit channel number, for example, channel 199, you just input the channel number on by one. **Be sure that the period of two-press channel should be within 2 seconds.**

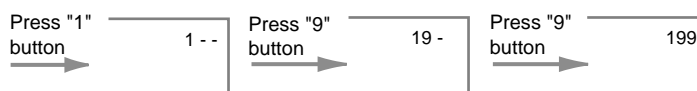

2 Using CH+ or CH- button

Press **CH+** button, the channel number increases;
Press **CH-** button, the channel number decreases.

3 Using previous channel S button

Press this button to switch between the current channel and previous channel.

Adjusting Picture

Adjusting picture

- 1 Press MENU button.
- 2 Press VOL+ or VOL- button to select PICTURE icon.
- 3 Press CH- button to display the PICTURE menu.
- 4 Press CH+ or CH- button to select item.
- 5 Press VOL+ or VOL- button to adjust.

⌂	COLOR	75
	BRIGHT	75
	CONT	100
	SHARP	50
	B . B	ON
SELECT ↑ ↓		ADJUST ← →

Picture mode

- 5 Press VOL+ or VOL- button to adjust.

Item	Picture mode			PERSONAL	
	BRILLIANT	STANDARD	SOFTNESS	VOL -	VOL +
Color	75	50	50	paler	deeper
Brightness	75	50	50	darker	lighter
Contrast	100	90	70	weaker	stronger
Sharpness	50	40	30	softer	sharper
Tint				purplish	greenish

* Note: The item **TINT** is for NTSC only.

The adjusted setting are stored in the **PERSONAL** mode.

There are three preset picture modes and one user-set picture mode. Press **P.M** button to select a picture mode according to you favourites.

- 6 Press P.M button to select picture mode.

Setting blue background

- 1 Enter the PICTURE menu according to the above steps 1-3.
- 2 Press CHL+ or CH- button to select B.B item.
- 3 Press VOL+ or VOL- button to select ON or OFF.

⌂	COLOR	75
	BRIGHT	75
	CONT	100
	SHARP	50
⌂	B . B	ON
SELECT ↑ ↓		ADJUST ← →

If the **B.B** item is set **ON**, the TV set will display a blue background when there is no input signal.

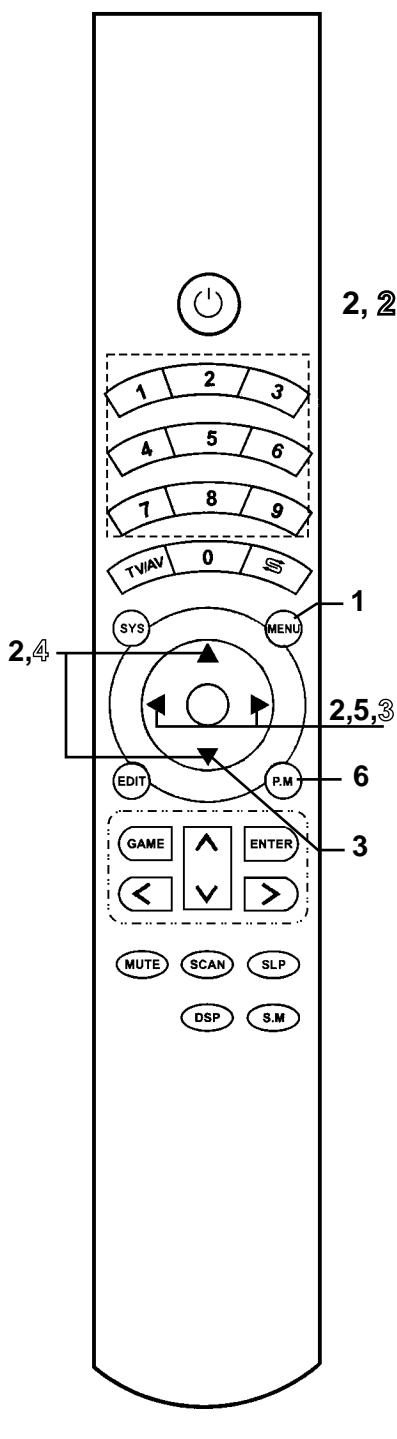

Sound Control

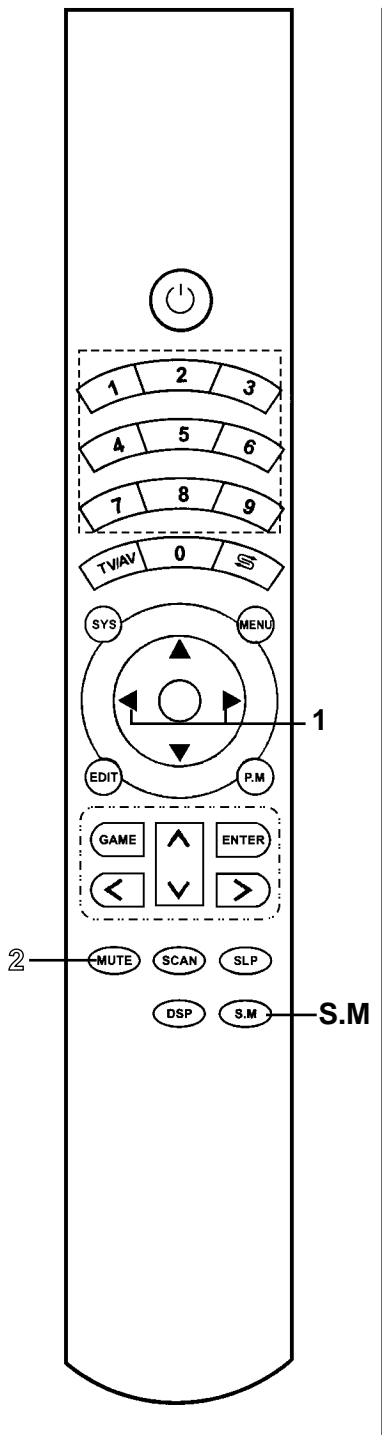

Adjusting volume

1 Use VOL+ or VOL- button.

Press **VOL+** button, the volume increases;
Press **VOL-** button, the volume decreases.

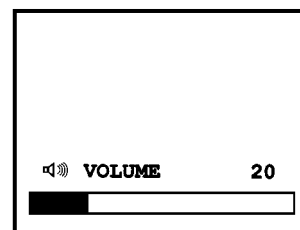

2 Use MUTE button.

If you want to mute the sound, press
MUTE button on the remote.

To resume the sound, press this button
again.

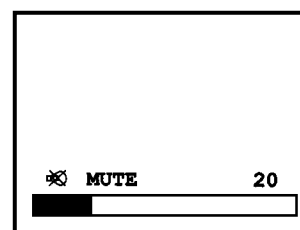

! Notes:

You can also resume the sound by pressing **VOL+** or **VOL-** button.

Selecting sound mode

You can quickly select sound mode by
pressing S.M button.

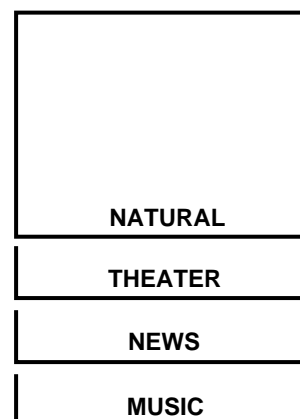

Setting WOOFER

- 1 Press MENU button.
- 2 Press VOL+ or VOL- buttons to select SETTING icon.
- 3 Press CH- button to display the SETTING menu.
- 4 Press CH+ or CH- button to select WOOFER item.
- 5 Press VOL+ or VOL- button to select ON or OFF.

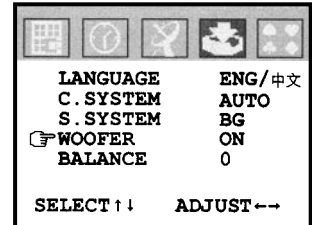

Setting BALANCE

- 1 Enter the SETTING menu according to the above steps 1-3.
- 2 Press CH+ or CH- button to select BALANCE item.
- 3 Press VOL+ or VOL- button to adjust.

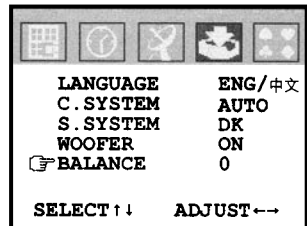

Press **VOL+** button, to decrease the left sound channel;
 Press **VOL-** button, to decrease the right sound channel.

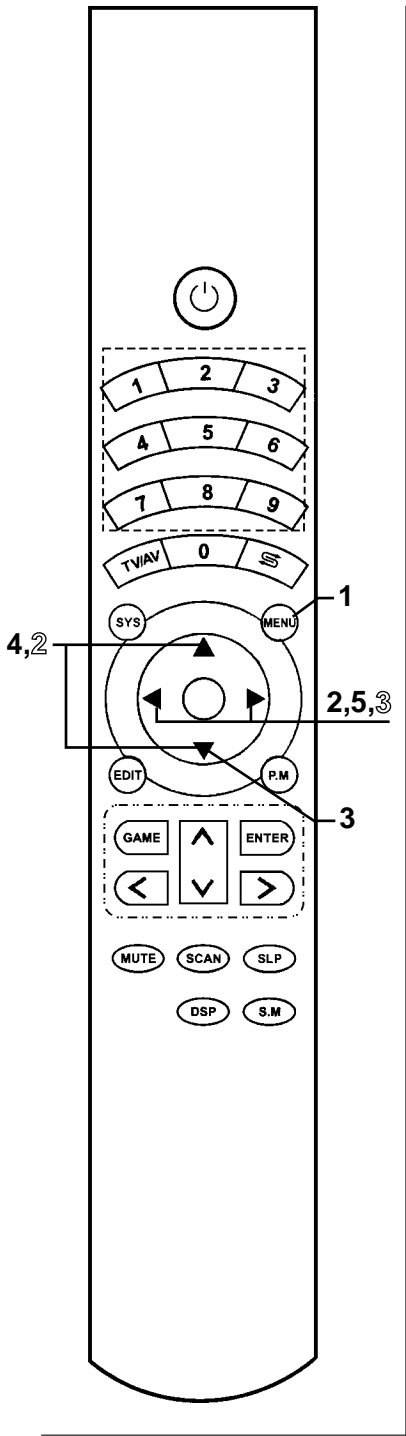

Timer Setting

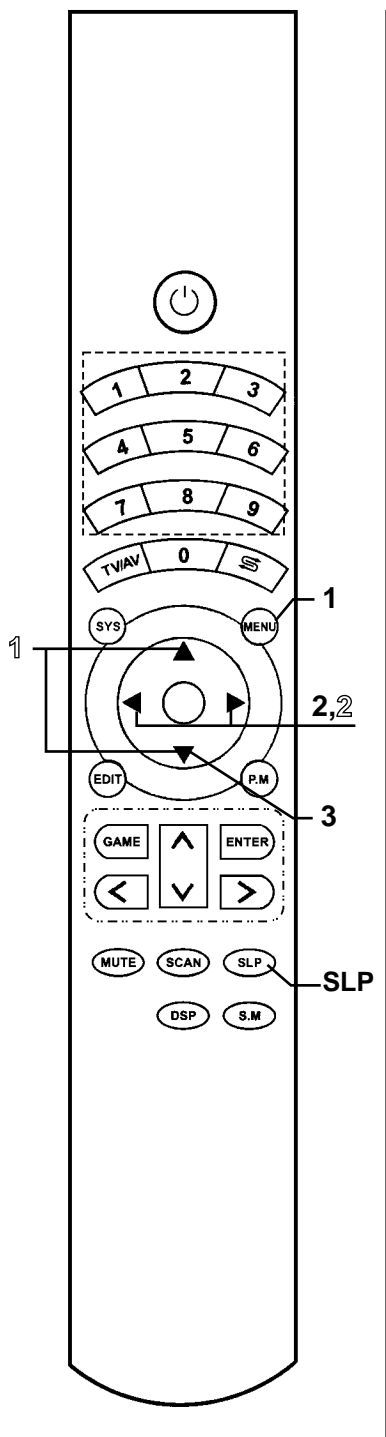

To enter the TIMER menu

- 1 Press MENU button.
- 2 Press VOL+ or VOL- buttons to select TIMER icon.
- 3 Press CH- button to display the TIMER menu.

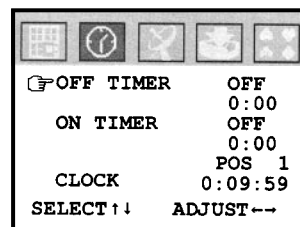

Setting CLOCK

Please enter the **TIMER** menu first.

- 1 Press CH+ or CH- button to select **CLOCK** item.

- 2 Press VOL+ or VOL- button to set current time.

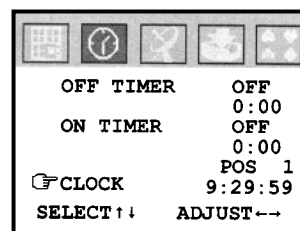

Setting sleep timer

You can quickly set the sleep timer by using the **SLP** button on the remote controller. With every press of this button the sleep time changes as follows;

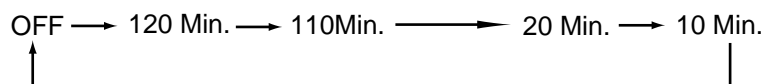

For example, you would like the TV to auto turn off in 60 minutes, you can press the SLP button repeatedly till the screen displays as the right figure.

If you want to cancel the sleep timer, you can press the **SLP** button repeatedly till "OFF" displays on the screen.

SLEEP : 60MIN.

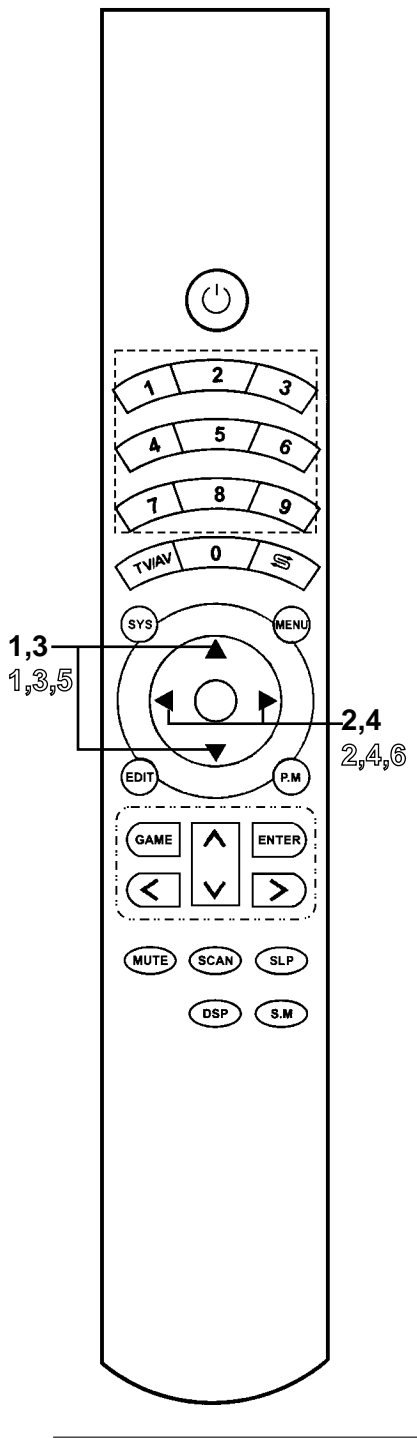

Setting OFF TIMER

Please enter the **TIMER** menu first.

- 1** Press CH+ or CH- button to select **OFF TIMER** item.
- 2** Press VOL+ or VOL- button to select **ONCE** or **EVERY**.
- 3** Press CH- button.
- 4** Press VOL+ or VOL- button to set the **OFF** time, for example **22:00**.

OFF TIMER	EVERY
	22:00
ON TIMER	OFF
	0:00
	POS 1
CLOCK	0:09:59
SELECT ↑↓	ADJUST ←→

The set auto turns off when the time is 22:00. If you set the **OFF TIMER** item to **ONCE**, this function only effects once; if you set the **OFF TIMER** item to **EVERY**, this function effects every day. To cancel this function, please set the **OFF TIMER** to **OFF**.

! Notes:

The Time can not be accessed until you set the **Off Time** to **Once** or **Every**.

Setting ON TIMER

Please enter the **TIMER** menu first.

- 1** Press CH+ or CH- button to select **ON TIMER** item.
- 2** Press VOL+ or VOL- button to select **ONCE** or **EVERY**.
- 3** Press CH- button.
- 4** Press VOL+ or VOL- button to set the **ON** time, for example **18:00**.
- 5** Press CH- button to select **POS** item.
- 6** Press VOL+ or VOL- button to select a channel number, for example, channel **10**.

OFF TIMER	EVERY
	22:00
ON TIMER	EVERY
	18:00
	POS 10
CLOCK	0:09:59
SELECT ↑↓	ADJUST ←→

The set in **STANDBY** mode auto turns on and goes to channel 10 when the time is 18:00. If you set the **ON TIMER** item to **ONCE**, this function effects only once; if you set the **ON TIMER** item to **EVERY**, this function effect every day. To cancel this function, set the **ON TIMER** to **OFF**.

! Notes:

The Time can not be accessed until you set the **ON TIMER** to **ONCE** or **EVERY**. When you are setting the time by VOL+/- button, if you press and release within 0.7 seconds, the time's increase or decrease step is 1 minute; if you press and hold for more than 0.7 second, the time increase or decrease step is 10 minute.

System Setting

To enter the Setting menu

- 1 Press MENU button.
- 2 Press VOL+ or VOL- buttons to select SETTING icon.
- 3 Press CH- button to display the SETTING menu.

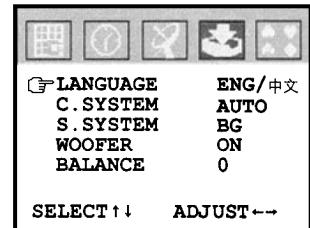

Selecting the OSD language

Please enter the **SETTING** menu first.

This TV set provides ENGLISH and CHINESE (中文) OSD language.

- 1 Press CH+ or CH- button to select LANGUAGE item.
- 2 Press VOL+ or VOL- button to select the OSD language.

Setting the colour and sound system

Please enter the **SETTING** menu first.

If the picture colour or sound is abnormal, maybe the colour and sound system setting is wrong. You can select a proper colour or sound system as follows;

- 1 Press CH+ or CH- button to select C.SYSTEM item.
- 2 Press VOL+ or VOL- button to select a proper colour system.
- 3 Press CH+ or CH- button to select S.SYSTEM item.
- 4 Press VOL+ or VOL- button to select a proper sound system.

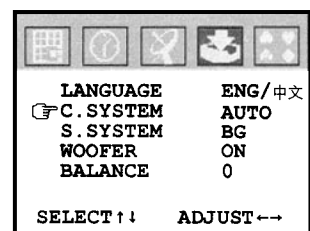

Notes:

You can quickly set colour and sound system by pressing the **SYS** button on the remote controller. Please select item by CH+/- button and adjust by VOL+/- button.

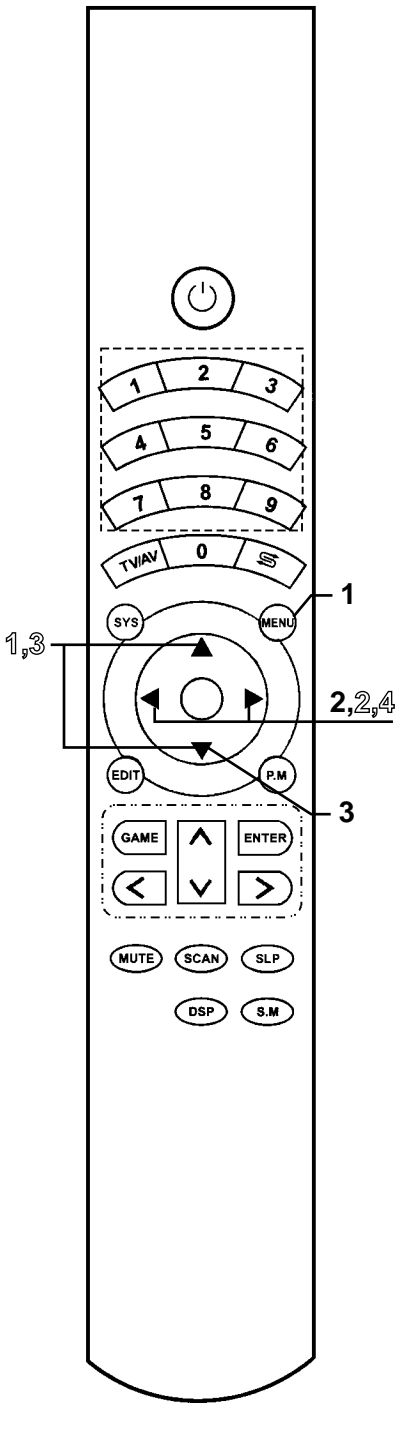
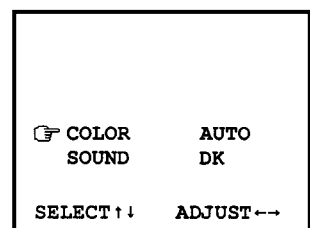

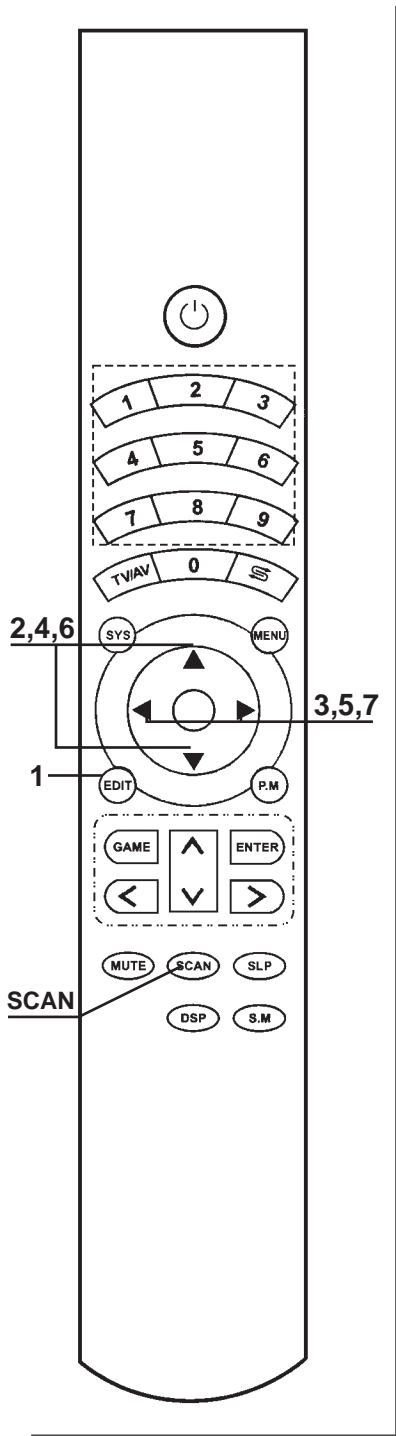

Channel Edit

This TV set enables you to edit the channel programs.

- 1** Press EDIT button on the remote controller.
- 2** Press CH+/- to select CHANNEL 1 item.
- 3** Press VOL+/- to select the first target channel.
- 4** Press CH+/- to select CHANNEL 2 item.
- 5** Press VOL+/- to select the second target channel.
- 6** Press CH+/- to select EXCHANGE item.
- 7** Press VOL+/- to exchange the two channel program.

To exchange more channels' programs, please repeat the above steps.

CHANNEL EXCHANGE	
CHANNEL1	9
CHANNEL2	8
EXCHANGE	↔
SELECT ↑↓	ADJUST ↔

Channel scanning

Press **SCAN** button on the remote controller and the TV set begins program scanning. All active channels will be scanned on by one. After scanning, the set stops at the original channel before the program scanning begins. Press any button can stop the process of scanning end the set stops at the current scanning channel.



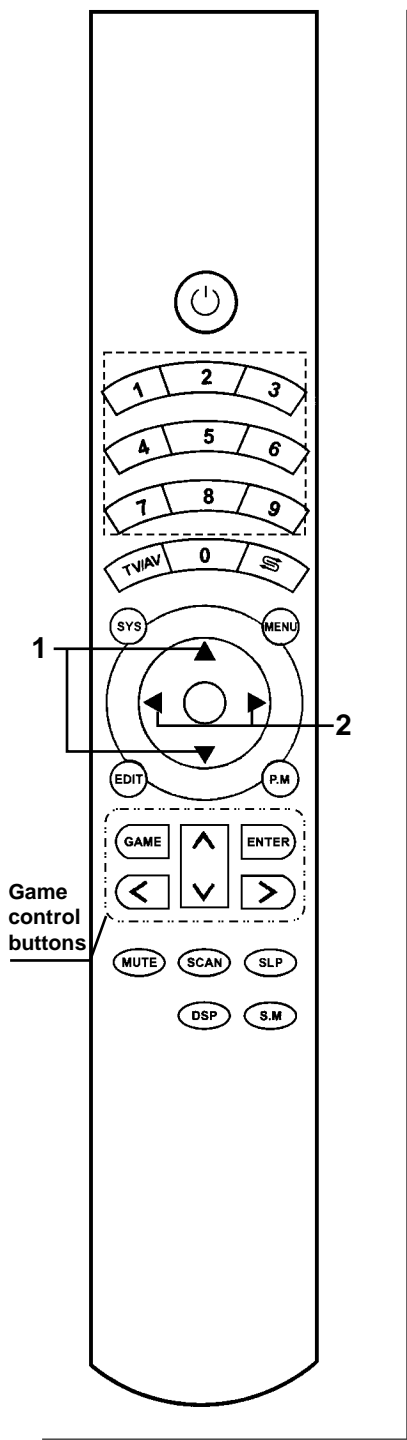

Playing BOX game

Please enter the **OTHER** menu first.

- 1 Press CH+ or CH- button to select BOX item.
- 2 Press VOL+ or VOL- buttons to enter.

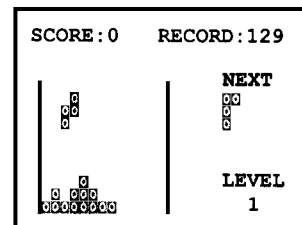

● Button Introduction

Button	Name	Function
	F1	To transform the shape.
	F2	To accelerate falling down.
	F3.	To move the boxes.

● How to play?

1. Press any one of F1, F2 or F3 buttons to start the game.
2. Press F1 to transform the shape; F2 to accelerate falling down; F3 to move the boxes.
3. When the boxes are placed fully in one row, this row will disappear and the score increases 1 point. The score increases 3 points if two rows of boxes disappear at the same time. Disappearing three rows at the same time makes 7 points.
4. The right window indicates the next shape for your reference.
5. The game is over when the boxes are piled to the top of the window.
6. Pressing the **GAME** button can exit the game.

Playing GOBANG game

Please enter the **OTHER** menu first.

- 1 Press CH+ or CH- button to select GOBANG item.
- 2 Press VOL+ or VOL- button to enter.



● Button Introduction

- : To move chessman
- : To confirm your move

● How to play?

In this game, you will play against the TV set. The part who firstly connects a continuous five chessmen in horizontal, vertical or diagonal direction wins the game.

Other Functions (continued)

Calendar setting

Please enter the **OTHER** menu first.

- 1 Press **CH+** or **CH-** button to select **CALENDAR** item.
- 2 Press **VOL+** or **VOL-** buttons to enter **CALENDAR**.

Pressing **▲** or **▼** button can select year, month or date; Pressing **◀** or **▶** button can adjust year, month or date.

Press any button except **▲**, **▼**, **◀** or **▶** to exit calendar.

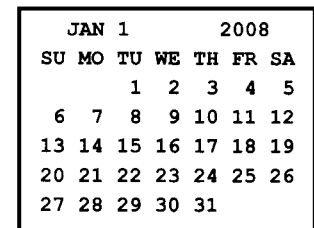

Remote controller caller

This TV set provides RC (remote controller) calling function, which will help you to find the RC if you do not know where the RC is. You just need to press the **CALL** button on the set's side panel (the set should be in **STANDBY** or working), the RC will play a musical tone so that you can quickly get it. When the set auto turns on through **ON TIMER** function, the RC also plays a musical tone to remind you. To active the above functions, please turn the Calling Switch to **ON** firstly (the Calling Switch is on the top of the RC's left side).

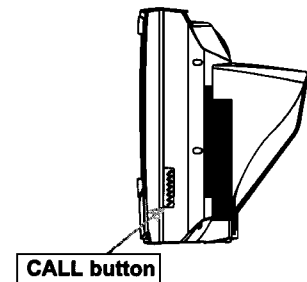

! Notes:

1. The RC will play a musical tone when you turn the Calling Switch to **ON**. If you want to stop the music, please turn the Calling Switch to **OFF** and then turn it **ON** quickly.
2. The RC consumes more power if the calling function is turned on, so we recommend you to use high-capacity batteries. If you do not use the RC for a long period of time, please turn off the calling function to avoid power exhaustion.
3. If the Calling function is turned on and the RC is close to mobile phone or other radiant equipment, the RC may be triggered and play the musical tone. To stop the music, please follow step 1.
4. It is normal that some slight stripes appear on the screen when you press **CALL** button on the set.
5. The top and middle position of the Calling Switch is **ON** and the bottom position is **OFF**.

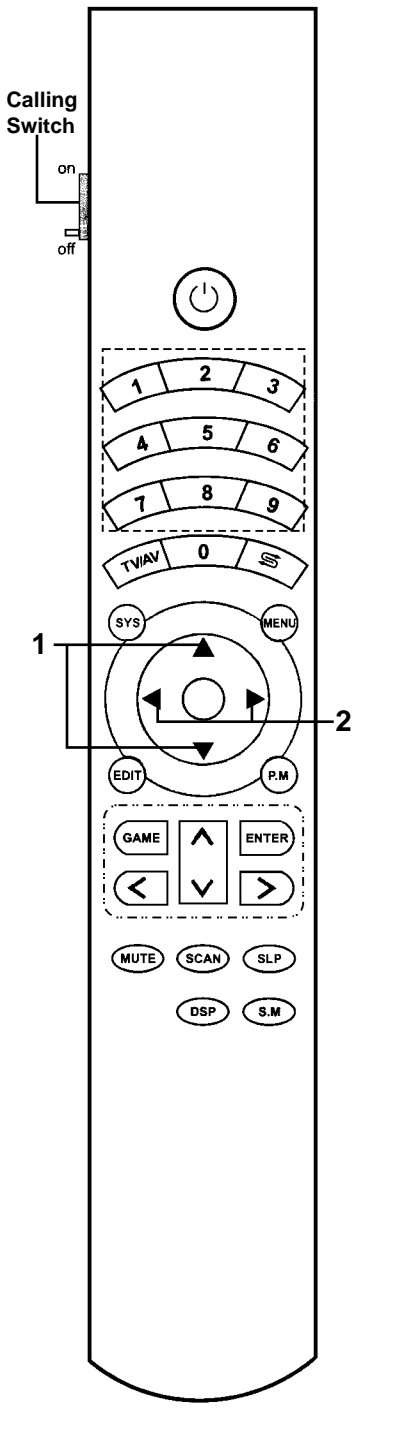

Other Functions

To enter the OTHER menu

- 1 Press MENU button.
- 2 Press VOL+ or VOL- buttons to select OTHER icon.
- 3 Press CH- button to display the OTHER menu.



Notes:

You can quickly access the OTHER menu by pressing GAME button on the remote controller.

Playing HITTING game

Please enter the OTHER menu first.

- 1 Press CH+ or CH- button to select HITTING item.
- 2 Press VOL+ or VOL- button to enter.

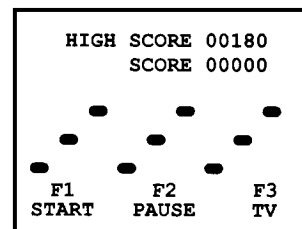

Button Introduction

Button	Name	Function
	F1	To start the game.
	F2	To pause the game.
	F3.	To exit the game.

How to play?

Press F1 button to start the game. The 1-9 digit buttons on the remote controller match the 9 target boxes on the screen. Pressing any one of these buttons can hit the relevant box, The score will be counted according to the amount of the box hit within the stipulated time.

Playing SLOT game

Please enter the OTHER menu first.

- 1 Press CH+ or CH- button to select SLOT item.
- 2 Press VOL+ or VOL- button to enter.

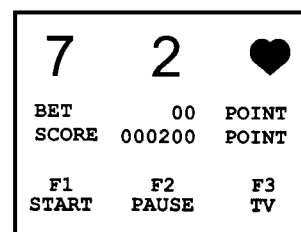

Button Introduction

Button	Name	Function
	F1	To start the game.
	F2	To pause the game or set rate.
	F3.	To exit the game.

How to play?

Before you start the game, you can set the rate by using F2. Press F1 button to start the game. Press F2 to control the card (or set the rate). If you turn over 3 cards with the same value then you win the game, or you will lose the game. If you want to exit the game, please press F2 to pause the game firstly before you press F3.

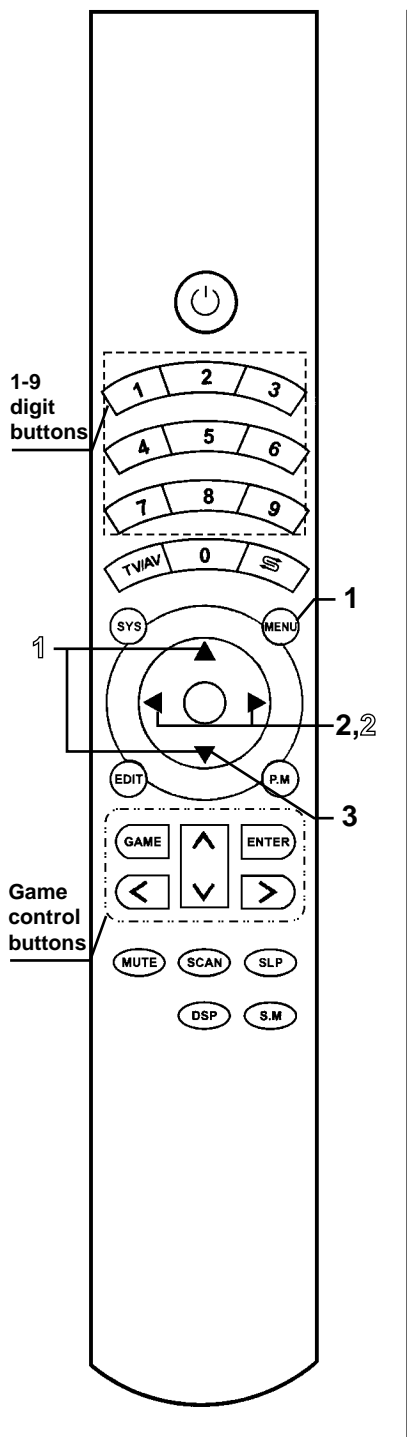

Troubleshooting Guide

Before calling service personnel, please check the following chart for a possible cause to the trouble you are experiencing.

Symptoms	Check the following items
Power is not turned on	<ul style="list-style-type: none"> □ Be sure the power cord is plugged in.
Poor colour, poor tint	<ul style="list-style-type: none"> □ Contrast, colour, tint are not correctly adjusted
Spots appear on the screen	<ul style="list-style-type: none"> □ Possible interferences of automobiles, motorcycle, trolley bus, neon lamps, etc.
Stripes appear on the screen	<ul style="list-style-type: none"> □ Possible interference of electronic interference from another TV set, a computer, an electronics game machine, a broadcast station, etc.
Double images or "ghosts"	<ul style="list-style-type: none"> □ This may be caused by reflections from nearby mountains or buildings. □ Check the antenna direction.
Snowy picture	<ul style="list-style-type: none"> □ It is possible that the aerial "lead-in" is damaged or comes off. □ Check the antenna direction.
No Program menu page and the maximum volume is only 60.	<ul style="list-style-type: none"> □ Check whether the HOTEL mode is in LOCK status.
TV cabinet creaks	<ul style="list-style-type: none"> □ Even if the picture or the sound is normal, changes in room temperature sometimes makes the TV cabinet expand or contract, making a noise. This does not indicate a malfunction.
Remote controller does not work	<ul style="list-style-type: none"> □ The batteries may be worn out. □ The batteries may be installed with their polarity reversed.
Unevenness in colour in some parts of the screen	<ul style="list-style-type: none"> □ When the set is switched on, do not shift or move the set around. Sometimes it may develop an unevenness in colour in some parts of the screen. This can be eliminated by switching off the set with the POWER switch and wait for 10 minutes before switching on again.
Remote controller plays music continually or makes "Beep" sound	<ul style="list-style-type: none"> □ The batteries power is insufficient, please replace with high-capacity batteries.

Specifications

Power Supply: AC 240V, 50Hz
Power Consumption: 140W
Dimensions(mm): 670(W) x 688(H) x 510(D)
Weight(kg): 43
CRT: 68cm

TV system & channel range

System	VHF	UHF	CATV
PAL-B/G	2-12	21-69	X~Z+2,S1~S41

Color System: PAL-B/G NTSC playback
Sound output: 6W x 2
Accessories: Remote controller X 1

ⓘ Design and specifications are subject to change without notice.

PALSONIC CORPORATION PTY LTD
1 JOYNTON AVENUE
WATERLOO NSW 2017 AUSTRALIA
TEL:(02)9313 7111
FAX:(02)9313 7555
www.palsonic.com.au

**PALSONIC CUSTOMER SERVICE
TELEPHONE
AUSTRALIA: 1300 657 888**

604-K29183-01

Free Manuals Download Website

<http://myh66.com>

<http://usermanuals.us>

<http://www.somanuals.com>

<http://www.4manuals.cc>

<http://www.manual-lib.com>

<http://www.404manual.com>

<http://www.luxmanual.com>

<http://aubethermostatmanual.com>

Golf course search by state

<http://golfingnear.com>

Email search by domain

<http://emailbydomain.com>

Auto manuals search

<http://auto.somanuals.com>

TV manuals search

<http://tv.somanuals.com>