

OWNER'S MANUAL

Palsonic

**68CM CORDLESS REMOTE COLOUR TELEVISION
MODEL: 6845PFST**



Type Tested
Electrical
Safety

AS/NZS 3250 Lic 4166
Standards Australia
APP No: N15900

PALSONIC CORPORATION PTY LTD
1 JOYNTON AVENUE
WATERLOO NSW 2017 AUSTRALIA
TEL: (02) 9313 7111
FAX: (02) 9313 7555
www.palsonic.com.au

**PALSONIC CUSTOMER SERVICE
TELEPHONE
AUSTRALIA: 1300 657 888**

Contents

Congratulations on your purchase of this Palsonic colour television.

We recommend that you thoroughly read this manual before use to fully enjoy the many functions and excellent effects of this equipment.

Retain this manual in an easily accessible location for future reference.

* Screen displays and illustrations in this manual may differ from the actual ones for better visibility.

Contents

Features	1	Channel Selection	17
Safety precautions	2	Picture adjustment	18
Identification of Controls	4	to select the picture mode	18
Front	4	Picture adjustment	18
Back	4	Sound Controls	19
Remote Controller	5	Adjusting volume	19
Antenna Connection	6	Sound mode selection	19
Installation	7	To select stereo/bilingual mode	20
External equipment		To enter into earphone state	20
connections	8	Timer Setting	21
Using the side Audio/Video jacks	8	Setting clock	21
to connect the 21-Pin scarts.....	9	Setting OFF time	21
To connect the AV outputs.....	9	Setting ON timer	22
Power on/off	10	Setting Timer set	22
Turning on	10	Special functions	23
Turning off	10	To select OSD language	23
Selecting Input Signal	11	Setting blue back	23
Watching AV program	11	Rotate function	23
Switching from AV to TV	11	Screen aspect selection	23
Tuning in	12	Child lock setting	24
Automatic tuning	12	Hotel Lock Setting	25
Manual Tuning	13	Game playing	25
Fine tuning	14	Teletext	27
Setting colour system	15	Troubleshooting Guide	28
Setting sound system	15	Specifications	30
Channel delete	16		
To order the channels	16		

Main features

- **Hyperband**
- **Automatic channel preset**
- **Full function remote control**
- **21-pin scarts and AV input/output (RCA) jacks**
- **Selectable picture and selectable sound**
- **NICAM and German stereo/bilingual broadcasts (optional)**
- **Teletext**
- **ON Timer, OFF Timer**
- **Real Clock (with teletext signal)**
- **Channel swap**
- **Child lock (option)**
- **Hotel lock (option)**
- **Digital comb-filter**
- **SMV (scan velocity modulation) (option)**
- **Black stretch, CTI (Colour Transient Improver) function**
- **Game**
- **AVL (automatic volume level) (option)**
- **Bass/Treble/Balance control**
- **MSS (Micronas surround sound) (option)**
- **DBE (Dynamic Bass Enhanced) (option)**
- **Picture rotate (option)**

Safety precautions

Note: This TV set can operate on an AC power of 240V, 50Hz. You must not use a power supply of any other type.

- ◆ When any unusual situation occurs, turn off the power supply at once and remove the plug from the wall outlet. Contact a qualified service department in your local area.

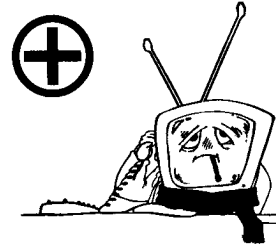

- ◆ Do not expose the TV set to rain or excessive moisture. Avoid using the set in very warm or damp places and never use it in a bathroom.

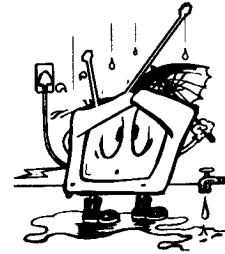

- ◆ When cleaning dust off the picture tube disconnect the power first. You can wipe lightly with a piece of dry, clean and soft cloth.

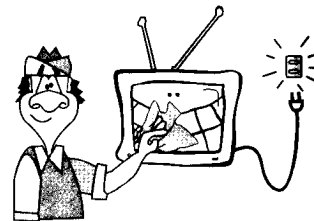

- ◆ Avoid exposing the set to direct sunlight and other sources of heat to prevent damage to the cabinet and components.

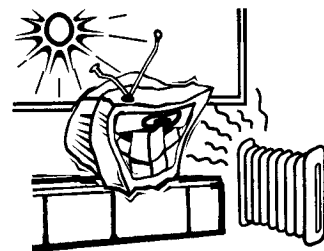

- ◆ High voltage exists in this TV set. Do not remove the cover

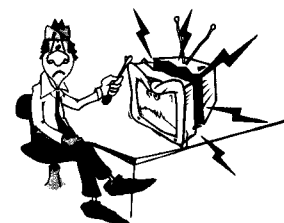

Safety precautions

- ◆ Do not cover the ventilating hole in the cabinet. Keep a space of more than 10cm from the walls to the TV set to ensure adequate ventilation.

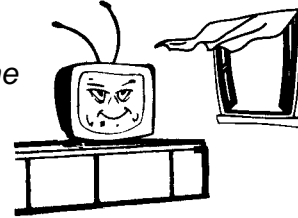

- ◆ If the power cord or the plug is damaged contact a qualified service department for service.

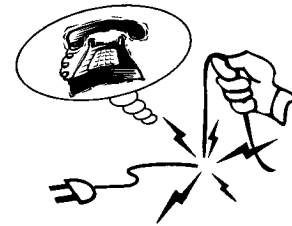

- ◆ When the TV set is to be left unattended for a long period of time, turn off the power supply and remove the plug from the wall outlet.

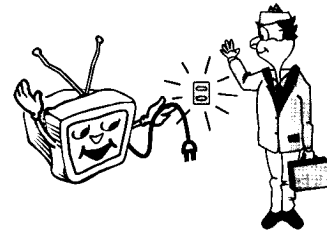

- ◆ Don't try to push anything into the cabinet or place any vessel with water on the TV set.

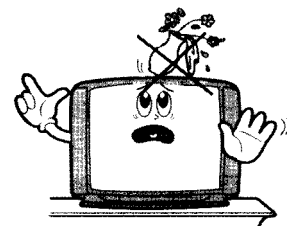

- ◆ Don't overload wall outlets; extension cords, or integral convenience receptacles as this can result in a risk of fire or electric shock.

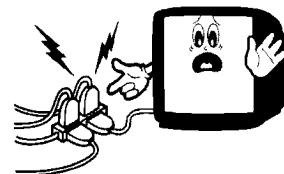

Identification of Controls

Front

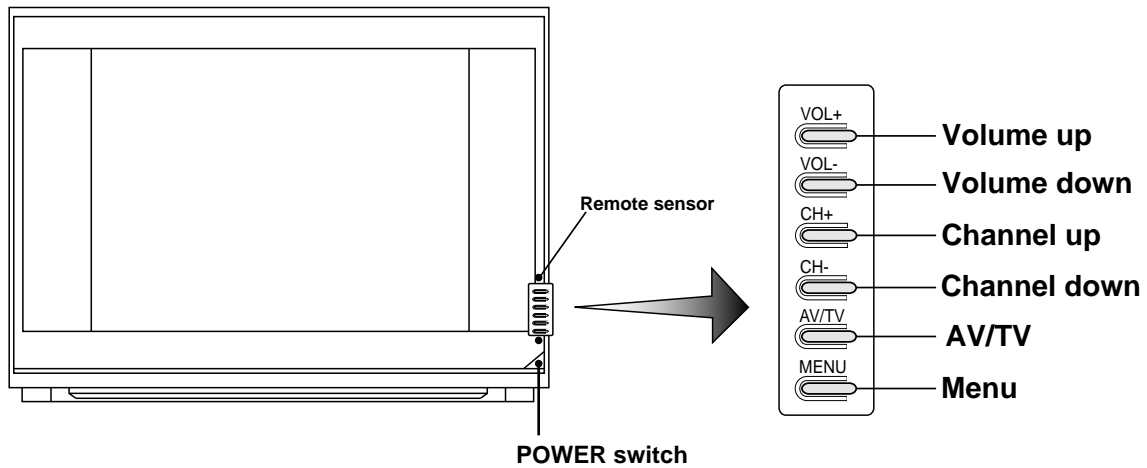

Back

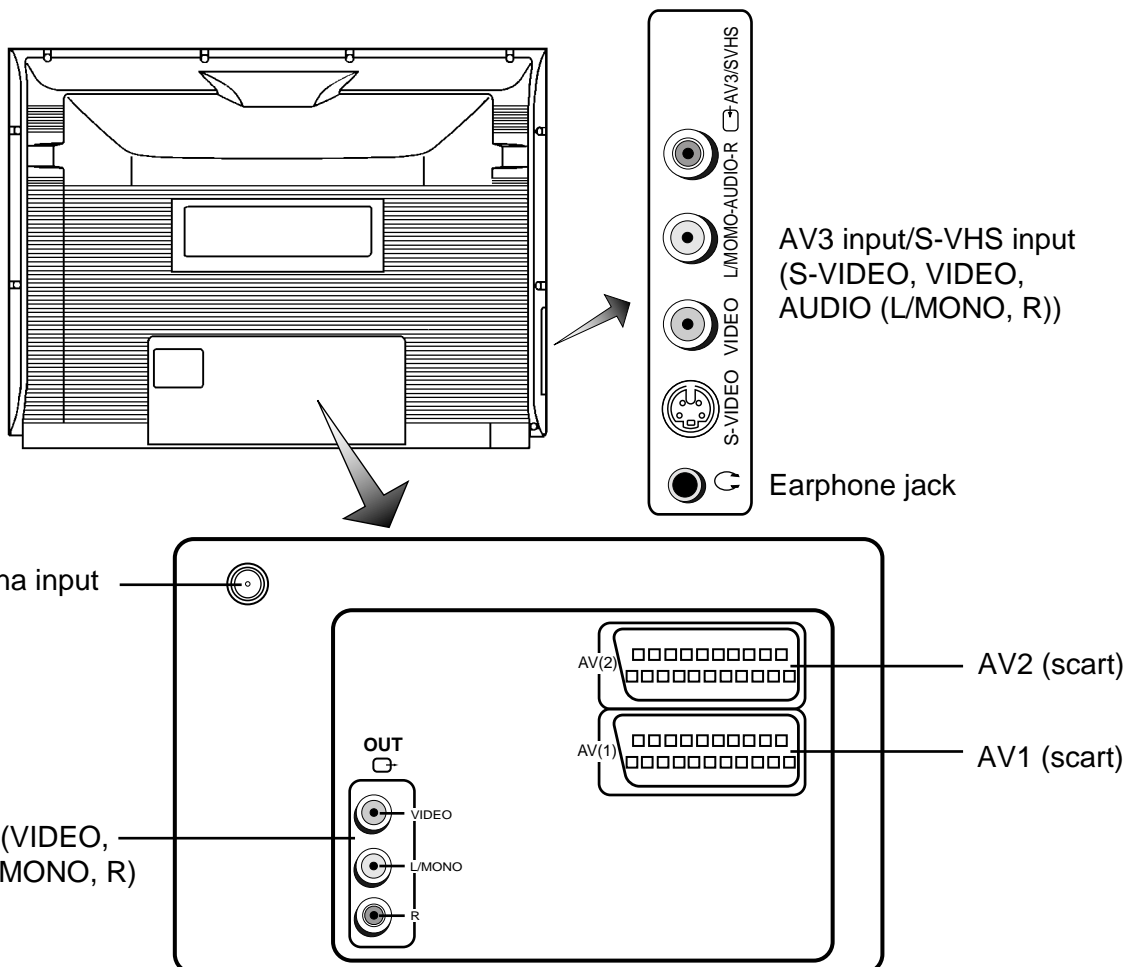

Identification of Controls

Remote controller

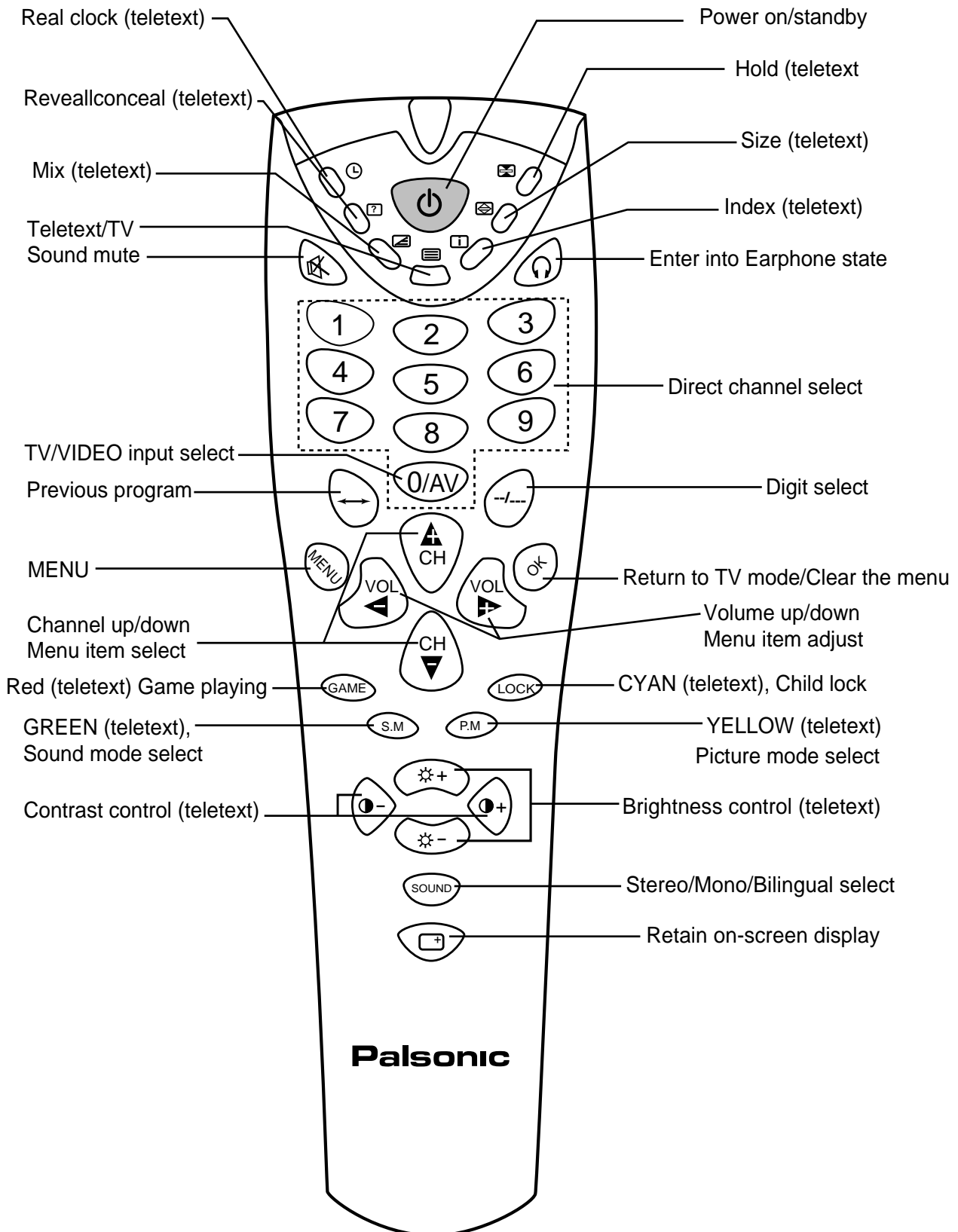

Antenna connection

Optimum reception of colour requires a good signal and will generally mean that an outdoor aerial must be used. The exact type and position of the aerial will depend upon your particular area.

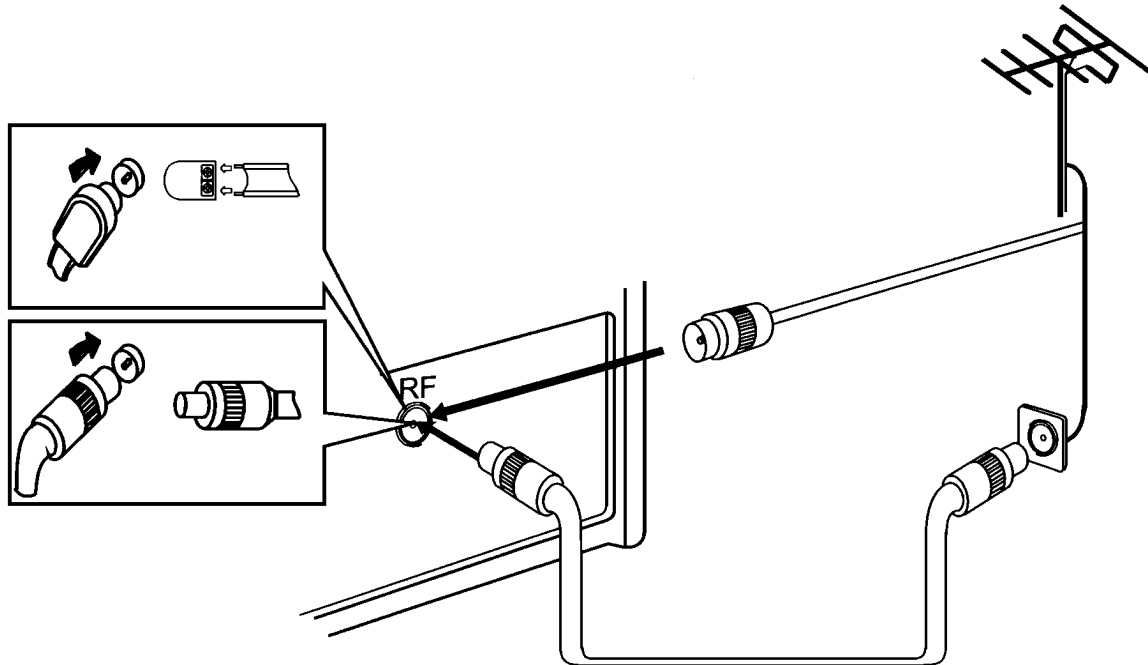

⚠ Notes:

- It is recommended that the 75-ohm coaxial cable be used to eliminate interference and noise which may occur due to radio wave conditions.
- The aerial cable should not be bundled with the power cord and the like.

INSTALL the unit in a room where direct light will not fall upon the screen. Total darkness or a reflection on the picture screen may cause eyestrain. Soft and indirect lighting is recommended for comfortable viewing.

Installation

Installing batteries

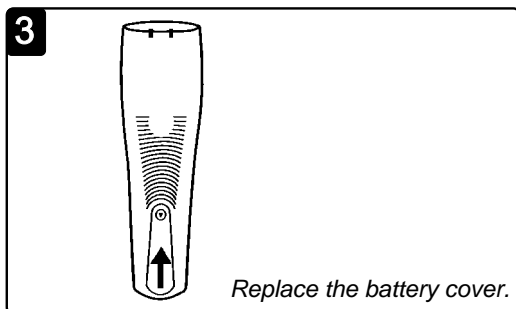
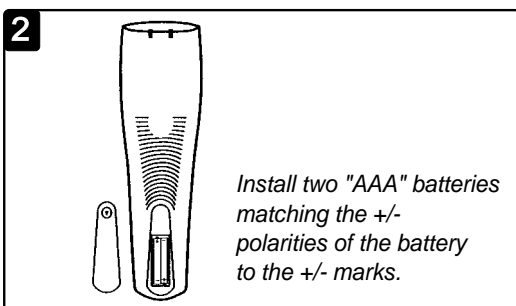
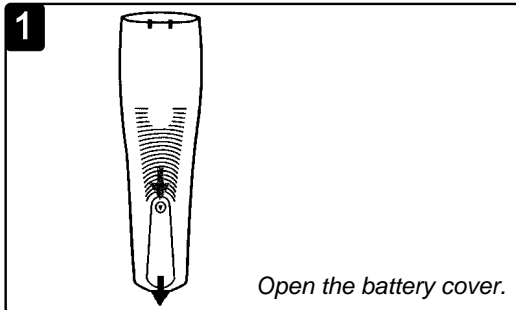

! Notes:

- Do not try to recharge batteries they are not intended to be recharged.
- Use only the size and type of batteries specified. Do not mix different types of batteries together or old batteries with fresh ones.
- When the remote control will not be used for a long period of time or when the batteries are worn out, remove the batteries.
- Do not throw the batteries into a fire. Dispose of used batteries in the specified manner.
- Do not drop, dampen or disassemble the remote control.

Effective range of the Remote

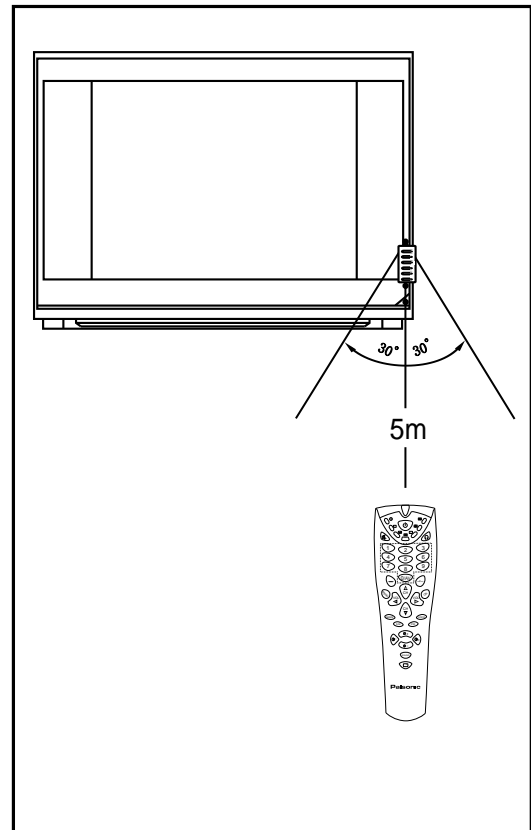

! Notes:

- When there is an obstacle between the TV and the transmitter, the transmitter may not operate.
- When direct sunlight, and incandescent lamp, fluorescent lamp or any other strong light shines on the REMOTE SENSOR of the TV the remote operation may be unstable.

External equipment connections

Using the side AUDIO/VIDEO Jacks

The optimal use for the side A/V jacks are to connect an A/V component that is used only occasionally, such as a camcorder or video game. Connect the Audio/Video output jacks of the external unit to the Audio Input jacks and the Video Input jacks.

The figure below shows how to connect the AV3 input jacks to video equipment.

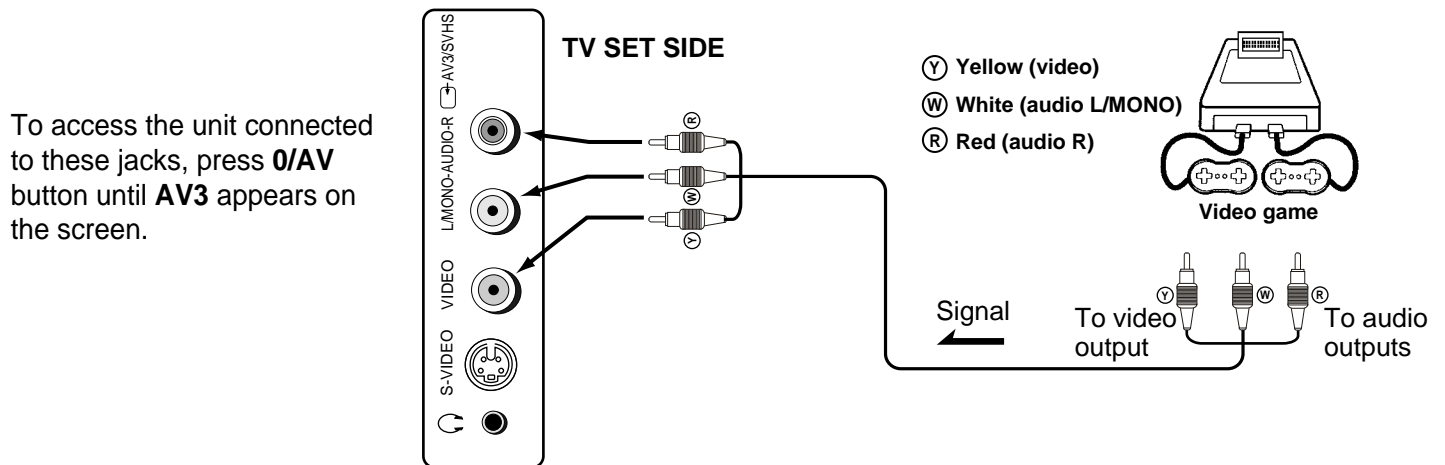

The figure below shows how to connect the SVHS input to video equipment.

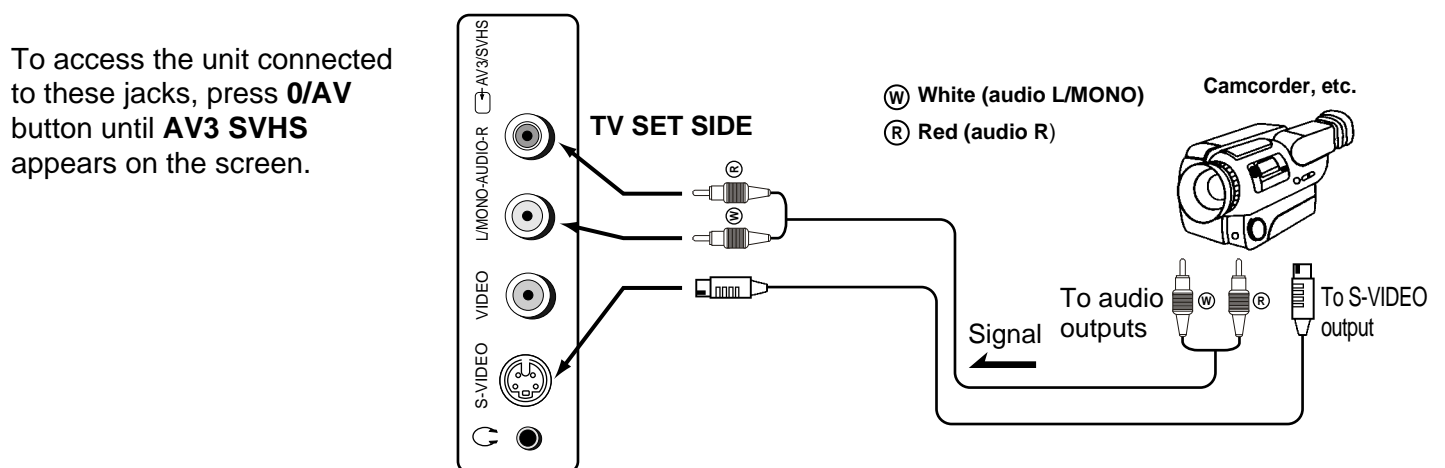

Note: The S-VIDEO input terminal has priority over AV3 VIDEO terminal. To use equipment connected to AV3 VIDEO terminal, disconnect any plug from the S-VIDEO terminal.

External equipment connections

To connect the 21-Pin Scarts

This TV set is equipped with 21-Pin Scarts for your desired equipment to be connected.

The figure below shows how to connect the AV1 SCART to video equipment.

To access the unit connected to AV1 SCART, press the **0/AV** button until **AV1** appears on the screen.

If the signal source is RGB signal, the OSD will be **AV1 RGB**.

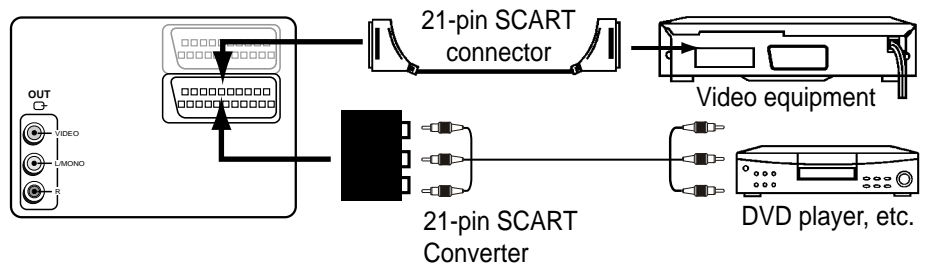

Note: If the equipment you want to connect is not equipped with 21-pin Scart, you can connect it by using the **21-pin Scart Converter** (supplied) as illustrated above.

The figure below shows how to connect the AV2 SCART to video equipment.

AV2 SCART, press the **0/AV** button until **AV2** appears on the screen.

If the signal source is RGB signal, the OSD will be **AV2 RGB**.

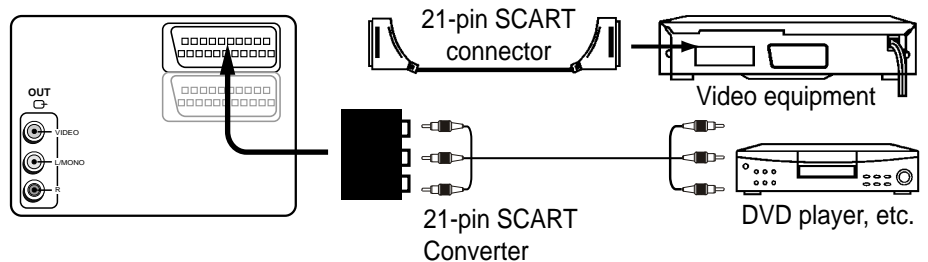

Note: If the equipment you want to connect is not equipped with 21-pin Scart, you can connect it by using the 21-pin Scart Converter (supplied) as illustrated above.

To connect the AV Outputs

You can connect a stereo system to the AV output jacks on the TV set rear to enjoy a high-quality sound from the stereo system, or you can connect the AV output jacks to the VTR to record the program you like.

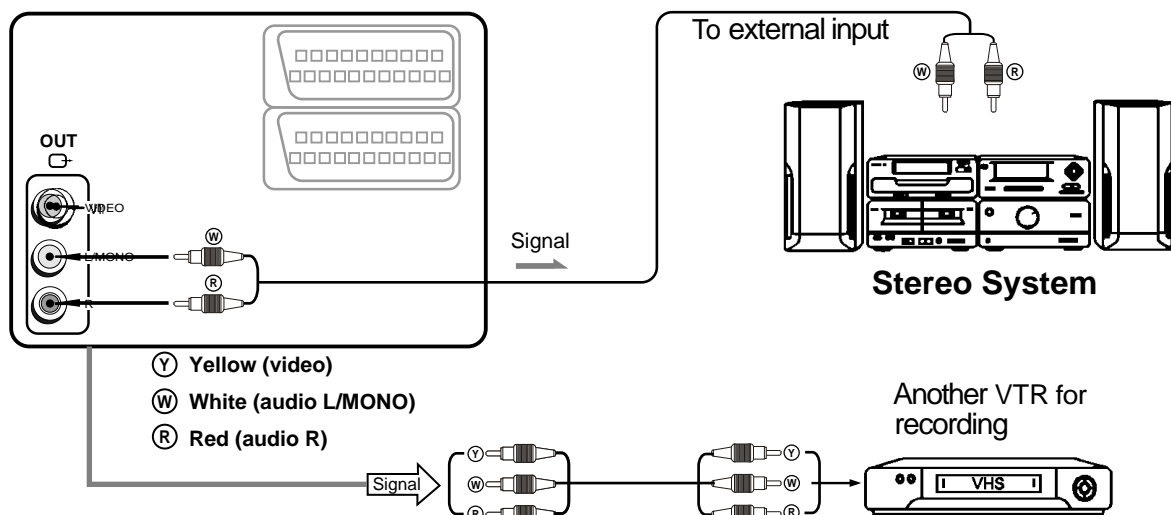

Power on/off

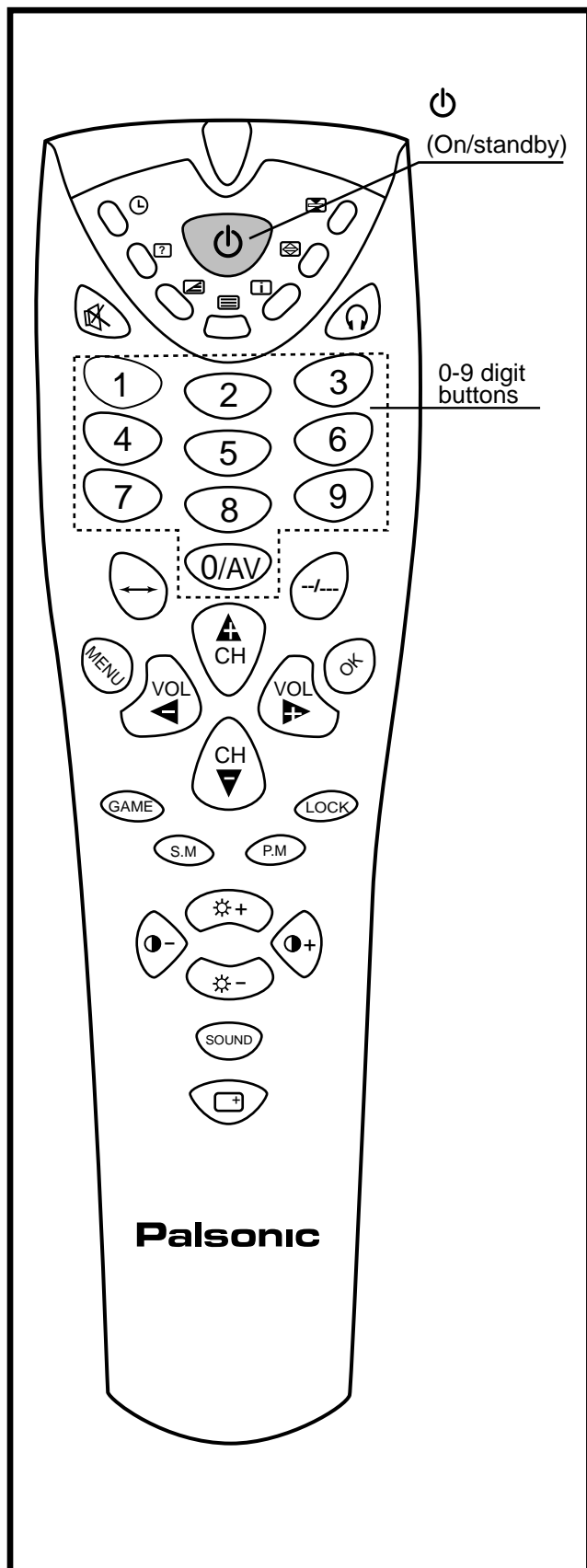

Turning on

1 Press the Power Switch on the TV set.

Now the standby indicator lights up, the TV set is in STANDBY mode. Now please follow step 2.

2 In STANDBY mode, press the $\text{\textcircled{P}}$ button or 0-9 digit button on the remote controller and the TV set is turned on.

In STANDBY mode, you can also press Channel up/down or AV/TV button on the set to turn on the set.

Turning off

1 Press the Power Switch on the TV set if you want to cut off the power completely.

2 If you want to turn off the TV set temporarily, press the $\text{\textcircled{P}}$ button.

Channel delete & to order the channels

Watching AV program

This TV set provides AV input terminals and 21 -pin scarts for your convenient connection to VCR, DVD or other video equipments.

- 1 To watch video program from AV inputs or 21-pin scarts, Press 0/AV button repeatedly until you see the appropriate input indicator on the screen.

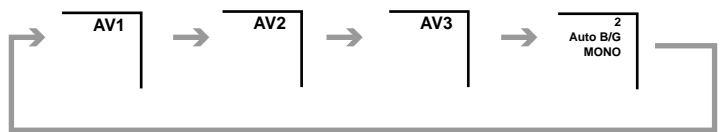

Notes:

When the signal source input through AV1/AV2 is RGB signal, the OSD is AV1 RGB/AV2 RGB.

When AV3 S-VIDEO is used, the OSD is AV3 S-VHS.

Switching from AV to TV

When the TV set is in AV mode, there are three ways for you to switch back to TV mode as follows.

- 1 Press 0/AV button repeatedly until the TV program appears.
- 2 Press the OK button to switch back to TV mode.
- 3 Press CH+/- button to switch back to TV mode.

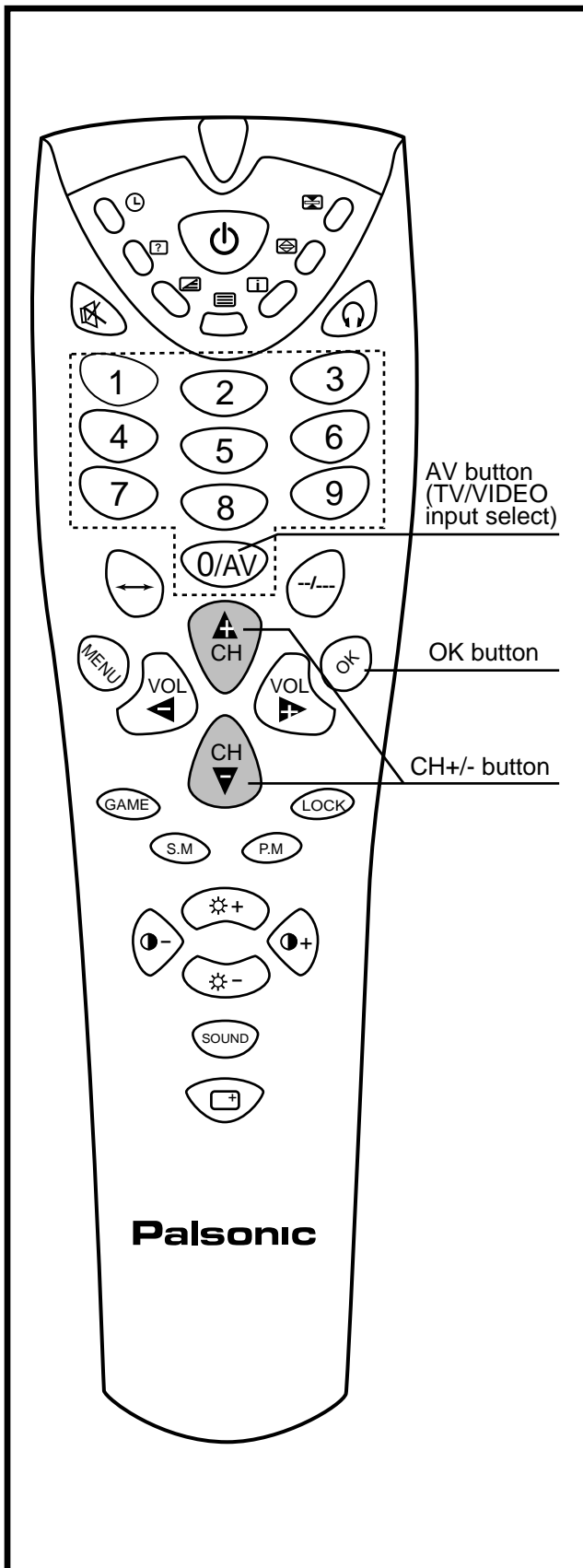

Tuning in

Automatic Tuning

- 1 Press **MENU** repeatedly to display **Tuning** menu.

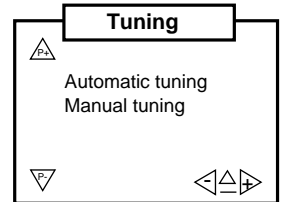

- 2 Press **CH+** or **CH-** to select **Automatic tuning**.

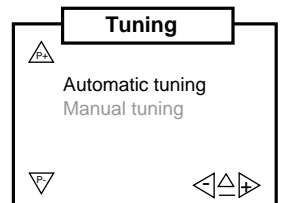

- 3 Press **VOL+** to start automatic tuning. All active channels will be preset and stored into memory automatically.

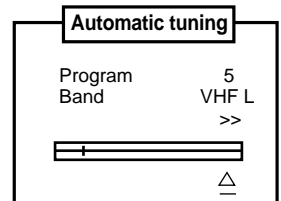

After automatic tuning, the set will return to the first channel program.

During automatic tuning, pressing **OK** button will stop the process.

Note:

Before Automatic tuning, we recommend you to set a proper Sound System according to your local area. (see page 15)

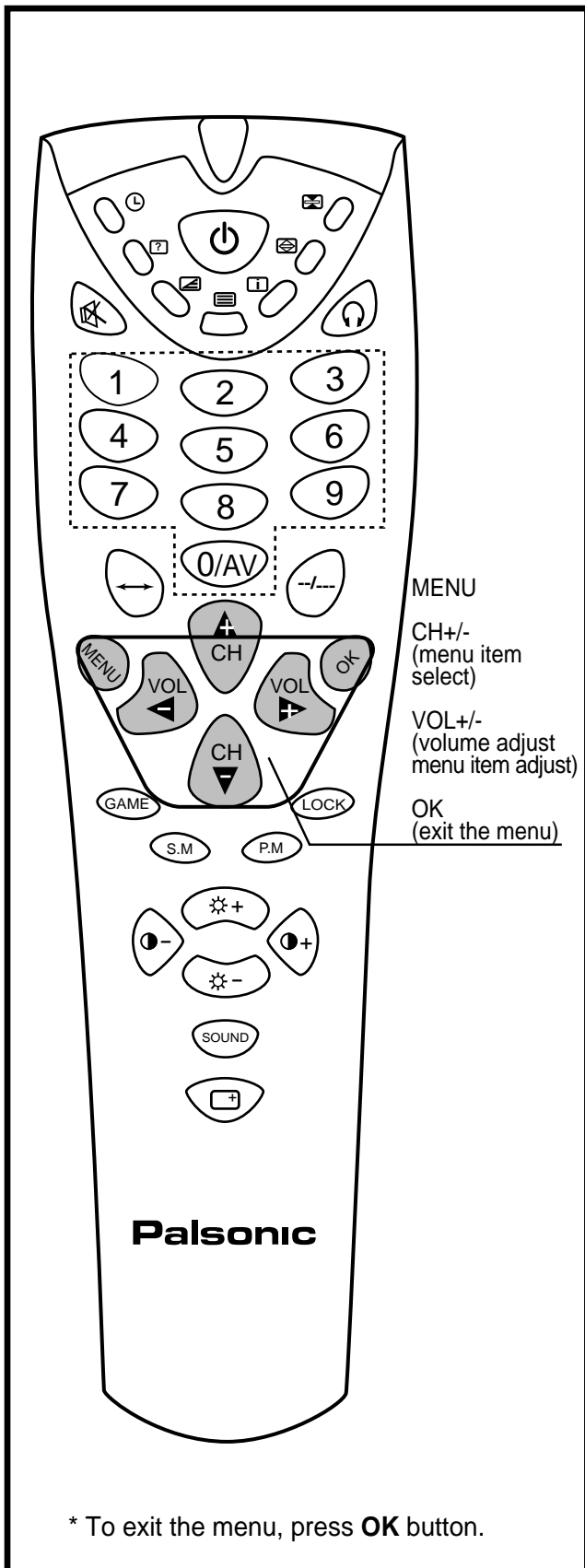

* To exit the menu, press **OK** button.

Tuning in

Manual tuning

If automatic tuning can not preset the desired channels, or you want to preset the desired channels one by one with the preferred channel numbers, please make use of Manual tuning.

- 1 Repeatedly press **MENU** to enter into **Tuning** menu.
- 2 Press **CH+** or **CH-** to select **Manual tuning**.
- 3 Press **VOL+/-** to enter into Manual tuning submenu.
- 4 In **Manual tuning** submenu, press **CH+/-** to select **Program**, use **VOL+/-** to select a number, or you can directly input the number by digit buttons.
- 5 Press **CH+/-** to select **Manual search**, press **VOL+/-** to start searching. The **VOL-** searches towards lower frequency; the **VOL+** towards higher frequency. When a channel is located, the searching stops and the channel is stored in the specified position number.

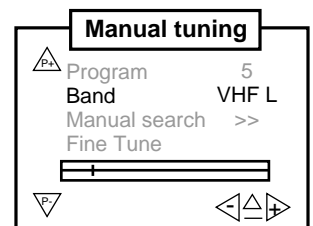
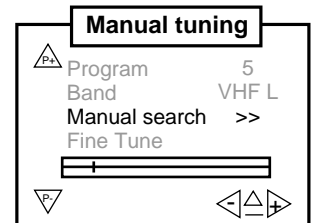
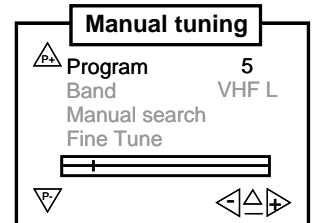
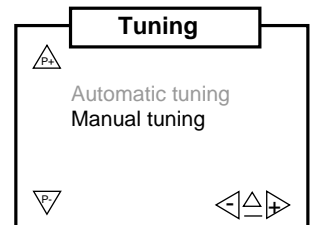

Notes:

1. In manual tuning, you can also use **BAND** selection to quicken searching process if you know which band your desired program locates in. The band switches among VHF L, VHF H and UHF.
2. Repeat the above 1-5 steps if you want to store another program in other position number.

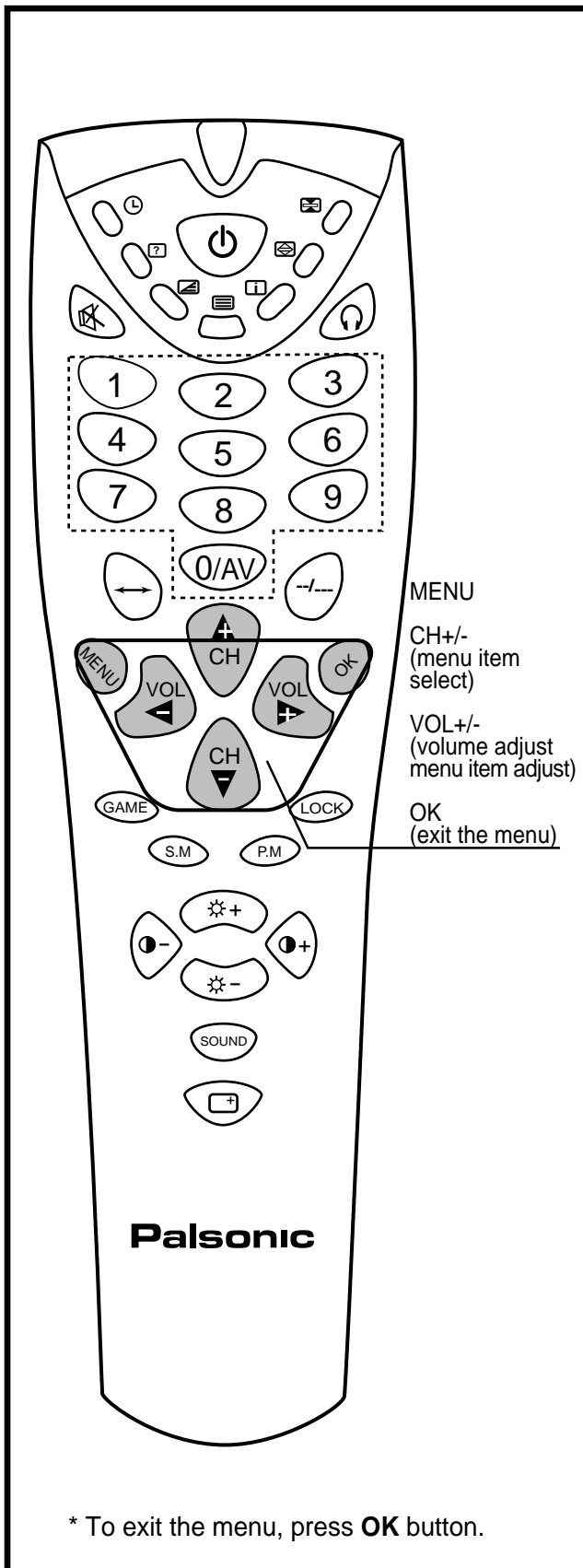

* To exit the menu, press **OK** button.

Tuning in

Fine tuning

Fine tuning is not necessary under normal conditions. However, in area of inferior broadcast conditions where adjustment is necessary for a better picture and sound, use Fine tuning.

- 1 Select a channel you want to fine-tune (for example: channel 28).
- 2 Press **MENU** repeatedly to display **Tuning** menu.
- 3 Press **CH+/-** to select **Manual tuning**, press **VOL+/-** to enter into Manual tuning sub-menu.
- 4 Press **CH+/-** to select **Fine tune**.
- 5 Press **VOL+/-** to begin fine tuning until the best possible picture and sound are obtained.

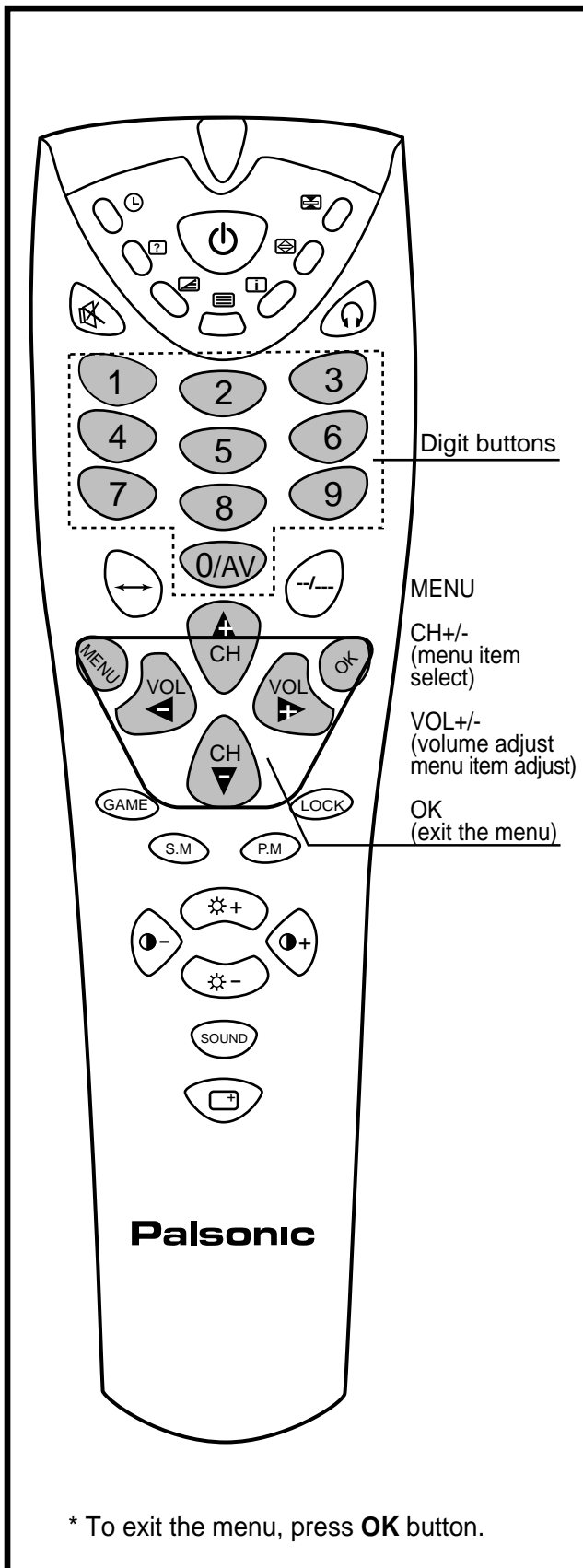
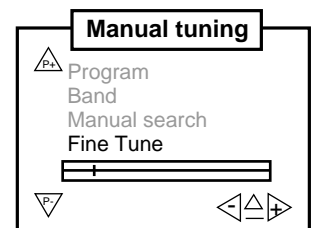
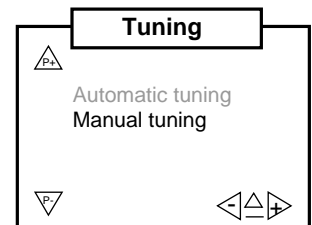
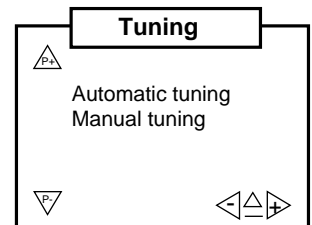

Tuning in

Setting Colour System

If some channel's colour is abnormal, it may be that the setting of the colour system is wrong, please do the following steps to set a proper colour system.

- 1 Press **MENU** repeatedly to display **Special functions** menu.
- 2 Press **CH+/-** to select **Color system**.
- 3 Press **VOL+/-** to select a proper colour system.

Special functions	
Language	English
Blue back	On
Rotate	50
Aspect	4:3
Child lock	Off
Color system	Auto
Sound system	B/G

Setting Sound System

If some channel's sound is abnormal, it may be that the setting of the sound system is wrong, please do the following steps to set a proper sound system.

- 1 Enter into **Special functions** menu.
- 2 Press **CH+/-** to select **Sound system**.
- 3 Press **VOL+/-** to select a proper sound system.

Special functions	
Language	English
Blue back	On
Rotate	50
Aspect	4:3
Child lock	Off
Color system	Auto
Sound system	B/G

Some models are only with one sound system and in this case the Sound System does not need to be adjusted.

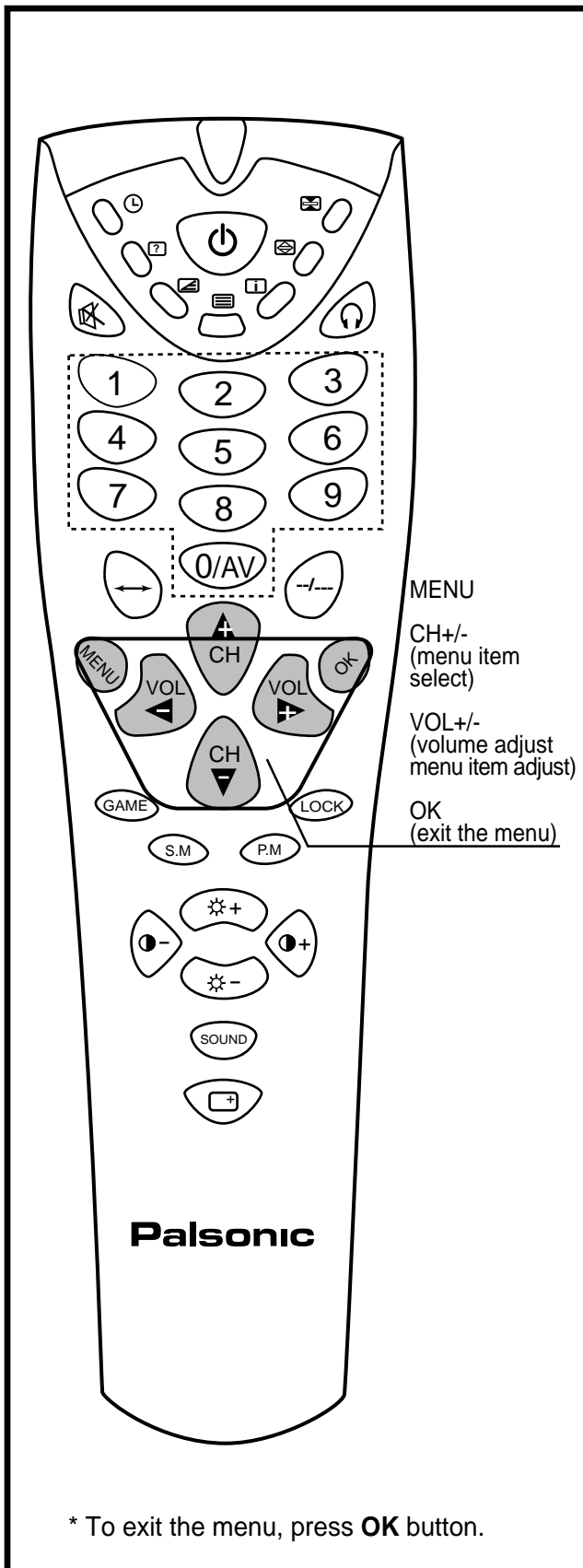

Channel delete & to order the channels

To delete an unnecessary channel

After presetting the channels, you may delete unnecessary channels so that only the channels you want to watch are selected.

- 1 Use digit buttons or channel up/down button to select a channel you want to delete (for example: channel 18).
- 2 Press **MENU** repeatedly to display **Program sort** menu.
- 3 Press **CH+/-** to select **Delete Prg**.
- 4 Press the **S.M** button to confirm.

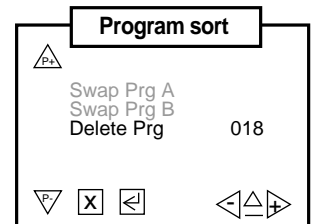

Please wait for some time until the "Delete Prg" menu item does not glitter (for the system needs time to delete program)

Now channel 18's program is deleted, and channel 19's program move to channel 18, and so on.

To order the channels

You can edit the channel programs in your favourite order.

- 1 Press **MENU** repeatedly until **Program sort** menu appears.
- 2 Press **CH+/-** to select **Swap Prg A**, use **VOL+/-** to select a program number, or you can directly press digit buttons to input the number, for example, 23.
- 3 Press **CH+/-** to select **Swap Prg B**, use **VOL+/-** to select a program number, or directly press digit buttons to input the number, for example: 37. (If wrong in inputting, you can press **RED** button to cancel and input again.)
- 4 Press **S.M** button to confirm. Now program 23 and program 37 are swapped.

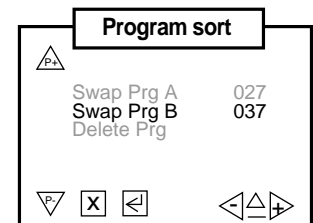
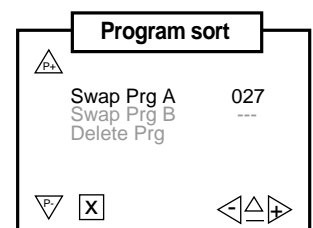

Repeat the above steps to edit the programs in your favourite order.

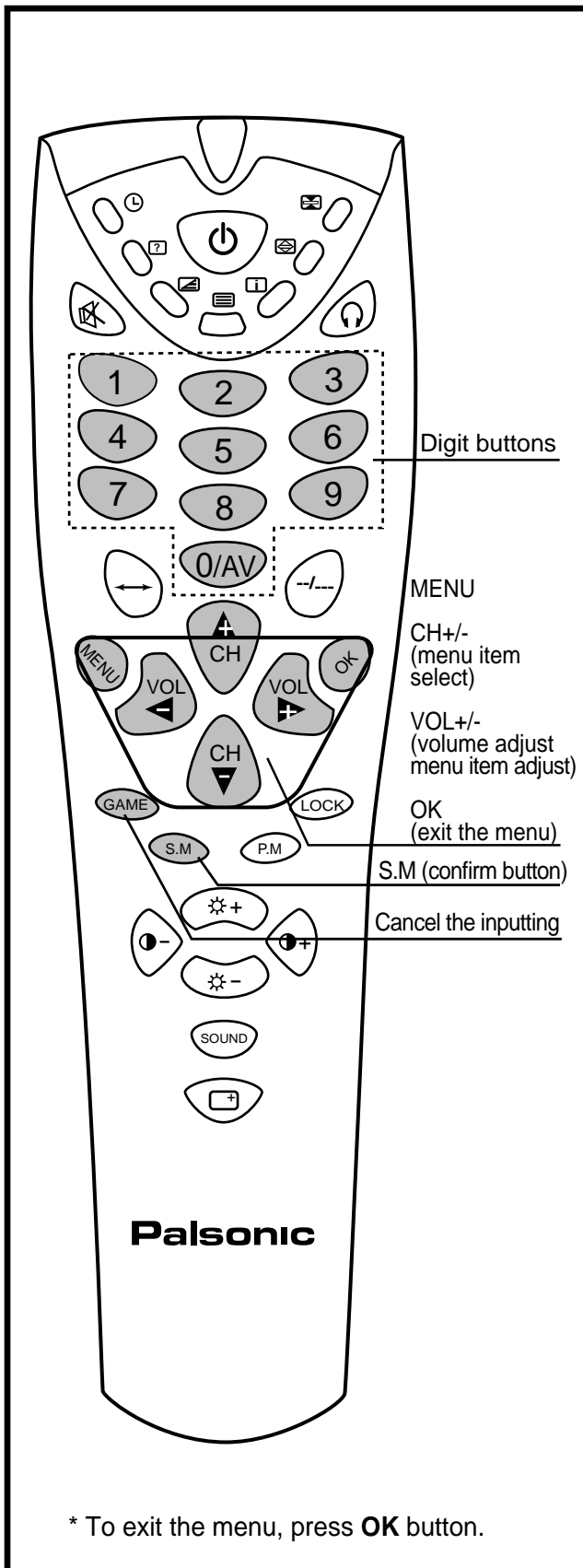

* To exit the menu, press **OK** button.

Channel selection

1 Use Direct Channel Select buttons

To select one-digit channel:

Press --/-- button to display "--", then input the number.

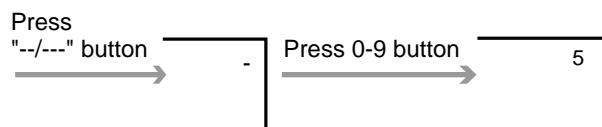

To select two-digit channel:

Press --/-- button to display "--", then input the number.



To select three-digit channel:

Press --/-- button to display "--", then input the number.



* In this model the maximum channel number is 255.

2 Use CH+ or CH- button

Press **CH+** button, the channel number increases;
Press **CH-** button, the channel number decreases.

3 Use previous program button (↔)

Press this button to switch between the current program and the previous one.

Notes:

Use on-screen display button () to know the current channel number

Press this button to display the current TV state. If in TV program viewing, then it will display the current channel number, colour system, sound system and sound mode. Press it again to cancel the display.

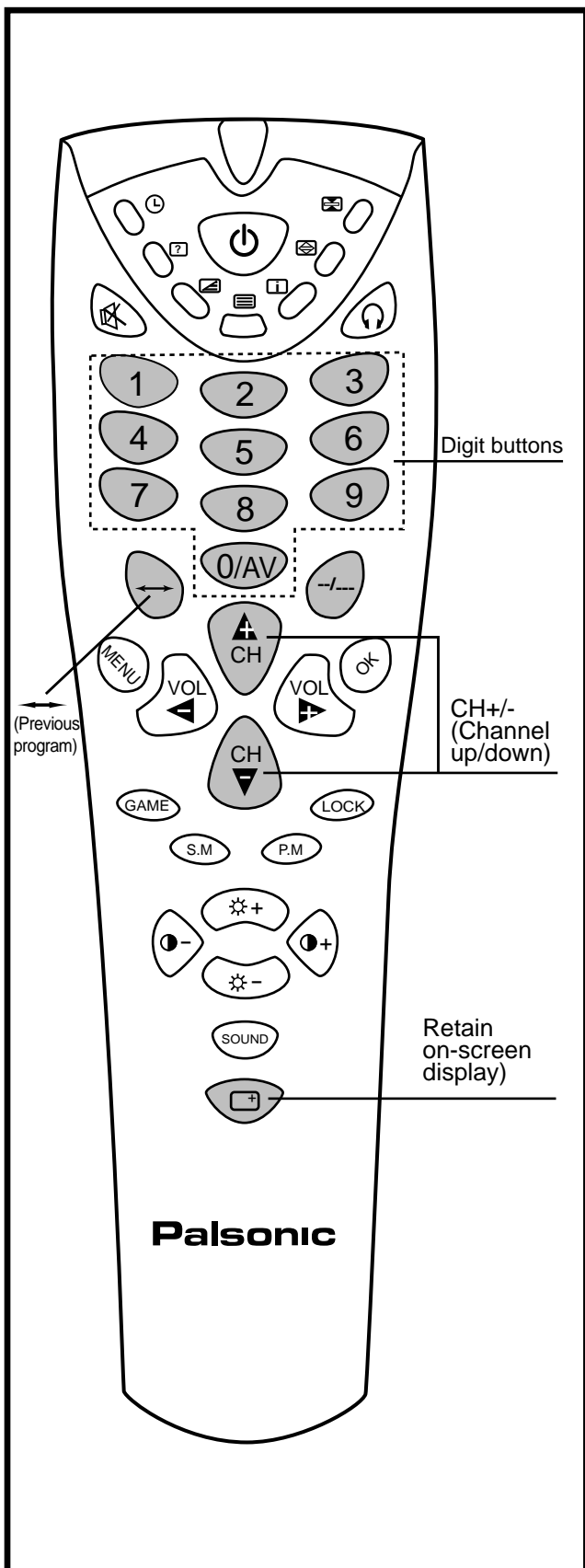
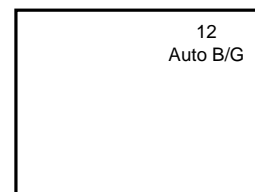

Picture adjustment

To select the picture mode

You can select the picture quality instantly among three preset modes and one user-set mode.

Press the **P.M** button to select the desired picture quality. **Standard**, **Dynamic**, **Mild** and **Favourite** (user-set) can be selected cyclically.

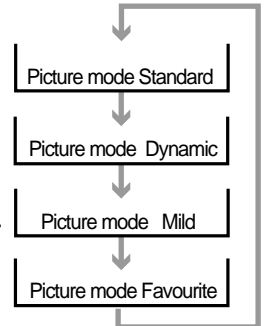

Mode	Picture quality
Standard	Display normal pictures
Dynamic	Display more brightness and contrast pictures
Mild	Display mild pictures
Favourite	The picture quality you set

Picture adjustment

- 1 Press **MENU** to display Picture menu.
- 2 Press **CH+** or **CH-** to select desired adjusting item.
- 3 Press **VOL+/-** to adjust.

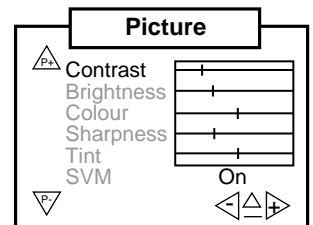

Item	VOL-	VOL+
Contrast	weaker	stronger
Brightness	darker	lighter
Colour	paler	deeper
Sharpness	softer	sharper
Tint*	purplish	greenish
SVM	High/Mid/Low/Off	

Notes:

Tint is only for NTSC system.

Turning on **SVM** will greatly improve picture's sharpness.

* SVM is an optional function.

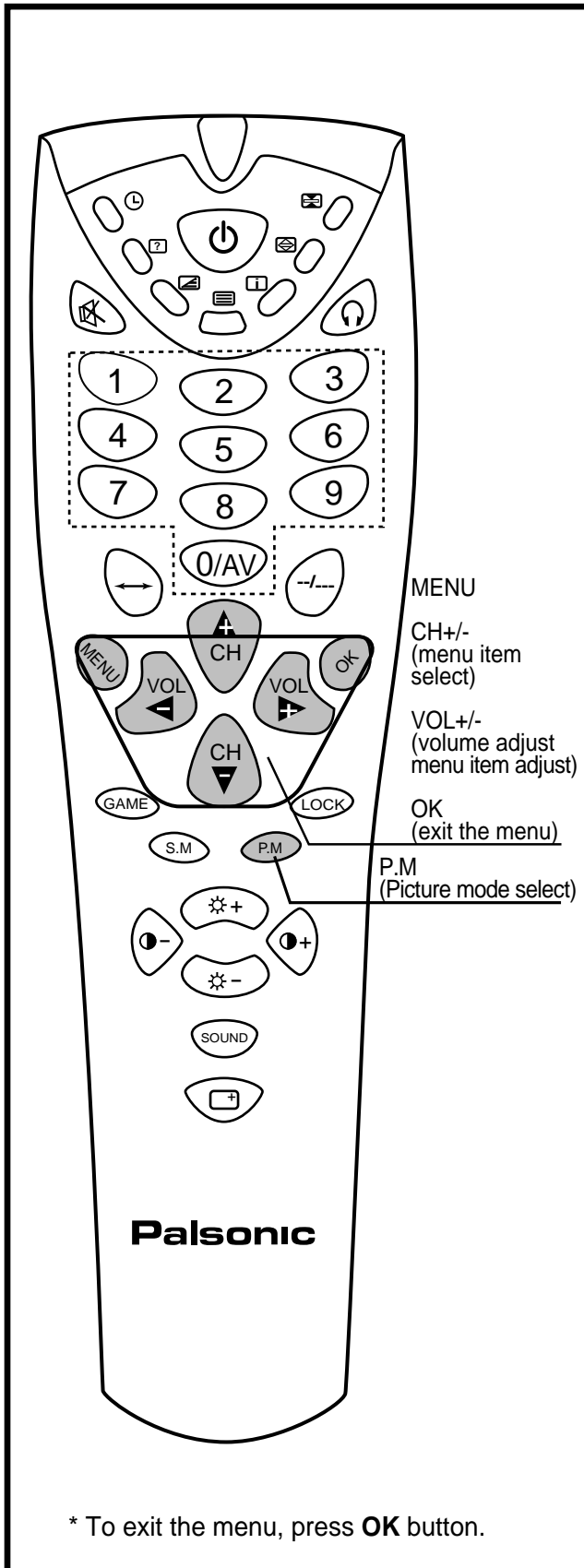

Sound controls

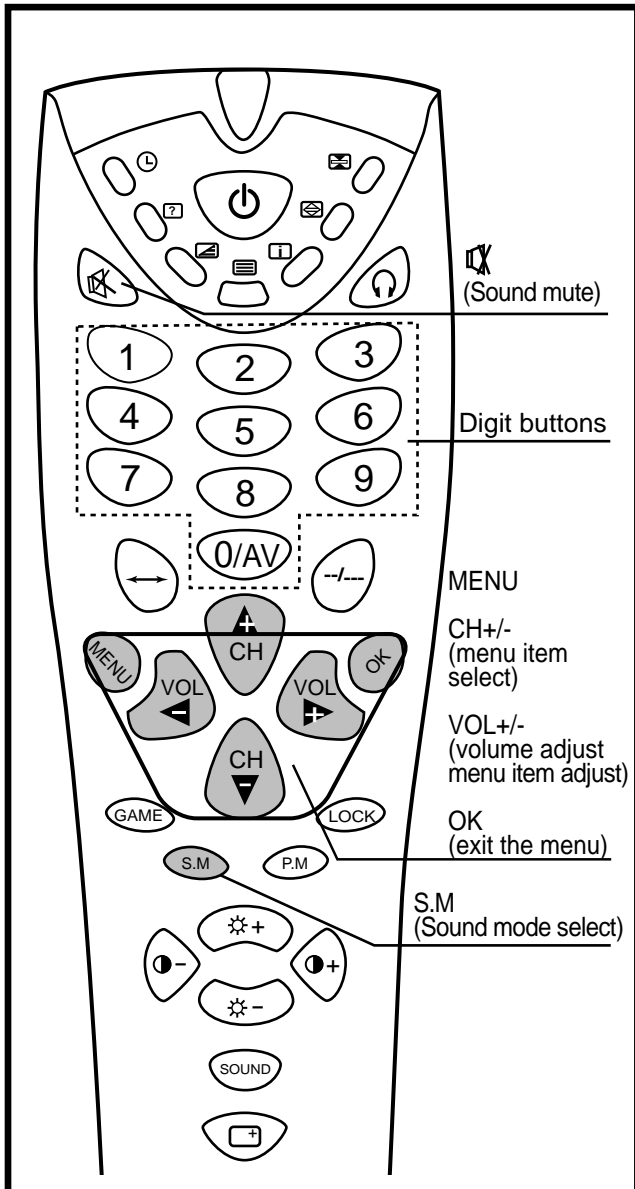

Adjusting volume

1 Use VOL+ or VOL- button.

Press **VOL+** button, the volume increases;
Press **VOL-** button, the volume decreases.



2 Use MUTE button.

If you want to mute the sound, press  button on the remote.

To resume the sound, press this button again.



Adjusting sound

1 Press MENU repeatedly to display Sound menu.

2 Press CH+ or CH- to select desired adjusting item.

3 Press VOL+/- to adjust the level.

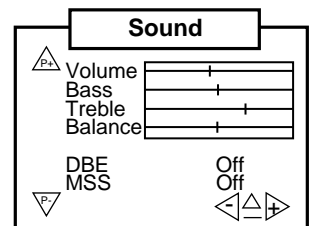

Item	VOL-	VOL+
Volume	weaker	stronger
Bass	weaker	stronger
Treble	weaker	stronger
Balance	decrease the right channel	decrease the left channel
DBE (Dynamic bass enhanced)	ON/OFF	
MSS (Micronas surround sound)	ON/OFF	

The adjusted level is stored in the Favourite position.

Note: DBE/MSS function are optional function.

Sound mode selection

You can select the sound quality instantly among three preset modes and one user-set mode.

Press the **S.M** button to select the desired sound quality. **Movie**, **Music**, **Speech** and **Favourite** (user-set) can be selected cyclically.

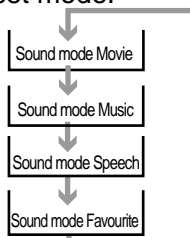

Mode	Sound quality
Movie	like a movie theatre filled with a dynamic sound
Music	like a music hall filled with a rich warm sound.
Speech	Suitable for listening to news/dialogue
Favourite	the sound quality you set

Sound Controls

The unit receives both stereo and bilingual broadcasts transmitted in either the NICAM or German stereo/bilingual broadcast system.

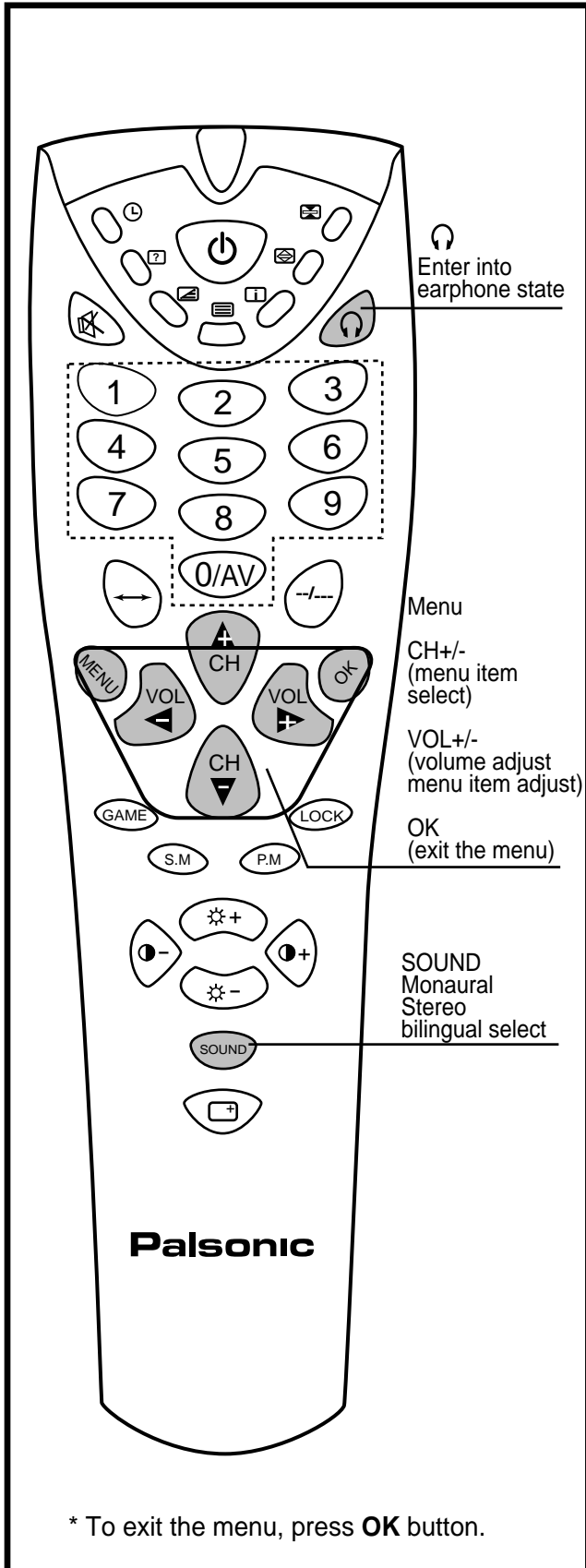

* To exit the menu, press **OK** button.

Stereo Programs

- 1 When a stereo program is received, **STEREO** appears.

12
Auto B/G
Mono

- 2 Press the **SOUND** button to select the stereo/monaural mode.

12
Auto B/G
Mono

Bilingual Programs

- 1 When a bilingual program is received, **DUAL** appears.

22
Auto B/G
Dual I

- 2 Press **SOUND** button to select the sound to be heard, **Dual I** and **Dual II** appear cyclically on the screen. As for NICAM-dual program, **Mono** and **Dual I** and **Dual II** appear cyclically on the screen.

Notes:

As for FM Germany Dual program, press **SOUND** button, the sound mode will switch between Dual I and Dual II.

To enter into earphone state

Press button to enter into earphone state, in this state, sound is outputted through earphones and speakers' sound is muted. Press the button again to restore.

In earphone state, the sound menu is shown on the right figure:

In the menu, use **CH+/-** to select item, **VOL+/-** to adjust the level. Or you can directly press **VOL+/-** button to adjust earphone volume.

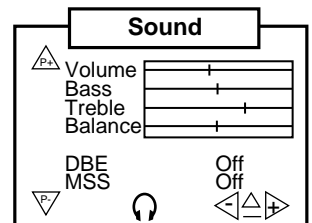

Timer setting

Setting clock

1 Press **MENU** button repeatedly to display **Timer** menu.

2 Press **CH+/-** to select Clock.

3 Use digit buttons to input the current time for the set. If wrong in setting the time, press **RED** button to cancel and input again.

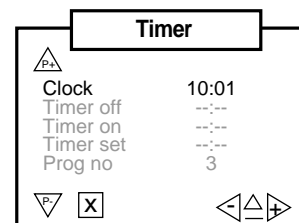

Notes:

Before setting the timer, please first set the **CLOCK** item. Press the main power switch to turn off the set, the clock will be cancelled. You need to reset it if you want to use the timer function.

To turn off TV automatically (OFF timer)

With the OFF timer, the TV will automatically switch to standby mode at a preset time.

1 In **Timer** menu, press **CH-** to select **Timer off**.

2 Use Digit Buttons to set the OFF time. In wrong in inputting, press **RED** button to cancel and input again.

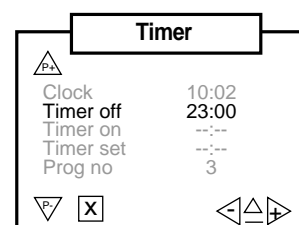

At the preset time, the TV will go into standby mode automatically.

Once the OFF timer has been fulfilled, next when you want to use it, you should reset it again.

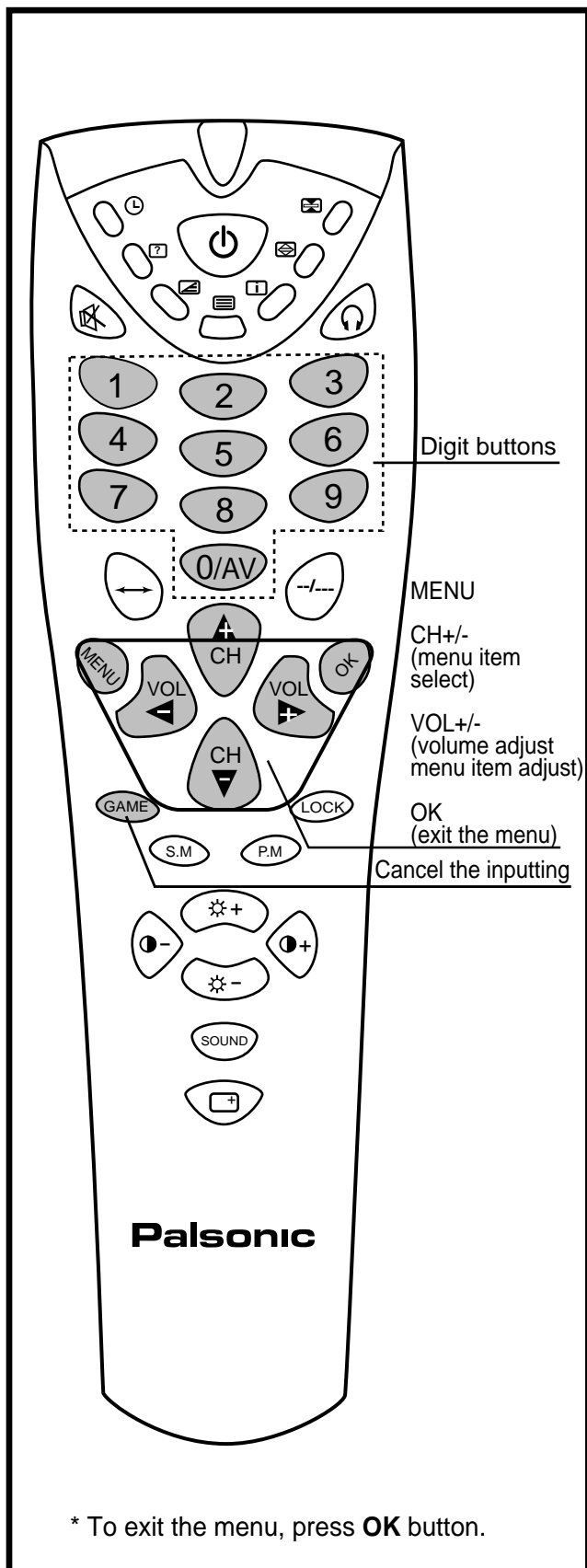

Timer setting

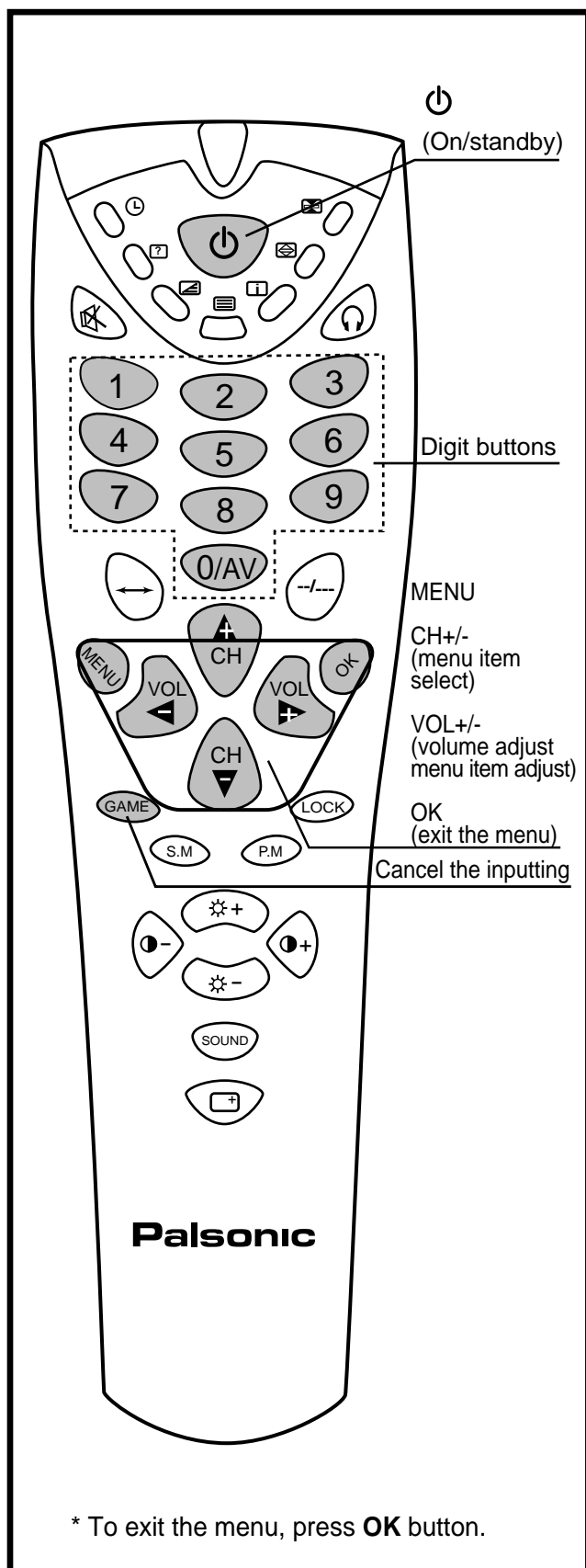

To turn on the TV automatically (ON timer)

With the ON timer, the TV will automatically turn on to a preset channel at a preset time.

- 1 In **Timer** menu, press **CH-** to select **Timer on**.
- 2 Use Digit Buttons to set ON time. If wrong in inputting, press **RED** button to cancel and input again.
- 3 Press **CH-** to select **Prg no.**, use **VOL+/-** to set the ON program, or you can directly input the number by digit buttons.
- 4 Press **STANDBY** (⏻) button to switch the TV to standby mode.
At the preset time, the TV will turn on to the preset program automatically.

Timer	
Clock	10:02
Timer off	12:00
Timer on	14:05
Timer set	--:--
Prog no	5

Once the ON timer has been fulfilled, next when you want to use it again, you should reset it.

To switch the TV to a program at a preset time

- 1 In **Timer** menu, press **CH+/-** to select **Timer set**.
- 2 Use Digit buttons to set the time. If wrong in inputting, press **RED** button to cancel and input again.
- 3 Press **CH-** to select **Prg no.**, use **VOL+/-** to set a program number, or directly input the number by digit buttons.
At the preset time, the TV will automatically switch to the preset program.

Timer	
Clock	10:05
Timer off	23:00
Timer on	--:--
Timer set	18:00
Prog no	2

Timer	
Clock	10:06
Timer off	23:00
Timer on	--:--
Timer set	18:00
Prog no	14

Note:

When you turn off the TV by main power switch, all functions in Timer menu will be cancelled.

Special functions

To select OSD language

There are multi OSD languages in this TV set provided for you to select (OSD: on-screen display):

- 1 Press **MENU** repeatedly to display **Special functions** menu.

Special functions	
Language	English
Blue back	On
Rotate	50
Aspect	4:3
Child lock	Off
Color system	Auto
Sound system	B/G

- 2 Now the first menu item is highlighted and indicates the current selected OSD language. (if in English it will display ENGLISH).

- 3 Press **VOL+/-** to select a proper OSD language.

Setting blue back

- 1 Enter into **Special functions** menu

Special functions	
Language	English
Blue back	On
Rotate	50
Aspect	4:3
Child lock	Off
Color system	Auto
Sound system	B/G

- 2 Press **CH+/-** to select **Blue back**.

- 3 Press **VOL+/-** to turn on/off blue back.

If the Blue back is turned on, the TV will appear a blue back on the screen when there is no input signal.

Rotate function

When you switch on your TV there may be a slight tilt of the picture to the left or right. This is due to the earth's magnetic field or position of your TV. To rectify, you can do the following:

- 1 Enter into **Special functions** menu.

Special functions	
Language	English
Blue back	On
Rotate	30
Aspect	4:3
Child lock	Off
Color system	Auto
Sound system	B/G

- 2 Press **CH+/-** to select Rotate.

- 3 Press **VOL+/-** to rotate the picture until you are satisfied.

Screen aspect selection

- 1 Enter into **Special functions** menu.

Special functions	
Language	English
Blue back	On
Rotate	30
Aspect	4:3
Child lock	Off
Color system	Auto
Sound system	B/G

- 2 Press **CH+/-** to select **Aspect**.

- 3 Press **VOL+/-** to select picture size (ratio) between 4:3 and 16:9 according to your preference.

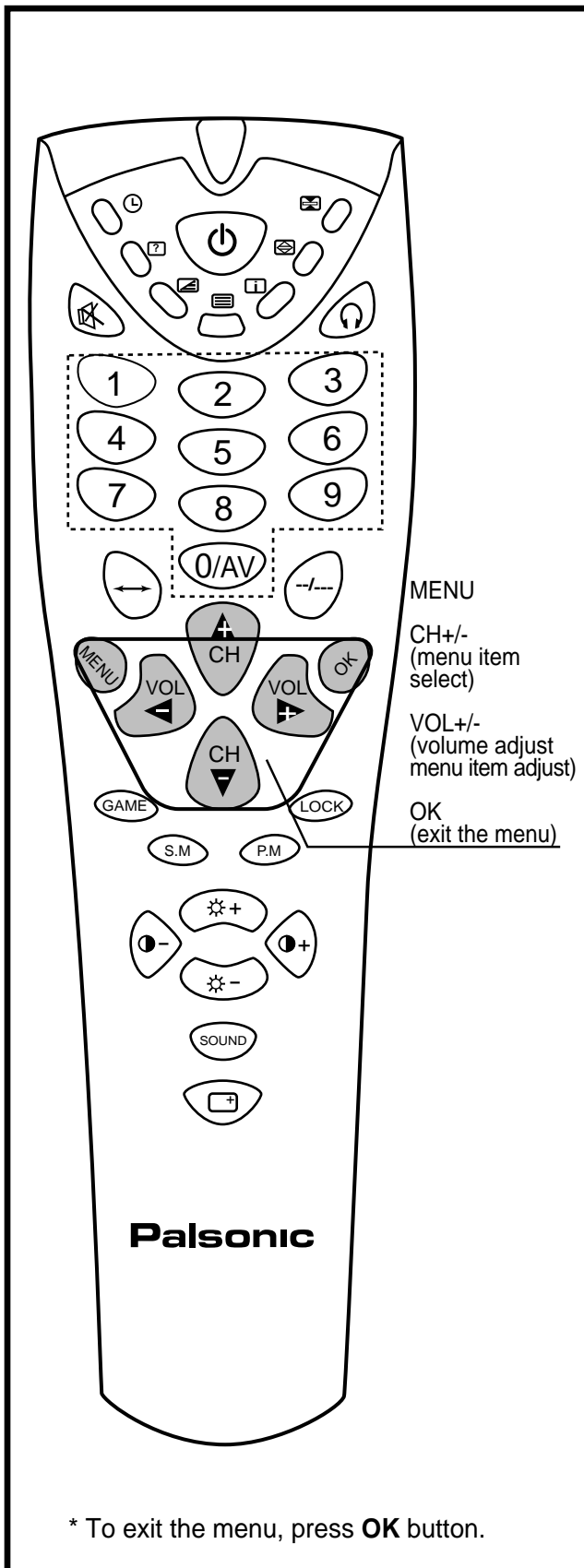

Child lock setting

* Child lock is an optional function.

Child lock setting

Making use of child lock function, you can lock all the programs to prevent children from viewing them.

- 1 Press **LOCK** button on the remote control, the Lock menu bar appears.
(or press **MENU** repeatedly to display **Special functions** menu. Press **CH+/-** to select **Child lock** item, then press **VOL+/-** to enter.)

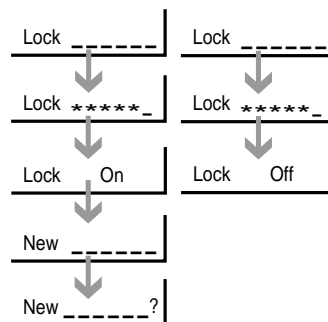

- 2 Input the correct password. (6-digit, the preset password is 123456). After inputting, the screen displays "**Lock: On**".
- 3 After one or more seconds the screen will display "**New** _____", now press **OK** button (or wait for some time until "New _____" disappear) and the child lock function is active now, the screen only displays blue back with Lock menu bar.
- 4 To unlock, input the correct password to set the Child lock to OFF.

Note: the preset password can be changed, the steps are shown below:

After you set the lock to On (or Off), the screen will display "New _____", input the new password, and confirm again. Now the password has been changed. But make sure to remember the new password.

In child lock OFF mode, if you press LOCK button unintentionally, you can press **OK** button to exit.

In child lock ON mode, buttons on the TV set can not act. Also most buttons on the remote control can not act.

To avoid forgetting the password, write it down here:

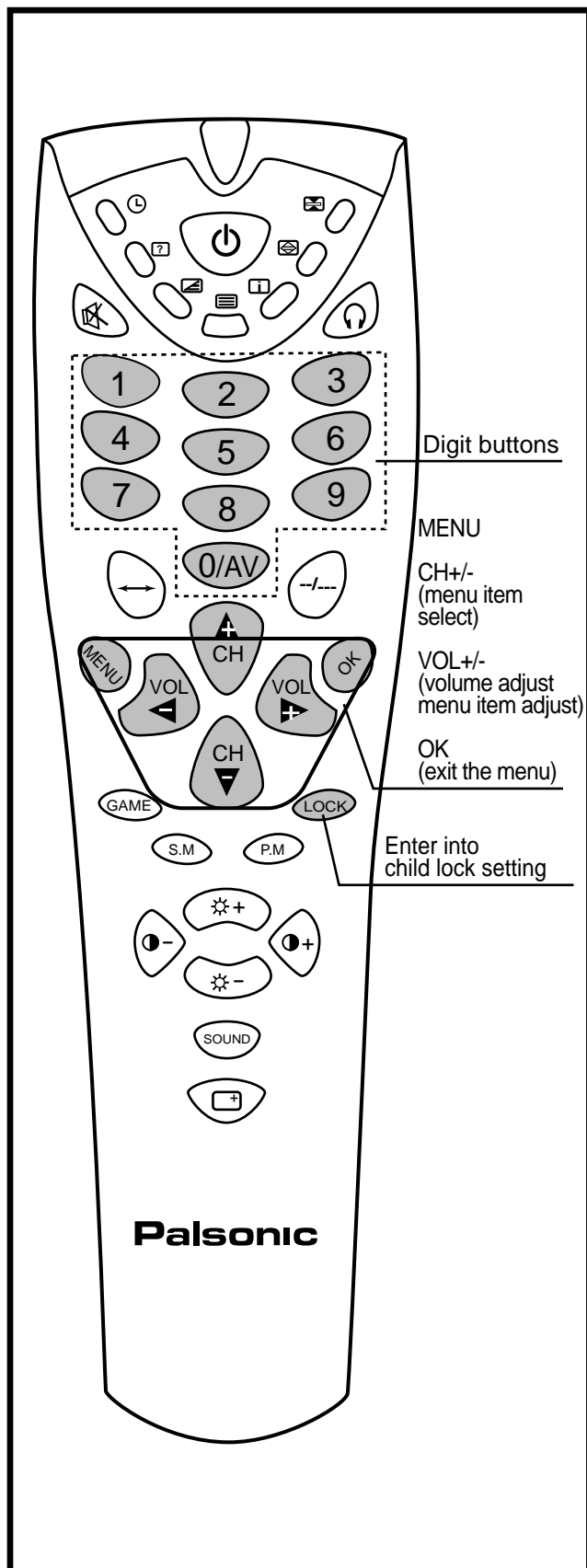

Hotel lock setting

* Hotel lock is an optional function.

Hotel lock setting

Making use of hotel lock function, you can limit some functions so that other user can not change your settings. This function is especially useful in hotel.

- 1** Press $\star+$ button on the remote control, the screen will display "Hotel -----".
- 2** Input the 6-digit password (the preset password is 123465), the screen will display "Hotel Off (or On)".
- 3** Press **VOL+/-** to select **ON**.

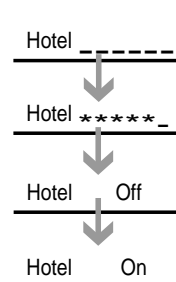

Now Hotel Lock function is active now. Only some buttons (for example, channel select buttons, volume control buttons, AV button, etc.) can act and the volume is limited. In Hotel ON mode, the maximum volume level is the level you set just before you enter the Hotel ON mode. If you want to change the volume limitation, set the Hotel to OFF and then adjust the volume, then enter into ON mode again.

To exit the hotel lock, set Hotel to **OFF**.

To clear the On-screen display, you can press **OK** button.

To change Hotel Lock password

The preset password for hotel lock can be changed, the steps are shown below:

- 1** After setting Hotel to OFF mode, press **MENU** button, the screen displays "New -----".
- 2** Input the new Password and confirm again.
Now the password has been changed.

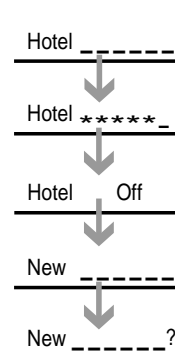

To avoid forgetting the password, write it down here:

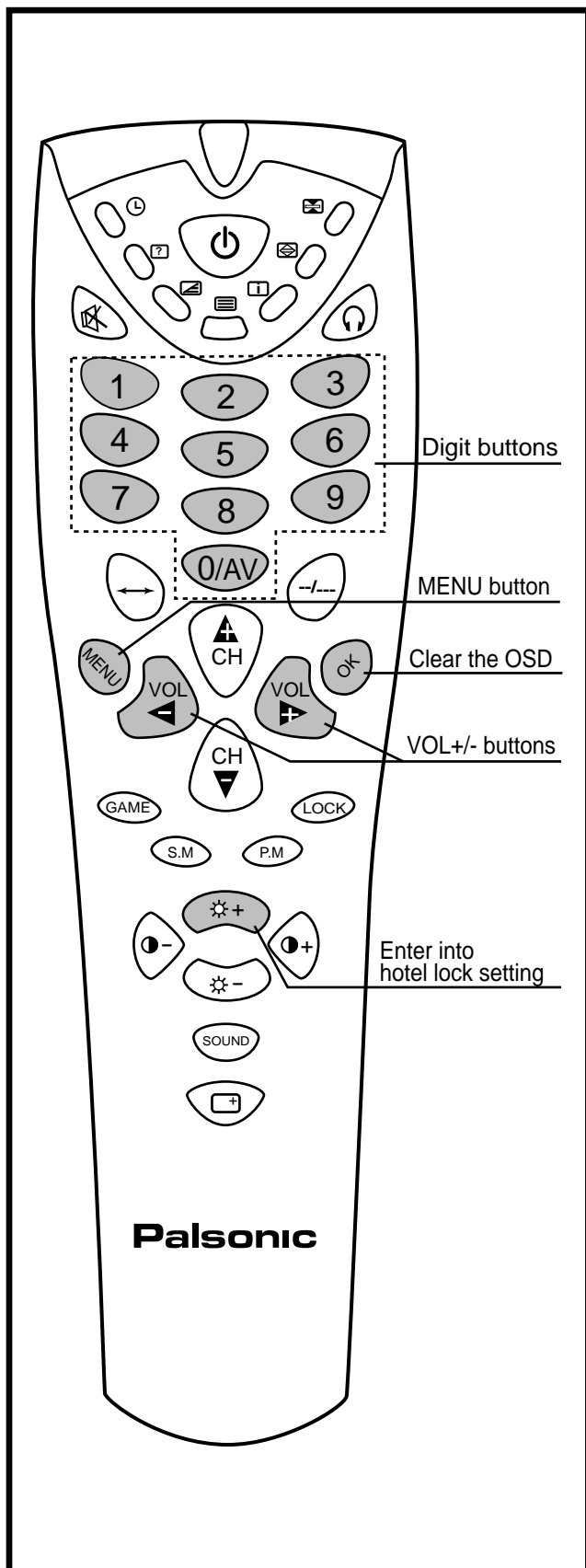

Game playing

To play game (card game)

- 1 Press **GAME** button to enter.
- 2 Press **MENU** button to select level.
There are five levels for you to select. The higher the level, the more difficulty the playing.
- 3 Press **CH+/CH-/VOL+/VOL-** button to select card, press **OK** button the card will be turned over. If the second card you turned over is different with the first card, it will cover again unless the same two cards are selected. Only you turn over all the cards, you win the game.
- 4 Press **GAME** button to exit.

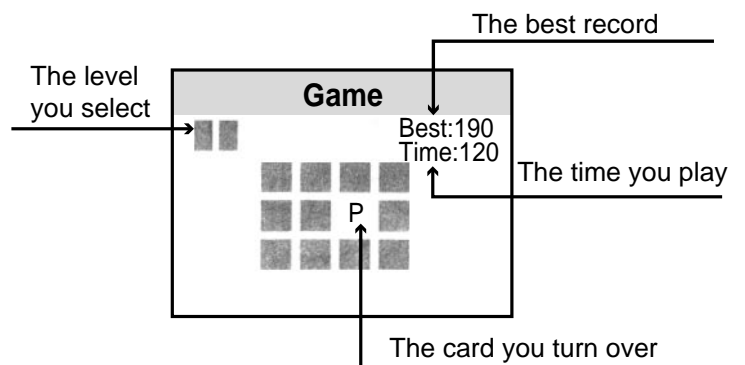
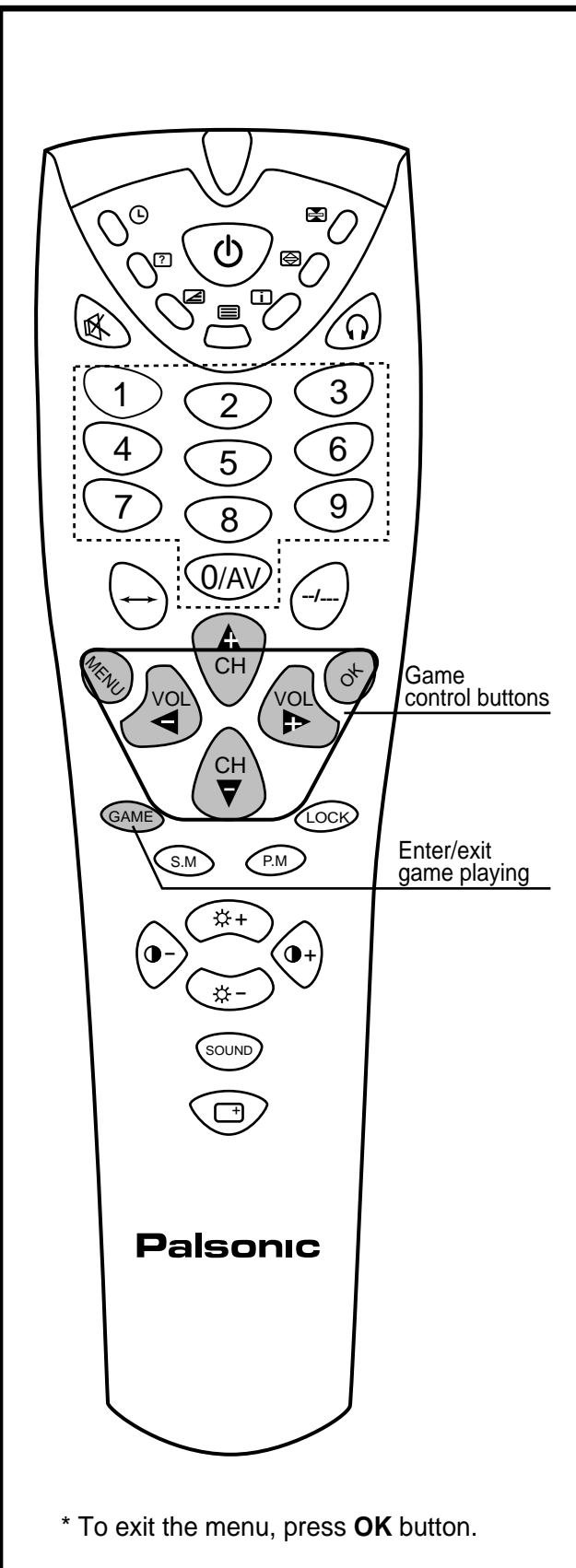

Teletext

Teletext is an optional function, therefore only a set with the teletext system can receive the teletext broadcast.

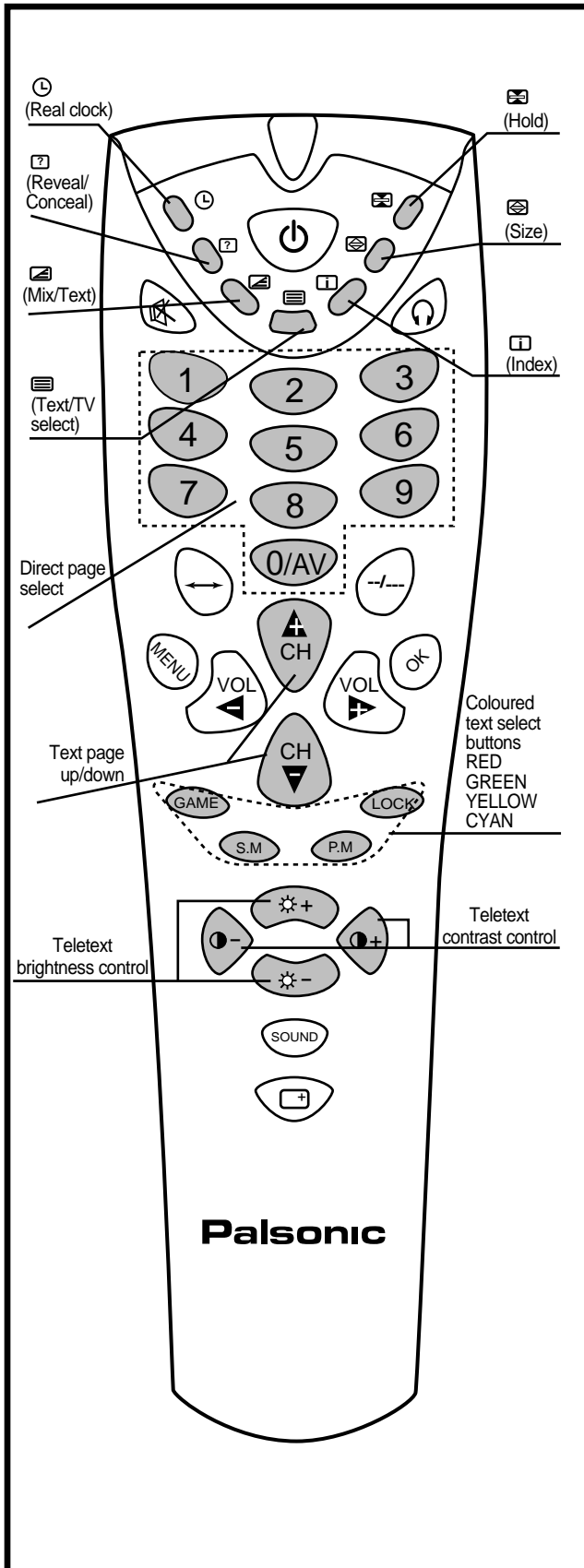

Switching Teletext on/off

Press button once to switch on teletext.
Press button twice both teletext and TV program are displayed.
Press button third time to switch off the teletext.

Description of Teletext

Teletext is a free service broadcast by most TV stations which gives up-to-the-minute information on news, weather, television programs, share prices and many other topics. The thing to remember about Teletext is that it is slow. It is the nature of the system itself, where a large amount of information is sent using a small fraction of the TV signal. If you get yourself into trouble, read the following instruction carefully. It may have your answer. Teletext is controlled through the remote controller.

Button introduction

1. (TEXT)

Press button to bring the set from TV mode to Teletext mode. Press it at the third time to resume TV mode.

2. (MIX)

Press the button, the text will be superimposed on a TV picture. Press again to restore text.

3. (INDEX)

In teletext mode press the button, the index page will appear.

4. (REVEAL)

Some pages have sections that are concealed such as the answers to riddles or puzzles. To see the concealed part, press the button. Press it again to conceal.

5. (HOLD)

To hold the current teletext page, press the button. To release the page press the button again.

6. (SIZE)

Press the button to expand the top half of the display. Press it again to expand the bottom half of the display. Press it once more to resume normal size.

7. (REAL CLOCK)

Press the button to display the real time on the screen while viewing TV program which carries a teletext broadcasting. Press again to turn off the time display.

8. RED/GREEN/YELLOW/CYAN buttons

(corresponds to GAMES/S.M/P.M/LOCK button)

These four colour-coded buttons control a memory that allows instant access to the displayed corresponding page number.

9. +/- buttons

Press the buttons to adjust Teletext brightness.

10. +/- buttons

Press the buttons to adjust Teletext contrast.

Special Functions

Before calling service personnel, please check the following chart for a possible cause to the trouble you are experiencing.

Symptoms	Check the following items
Power is not turned on	<ul style="list-style-type: none"> <input type="checkbox"/> Be sure the power cord is plugged in.
Poor colour poor tint	<ul style="list-style-type: none"> <input type="checkbox"/> Contrast, colour tint are not correctly adjusted
Spots appear on the screen	<ul style="list-style-type: none"> <input type="checkbox"/> Possible interferences of automobiles, motorcycle, trolley bus, neon lamps, etc.
Stripes appear on the screen	<ul style="list-style-type: none"> <input type="checkbox"/> Possible interference of electronic interference from another TV set, a computer, an electronics game machine, a broadcast station, etc.
Double images or "ghosts"	<ul style="list-style-type: none"> <input type="checkbox"/> This may be caused by reflections from nearby mountains or buildings. <input type="checkbox"/> Check the antenna direction.
Snowy picture	<ul style="list-style-type: none"> <input type="checkbox"/> It is possible that the aerial "lead-in" is damaged or comes off. <input type="checkbox"/> Check the antenna direction.
The screen only displays blue back. Buttons on the TV set can not act.	<ul style="list-style-type: none"> <input type="checkbox"/> The set may be in child lock ON mode. Use LOCK button and password to unlock it. If you forget the password, you can contact our company or the dealer.
Only some buttons have function while others can not act, and the volume is limited.	<ul style="list-style-type: none"> <input type="checkbox"/> The set may be in hotel lock ON mode. Set hotel lock to OFF. If you forget the password, you can contact our company or the dealer.
TV cabinet creaks	<ul style="list-style-type: none"> <input type="checkbox"/> Even if the picture or the sound is normal, changes in the room temperature sometimes make the TV cabinet expand or contract, making a noise. This does not indicate a malfunction.
Remote controller does not work	<ul style="list-style-type: none"> <input type="checkbox"/> The batteries may be worn out. <input type="checkbox"/> The batteries may be installed with their polarity reversed.
Unevenness in colour in some parts of the screen	<ul style="list-style-type: none"> <input type="checkbox"/> When the set is switched on, do not shift or move the set around. Sometimes it may develop an unevenness in colour in some parts of the screen. This can be eliminated by switching off the set with the POWER switch and wait for 30 minutes before switching on again.

Troubleshooting Guide

Reception disturbances

Most types of television interference can be remedied by adjusting the height and position of the VHF/UHF antenna. Outdoor antennas are recommended for best results if not using cable. The most common types of television interference are shown below. If one of these symptoms appear when the TV is connected to a Cable TV system, the disturbance may be caused by the local cable company broadcast.

IGNITION:

Black spots or horizontal streaks may appear, picture, may flutter or drift. Usually caused by interference from automobile ignition systems, neon lamps, electric drills and other electric appliances.



GHOSTS:

Ghosts are caused by the television signal following two paths. One is the direct path and the other is reflected from tall buildings, hills or other objects. Changing the direction or position of the antenna may improve the reception.



SNOW:

If your receiver is located in the fringe area of a television station where the signal is weak, your picture may be marred by the appearance of small dots. When the signal is extremely weak, it may be necessary to install an external antenna to improve the picture.



RADIO FREQUENCY INTERFERENCE:

This interference produces moving ripples or diagonal streaks, and in some cases, causes loss of contrast in the picture.



PICTURE SIZE VARIATION:

A slight picture size variation is quite normal when you adjust the CONTRAST or BRIGHTNESS setting.

CARE AND MAINTENANCE

To prevent fire or shock hazard, disconnect your unit from the AC power source when cleaning. The finish on the receiver may be cleaned with a dust cloth and cared for as other furniture. Use caution when cleaning and wiping the plastic parts. Mild soap and a soft, damp cloth may be used.

Specifications

Power Supply: AC 240V, 50Hz
Power Consumption: 180W
Dimensions (mm): 800 (W) x 595 (H) x 511 (D)
Weight (kg): 47
CRT: 68cm

TV system & channel range

System	VHF	UHF	CATV
PAL-B/G	2-12	21-69	X~Z+2, S1~S41

TELETEXT: WST TELETEXT
Colour System: PAL-BG, NTSC(AV)
Stereo/bilingual system: NICAM-BG, IGR-BG
Sound output: 7WX 2

Note: Design and specifications are subject to change without notice.

PALSONIC CORPORATION PTY LTD
1 JOYNTON AVENUE
WATERLOO NSW 2017 AUSTRALIA
TEL: (02) 9313 7111
FAX: (02) 9313 7555
www.palsonic.com.au

**PALSONIC CUSTOMER SERVICE
TELEPHONE
AUSTRALIA: 1300 657 888**

604-TA29513-00

Free Manuals Download Website

<http://myh66.com>

<http://usermanuals.us>

<http://www.somanuals.com>

<http://www.4manuals.cc>

<http://www.manual-lib.com>

<http://www.404manual.com>

<http://www.luxmanual.com>

<http://aubethermostatmanual.com>

Golf course search by state

<http://golfingnear.com>

Email search by domain

<http://emailbydomain.com>

Auto manuals search

<http://auto.somanuals.com>

TV manuals search

<http://tv.somanuals.com>