

OWNER'S MANUAL

PURE FLAT HI-VISION STEREO TELEVISION

Palsonic

80CM CORDLESS REMOTE COLOUR TELEVISION
MODEL: 8040PFST



Type Tested
Electrical
Safety

AS/NZS 3250 Lic 4166
Standards Australia
APP No: N15900

PALSONIC CORPORATION PTY LTD
1 JOYNTON AVENUE
WATERLOO NSW 2017 AUSTRALIA
TEL: (02) 9313 7111
FAX: (02) 9313 7555
www.palsonic.com.au

**PALSONIC CUSTOMER SERVICE
TELEPHONE
AUSTRALIA: 1300 657 888**

Main features

- **PAL/NTSC/SECAM Multi-System Hyperband**
- **Hyperband**
- **English/Chinese on-screen menu display**
- **Surround sound and wide - field dynamic sound system**
- **NICAM Digital Stereo/bilingual broadcasts receivable**
- **German Stereo (IGR)/bilingual broadcasts receivable**
- **Three groups of S-VIDEO/VIDEO/AUDIO input terminals and one group of MONITOR output terminals**
- **Auto/manual search**
- **OFF timer and ON timer, Auto-Power-Off & blue background display**
- **Advanced 6D picture improvement circuit**
 1. **Digital Colour Transient Improver (CTI)**
Enhance the tint and make the original picture brighter and fresher.
 2. **3H digital comb filter**
To attain the complete separation of brightness and colour signals. To reduce colour interface, blurry and dotted interruptions. To make the picture clearer.
 3. **Digital Luminance Transient Improver (LTI)**
Adopts the digital delay line and achieves the outline correction. To make the picture clearer and better definition.
 4. **Black level stretch circuit**
To extend the dynamic scope of the picture.
 5. **Scan Velocity Modulation & white peak suppressed circuit**
To enhance lines and borders-between bright and dark images. To improve the focus of the picture white peak and white characteristics, to make the picture and letters brighter and clearer.
 6. **Dynamic Focus**
To optimise the focus of electron beams in the CRT. To improve the picture sharpness especially in the comers of the screen and achieve the perfectness of picture finally.

Congratulations on your purchase of this colour PURE FLAT Hi-Vision
Palsonic television receiver.

We recommend that you thoroughly read this manual before use to fully enjoy the many functions and excellent effects of this receiver.

Retain this manual in an easily accessible location for future reference.

Contents

Main features	1
Notes for operation	2
Installation and appearance	3
Antenna connection	3
Battery installation	3
Appearance	4
The remote controller	5
Operation	6
Switching on/off	6
Presetting channels	7
Channel selection	10
Sound mode selection	11
Picture and sound adjustment	12
Other functions	15
External equipment connections	17
Trouble shooting	19
Specifications	20

NOTES FOR OPERATION

* Do not let the TV set be in standby condition for a long period of time. When it is not in use, please turn off the power supply and remove the power plug. When it is to be left for a prolonged period of time, it is recommended to disconnect the connection to the outdoor aerial, to avoid thunder strike.

* Please follow cautions for safety in the TV set instructions, and all warnings and descriptions denoted on the TV set.

■ Cautions For Safety

Note: This TV set can be operated on an AC power of 240V, 50Hz. You should not use power supply of the other type.

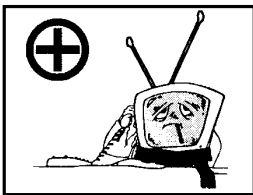

When an unusual situation occurs, turn off the power switch at once and remove the plug from the wall outlet. Contact a qualified service department in your local area.

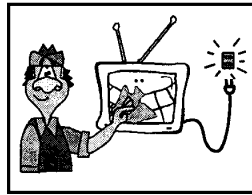

In order to wipe dust off the picture tube or off the cabinet, you should remove the power plug from the wall outlet first. You can wipe lightly with a piece of dry, clean, soft cloth.

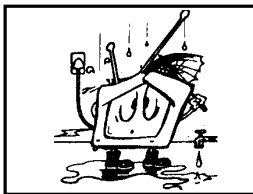

Do not expose the TV set to rain or excessive moisture, to prevent tire disaster or electric shock. Avoid using the set in very warm or damp places. Never use it in a bathroom.

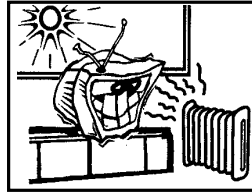

The TV set should be placed on an adequate place without exposing it to direct sunlight and other sources of heat to prevent the deformation of the cabinet or damage to components.

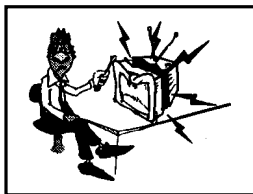

There exists High Voltage in this TV set. Do not remove the cover to avoid danger.

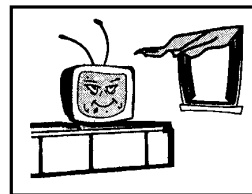

Do not cover the Ventilating holes in the cabinet. Keep a space of more than 5cm from the walls to the TV set, to guarantee the good ventilation.

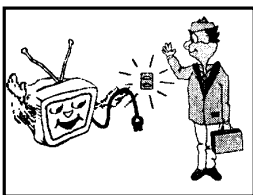

When the TV set is to be left unattended, please turn off the power switch and remove the plug from the wall outlet.

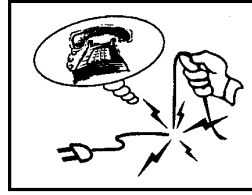

When the power cord or the plug is damaged, please contact a qualified service department to get service.

Installation and appearance

■ Antenna connection

To ensure a bright-coloured and clear picture, you should use an outdoor aerial or CATV cable. If the signals are strong enough, you may use an indoor aerial.

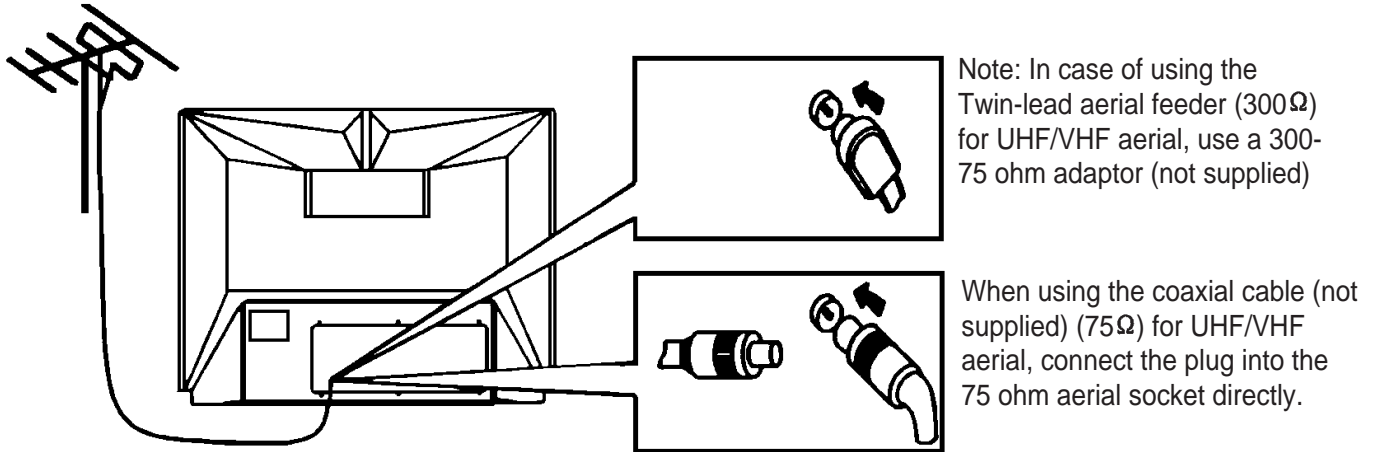

Note:

When you connect the outdoor aerial cable to the aerial terminal on the TV set, please turn off the power switch on the TV while connecting the antenna lead. In thunder and lightning, weather, please disconnect the connection to the outdoor aerial to avoid thunder/lightning strike.

■ Battery Installation:

1) Remove the back battery cover.

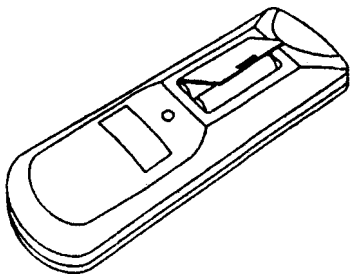

2) Insert two size AAA batteries according to the polarity indication inside the remote controller.

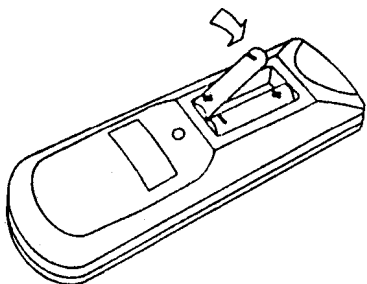

Effective range of the remote control operation

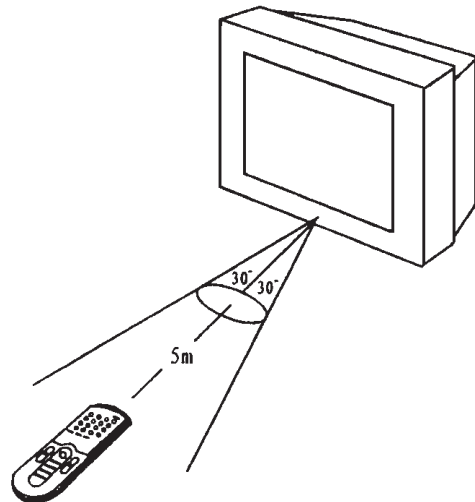

1. When the remote controller is not used for an extended period of time or the batteries are worn out, please remove the batteries in time to avoid battery leakage.
2. Avoid moisture and mechanical shock to the remote controller.

■ Appearance

Front view

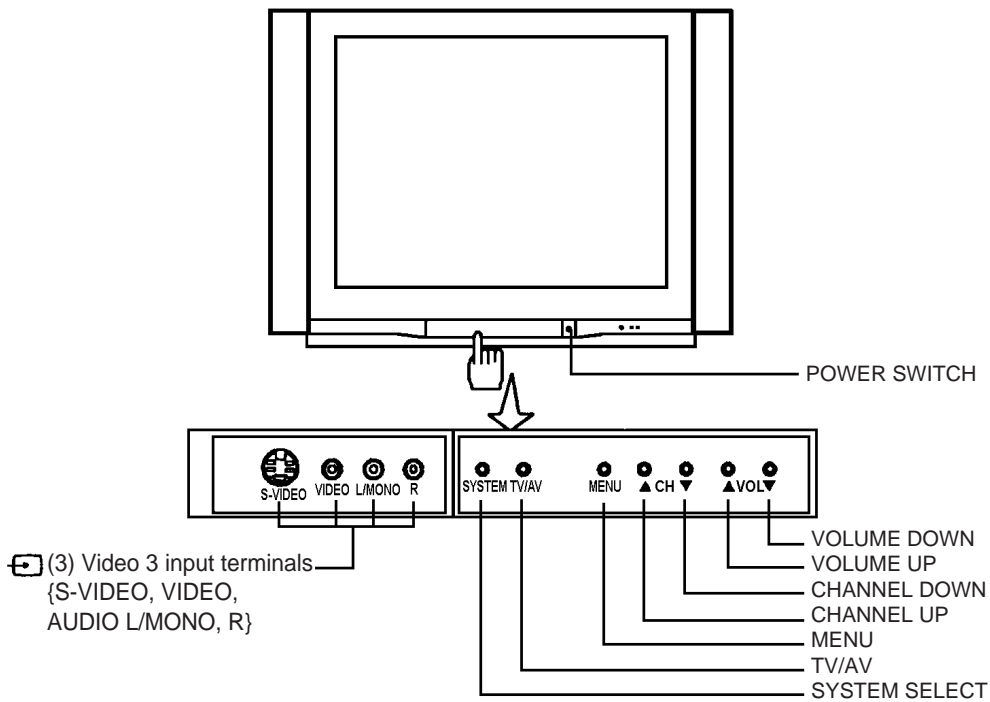

Note: Functions of MENU, TV/AV, SYSTEM, VOL ▲/▼, CH ▲/▼ are also provided to the remote controller.

Back view

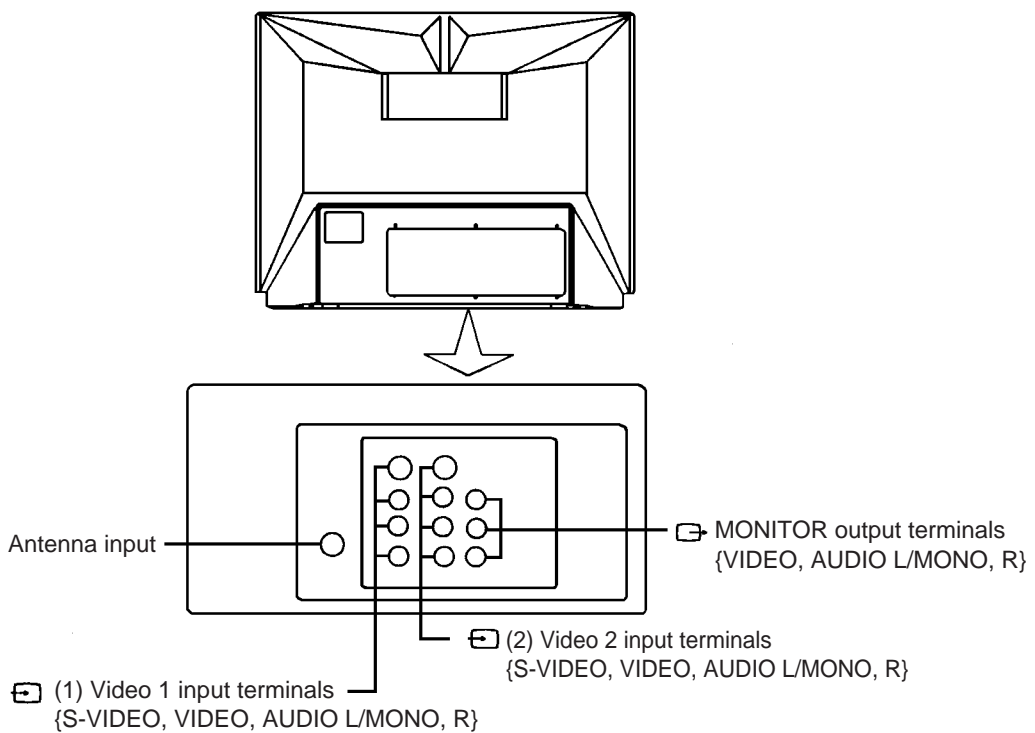

The Remote Controller

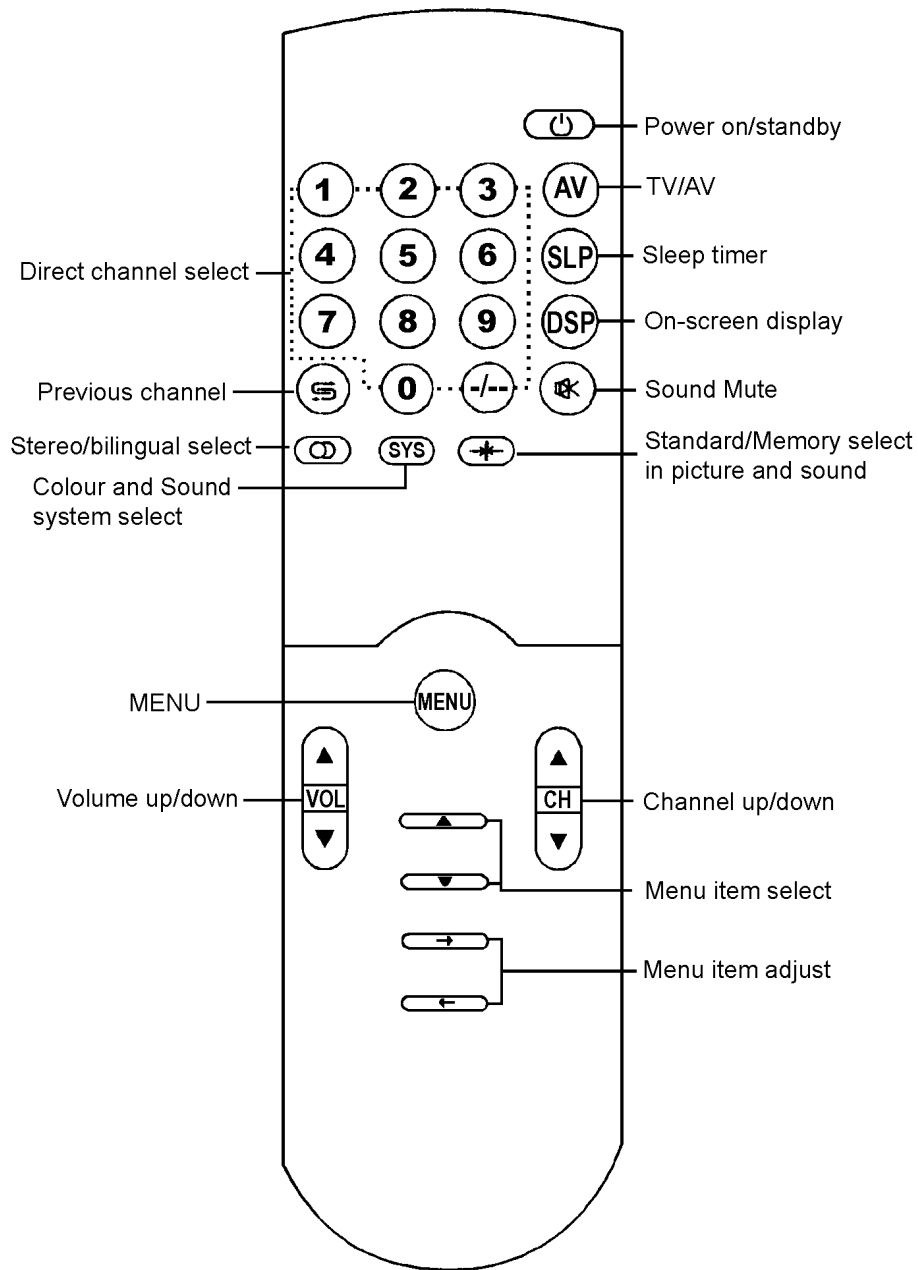

Operation

■ Switching on/off

1. Push the main power switch on, if the set is in Standby mode, the power indicator is red; If there are pictures appearing on the screen, the indicator is yellow.
2. If no picture appears on the screen, push the power button on the remote controller to turn the set on, the indicator turns to yellow.
Without using the remote controller, you can push any of the VOL ▲/▼, CH ▲/▼ or VIDEO button to turn on the TV.

Note: If there are no input signals to the TV when the TV is on, a blue background will appear on the screen. After 15 minutes if there are still no signals to the TV, it will enter into standby mode automatically.

3. Push the main power switch to turn off the set.
4. If you want to turn off the TV temporarily, push the ⏻ button on the remote controller to switch the set to standby mode, the indicator turns to red.

Special indication:

Last-Mode-Memory: after turning off the power, the last TV mode picture and sound setting mode and preset channels all are memorised. Therefore, the next time you turn on the TV, the TV will work in the previous setting mode.

- If you directly pressed the main power switch on the TV to turn it off, you must press the main power switch to turn on the TV.
- If you pressed the main power switch to turn off the TV when in standby mode, press the main power switch and then operate from the remote controller to turn the TV on.

Auto-Power-off function: there are two kinds of Auto-Power-Off function:

1. If a vacant channel is tuned or TV broadcast for a day is finished, the TV will automatically turn off after about 15 minutes.
2. OFF - timer function. However, if the OFF - timer is operating, it takes precedence, that is, the function of Auto-Power-Off, if no signals received will be ineffective.

■ Presetting the channels

There are two ways to preset channels: to preset channels automatically and to preset channels manually. Below we will describe how to preset the channels by making use of the menu.

1. To enter into menu

- 1.1 Press the **MENU** button to enter into the main menu.
- 1.2 Press menu item select button ▲ or ▼ to select **SEARCH**.
- 1.3 Press the → or ← button to enter into the sub-menu of **SEARCH**.

Note: The MENU button refers to the **MENU** button on the remote controller or on the TV set, the ▲ or ▼ button refers to the ▲ or ▼ button on the remote controller or CH ▲/▼ on the TV set, the → or ← button refers to the → or ← button on the remote controller or the VOL ▲/▼ button on the TV set.

2. AUTO SEARCH

- 2.1 Press the menu item select button ▲ or ▼ to select **AUTO SEARCH** (the caption on the screen is red).
- 2.2 Press → or ← button, the TV begins to search TV channels automatically. All active channels will be preset and stored into the memoriser automatically. After presetting, the TV will return to the first channel program.

Note: Before auto - search begins, you had better press "**SYS**" button to set the current sound system to B/G and the colour system to "AUTO".

↓ Press the MENU button to display the main menu



↓ Press the ▲ or ▼ button to select SEARCH

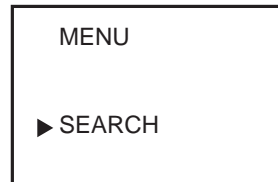

↓ Press the → or ← button to display the sub-menu of SEARCH

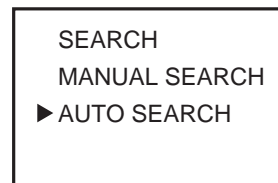

↓ Press the ▲ button to select AUTO SEARCH

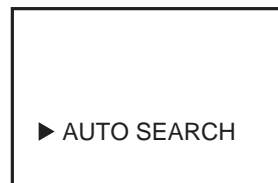

↓ Press the → or ← button it begins searching automatically

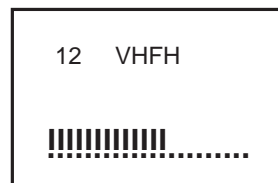

↓ After presetting is finished it returns to the first channel

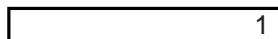

3. MANUAL SEARCH

If AUTO-SEARCH cannot preset the desired channels, or you want to preset the desired channels one by one with the preferred channel numbers - please make use of MANUAL SEARCH.

3.1 Press the menu item select button ▲ or ▼ to select **MANUAL SEARCH** (the caption on the screen are red).

3.2 Press the → or ← button to enter into the sub-menu of **MANUAL SEARCH**.

3.3 Press the ▲ or ▼ button to choose **POSITION**. (the caption on the screen are red), press the → or ← button to select the needed program number (from 00 ~ 99).

Note: Push the → or ← button to select a channel number within 0.7 of a second. Push and hold the → or ← button for more than 0.7 of a second to select a decimal number.

3.4 Press the ▼ or ▲ button to select **SEARCH**, push the → button to search channels from current channel to higher channel. Push the ← button to search channels from current channel to lower channel. When a channel is located, the searching stops, this channel is then memorised with a present channel number.

Note: You can also make use of band selection to quicken the searching process in your desired band. Pressing the → or ← button moves the band to the next step in the sequence below.

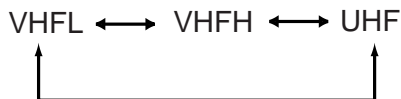

↓ Press the ▲ or ▼ button to select MANUAL SEARCH

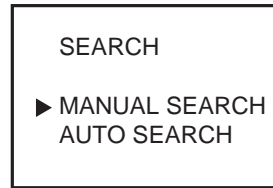

↓ Press the → or ← button to display the menu of MANUAL SEARCH

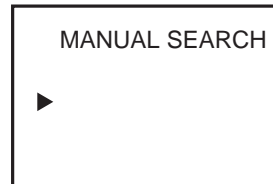

↓ Press the ▲ or ▼ button to select SEARCH

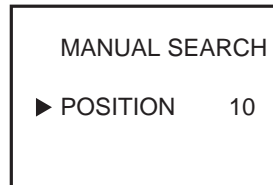

↓ Press the → button to select the wanted channel number

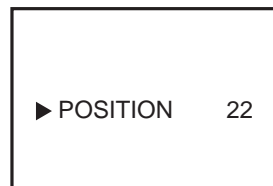

↓ Press the ▲ button select SEARCH

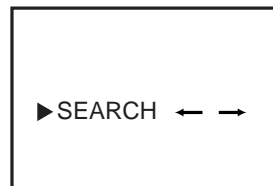

↓ Press the ▼ button it begins searching

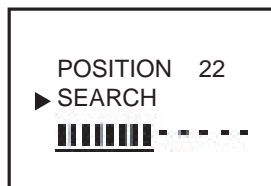

↓ When a station is searched the searching stops

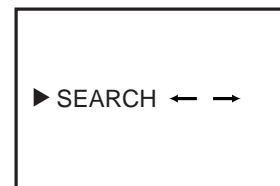

3.5 When you want to store and memorise another channel with another position, repeat steps 3.3, 3.4.

4. Skip unwanted program numbers

After presetting the channels, you can skip unwanted program numbers to select your desired channels.

4.1 Repeat steps 3.1 to 3.3 to select the unwanted program position of the unwanted channels .

4.2 Press the ▲ or ▼ button to select **SKIP**. Press the → or ← button to select **SKIP ON**.

After completion of the channel presetting, when you press the CH ▲/▼ button to select channel, the unwanted channels will be skipped.

If you want to skip other unwanted channels, repeat step 4.1 above to change the channel numbers.

If you want to restore the skipped program numbers, do step 4.1 to select these program numbers, then press the → or ← button to select **SKIP OFF**.

5. Manual Fine Tuning

When sound and picture's effect of a channel is poor (for example: one or two CATV channel's sound and picture are not standard), you can correct by the use of Manual Fine Tuning.

5.1 Repeat steps 3. 1 to 3.3 to select the channels you want to manually fine tune.

5.2 Push the ▲ or ▼ button to select **MFT**, then press → or ← button, the channel begins to search until the optimum picture and sound is achieved.

Note:If some channel's colour or sound is abnormal, it may be that the setting of the colour or the sound system is wrong, please do the following step 6 to set the colour and sound system.

After finishing the preset operation, press the **MENU** button repeatedly until the "on - screen" display disappears and exits from the main menu.

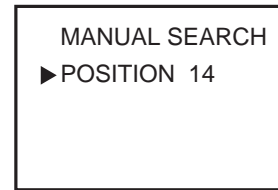

↓ Press the ▼ button to select SKIP

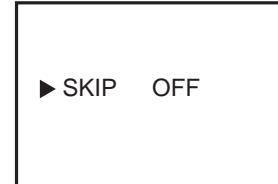

↓ Press the → or ← button to select SKIP ON

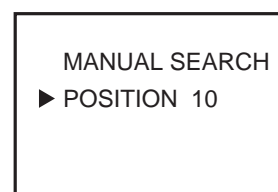

↓ Press the ▼ button to select MFT



↓ Press the → button it begins fine tuning in → direction.

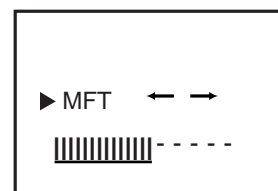

↓ Press the MENU button repeatedly until on-screen display menu disappears

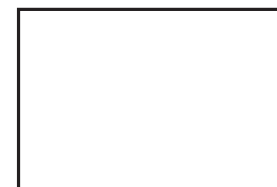

6. The setting of colour and sound system

6.1 Press the **SYS** button, the screen will display colour and sound system.

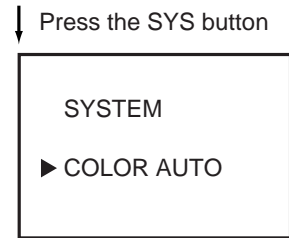

6.2 If the displaying colour is abnormal, press the ▲ or ▼ button to select **COLOR**, then press the → or ← button to select the right colour system. Every time you press → or ← button, the colour system will change in the sequence on the right.

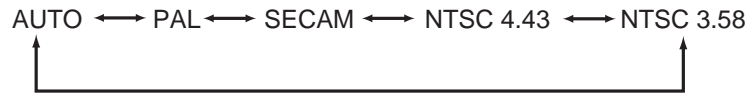

6.3 If the sound is abnormal, press the ▲ or ▼ button to select **SOUND**, then press the → or ← button to select the right sound system. The sound system will change in the sequence on the right:



Now you can watch the broadcasting TV program at the preset channel.

■ Channel selection

You can select your desired TV program by one of the following methods.

1. Making use of the direct select buttons 0 ~ 9 and - / -

To select a one - digit channel, press - / - button to display " - " on the upper right corner of the screen, then directly press a number button of 0 ~ 9. To select a two-digit channel, press the - / - button to display " - - " on the upper right corner of the screen, then press the number buttons. The channel range is 0 ~ 99.

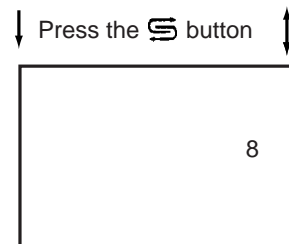
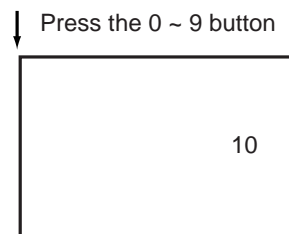
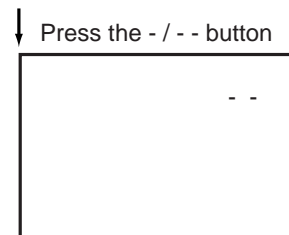

2. Making use of the CH ▲/▼ button

Press the CH ▲ button, the channel number will increase progressively. Press the CH ▼ button, the channel number will decrease progressively.

3. Making use of the S button

Press the S button, it can switch back quickly to the previous channel. For example, the channel you previously watched is 2, the present channel is 8, press the S button, it will return to channel 2, press the S button it will return to channel 8.

■ Sound mode selection

If the broadcasting TV station is transmitting high quality two-channel digital sound (NICAM) to be added to the already existing FM sound, or transmitting a second FM sound with an identification signal to be added to the already existing first FM sound (IGR), in the upper right corner of the screen will display an indication for several seconds which is listed in the following table. You can press the "Ⓞ" button repeatedly to select sound source.

	Sound transmitting mode		On - screen display and sound source
1	FM MONO Only one FM channel transmitting mono sound		
2	FM STEREO two FM channels transmitting stereo sound		
3	FM DUAL two FM channels transmitting dual language		
4	NICAM MONO one digital sound channel transmitting mono sound	FM MONO one FM sound channel (The sound signal in FM channel is same as the one in NICAM channel. So when the NICAM is transmitting, on the TV set automatically switches to high quality digital sound channel).	
5	NICAM STEREO two digital sound channels transmitting stereo sound		
6	NICAM DUAL two digital sound channels transmitting dual sound		
7	NICAM MONO one digital sound channel transmitting mono sound	FM MONO one FM sound channel (The sound signal in FM channel is different from the one in NICAM channel. So when the NICAM is transmitting on the TV screen only displays an indicator in yellow, while the active sound channel is FM).	"NICAM MONO" (In yellow. Only for indication) → "NICAM MONO" → "FM MONO" FM mono sound digital mono sound FM mono sound
8	NICAM STEREO two digital sound channels transmitting stereo sound		"STEREO" (In yellow. Only for indication) → "STEREO" → "FM MONO" FM mono sound digital stereo sound FM mono sound
9	NICAM DUAL two digital sound channels transmitting dual sound		"DUAL" (In yellow. Only for indication) → "DUAL 1" → "DUAL 2" → "FM MONO" language 3 language 1 language 2 language 3

If you experience loud noise in digital sound channel because of the weak signal, please press the "Ⓞ" button to set the sound mode to "FM MONO" or "FORCE FM", thus to select FM sound channel. In "FORCE FM" mode, the TV set no longer automatically searches "NICAM" or "IGR" signals.

Picture and sound adjustment

Press the →|← button, you can quickly select two modes of picture and sound quality standard: One is standard mode (on the screen displays ("STANDARD"); The other is personal select mode (on the screen displays "MEMORY").

1. Picture adjustment

Complete the following steps and you will adjust the picture quality.

- 1.1 Press the **MENU** button, on the screen will display the main menu, press the ▲ or ▼ button to select **PICTURE**, then press → or ← button to enter into the sub-menu of **PICTURE**.
- 1.2 Press ▲ or ▼ the button to select the items you want to adjust (the caption on the screen is red), then press the → or ← button to adjust the level of picture control amount.

Adjustment item	Pressing (Memory mode)		Standard Mode
	←	→	
COLOUR	paler	deeper	50
BRIGHT	darker	lighter	70
CONT (Contrast)	weaker	stronger	70
SHARP	weaker	stronger	20
TINT	purplish	bluish	0
BBK (Blue background)	ON (OFF)		ON

Note:

- * Only when the colour system is NTSC, there is TINT item.
- * If the signal being received is weaker, adjust SHARP to lower level to reduce the noise. If the signal being is stronger, adjust SHARP to higher level to improve the picture quality.
- * If the TV signals are too weak and you can not watch the program normally, blue background will appear automatically to overcome the picture. If you insist on watching the program, you can select "BBK" item to shut off the blue background. We suggest you turn "BKK" on in ordinary circumstances.

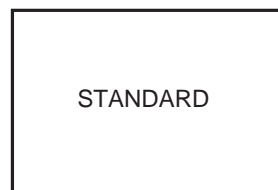

Press the →|← button

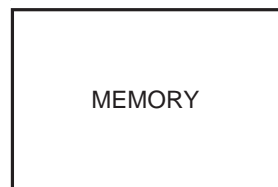

Press the MENU button to display the main menu



Press the → or ← button to display the menu of PICTURE



Press the ▼ or ▲ button to select adjustment item

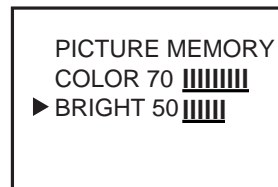

Press the → or ← button to adjust the level

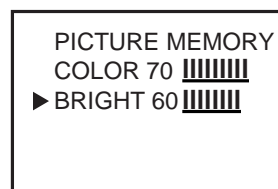

2. Sound adjustment

Complete the following steps and you will adjust the sound quality.

- 2.1 Press the MENU button to display the main menu. Press the ▼ or ▲ button to select SOUND, then press the → or ← button to enter into the sub-menu of SOUND.
- 2.2 Press the ▼ or ▲ button to select your required sound adjustment item (the caption on the screen is red), then press the → or ← button to adjust the sound quality.

Adjustment item	Pressing (Memory mode)		Standard mode
	←	→	
BASS	weaker	stronger	50
TREBLE	weaker	stronger	50
BALANCE	decrease right side sound	decrease left side sound	0
SURROUND	on/off	on/off	Off
SURROUND	weaker	stronger	50

You can select the sound quality according to the programme content and personal preference.

BASS	TREBLE	SURROUND	Tone quality
Strong	Strong	on	suitable for listening to music
weak	weak	off	suitable for listening to news, language
middle	middle	off	standard

Note: During the process of picture and sound adjustment, every time you press the → | ← button, **STANDARD/MEMORY** is displayed on the screen alternatively. When picture and tone quality are adjusted to your desired level, the mode is memory mode.

↓ Press the MENU button and ▼ button

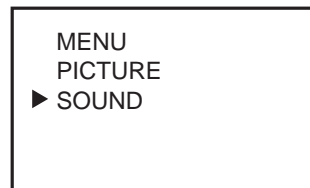

↓ Press the → or ← button to display the menu of sound

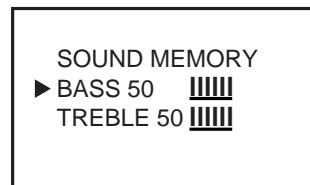

↓ Press the ▼ or ▲ button to select adjustment mode

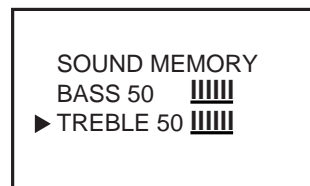

↓ Press the → or ← button to adjust the level

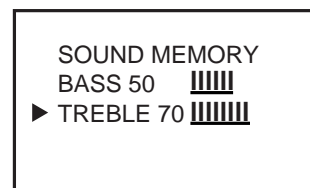

↓ Press the → | ← button mode changes between STANDARD and MEMORY

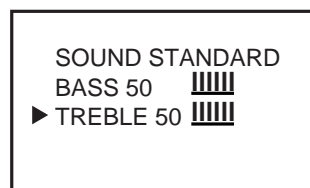

3. SURROUND SOUND

Making use of surround sound, you can enjoy the dynamic sound effect that is like being in a music hall. To make use of surround sound, complete steps 2.1, 2.2 to select **SURROUND ON**, and press the ▼ button to select **SURROUND** then press the → or ← button to adjust its effect. To turn off surround sound, select **SURROUND OFF**.

4. Adjusting the volume and muting the sound.

You can press the VOL ▲/▼ button to adjust the volume, and you can press the M button to mute the sound. Press the M button again or VOL ▲ button or operate any item of SOUND menu, the sound is restored to normal.

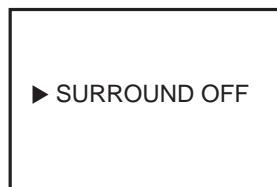
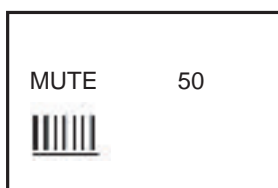

↓ Press the → or ← button to select SURROUND ON

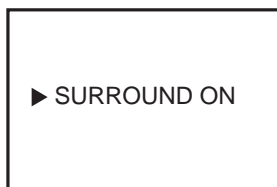

↓ Press ▼ button to select SURROUND

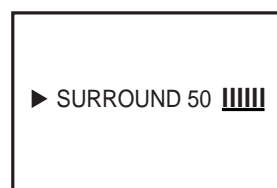

↓ Press the → button to increase SURROUND

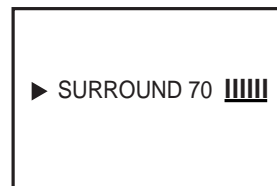

■ Other functions

1. ON Timer/OFF Timer

With the timer, you can set the TV to turn on/off automatically at a preset time. In the menu of **TIMER** you can set: **CLOCK**, **ON TIME**, **OFF TIME**.

1.1 OFF TIME

With the OFF timer, the TV will automatically switch to standby mode at a preset time.

1.1.1 Press the **MENU** button to enter into the main menu, press the **▲** or **▼** button to select **TIMER**, and press the **→** or **←** button to enter into the sub - menu of **TIMER**.

1.1.2 Press the **▲** or **▼** button to select **OFF TIME**. Pressing the **→** or **←** button set **ONCE/EVERY OFF TIME**. Every time you press the **→** or **←** button, it will change in the sequence of **OFF → EVERY → ONCE → OFF → EVERY** ----- . When the setting is **ONCE** or **EVERY OFF TIME**, press the **▲** or **▼** button to select time to turn off the set, then press the **→** or **←** button to set the time to turn off the TV, at the preset time the TV will automatically switch to standby mode. To cancel **OFF TIME**, set **OFF TIME OFF**.

menu of **TIMER**

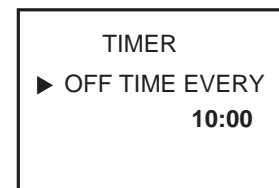
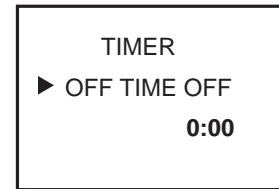

1.2 ON TIME

With the ON timer, the TV will automatically turn on to preset channel at a preset time.

1.2.1 Do Step 1.1.1 to enter into the sub-menu of **TIMER**

1.2.2 Press the **▼** or **▲** button to select **ON TIME**. Pressing the **→** or **←** button set **ONCE/EVERY ON TIME**. Every time you press the **→** or **←** button, it will change in the sequence of **OFF → EVERY → ONCE → OFF → EVERY** When the setting is **ONCE** or **EVERY ON TIME**, press the **▼** or **▲** button to select time to turn on the set, then press the **→** or **←** button to set the time to turn on the TV. After the setting, press the **▼** or **▲** button to select **POS.**, then press the **→** or **←** button to select your desired program number.

menu of **TIMER**







1.2.3. Pressing the  button set the TV into standby mode. At the preset time the TV will automatically turn on to preset channel. To cancel ON TIME, set ON TIME OFF.

1.3 CLOCK

The built-in clock employs the 24-hour system.

1.3.1 Do step 1.1.1 to enter into the sub-menu of TIMER.

1.3.2 Press the  or  button to select **CLOCK**.

Pressing the  or  button set the present hour and minute.

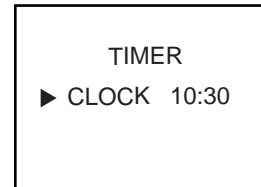

Note: To make use of ON TIME and OFF TIME, set the clock firstly and check the correct time.



1.4 SLEEP

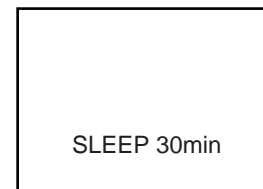



To make use of SLEEP function, press the **SLP** button every time, the letters displaying on the screen will change in the sequence of OFF → 120 min → 110min →10min → OFF..... At the preset time, the TV will automatically switch to standby mode.



2. Selecting the menu language

You can select the menu language: ENGLISH or CHINESE(中文).

2.1 Press the **MENU** button to enter into the main menu, press the  or  button to select **LANGUAGE**.

2.2 Press the  or  button to enter into the sub-menu. Press the  or  button to select **ENGLISH** or 中文

2.3 Press the **MENU** button repeatedly until the set exits from menu - display mode.



External Equipment Connections

The following describes how to use and connect the TV with other equipment. Refer to the owner's manual of the other equipment to be connected as well.

1. To Connect to AV input

You can video equipments such as a VTR and video camera to this TV and enjoy the high quality picture and sound.

If your video equipment has an S-VIDEO output terminal, connect it to the S-VIDEO input terminal (special S-VIDEO type) of the unit. If not, connect it to the VIDEO terminal (phono type).

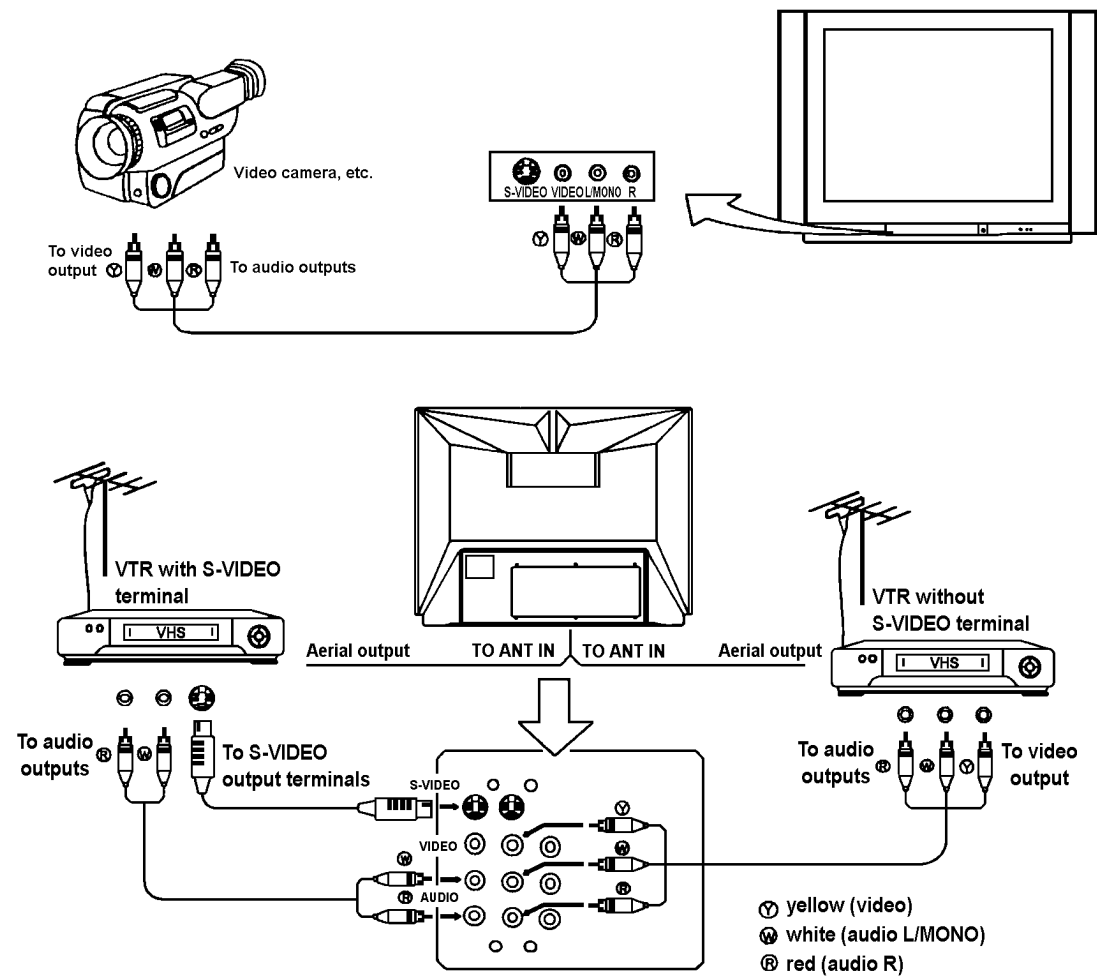

To select the input press the AV button on the remote controller repeatedly until you see the corresponding input indication on the screen. To return to aerial input, press the AV button until it displays programme number, or press direct channel select button or the CH ▲/▼ button.

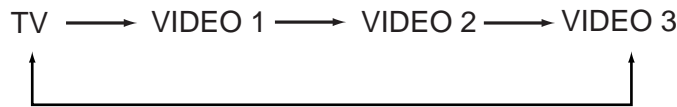

If the colour of video input is abnormal, the colour system setting may be incorrect. Press the SYS button to display COLOR AUTO. If not, press the → or ← button until normal colour appears.

Note on the S-VIDEO terminal

The **S-VIDEO** input terminal has priority over the AV1, AV2 VIDEO terminals on the rear and the AV3 VIDEO terminals on the left side. To use equipment connected to the video terminals, disconnect any plug from the **S-VIDEO** terminal.

2. To connect MONITOR output terminals

You can connect a stereo system to the **MONITOR** output terminals (photo type) on the set to enjoy a high - quality sound from the stereo system. The **MONITOR** output terminals output the video and audio signals being displayed on the screen.

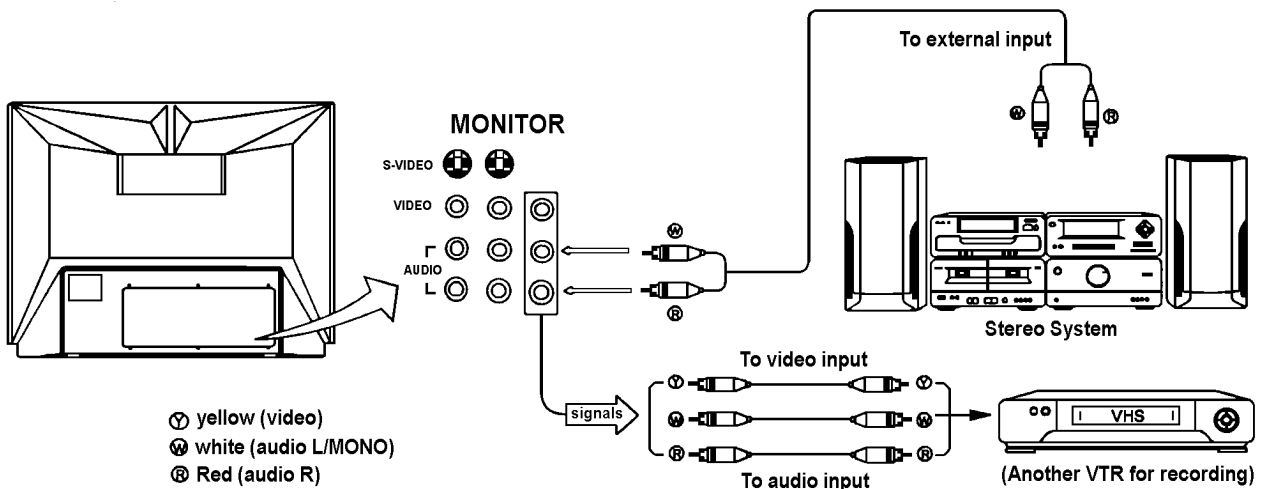

Troubleshooting

Symptoms	Check the following items
No power, red indicator is not lit up	<ul style="list-style-type: none">• Be sure the power cord is plugged in
Poor colour, poor tint	<ul style="list-style-type: none">• Contrast, colour, tint are not correctly adjusted
Spots appear on the screen	<ul style="list-style-type: none">• Possible interferences of automobiles, motorcycle, trolley bus, neon lamps, etc.
Stripes appear on the screen	<ul style="list-style-type: none">• Possible interferences of electronic interference from another TV set, a computer, electronics game machine, a broadcast station, etc.
Double images or "ghosts"	<ul style="list-style-type: none">• This may be caused by reflections from nearby mountains or buildings.• Check the antenna direction.
Snowy picture	<ul style="list-style-type: none">• It is possible that the aerial "lead - in" is damaged or comes off.• Check the antenna direction.
The remote controller does not work	<ul style="list-style-type: none">• The batteries may be worn out• The batteries may be installed with their polarity reversed.
TV cabinet creaks	<ul style="list-style-type: none">• Even if the picture or the sound is normal, changes in the room temperature sometimes make the TV cabinet expand or contract, making a noise. This does not indicate a malfunction.

Specifications

Power supply: AC 240V, 50Hz
Power consumption: 200W
Dimension (mm): 926 (W) x 678.5 (H) x 582 (D)
Weight: 73 kg
CRT: 80 cm

TV system & channel range

System	VHF	UHF	CATV
PAL-D/K	1-12	13-57	Z1 ~ Z37
PAL-B/G	2-12	21-69	X ~ Z + 2, S1 ~ S41
PAL-I	2-12	21-69	
NTSC-M US	2-13	14-79	
SECAM-B/G	2-12	21-69	A-6~A-I,A~W,AA~FFF
SECAM-D/K	1-12	21-69	X ~ Z + 2, S1~S4

Colour system: PAL/SECAM/4.43NTSC/3.58NTSC

Sound system : NICAM728: B/G 5.5/5.85

I 6.0/6.552

D/K 6.5/5.85

IGR(2 - Carrier) : B/G 5.5/5.74

Sound output: 13W + 13W

Accessories: one remote controller

Note : Design and specifications are subject to change without notice.

PALSONIC CORPORATION PTY LTD
1 JOYNTON AVENUE
WATERLOO NSW 2017 AUSTRALIA
TEL: (02) 9313 7111
FAX: (02) 9313 7555
www.palsonic.com.au

**PALSONIC CUSTOMER SERVICE
TELEPHONE
AUSTRALIA: 1300 657 888**

604-Z34183-00

Free Manuals Download Website

<http://myh66.com>

<http://usermanuals.us>

<http://www.somanuals.com>

<http://www.4manuals.cc>

<http://www.manual-lib.com>

<http://www.404manual.com>

<http://www.luxmanual.com>

<http://aubethermostatmanual.com>

Golf course search by state

<http://golfingnear.com>

Email search by domain

<http://emailbydomain.com>

Auto manuals search

<http://auto.somanuals.com>

TV manuals search

<http://tv.somanuals.com>