

OWNER'S MANUAL

Palsonic

**43CM CORDLESS REMOTE LCD TV/MONITOR
MODEL: TFTV435**



N111

**PALSONIC CORPORATION PTY LTD
1 JOYNTON AVENUE
WATERLOO NSW 2017 AUSTRALIA
TEL: (02) 9313 7111
FAX: (02) 9313 7555
www.palsonic.com.au**

**PALSONIC CUSTOMER SERVICE
TELEPHONE
AUSTRALIA: 1300 657 888**

Congratulation on your purchase of this **LCD TV**

We recommend that you read this manual thoroughly before use to fully enjoy the many functions and excellent features of this unit.

Keep this manual in an easily accessible location for future reference.

Note: Screen displays and illustrations in this manual may differ from the actual model.

Contents Index

Important Safety Cautions	1	Selecting channel	20
Identification of controls	4	Picture adjustment	21
Control buttons	4	Audio Setting	22
Back	5	System Setting	23
Remote control	6	OSD Setting,	24
Installation	8	Timer setting	25
Basic operations	5	Operations in RGB/YPbPr mode	26
Main OSD introduction	16	Troubleshooting	28
Operations	17	Specifications	29
Channel Setting	17		

Important Safety Cautions

When any unusual situation occurs, turn off the power supply at once and remove the plug from the wall outlet. Contact a qualified service department in your local area.

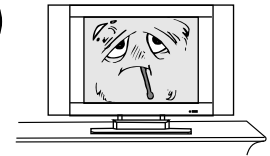

Water and moisture - Do not use this product near water - for example, near a bathtub, washbowl, kitchen sink, or laundry tub, in a wet basement, or near a swimming pool, and the like. Do not use immediately after moving from a low temperature to high temperature environment, as this causes condensation, which may result in fire, electric shock, or other hazards.



Heat sources - Keep the product away from heat sources such as radiators heaters, stoves other heat generating products (including amplifiers).
requirement of environment temperature;
0°C~50°C for storage; 5°C~40°C for working.

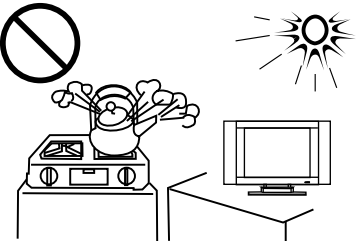

The vents and other openings in the cabinet are designed for ventilation. Do not cover or block these vents and openings since insufficient ventilation can cause overheating and/or shorten the life of the product.

Do not place the product on a bed, sofa, rug or other similar surface, since they can block ventilation openings.

This product is not designed for built-in installation; do not place the product in an enclosed place such as a bookcase or rack, unless proper ventilation is provided or the the manufacturer's instructions are followed.

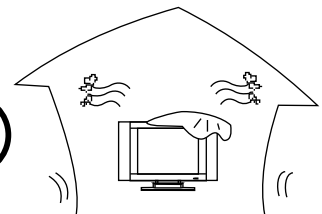

Unplug this product from the wall outlet before cleaning. Do not use liquid cleaners or aerosol cleaners. Use a damp cloth for cleaning.

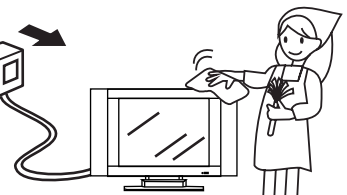

Do not place the product on an unstable trolley, stand, tripod or table. Placing the product on an unstable base can cause the product to fall, resulting in serious personal injuries as well as damage to the product. Use only a trolley, stand, tripod, and bracket or table recommended by the manufacturer or sold with the product.

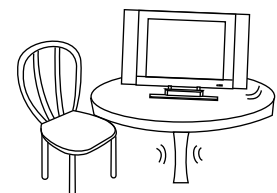

Important Safety Cautions

When relocating the product placed on a trolley, it must be moved with the utmost care. Sudden stops, excessive force and uneven floor surfaces can cause the product to fall from the trolley.



The power cords must be routed properly to prevent people from stepping on them or objects from resting on them. Check the cords at the plugs and product. Power supply cords should be routed so that they are not likely to be walked on or snagged by items placed upon or against them. Pay particular attention to cords at doors, plugs, receptacles, and the point where they exit from the product. If the power cord or the plug is damaged contact a qualified service department for service.

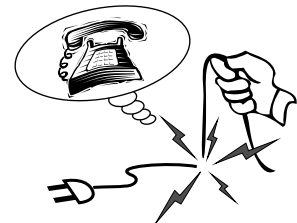

Do not overload wall outlets, extension cords, or convenience receptacles on other equipment as this can result in a risk of fire or electric shock.

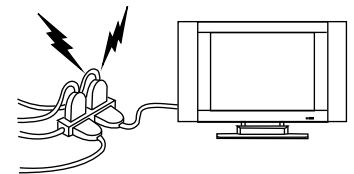

High Voltage exists in this TV set. Do not remove the cover. In case the product needs replacement parts, make sure that the service person uses replacement parts specified by the manufacturer, or those with the same characteristics and performance as the original parts. Use of unauthorised parts can result in fire, electric shock and/or other danger.



The LCD panel used in this product is made of glass. Therefore, it can break when the product is dropped or impacted upon by other objects. Be careful not to be injured by broken glass pieces in case the LCD panel breaks.

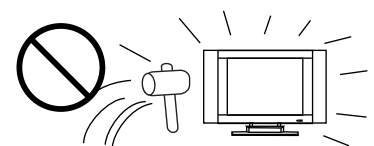

Don't try to push anything into the cabinet or place any vessel with water on the TV set.

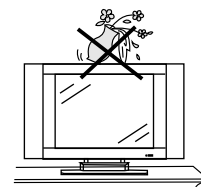

For added protection for this television equipment during a lightning storm, or when it is left unattended and unused for long periods of time, unplug it from the wall outlet and disconnect the antenna. This will prevent damage to the equipment due to lightning and power-line surges.

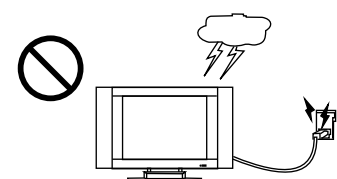

Important Safety Cautions

Important Information Regarding use of Video Games, Computer, captions or other fixed images displays

The extended use of a fixed image program material can cause permanent "Shadow Image" on the LCD panel. The background image is viewable on normal programs in the form of stationary fixed images. This type of irreversible LCD panel deterioration can be limited by observing the following steps:

- * Reduce the Brightness and Contrast settings to a minimum viewing level.
- * DO NOT display the fixed image for extended periods of time.
- * Turn the power OFF when not in actual use.

Recycling

This product utilises tin-lead solder, and has a fluorescent lamp containing a small amount of mercury. Disposal of these materials may be regulated in your community due to environmental considerations. For disposal or recycling information please contact your local authorities.

Identification of controls

Control buttons

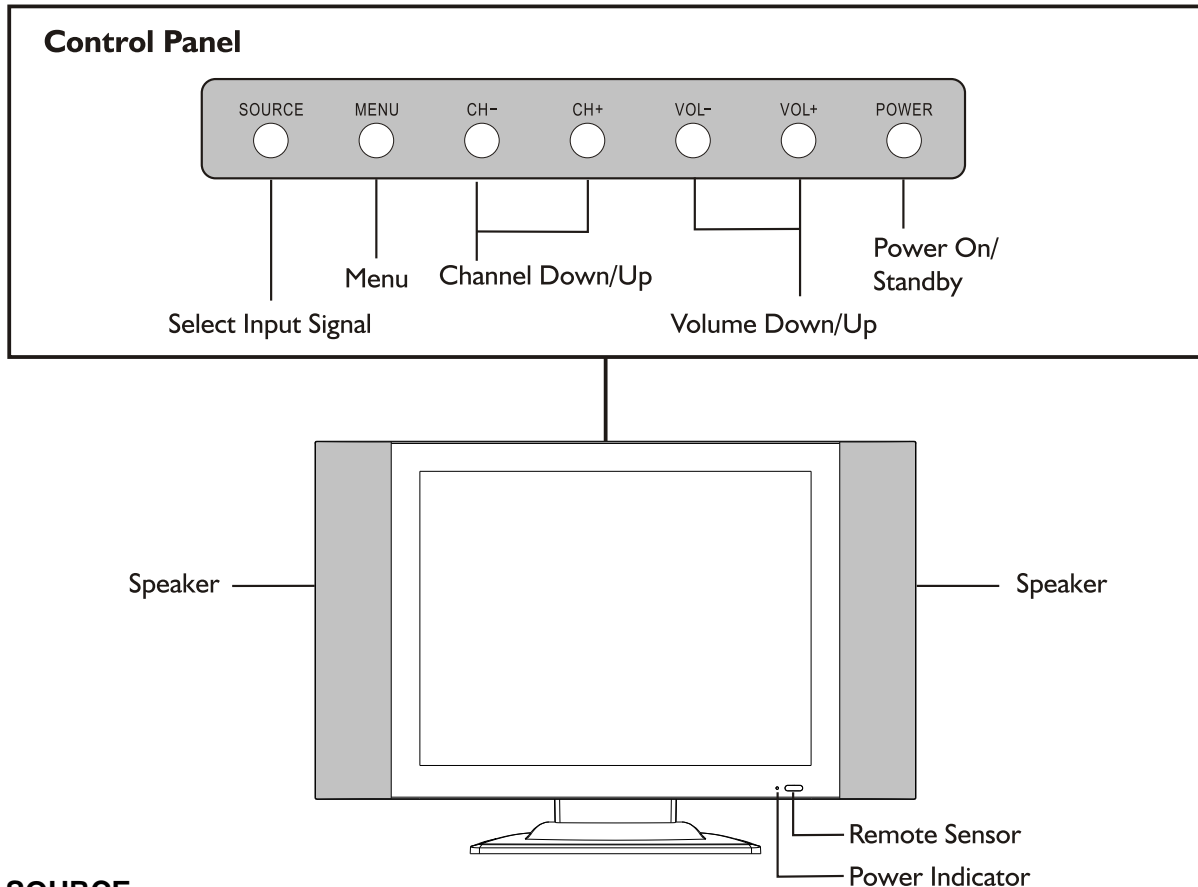

1. SOURCE

To access the SOURCE select menu

2. MENU

Press this button to access the MENU main page.

3. CH +/-

Change the TV channel.

In OSD Menu, press these buttons to choose the OSD items.

4. VOL +/-

Increase or decrease the sound volume level.

In OSD Menu, press these buttons to adjust the value or setting of each item.

5. POWER (⏻)

Press this button to turn the unit ON from STANDBY mode. Press it again to turn the set back to STANDBY.

Remote Sensor

Power Indicator

The Power Indicator light will glow yellow when the set is turned on, and glows red when the set is in the standby mode.

Note:

SOURCE, MENU, CH+/-, VOL+/- and POWER (⏻) on the main unit have the same functions as the corresponding buttons on the remote control.

This operation manual provides a description based on operating functions with the remote control.

Identification of controls (continued)

Back

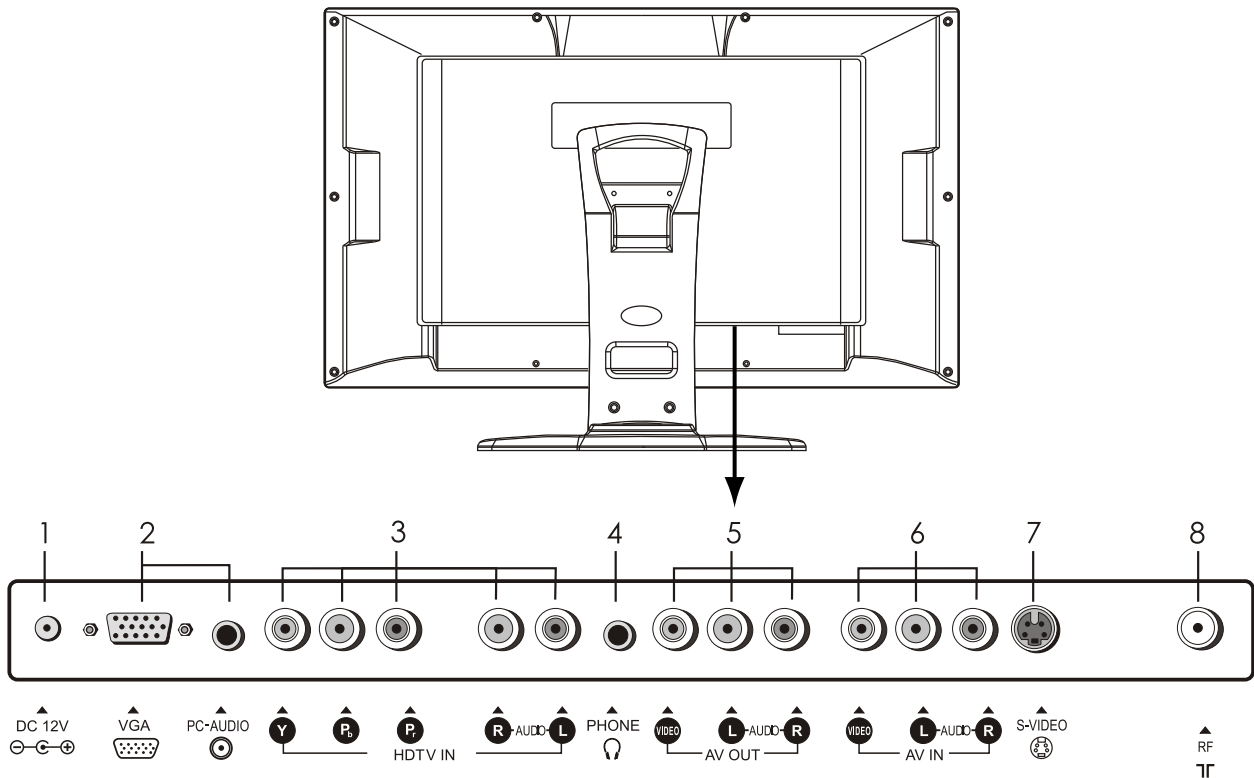

1. DC POWER input

Connect to the DC output of the Power Adapter

2. VGA input / PC- Audio in.

Connect to the VGA/audio output \varnothing 3.5mm jacks on your PC.

3. HDTV input (Y, Pb, Pr, Audio L, R)

Connect to the Y/Pb/Pr (or Y/Cb/Cr) and audio output jacks of a Set-Top Box or DVD player.

4. Headphone \varnothing 3.5mm jack

5. AV outputs (Video, Audio L, R)

Connect to the VCR input jacks to record programs.

6. AV inputs (Video, Audio L, R)

Receive video/audio signals from external sources such as VCR or DVD player.

7. S-Video input

Receive a S-Video signal from external source such as VCR or DVD player.

8. Coaxial cable & Antenna input

Remote Control

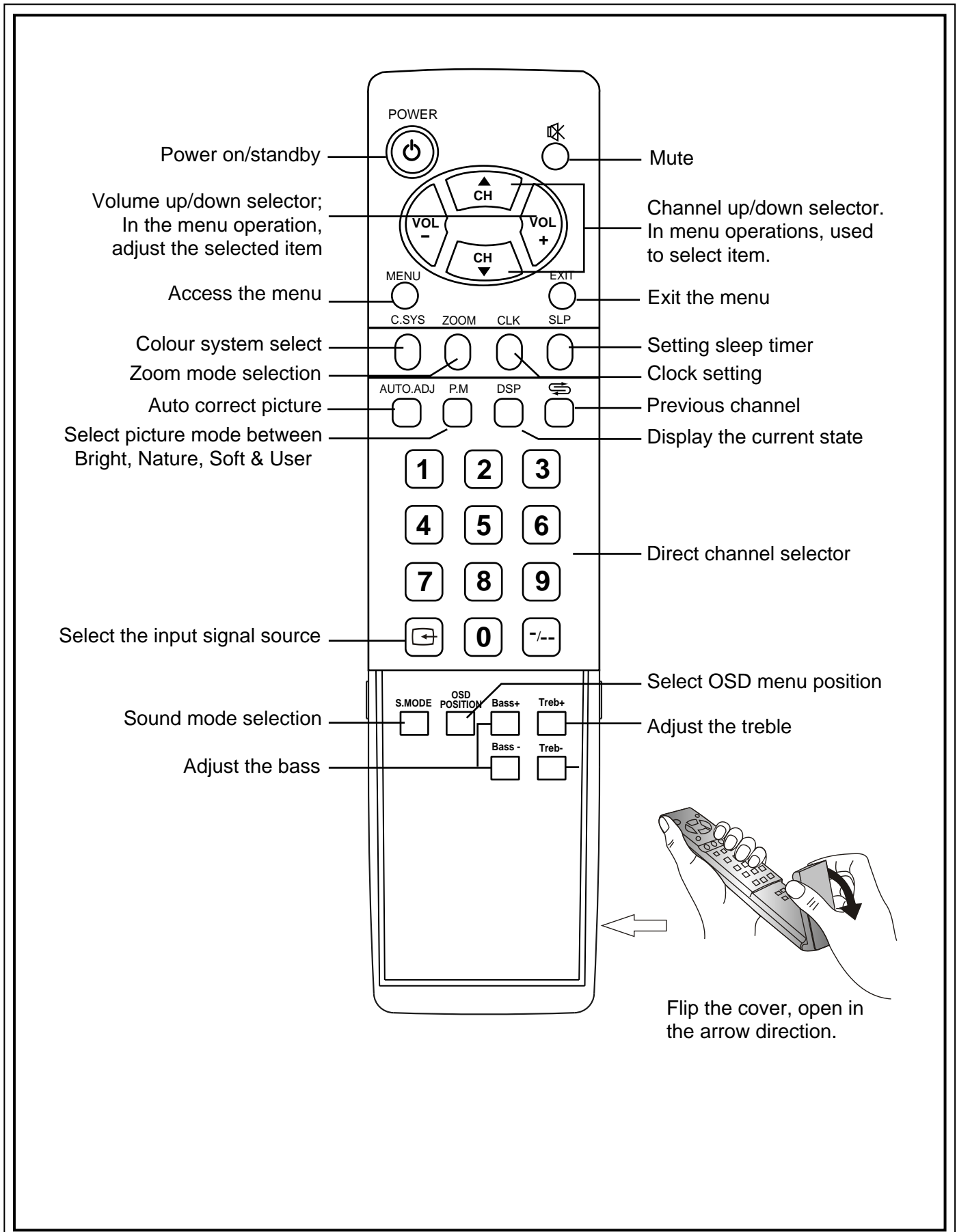

Preparing the Remote Control

Please install the batteries before using the remote control.

Batteries for the Remote Control

If the remote control fails to operate the LCD TV functions, replace the batteries in the remote control.

1 Open the battery cover.

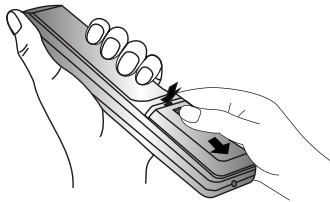

■ (Slide the cover while pressing down.)

2. Insert two size-AAA batteries

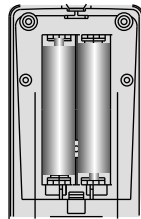

■ (Place the batteries with their terminals corresponding to the (+ and (-) indications in the battery) compartment.)

3 Replace the cover and slide in reverse until the lock snaps.

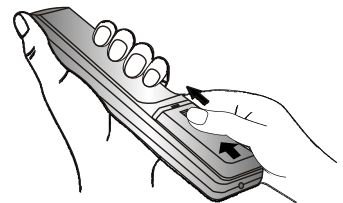

Effective range of the remote control

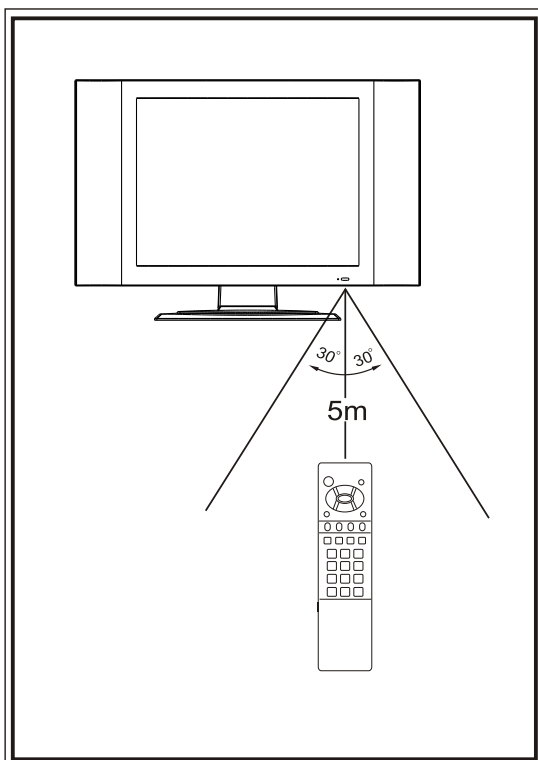

! Notes:

1. When the remote control will not be used for a long period of time or when the batteries are worn out, remove the batteries.
2. Do not drop or dampen the remote control.
3. Do not disassemble the remote control.
4. There should be no obstacle between the TV and the transmitter.
5. Use the remote control within the effective range as shown in the figure on the left.
6. If the remote control does not work, please check whether the batteries are exhausted or if they have been installed properly.
7. When direct sunlight, and incandescent lighting, fluorescent lamp or any other strong light shines on the remote sensor of the TV, the remote operation can be come erratic.
8. Do not mix different types of batteries in the remote.

Installation

Install the unit in a room where direct light will not fall upon the screen. Total darkness or a reflection on the picture screen may cause eyestrain. Soft and indirect lighting is recommended for comfortable viewing.

Antenna connection

Optimum reception of colour requires a good signal and will generally mean that an outdoor aerial must be used. The exact type and position of the aerial will depend upon your particular area.

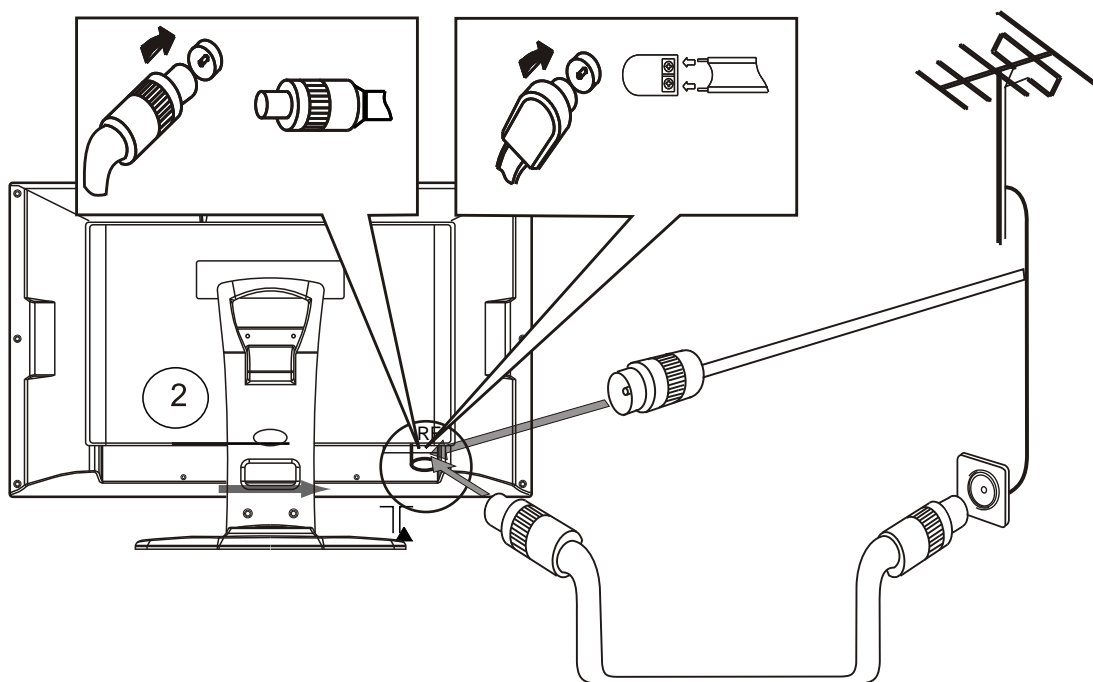

Note:

It is recommended that the 75-ohm coaxial cable be used to eliminate interference and noise which may occur due to radio wave conditions.

The aerial cable should not be bundled with the power cord and the like.

Installation (continued)

Power connection

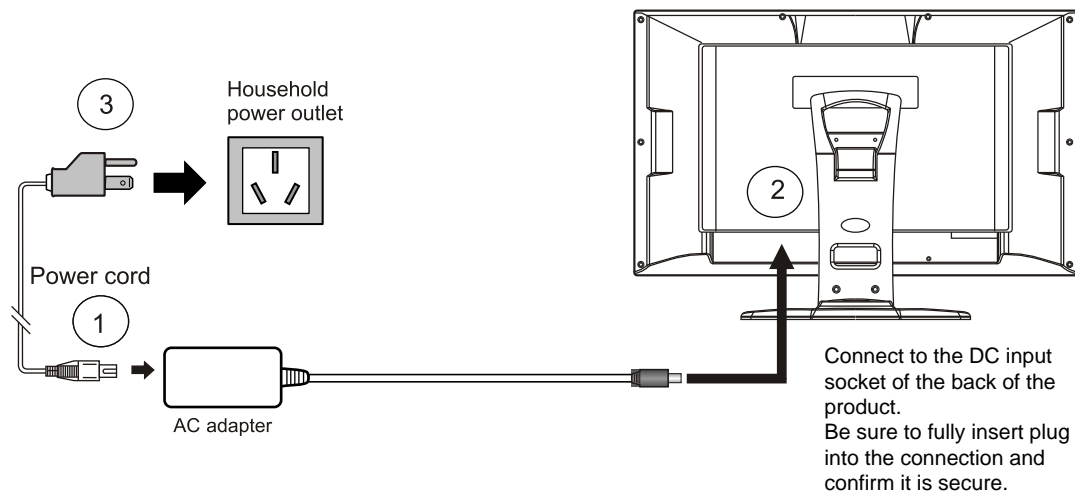

1. Connecting the female plug to the AC socket on AC adapter.
2. Connecting the AC adapter to the DC power input of the set.
3. Connecting the male plug to the wall outlet as illustrated.

Note:

Always turn off the Power to the LCD TV when connecting the AC adapter.

- *This product should only be operated with the type source marked on the label on the unit.*
- *Always unplug the AC adapter from the product and power outlet when the LCD TV is not in use for an extended period of time.*
- *The illustration of power cord and power outlet is only for your reference and may vary depending on your area.*

Installation (continued)

Elevation adjustment

You can adjust the angle of the LCD TV as follows
The elevation can be adjusted from -5° to $+10^{\circ}$ average.

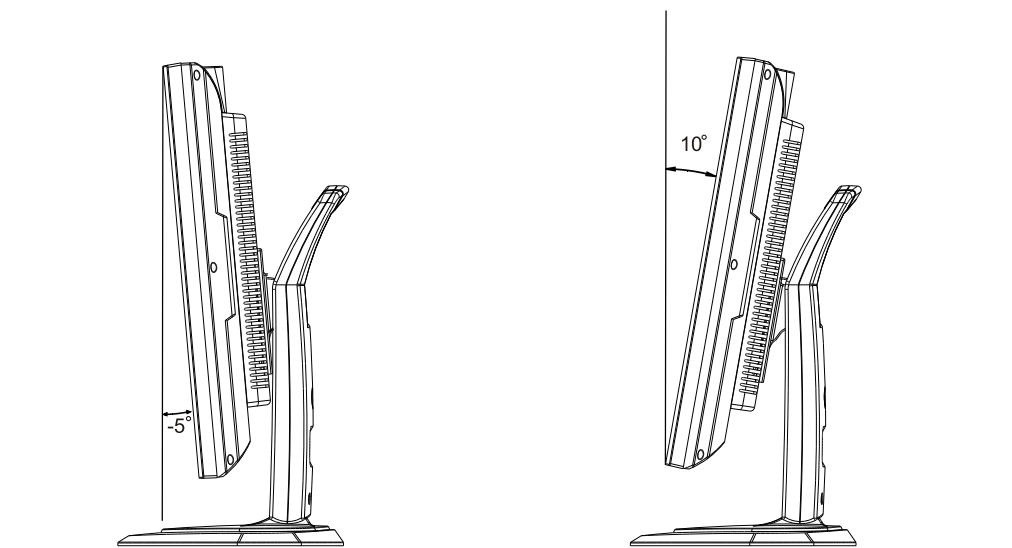

Installation (continued)

Notes about connection

1. Carefully check the terminals for position and type before making any connections.
2. Loose connectors will result in image or colour problems. Make sure that all connectors are securely inserted into their terminals.
3. When connecting an external device, turn off the power to the main unit first to prevent any possible damage.

Connecting the Video/Audio equipment

You can connect the unit to a DVD or VCR to enjoy playback with high quality picture and sound. Please refer to the instruction manual of the equipment to be connected.

Composite Video signal connection

Connect the composite video signal terminal on the TV to the output of AV equipment through composite cable. If you select the video signal, please set the input signal source of LCD TV to **AV** mode.

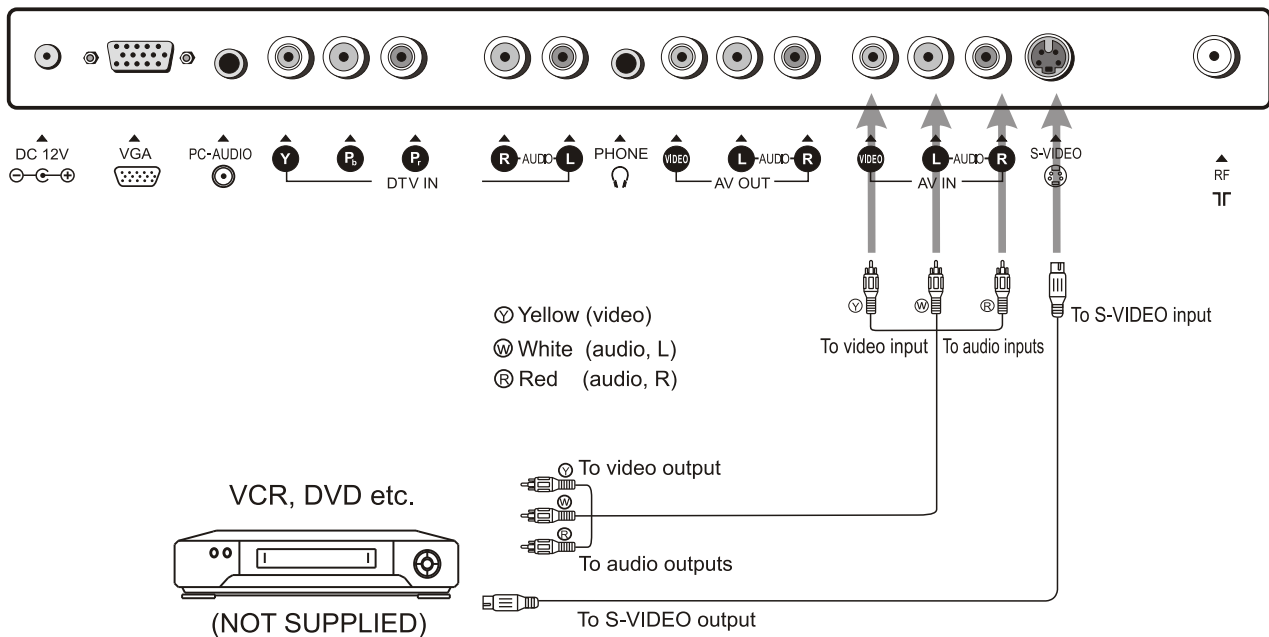

Note: Composite video is the most common used signal, but the picture quality is not as high as S-video.

S-VIDEO Signal Connection

Connect the S-video terminal on the TV to the output of AV equipment using a S-video cable. If you select S-video signal, please set the input signal source of LCD TV to **SVIDEO** mode.

Note:

S-Video is a signal format which transfers the colour and brightness of the picture with higher quality than a Composite connection. The S-Video signal connection is recommended to produce the best picture. Audio is shared between the AV and S-Video inputs.

Installation (continued)

The PC input signal connection

Connect the VGA (D-sub) input interface on the TV to the output of PC equipment through Min D-sub 15 pin cable as illustrated. For the audio connection, use an audio cord that matches the audio output terminal on the computer.

If you select PC signal, please set the input signal source of LCD TV to **RGB** mode.

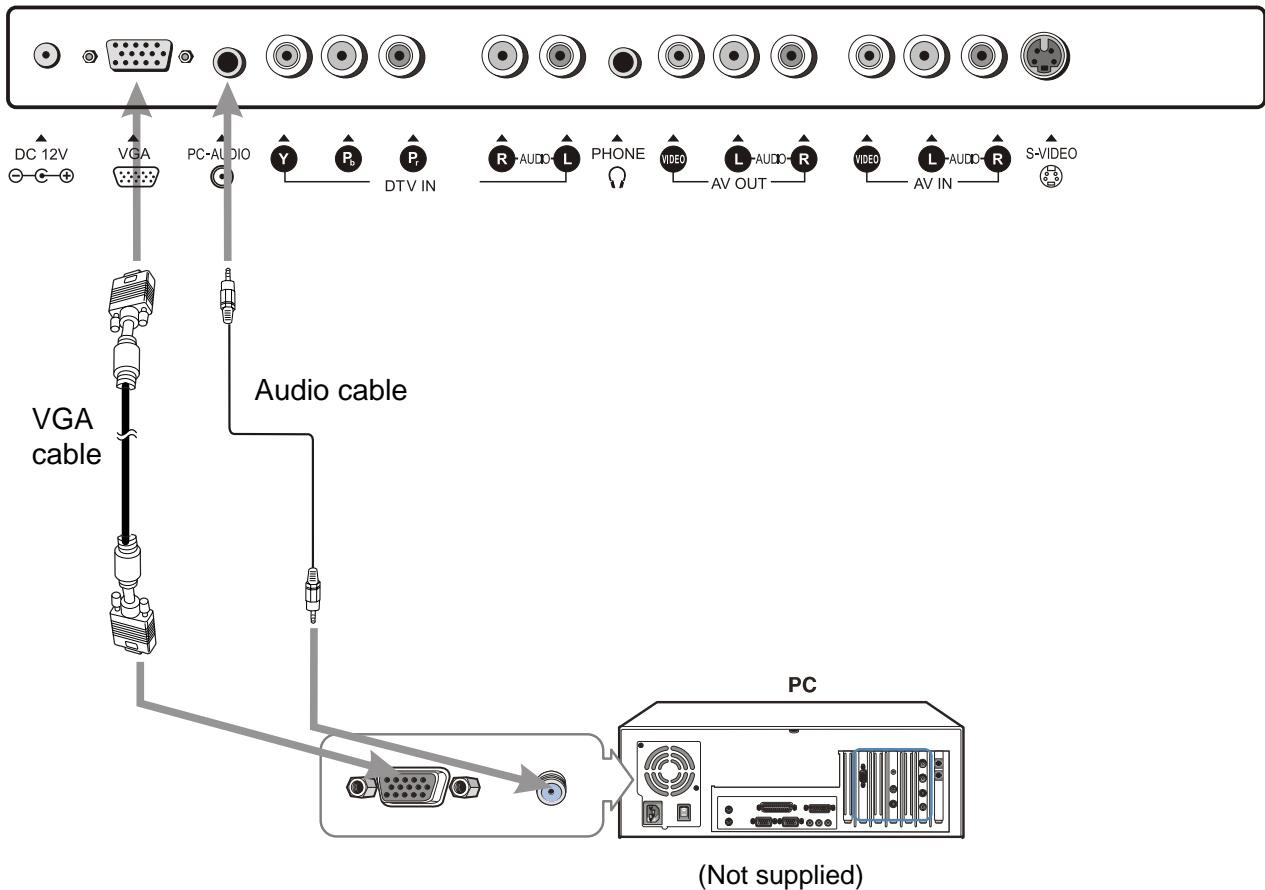

! Notes:

1. The native display resolution is 1280 x 1024. If the signal resolution exceeds this resolution, it may not be possible to show fine detail with sufficient clarity.
2. We strongly recommend that you set the refresh rate on the PC to 60Hz. If you set it above 60Hz, the unit may not display correctly. (Control Panel/Display Settings)
3. Use OSD to make final image adjustments.

Installation (continued)

AV OUT connection

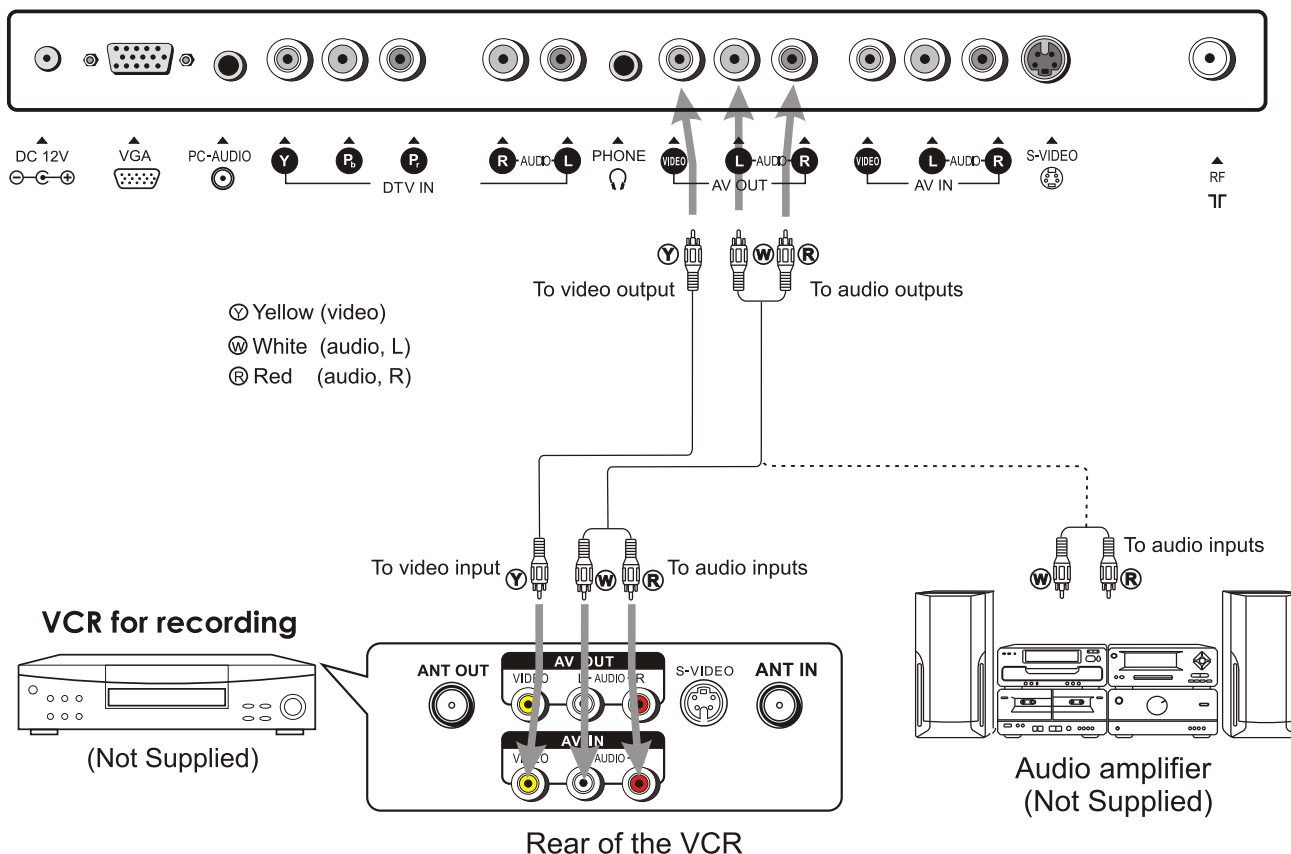

How to connect:

Connect the video/audio output terminals on the TV set to the signal input terminals of the VCR equipment or the video/audio input terminals on other TV set through a video/audio cable.
Connect the audio output terminals on the TV set to the Audio amplifier through audio cable.

How to record the TV program:

1. Connect cables as shown above.
2. Turn on the LCD TV and select source.
3. Turn on the VCR and insert the tape.
4. Select the video input from the VCR menu that corresponds to the AV in on the VCR.
5. Press the "RECORD" button to begin recording.

How to enjoy high quality sound by Audio amplifier:

1. Connect cables as shown above.
2. Turn the volume of the Audio amplifier to minimum.
3. Turn on the LCD TV and select source.
4. Turn on the audio amplifier and adjust for a proper volume.

Installation (continued)

YPbPr input connection

Please connect the YPbPr input terminals on the TV set for better picture quality. And connect the audio outputs with the corresponding audio input terminals on the TV set.

If you select YPbPr signal, please set the input signal source of the LCD TV to **YPbPr** mode.

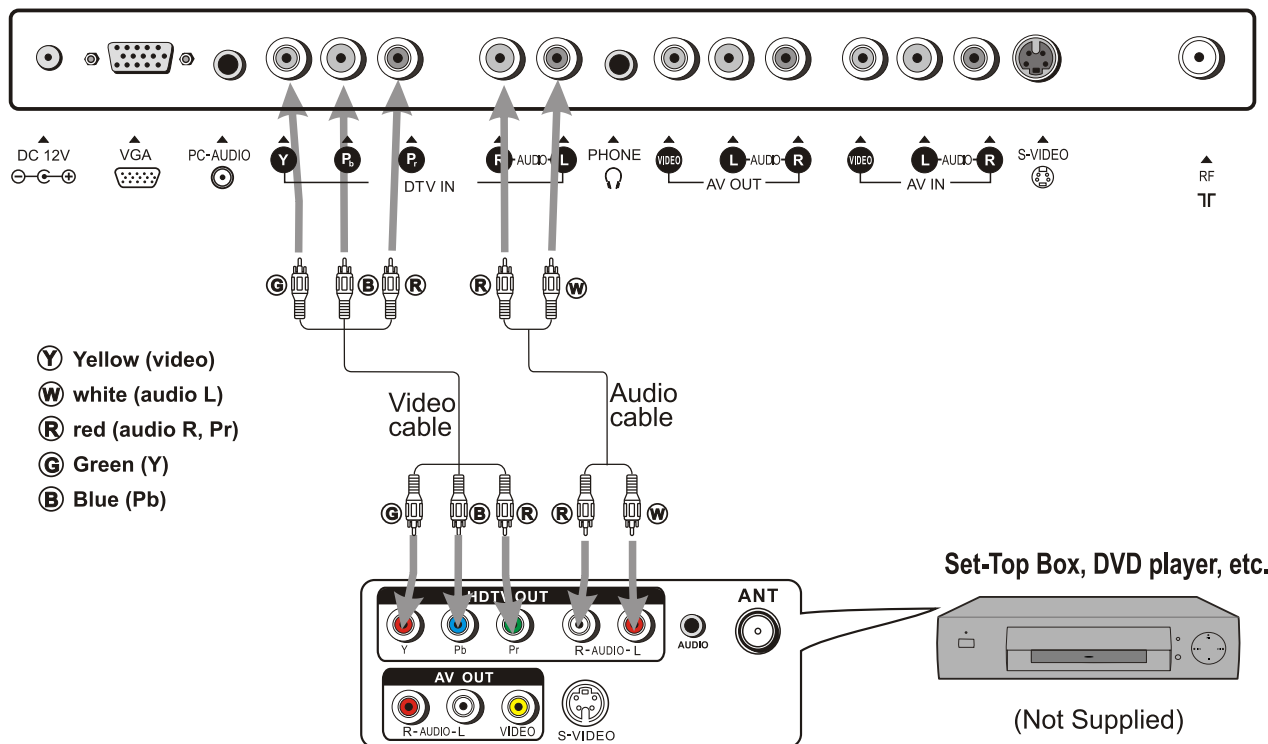

Notes:

The Y, Pb, Pr outputs on your DVD player are sometimes labelled Y, Cb, Cr. If so, connect the cables to like colours.

Basic Operations

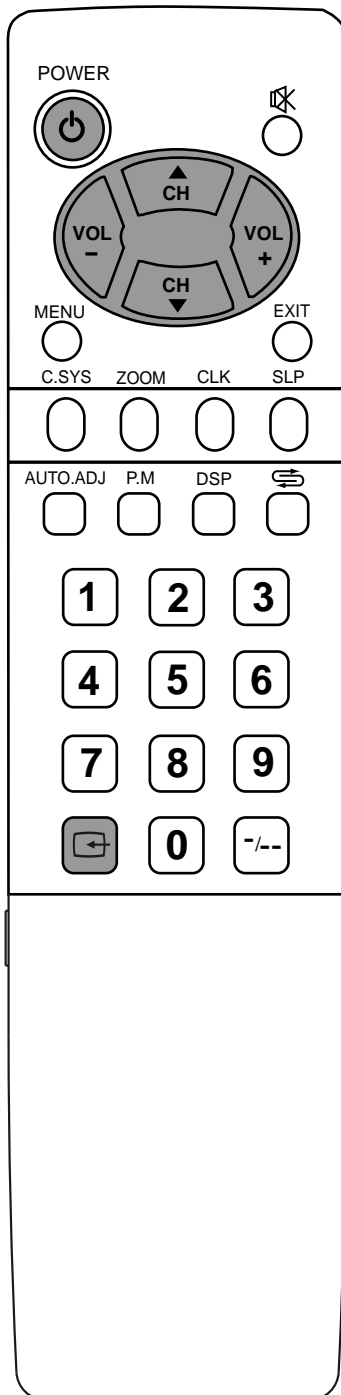

Turning on

- 1 Connect the power correctly, then the red indicator lights up and the unit is in STANDBY mode.
- 2 Press the **POWER** (⏻) button on the remote control or on the unit to turn on the TV set. The indicator will turn to yellow.

Turning off

- 1 With the power on, press the **POWER** (⏻) button to turn off the TV and the TV is in STANDBY mode, the indicator will turn to red.
- 2 If you want to turn off the power completely, unplug the power cord from the wall outlet.

⚠ **Note:** Do not switch the on/off state of the unit quickly. The interval of the turning on and turning off should be more than 5 seconds.

Selecting input signal

- 1 Press the **SOURCE** button on the unit or  button on the remote control. The screen displays the menu as shown on the right.
- 2 Press **CH** ▲/▼ to highlight your desired input signal source. Press **VOL** +/- or wait for about 4 seconds and the desired signal source will be selected.

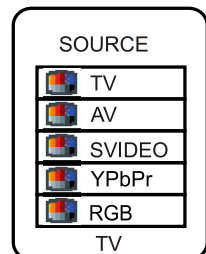

⚠ **Note:** All buttons shown in the manual are located on the remote control unless otherwise indicated.

Main On-Screen-Display (OSD) introduction

- 1 Press **MENU** button to display menu screen.
- 2 Press **VOL+/-** to select the menu.
- 3 Press **CH ▾** to access the menu.
- 4 Press **CH ▲ / ▾** to select the item.
- 5 Press **VOL+/-** to adjust the item.
- 6 Press **EXIT** button repeatedly to exit the menu.

TV/AV/S-VIDEO MODE

Picture Setting Menu

brightness		50
contrast		50
color		16
sharpness		32
tint		0

System Setting Menu

blue screen	on
backlight	6
scaler mode	fill all
color sys.	Auto
sound sys.	I
sleep time	10 minutes

Audio Setting Menu

SRS	on	off
bass		0
treble		0
balance		0
AVC	off	

Channel Setting Menu

channel number	9
skip	off on
manual search	
auto search	
fine tune	
channel edit	

OSD Setting Menu

language	English
OSD position	
OSD background	opaque translucent
OSD timeout	30 seconds

Signal Information Menu

video type: PAL / 50Hz
mode: 3

YPbPr / RGB MODE

Picture Setting Menu

brightness		50
contrast		60
color temp	5000K 7300K 9300K user	
customer temp setting		

System Position Menu

h position		50
v position		50
frequency		866
phase		15

Audio Setting Menu

SRS	on	off
bass		0
treble		0
balance		0
AVC	off	

System Setting Menu

sleep time	20 minutes
back light	6

OSD Setting Menu

language	English
OSD position	
OSD background	opaque translucent
OSD timeout	30 seconds

Signal Information Menu

resolution: 640 x 480/60Hz
mode: 40

Note: in **AV/S-VIDEO** mode, **Channel Setting** menu can not be accessed and in **System Setting** menu some menu items (such as **color sys.** and **sound sys.** menu item) is grey and can not be adjusted.

Operations

Channel Setting

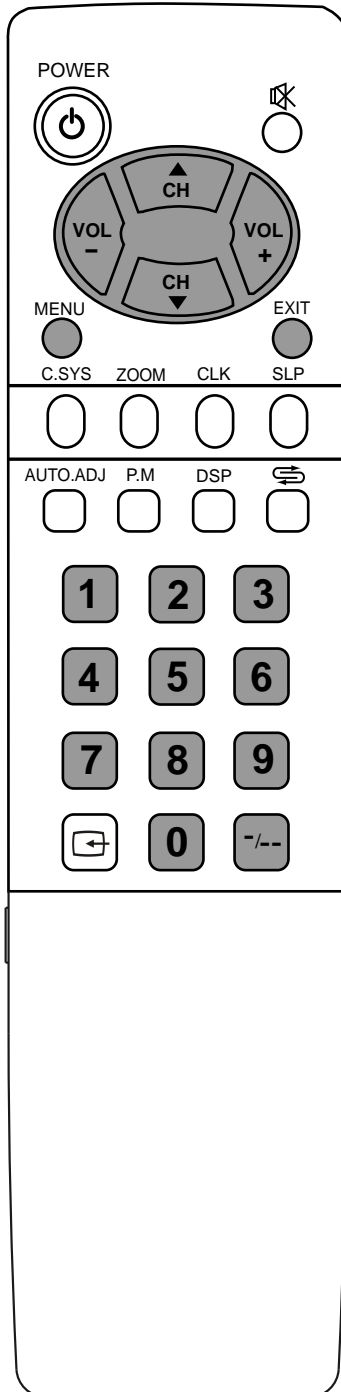

There are two ways to preset channels: to preset channels automatically and to preset channels manually. Below we will describe how to preset the channels by making use of the menu.

Auto Search

- 1 Access **Channel Setting** menu.
- 2 Press **CH** \uparrow/\downarrow button repeatedly to highlight **auto search** item.
- 3 Press **VOL+/-** to start Auto Search.
All active channels will be preset and stored into the memory automatically.

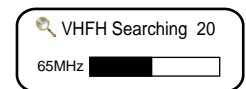
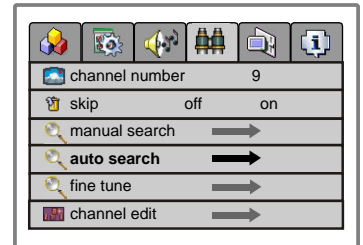

During the process of **Auto Search**, pressing **MENU** will stop the process.

Manual Search

If Auto Search can not preset the desired channels, or you want to preset the desired channels one by one with the preferred channel numbers, please make use of Manual Search.

- 1 Use channel select buttons to select a channel number.
- 2 Access **Channel Setting** menu.
- 3 Press **CH** \uparrow/\downarrow button repeatedly to highlight **manual search** item and press **VOL+** to enter.
- 4 Press **VOL+** or **VOL-** button to perform the searching.

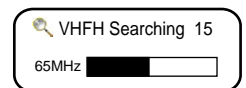
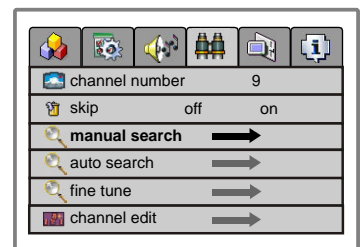

When a channel is located, the searching stops, this channel is then memorised with the preset channel number.

Operations

Channel Setting

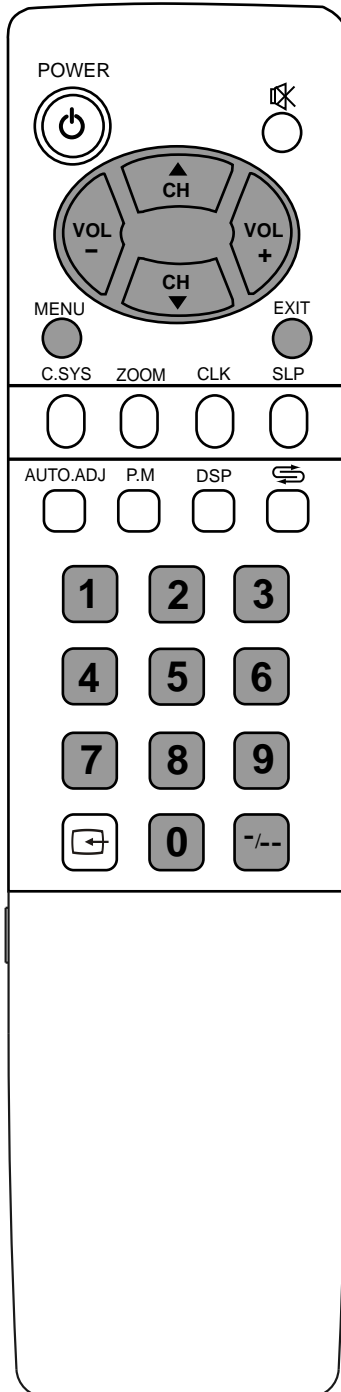

To skip unnecessary channel

After presetting the channels, you can skip unnecessary channels so that only the channels you want to watch are selected when you press the **CH ▲/▼** to change channels.

- 1 Select the channel number which you want to skip using the keypad.
- 2 Access the **Channel Setting** menu.
- 3 Press **CH ▲/▼** to select **skip** item.
- 4 Press **VOL+/-** to select **on**.

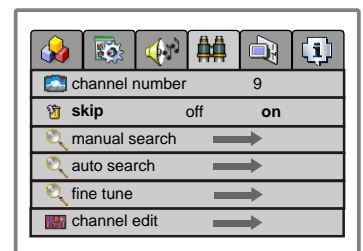

Now when you press **CH ▲/▼** to change channels, this channel will be skipped.

If you want to resume a skipped channel, use the keypad buttons to enter the channel, then access the **Channel Setting** menu and select **skip**, press **VOL+/-** to set **skip off**. When you press **CH ▲/▼** to change channels, the channel will be present.

Fine tuning

Fine tuning is not necessary under normal conditions. However, in area of inferior broadcast conditions where adjustment is necessary for a better picture and sound, use Fine tuning.

- 1 Access the **Channel Setting** menu.
- 2 Press **CH ▲/▼** button repeatedly to highlight **fine tune** item.
- 3 Press **VOL+/-** to fine tune to achieve best picture and sound.

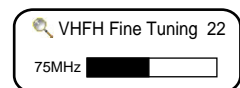
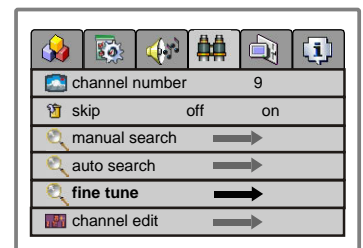

Operations

Channel Setting

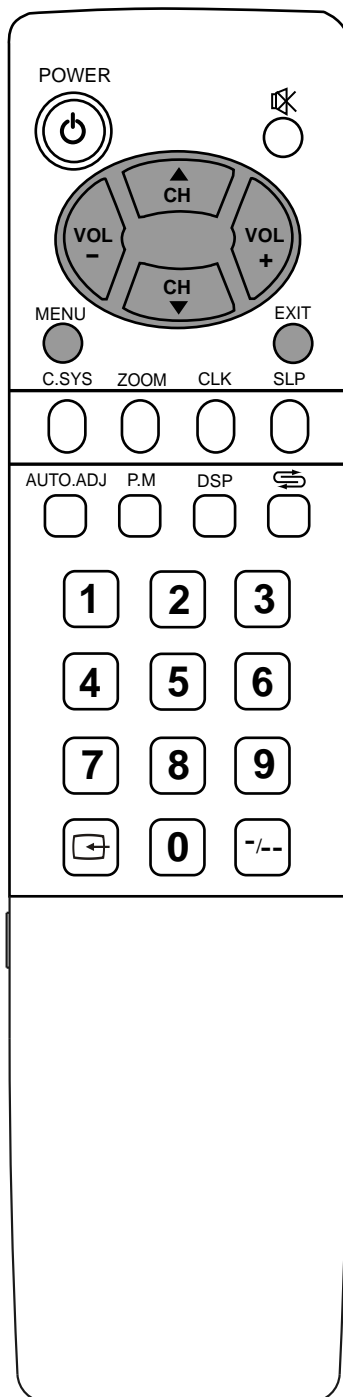

Channel edit

You can edit the channel programs in your favourite order.

1 Access the **Channel Setting** menu.

2 Press **CH ▲/▼** to select **channel edit**. Press **VOL+/-** to enter into the sub-menu.

3 Press **CH ▲/▼** to select **current channel**, press **VOL+/-** to select a current channel number.

4 Press **CH ▼** to select **exchange to**, press **VOL+/-** to select a target channel number.

5 Press **CH ▼** to select **exchange channel**, press **VOL+/-** then these two channels' contents are exchanged.

Repeat the above steps to edit the programs in your favourite order.

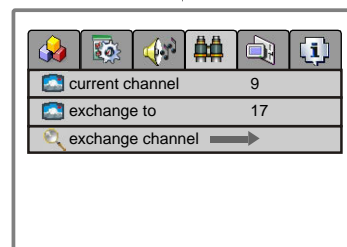
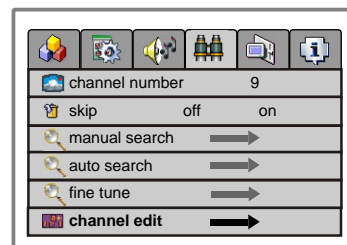

Operations

Selecting channel

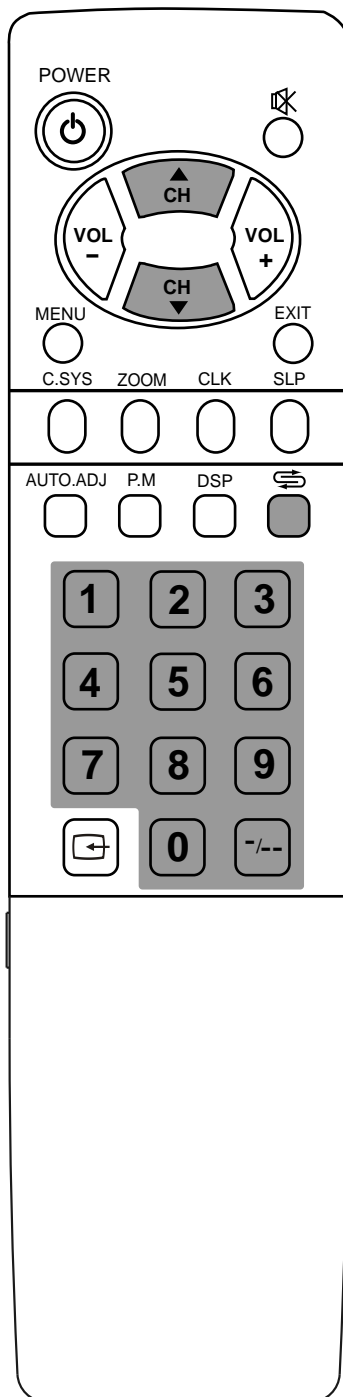

* You can press **DSP** button to know current channel number information.

Using Keypad buttons

1 To select one-digit channel numbers:

Input the channel using the **0-9 number button**, then wait for about 2 seconds.

2 To select two-digit channel numbers:

Press **-/--** button to display --, then input the channel using the **0-9 number button**.

3 To select three-digit channel numbers:

Press **-/--** button to display ---, then input the channel using the **0-9 number button**.

Note: The period between presses should be within 2 seconds.

Using Channel up/down buttons

- 1 Press **CH ▲** button, the channel number increases;
- 2 Press **CH ▼** button, the channel number decreases.

Using previous channel button

Press **↔** button to switch between the current channel and previous channel.

Operations

Picture adjustment

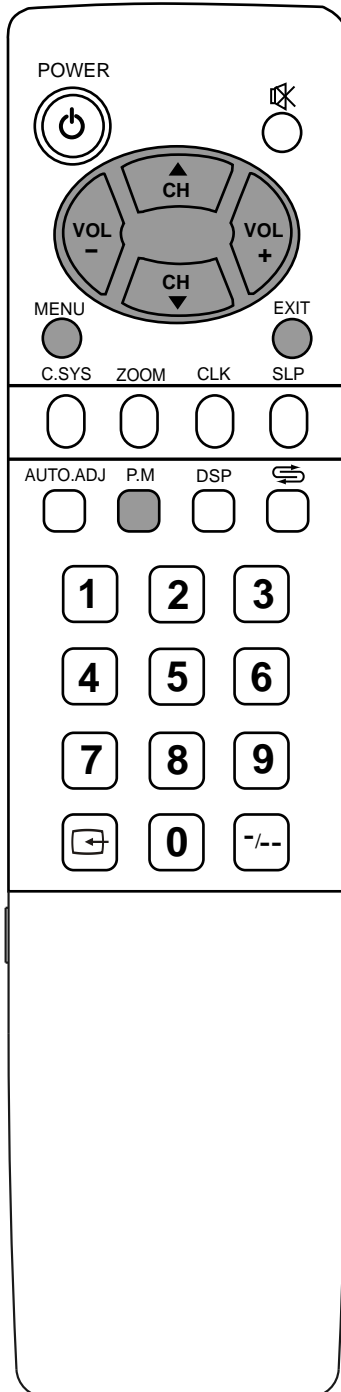

1 Access **Picture Setting** menu by pressing **MENU** button.

2 Press **CH**▲/▼ to select the item that you want to adjust.

3 Press **VOL**+/- to adjust selected item.

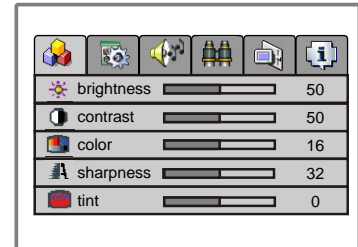

Item	Function	Range
brightness	To adjust picture's brightness	0-100
contrast	To adjust picture's contrast	0-100
color	To adjust picture's colour	0-32
sharpness	To adjust pictures sharpness	0-63
Tint*	To adjust picture's tint	-32-+31

Note: Tint is only for NTSC system.

You can select picture mode by **P.M** button. There are four picture modes: **Bright**, **Nature**, **Soft** and **User**.

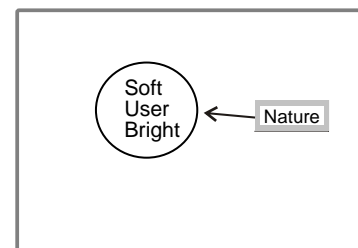

Bright: Select for a bright picture.

Nature: Select for a standard picture.

Soft: Select for a soft picture.

NOTE: Setting the unit to a Bright Picture with high brightness and contrast levels will cause picture quality loss.

Operations

Audio Setting

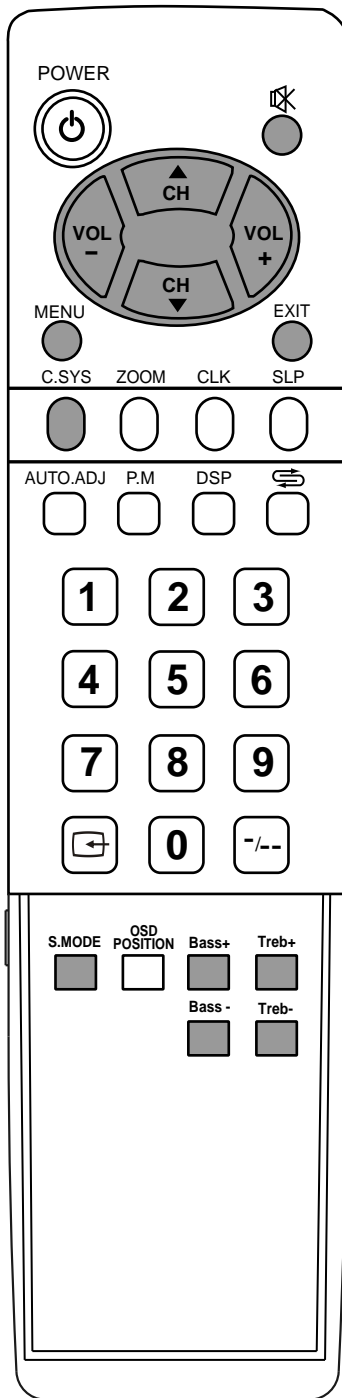

You can directly press **Bass+/-** **Treb+/-** button on the remote control to adjust bass and treble.



The SRS symbol are trademark of SRS Labs, Inc. SRS technology is incorporated under license from SRS Labs, Inc.

Adjusting volume

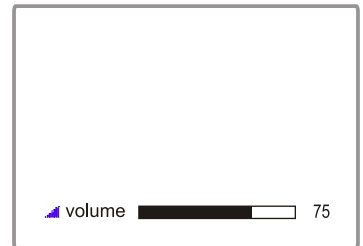

Press **VOL+/-** to adjust volume. Press **VOL+** button, the volume increases. Press **VOL-** button, the volume decreases. (Range: 0-100)



Muting the sound

You can press the  button on the remote control to mute the sound. Press the  button again to restore. You can also press **VOL+** to restore the sound.

Making use of the Audio Setting Menu

- 1 Access **Audio Setting** menu.
- 2 Press **CH**  /  to select the item that you want to adjust.
- 3 Press **VOL+/-** to adjust selected item.

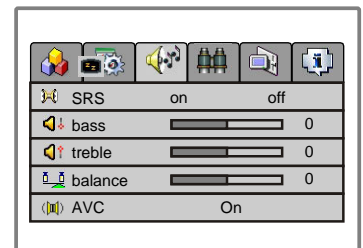

Item	Function	Range
SRS	SRS (Sound Retrieval System®) is an audio enhancement technology that restores the spatial cues that are present in a live listening environment and processes it to provide a natural 3D sound field.	On/Off
Bass	Adjusts low sounds	-10 - +10
Treble	Adjusts high sounds	-10 - +10
Balance	Adjusts left and right volumes	-10 - +10
AVC	Auto volume control	On/Off

Tips about AVC:

Each broadcasting station has its own signal conditions, which can make it necessary to adjust the volume every time the channel is changed. **Turning "AVC" On lets you automatically adjust the volume of the desired channel** by lowering the sound output when the modulation signal is high or by raising the sound output when the modulation signal is low.

Selecting the sound mode

You can press **S.M** button on the remote control to switch the sound mode between **user**, **movie**, **music**, and **news**.

Movie: Select for a movie program.

Music: Select for a music program.

News: Select for a speech or talk program.

Custom settings mode in the Audio Setting OSD are saved under **USER** mode.

Operations

System Setting

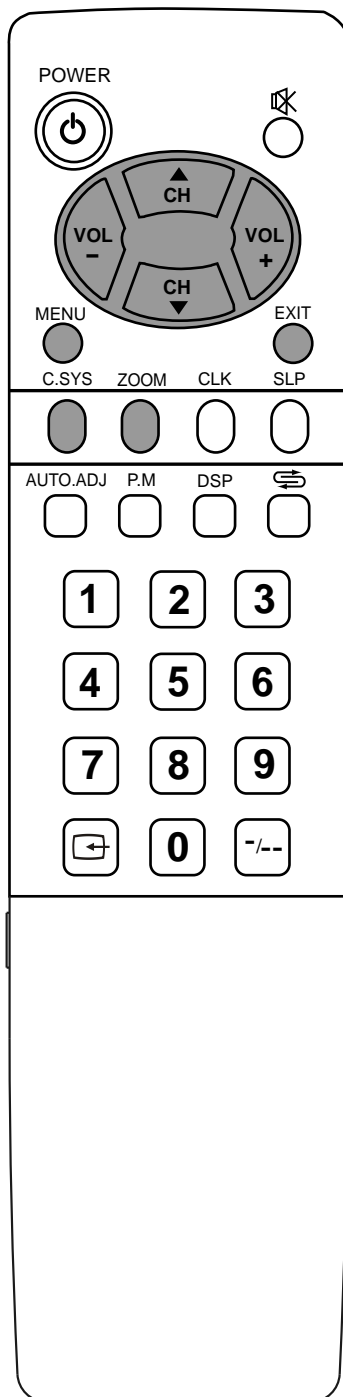

- 1 Access the **System Setting** menu.
- 2 Press **CH** ▲/▼ to select the item that you want to adjust.
- 3 Press **VOL** +/- to adjust selected item.

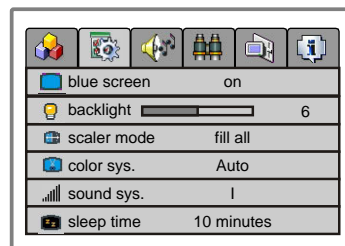

Item	Function	Choice/Range
Blue Screen	If you select on, the screen will display blue background when there is no signal (in TV, AV, SVIDEO mode).	On ↔ Off
Backlight	Adjusts the backlight brightness.	0 - 10
Scaler Mode	Setting screen display size.	Fill All ↔ Wide
Color Sys.	Selects colour system.	The choice is different depending on your area. Normally please select AUTO.
Sound Sys.	Selects sound system	The choice is different depending on your area. You can repeatedly press VOL+/- to select until the sound is normal.
Sleep Time	Setting sleep timer. When the presetting time is elapsed, the set will auto turn off and be in standby mode.	0,10,20,30,60,90,120,180,240

Note:

Only when the Blue Screen is On, the set will turn off automatically after 15 minutes if there is no input signal (in TV or AV mode).

You can directly press **C.SYS** button on the remote control to select color system. Normally please set the color system to AUTO.

You can directly press **ZOOM** button on the remote control to set screen display size.

Operations

OSD Setting

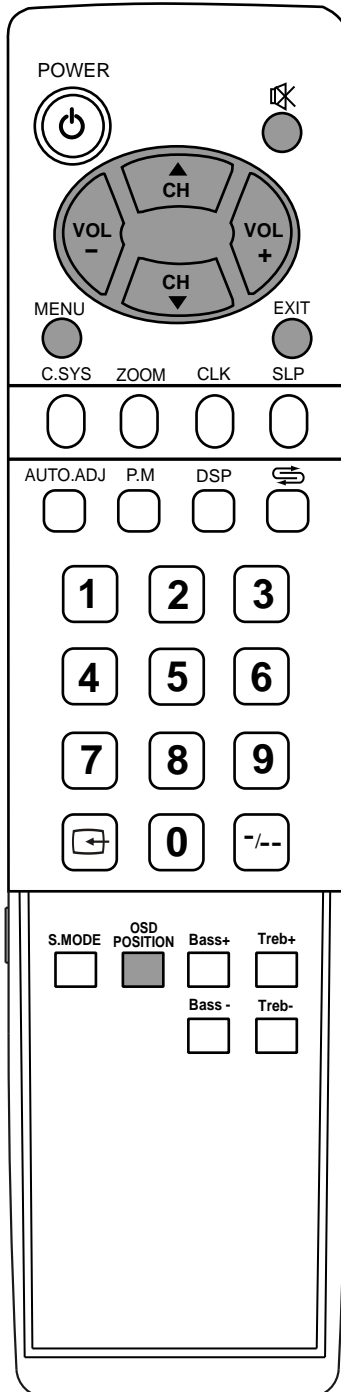

Setting the language of the menu

- 1 Access the **OSD Setting** menu.
- 2 Press **CH** \uparrow / \downarrow to select the **language** item.
- 3 Press **VOL** \pm to select an OSD language. If select English, then the OSD is displayed in English.

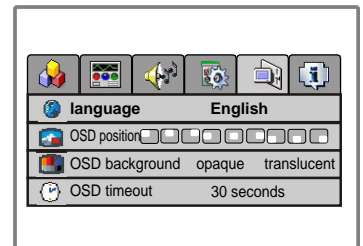

Setting the position of the menu

- 1 Access the **OSD Setting** menu.
- 2 Press **CH** \uparrow / \downarrow to select the **OSD position** item.
- 3 Press **VOL** \pm to select the position of the menu displaying.

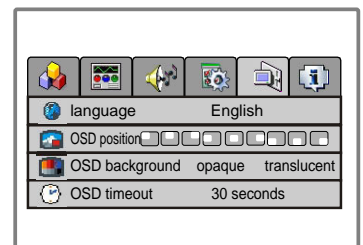

You can also press the **OSD POSITION** button on the remote control to select OSD menu position.

Setting background of the menu

- 1 Access the **OSD Setting** menu.
- 2 Press **CH** \uparrow / \downarrow to select the **OSD background** item.
- 3 Press **VOL** \pm to select **opaque** or **translucent**. If you select Opaque, the background of the menu is opaque. If you select translucent, the background of the menu is translucent.

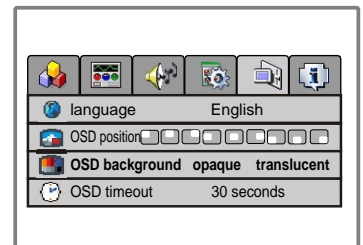

Setting OSD timeout

- 1 Access the **OSD Setting** menu.
- 2 Press **CH** \uparrow / \downarrow to select the **OSD timeout** item.
- 3 Press **VOL** \pm to set the timeout: 5, 10, 15, 20, 25, 30, 35, 40, 45, 50, 55, 60 seconds.

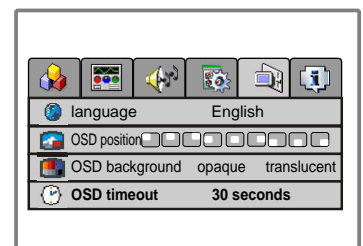

Operations

Timer Setting

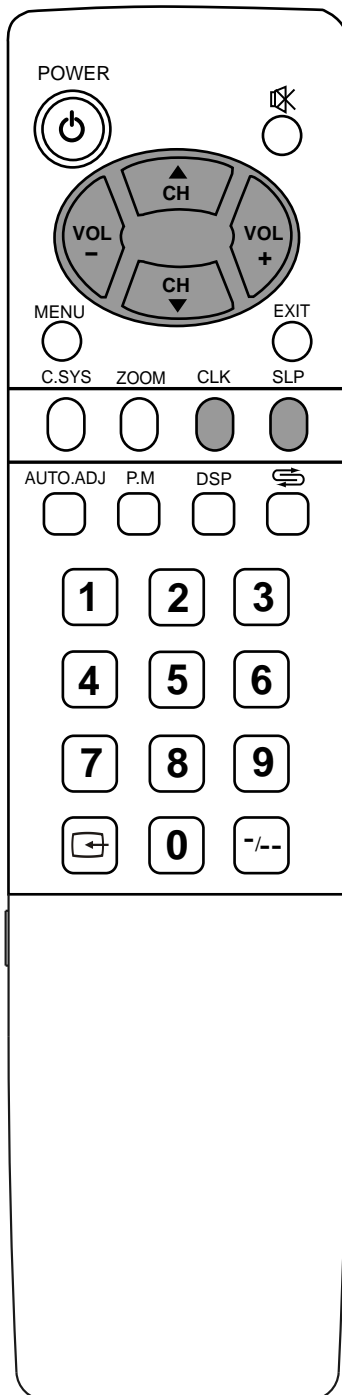

Using Sleep button

Press **SLP** button to display sleep time menu bar. Press **CH** \uparrow / \downarrow or **VOL** \pm repeatedly to set sleep time between: 0, 10, 20, 30, 60, 90, 120, 180, 240 minutes. If you select 0 minute, the sleep timer function is turned off.

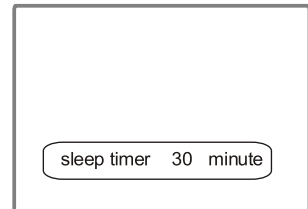

Press the **SLP** button again to exit the menu.

Using Clock button

1 Press **CLK** button, the **current time** menu bar appears. Press **VOL** \pm to select hour or minute. Use **CH** \uparrow / \downarrow to set time.

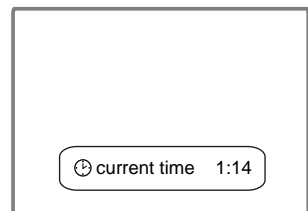

2 After setting **current time**, press **CLK** button again to display **turn on** menu bar.

Press **VOL** \pm to select hour, minute or status. Press **CH** \uparrow / \downarrow to adjust **turn on** time and **turn on** status (off, everyday, today)

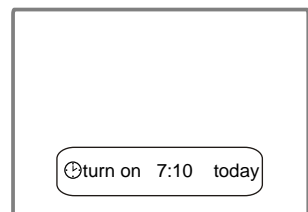

today: means the **turn on** setting effects today.

everyday: means the **turn on** setting effects everyday.

3 Press **CLK** once more to display **turn off** menu bar.

Press **VOL** \pm to select hour, minute or status. Press **CH** \uparrow / \downarrow to adjust **turn off** time and **turn off** status (off, everyday, today).

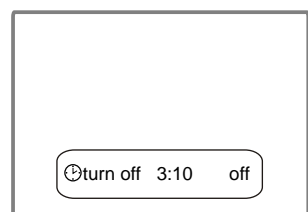

today: means the turn off setting effects today.

everyday: means the turn off setting effects everyday.

Operations in RGB/YPbPr mode

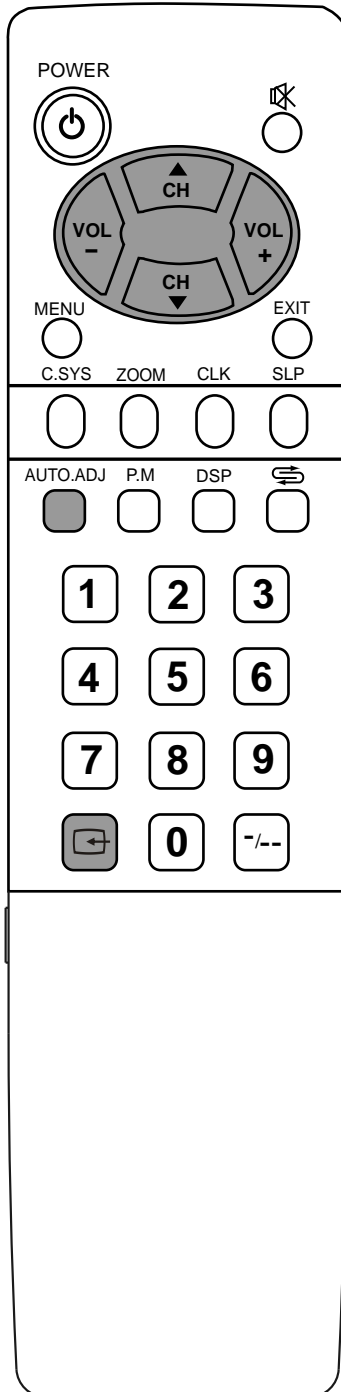

Select RGB/YPbPr mode

- 1 Press the **SOURCE** button on the unit or button  on the remote control. The screen displays the menu shown as right.
- 2 Press **CH** \uparrow / \downarrow to highlight the **RGB** or **YPbPr** item. Press **VOL** \pm or wait about 4 seconds and the signal source is selected.

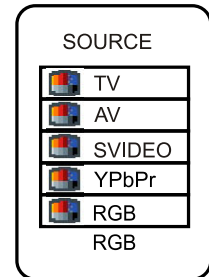

PC signal format

Connect VGA input and be sure that there is VGA input signal. The signal format should be set to: 1280 x 1024@60Hz.

! Note:

The resolution of the LCD panel is 1280 x 1024; any higher Resolution output from your PC Video card might distort the image.

Auto adjusting

When VGA signal format is changed or when you switch to RGB mode from another source, the unit adjusts frequency and phase automatically to obtain the best display. During the process of auto correction, the screen displays **Analog RGB Acquiring Signal**, and all buttons on the set and on the remote control do not work until this process is finished.

When the set displays some nonstandard VGA signals and can not adjust the picture to the best status by itself, you can adjust it again by pressing the **AUTO. ADJ** button on the remote control.

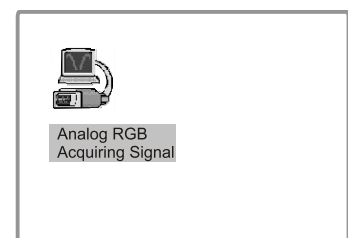

NOTE: Please note your final phase and frequency settings as you might need to re-adjust your screen.

Operations in RGB/YPbPr mode (continued)

Picture Settings

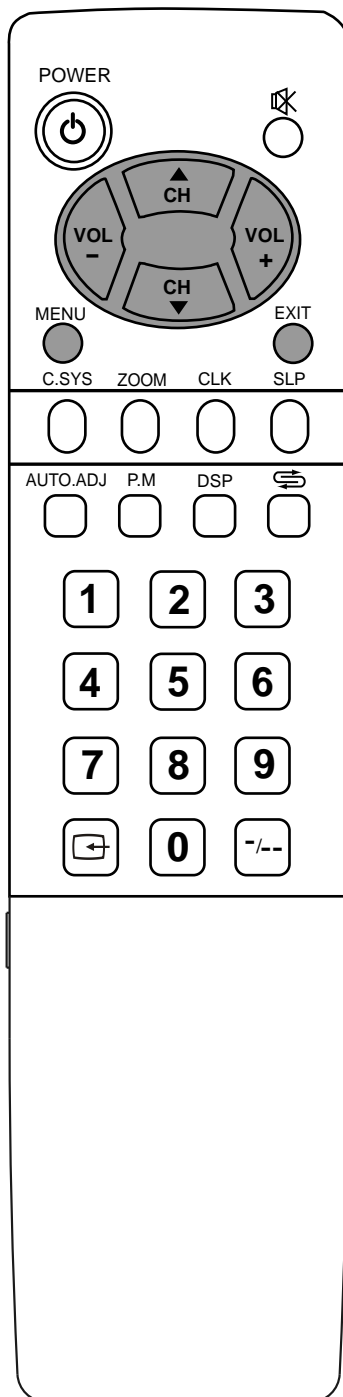

Adjusting Brightness/Contrast

- 1 Access the **Picture Setting** menu.
- 2 Press **CH▲/▼** to select brightness or contrast item.
- 3 Press **VOL+/-** to adjust the selected item.

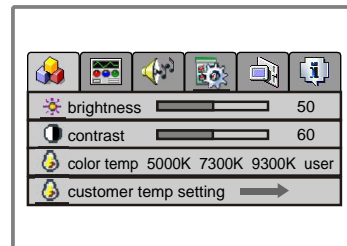

Item	Function	Notes
brightness	Adjust the brightness of the picture.	Adjusting the picture under RGB mode
contrast	Adjust the contrast of the picture.	Will Not affect the display settings in the TV, AV mode

Setting the color temperature

- 1 Access the **Picture Setting** menu.
- 2 Press **CH▲/▼** to select **color temp** item.
- 3 Press **VOL+/-** to switch the color temperature between 5000K, 7300K, 9300K and User.
- 4 If you want to change the value of the user mode, set **color temp** to user first, then select **customer temp setting** item, and press **VOL+/-** to access the sub-menu.
- 5 Press **CH▲/▼** to select the item and press **VOL+/-** to adjust it. The value you set will be stored .

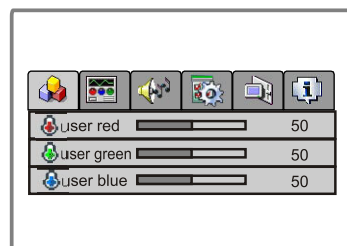
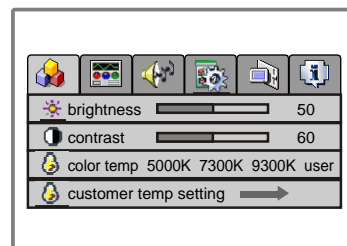

Troubleshooting

Before calling for service personnel, please check the following chart for a possible cause to the trouble you are experiencing.

Symptoms	Check item
Ghost or double images	<ul style="list-style-type: none"> • This may be caused by obstruction to the antenna due to high rise buildings or hills. Using a highly directional antenna may improve the picture.
No power	<ul style="list-style-type: none"> • Check that the AC power cord is plugged into the mains socket. • Unplug the power cord, wait for 60 seconds. Then reinsert plug into the mains socket and turn on the unit again.
No picture	<ul style="list-style-type: none"> • Check antenna connections at the rear of the unit to see if it is properly connected to the unit. • Possible broadcast station trouble. Try another channel. • Adjust the contrast and brightness settings. • Select a correct input. • Is a non-compatible signal being input?
Good picture but no sound	<ul style="list-style-type: none"> • Increase the VOLUME. • Check that the unit is not muted. • Check Whether the sound is output to headphone.
Good sound but poor colour	<ul style="list-style-type: none"> • Adjust the contrast, colour and brightness settings.
Poor picture	<ul style="list-style-type: none"> • Sometimes, poor picture quality occurs when having activated an S-VHS camera or camcorder connected and having connected another peripheral at the same time. In this case, switch off one of the other peripherals. • Check whether the room is too bright.
Horizontal dotted line	<ul style="list-style-type: none"> • This may be caused by electrical interference (e.g. hair dryer, nearby neon lights, etc.) • Turn off the equipment.
Television not responding to remote control	<ul style="list-style-type: none"> • Check whether the batteries are working. Replace if necessary. • Clean the remote control sensor lens on the unit. • Do not use the remote control under strong or fluorescent lighting. • The batteries should be inserted with polarity (+, -) aligned.
Snowy picture and noise	<ul style="list-style-type: none"> • Check the antenna connection.
No stable or not synchronised VGA picture	<ul style="list-style-type: none"> • Check if you have selected the correct VGA mode in your PC.
No output from one of the speakers	<ul style="list-style-type: none"> • Adjust Sound Balance.
Control buttons do not work	<ul style="list-style-type: none"> • Unplug the power cord, wait for some seconds. Then re-plug the power cord and turn on the unit again.

Note:

*If your problem is not solved, restart your TV by turning it off and then on again once.
Never attempt to repair a defective TV yourself.*

Specification

Power Supply for AC adaptor:	~ 100-240V 50/60Hz
Power Consumption:	60W
Resolution:	1280 x 1024
Pixel Pitch:	0.264mm x 0.264mm
Brightness:	400 nit
Contrast:	450:1
Viewing angle:	140°/140°
Dimensions (mm):	555(W) x 186(D) x 396(H) (with stand)
Weight (kg):	6.2
Screen:	43cm

TV system & channel coverage.

SYSTEM	VHF	UHF	CATV
PAL-B/G	2-12	21-69	X~Z+2, S1~S41
Colour system:	PAL-BG, NTSC (AV)		
Sound output:	3W, 8Ω		
Accessories	Operating manual x 1, Power cord x1 Remote control x 1, AC Adaptor x 1, AV cable x 1 (option), Audio cable x 1 (option).		

ⓘ Note: Design and specifications are subject to change without notice.

PALSONIC CORPORATION PTY LTD
1 JOYNTON AVENUE
WATERLOO NSW 2017 AUSTRALIA
TEL: (02) 9313 7111
FAX: (02) 9313 7555
www.palsonic.com.au

**PALSONIC CUSTOMER SERVICE
TELEPHONE
AUSTRALIA: 1300 657 888**

604-L17H33-00
Ver1.0

Free Manuals Download Website

<http://myh66.com>

<http://usermanuals.us>

<http://www.somanuals.com>

<http://www.4manuals.cc>

<http://www.manual-lib.com>

<http://www.404manual.com>

<http://www.luxmanual.com>

<http://aubethermostatmanual.com>

Golf course search by state

<http://golfingnear.com>

Email search by domain

<http://emailbydomain.com>

Auto manuals search

<http://auto.somanuals.com>

TV manuals search

<http://tv.somanuals.com>