

OWNER'S MANUAL

Palsonic

**68CM CORDLESS REMOTE LCD TELEVISION & MONITOR
MODEL: TFTV680S**



N111

**PALSONIC CORPORATION PTY LTD
1 JOYNTON AVENUE
WATERLOO NSW 2017 AUSTRALIA
TEL: (02) 9313 7111
FAX: (02) 9313 7555
www.palsonic.com.au**

**PALSONIC CUSTOMER SERVICE
TELEPHONE
AUSTRALIA: 1300 657 888**

Table of Contents

Important Safety Precautions	1
Preparations	3
Using the Remote Control	3
Batteries for the Remote Control	3
Antenna Connection	4
Power Connection	4
Identification of Controls	5
Main Unit	5
Remote Control	7
Connections	9
Cautions before connecting	9
Connect a AVI or S-Video Inputs	9
Connect a DVD Player	10
Connect a DTV Receiver	11
Connect a PC	11
Connect A VCR for Recording	12
Turning the Unit On and Off	13
Turning the Unit On or Off.....	13
Viewing the Menus and Displays	13
Viewing TV Programs	14
Select a Region	14
Storing Channels in Memory Automatically	14
Manual Fine Tuning	14
Manual Search	15
Skipping Channel	15
Editing Channels	15
Setting Favourite Channel	16
Editing Program Name	16
Locking TV Channels	17
Setting Locking Function On or Off	17
Locking or Unlocking TV Channels	17
Changing Password	17
Basic Operations	18
Changing Channels	18
Adjusting the Volume	18
Muting the Sound	18
Select Input Source Signal	18
Setting Picture	19
Using the Preset Picture Mode	19
Customising the Picture	19
Reducing Picture Noise	19
Freezing Picture	19

Table of Contents (continued)

Setting Sound	20
Adjusting the Volume	20
Adjusting the Sound Balance	20
Adjusting the Headphone Volume	20
Adjusting Equaliser	20
Setting SRS Effect	21
Stereo/Bilingual Selection	21
Setting System	22
Setting Colour System	22
Setting Sound System	22
Changing Screen Aspect Ratio	22
Setting Menu Language	23
Setting Menu Background	23
Setting Blue Screen	23
Setting Sleep Timer	23
Setting Current Time/Turn Off Timer/Turn On Timer	23
Changing Screen Layout	24
Selecting Screen Layout	24
PIP Operations	25
Viewing the Picture-in-Picture	25
Using PIP-POS button	25
Using Active-WIN Button	25
Swap the Contents of the PIP Image and Main Image	25
Adjustment in D-Sub/DVI Mode	26
Adjusting Image Horizontal Size	26
Changing the Position of Image	26
Fine Tune	26
Adjusting the Screen Automatically	26
Smoothing the Picture	27
Loading Default Values	27
Advanced Adjustment for Image Position	27
Teletext	28
What is Teletext	28
Turning On and Off Teletext	28
Button Functions	28
Troubleshooting	29
Specifications	30

Important Safety Precautions

Electrical energy can perform many useful functions, but it can also cause personal injuries and property damage if improperly handled. This product has been engineered and manufactured with the highest priority on safety. But **IMPROPER USE CAN RESULT IN POTENTIAL ELECTRICAL SHOCK OR FIRE HAZARD.** In order to prevent potential danger, please observe the following instructions when installing, operating and cleaning the product. To ensure your safety and prolong the service life of your LCD TV product, please read the following precautions carefully before using the product.

- 1. Read these instructions** --- All operating instructions must be read and understood before the product is operated.
- 2. Keep these instructions** --- These safety and operating instructions must be kept in a safe place for future reference.
- 3. Read all warnings** --- All warnings on the product and in the instructions must be observed closely.
- 4. Follow all instructions** --- All operating instructions must be followed.
- 5. Attachments** --- Only use attachments/accessories specified by the manufacturer. Do not use attachments not recommended by the manufacturer. Use of improper attachments can result in accidents,
- 6. Power source** --- This product is intended to be supplied by a listed power supply indicated on the marking label. If you are not sure of the type of power supply to your home, consult your product dealer or local power company. For added protection for this product during a lightning storm, or when it is left unattended and unused for long periods of time, unplug it from the wall outlet and disconnect the cable system.
- 7. Power cord protection** --- Protect the power cord from being walked on or pinched particularly at plugs, convenience receptacles, and the point where they exit from the apparatus.
- 8. Overloading** --- Do not overload wall outlets, extension cords, or convenience receptacles on other equipment as this can result in a risk of fire or electric shock.
- 9. Entering of objects and liquids** --- Never insert an object into the product through vents or openings. High voltage flows in the product, and inserting an object can cause electric shock and/or short internal parts. For the same reason, do not spill water or liquid on the product.
- 10. Servicing** --- Refer all servicing to qualified service personnel. Servicing is required when the apparatus has been damaged in anyway, such as power-supply cord or plug is damaged, liquid has been spilled or objects have fallen into the apparatus, the apparatus has been exposed to rain or moisture, does not operate normally, or has been dropped.
- 11. Damage requiring service** --- If any of the following conditions occurs, unplug the power cord from the AC outlet, and request a qualified service person to perform repairs.
 - a. When the power cord or plug is damaged.
 - b. When a liquid is spilled on the product or when objects have fallen into the product.
 - c. When the product has been exposed to rain or water.
 - d. When the product does not operate properly as described in the operating instructions.
Do not touch the controls other than those described in the operating instructions. Improper adjustment of controls not described in the instructions can cause damage, which often requires extensive adjustment work by a qualified technician.
 - e. If the product has been dropped or the cabinet has been damaged in anyway.
 - f. When the product displays an abnormal condition or exhibits a distinct change in performance. Any noticeable abnormality in the product indicates that the product needs servicing.
- 12. Replacement parts** --- In case the product needs replacement parts, make sure that the service person uses replacement parts specified by the manufacturer, or those with the same characteristics and performance as the original parts. Use of unauthorised parts can result in fire, electric shock and/or other danger.
- 13. Safety checks** --- Upon completion of service or repair work, request the service technician to perform safety checks to ensure that the product is in proper operating condition.
- 14. Wall or ceiling mounting** --- When mounting the product on a wall or ceiling, be sure to install the product according to the method recommended by the manufacturer. This is a safety feature.

Important Safety Precautions (continued)

15. Stand --- Use only with the cart, stand, tripod, bracket, or table specified by the manufacturer, or sold with the apparatus. Do not place the product on an unstable trolley, stand, tripod or table. Placing the product on an unstable base can cause the product to fall, resulting in serious personal injuries as well as damage to the product. When mounting the product on a wall, be sure to follow the manufacturer's instructions. Use only the mounting hardware recommended by the manufacturer.

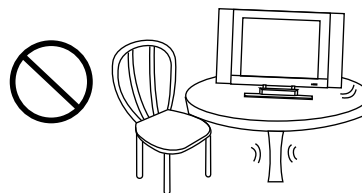

16. Careful move --- When a cart is used, use caution when moving the cart/apparatus combination to avoid injury from tip-over. Sudden stops, excessive force and uneven floor surfaces can cause the product to fall from the trolley.



17. Lightning --- Unplug this apparatus during lightning storms or when unused for long periods of time.

For added protection for this television equipment during a lightning storm, or when it is left unattended and unused for long periods of time, unplug it from the wall outlet and disconnect the antenna. This will prevent damage to the equipment due to lightning and power-line surges.

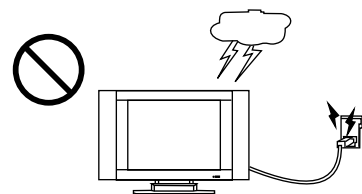

18. Do not use this apparatus near water --- for example, near a bathtub, washbowl, kitchen sink, or laundry tub, in a wet basement, or near a swimming pool, and the like. Do not use immediately after moving from a low temperature to high temperature environment, as this causes condensation, which may result in fire, electric shock, or other hazards.



19. Clean only with dry cloth --- Unplug this product from the wall outlet before cleaning. Do not use liquid cleaners or aerosol cleaners. Use a damp cloth for cleaning.

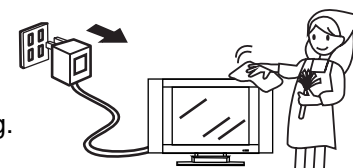

20. Ventilation --- Do not block any ventilation openings. Install in accordance with the manufacturer instructions. The vents and other openings in the cabinet are designed for ventilation. Do not cover or block these vents and openings since insufficient ventilation can cause overheating and/or shorten the life of the product. Do not place the product on a bed, sofa, rug or other similar surface, since they can block ventilation openings. This product is not designed for built-in installation; do not place the product in an enclosed place such as a bookcase or rack, unless proper ventilation is provided or the manufacturer's instructions are followed.

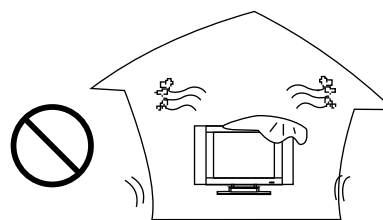

21. Heat sources --- Do not install near any heat sources such as radiators, heat registers, stoves, or other apparatus (including amplifiers) that produce heat.

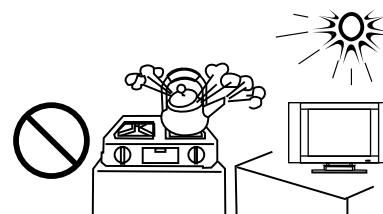

22. Panel protection --- The LCD panel used in this product is made of glass. Therefore, it can break when the product is dropped or impacted upon by other objects. Be careful not to be injured by broken glass pieces in case the LCD panel breaks.

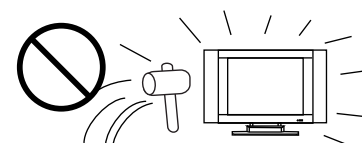

23. Pixel defect --- The LCD panel is a very high technology product, giving you finely detailed pictures. Occasionally, a few non-active pixels may appear on the screen as a fixed point of blue, green or red. Please note that this does not affect the performance of your product.

Using the Remote Control

- Use the remote control by pointing it towards the remote sensor window of the set. Objects between the remote control and sensor window may prevent proper operation.

Note: the illustration is for your reference only, the remote sensor may locate differently with different model.

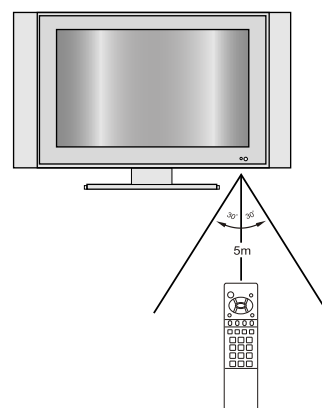

Cautions regarding use of remote control

- Do not expose the remote control to shock. In addition, do not expose the remote control to liquids, and do not place in an area with high humidity.
- Do not install or place the remote control under direct sunlight. The heat may cause deformation of the unit.
- The remote control may not work properly if the remote sensor window of the main unit is under direct sunlight or strong lighting. In such a case, change the angle of the lighting or LCD TV set, or operate the remote control closer to the remote sensor window.

Batteries for the Remote Control

If the remote control fails to operate the LCD TV functions, replace the batteries in the remote control.

1 Open the battery cover.

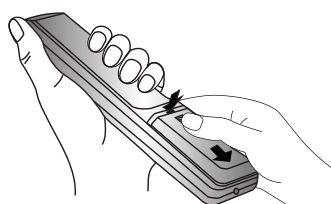

2 Insert two size-AAA batteries.

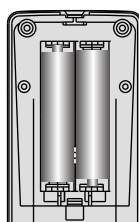

3 Replace the cover and slide in reverse until the lock snaps.

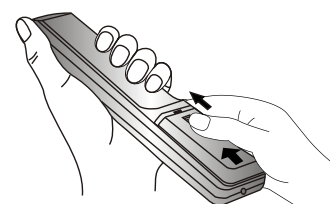

■ (Slide the cover while pressing down.)

■ (Place the batteries with their terminals corresponding to the (+) and (-) indications in the battery compartment.)

Precautions on battery use

Improper use of batteries can result in a leakage of chemicals and/or explosion. Be sure to follow the instructions below.

- Place batteries with their terminals corresponding to the (+) and (-) indications.
- Different types of batteries have different characteristics. Do not mix batteries of different types.
- Do not mix old and new batteries. Mixing old and new batteries can shorten the life of new batteries and/or cause old batteries to leak chemicals.
- Remove batteries as soon as they are non-operable. Chemicals that leak from batteries can cause a rash. If chemical leakage is found, wipe with a cloth.
- The batteries supplied with the product may have a shorter life expectancy due to storage conditions.
- If the remote control is not used for an extended period of time, remove the batteries from the remote control.

Antenna Connection

INSTALL the unit in a room where direct light will not fall upon the screen. Total darkness or a reflection on the picture screen may cause eyestrain. Soft and indirect lighting is recommended for comfortable viewing.

Optimum reception of colour requires a good signal and will generally mean that an outdoor aerial must be used. The exact type and position of the aerial will depend upon your particular area.

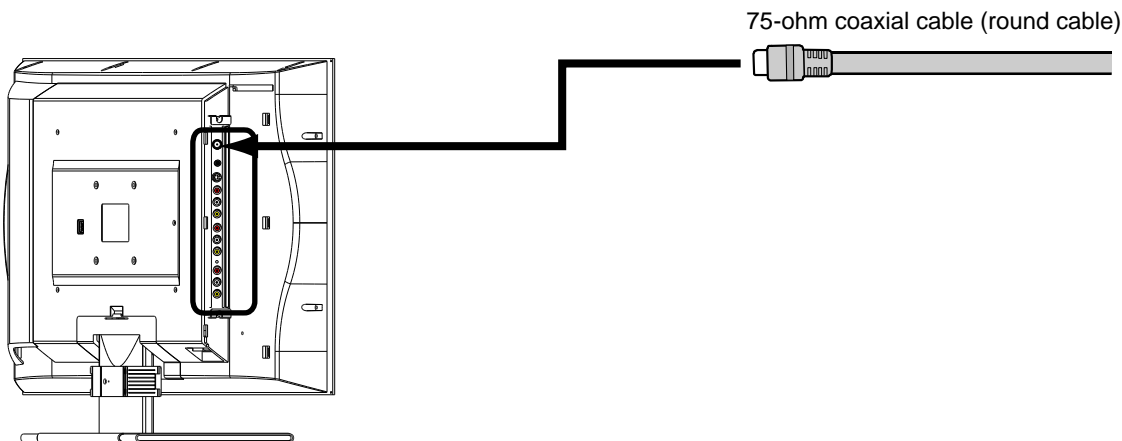

Note:

It is recommended that the 75-ohm coaxial cable be used to eliminate interference and noise which may occur due to radio wave conditions.

The aerial cable should not be bundled with the power cord and the like.

Power Connection

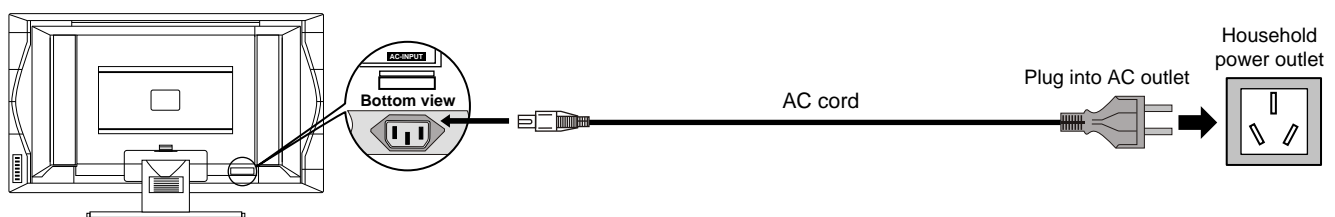

1. Connecting the female plug to the AC socket on the unit.
2. Connecting the male plug to the wall outlet as illustrated.

Note:

- *This product should be operated only from the type of power source indicated on the marking label.*
- *Always unplug the AC cord from power outlet when not using for a long period of time.*
- *This illustration is for reference only. The AC plug may be different on different models.*

Identification of Controls

Main Unit

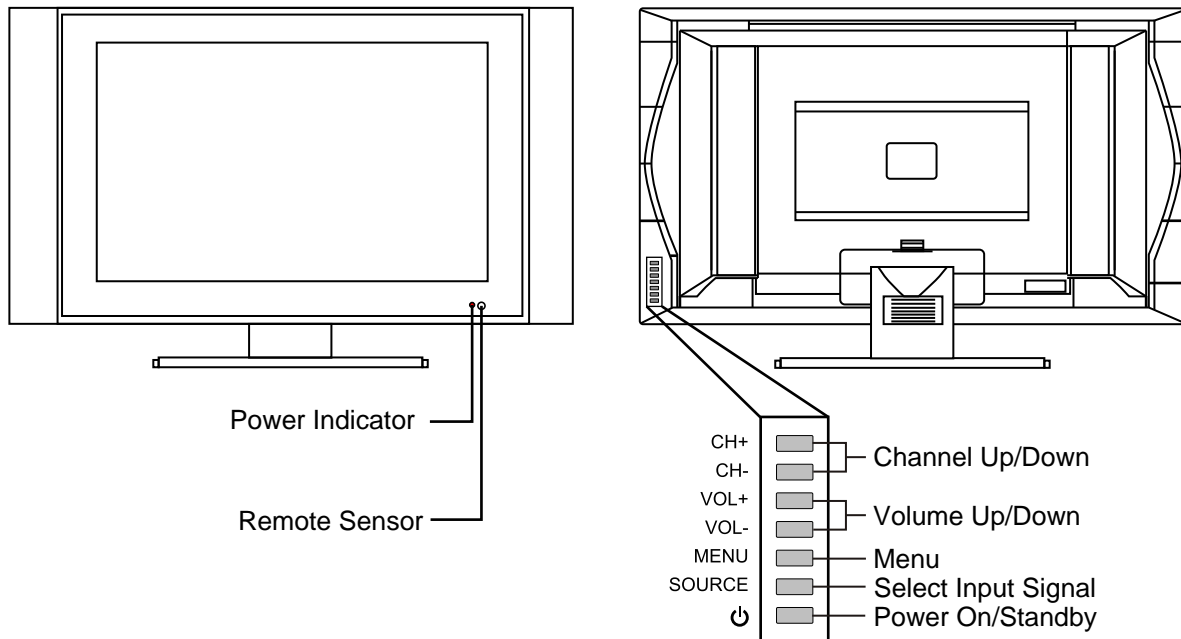

1. POWER

Press this button to turn the unit ON from STANDBY mode. Press it again to turn the set back to STANDBY.

2. SOURCE

To access signal source select menu

In OSD Menu, press this button to confirm your setting or operation

3. MENU

Press this button to access the Menu main page

4. VOL+/-

Press the **VOL+** or **VOL-** button to directly increase or decrease the sound volume level;

In OSD Menu, press these buttons to adjust the value or setting of each item

5. CH+/-

Press these two buttons to directly change the TV channel;

In OSD Menu, press these buttons to choose the OSD items

Note:

*Functions of **VOL+/-**, **CH+/-**, **MENU**, **SOURCE** and **POWER ** are also provided to the remote control. This operation manual provides a description based on operating functions with the remote control.*

Main Unit

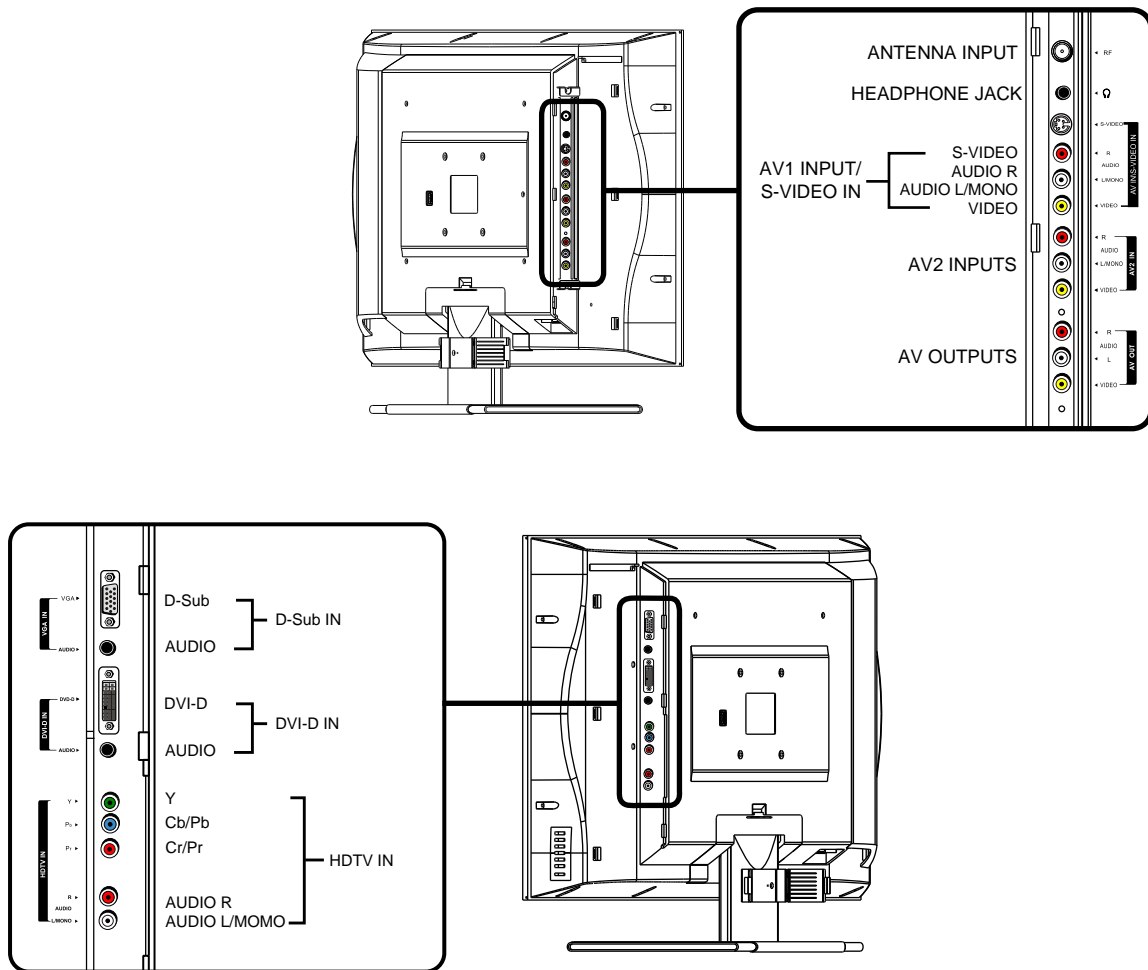

1. Antenna input

Allows you to connect cable or outdoor antenna

2. Headphone jack

3. AV1 inputs (Video, Audio L/Mono, R) / S-Video input

Receive video/audio signals from external sources such as VCR or DVD player.

Receive a S-Video signal from external source such as VCR or DVD player.

4. AV2 Inputs

5. AV Outputs

6. D-Sub input / Audio in

Connect to the D-Sub/audio output jacks on your PC.

7. DVI input / Audio in

Receives the digital video / audio signals from a set top box or PC.

8. HDTV inputs (Y, Pb/Cb, Pr/Cr, Audio L/MONO, R)

Connect to the component and audio output jacks of a DVD player or Set-Top Box.

Identification of Controls (continued)

Remote Control

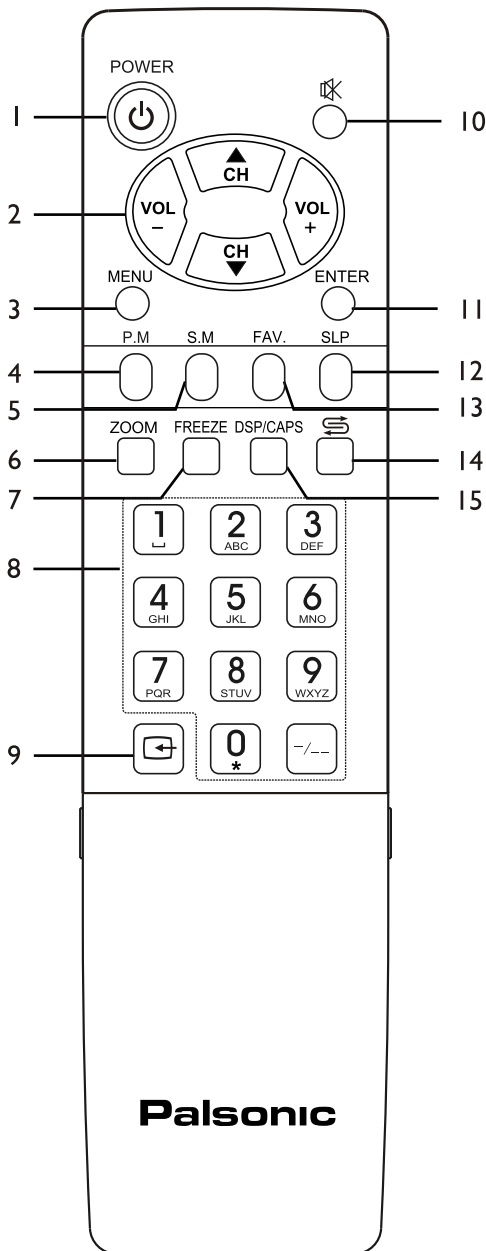

1. POWER Turn the unit on or standby.
2. CH ▲/▼, VOL+/-
CH ▲/▼ - Use to switch channels;
- To display previous/next page (Teletext)
VOL+/- - Use to adjust volume;
In MENU operation, use CH ▲/▼ to select menu item and VOL+/- to adjust selected item.
3. MENU
To access the MENU main page.
In Menu operation, press this button to return to a higher level menu.
4. P.M
To quickly select picture mode.
Red button (Teletext)
5. SM
To quickly select sound mode.
Green button (Teletext)
6. ZOOM
To select Screen Aspect Ratio
This button doesn't work under [POP], [6 Windows], [9 Windows]
7. Freeze
To freeze current picture.
8. 0~9 digit buttons, -/-- button
0~9: Direct channel select;
To in put character when editing channel label
-/-- button; one digit/2 digit/3 digit channel number selector.
9. SOURCE To access source select menu
10. MUTE Sound mute
11. ENTER
To confirm your operation or setting or access the submenu
12. SLP
To access Sleep timer setting menu.
Blue button (Teletext).
13. FAV
To cycle among all favourite channel.
Yellow button (Teletext).
14. RETURN To quickly jump between current channel and last selected channel.
To switch to previous source.
15. DSP/CAPS
To display current channel status.
To switch between upper case and lower case input mode when editing channel label.

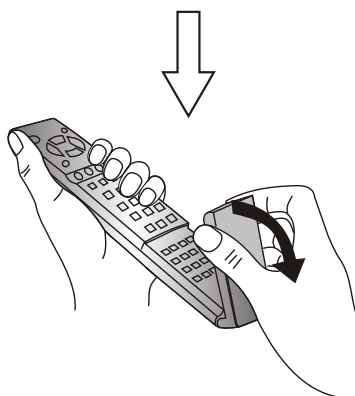

Flip the cover, open in the direction of the arrow.

Identifications of Controls (continued)

Remote Control

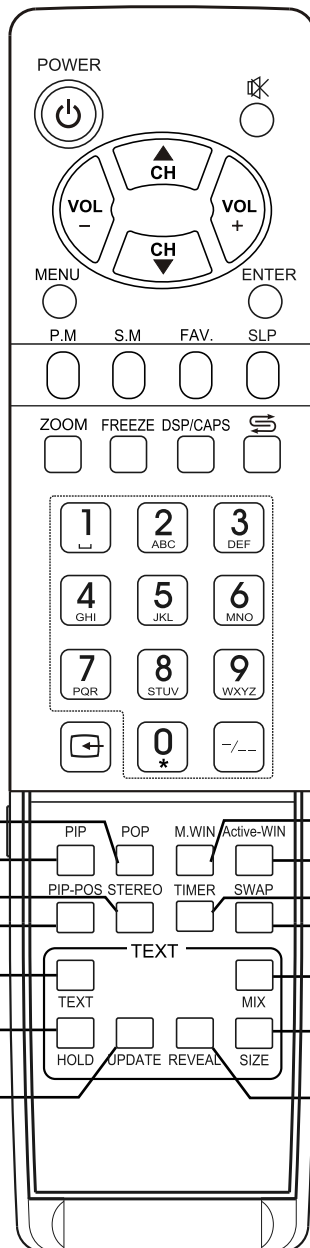

- 16. POP
To activate picture-out-picture
- 17. PIP
To activate picture-in-picture
- 18. STEREO
To select stereo, mono, bilingual
To rectify the picture automatically in D-Sub mode
- 19. PIP-POS
To select PIP frame position
- 20. TEXT
To enter/exit teletext mode (Teletext)
- 21. HOLD
To hold the current teletext page temporarily (Teletext)
- 22. UPDATE
To view update Teletext page (Teletext)
- 23. M.WIN
To select to view multi window mode
- 24. Active-WIN
To select the main picture frame or PIP frame when viewing picture-in-picture
- 25. TIMER
To set current time, turn-off timer or turn-on timer
- 26. SWAP
In full screen of TV program, press this button to access channel editing mode
When viewing PIP TV program, press this button to exchange the Contents of the PIP Image and Main Image
- 27. MIX
To superimpose text on the TV picture (Teletext)
- 28. SIZE
To expand top half or bottom half page of the current screen (Teletext)
- 29. REVEL
To display hidden information such as solution to riddles and puzzles (Teletext)

Connections

Cautions before connecting

- Carefully check the terminals for position and type before making any connections.
- The illustration of the external equipment may be different depending on your model.
- Loose connectors can result in image or colour problems. Make sure that all connectors are securely inserted into their terminals.
- Refer to the operating manual of the external device as well.
- When connecting an external device, turn the power off on the panel to avoid any issues.

Connect AVI or S-Video inputs

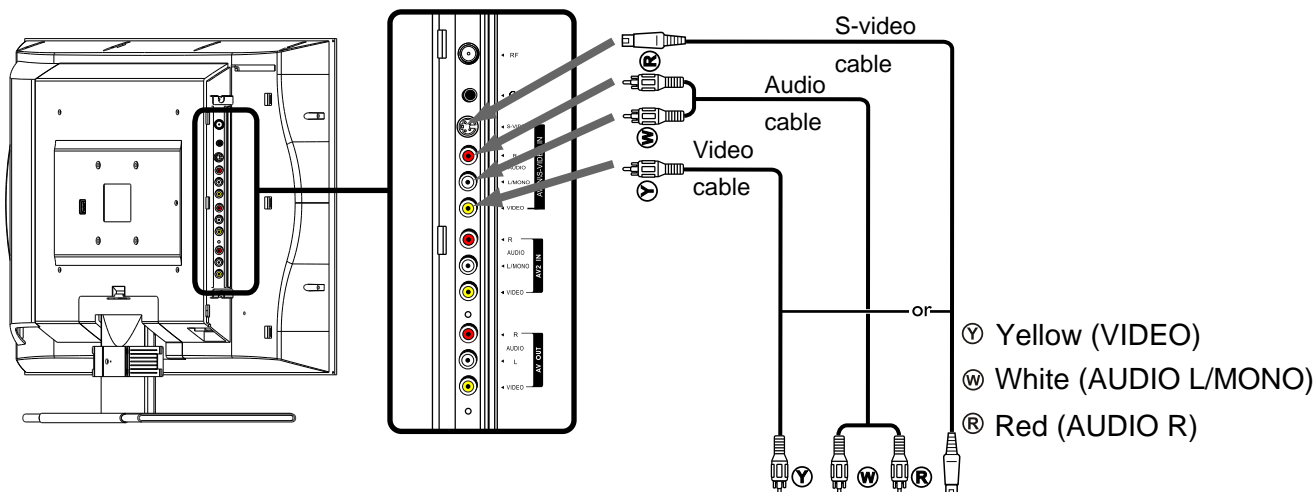

Examples of external devices that can be connected



VCR

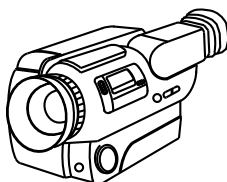

Video Camera

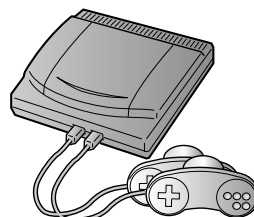

Home video game system

The unit provides Audio/Video inputs for you to connect external devices such as VCR, Video Camera or Home video game system.

How to connect:

Connect the Audio/Video cables between the Audio (L/R)/Video jacks on the unit and external devices.

To view signal from AV 1/S-VIDEO inputs

1. Turn on your LCD TV, press **SOURCE** button on the remote control.
2. Press **CH** / to select **Video** or **S-Video** and press **ENTER** to confirm.
3. Turn on the external device and play it.

Select Main Source

1. TV
2. Video 1
3. Video 2
4. S-Video
5. YPbPr
6. D-Sub
7. DVI

Note:

For better video, you can use the **S-Video** terminal if your source supports it. If you are going to use **S-Video** terminal, please select **S-Video** instead of **Video 1** in source menu

The **Video** input terminal on the **AV1 IN** and the **S-Video** input terminal share the same **Audio** input terminals.

Connections (continued)

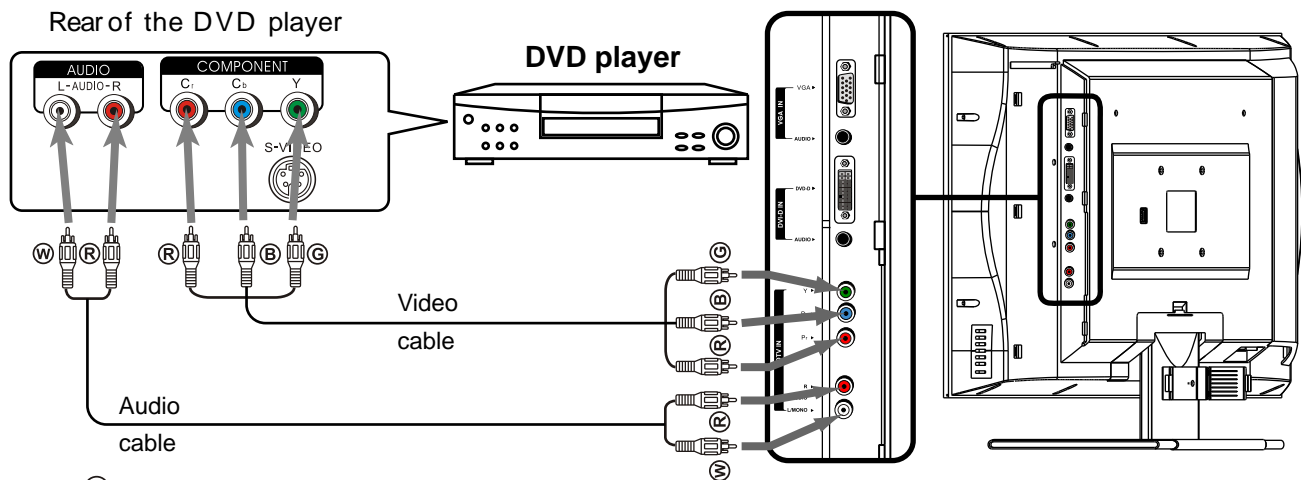

Connect a DVD Player



How to connect a DVD Player using Component Video Connections:

Connect the Video cable between the Y, Cb, Cr input jacks on the unit and Y, Cb, Cr output jacks on the DVD player. Connect the Audio cable between the AUDIO input jack on the unit and AUDIO output jacks on the DVD player.

To play DVD

1. Turn on your LCD TV, press **SOURCE**  button on the remote control.
2. Press **CH**  /  to select **YPbPr**.
3. Press **ENTER** to confirm.
4. Turn on your DVD player, insert a DVD disc and press the Play button.

Select Main Source
1. TV
2. Video 1
3. Video 2
4. S-Video
5. YPbPr
6. D-Sub
7. DVI

Note:

The Y, Cb, Cr outputs on your DVD player are sometimes labelled Y, Pb, Pr or Y, B-Y, R-Y. If so, connect the cables to like colours.

Connect a DTV receiver

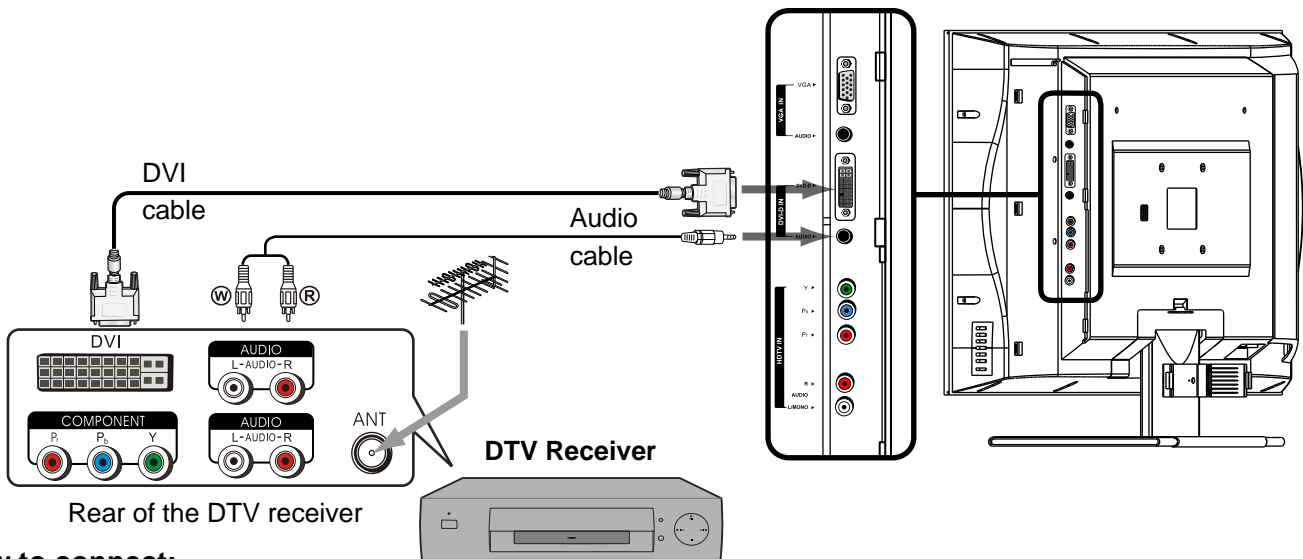

How to connect:

Connect the cable or antenna to the antenna input jack on the DTV receiver. Connect the DVI cable between the DVI input interface on the unit and DVI output interface on the DTV receiver. Connect the Audio cable between the AUDIO input jack on the unit and AUDIO output jacks on the DTV receiver.

To Watch DTV

1. Turn on your LCD TV, press **SOURCE** button on the remote control
2. Press **CH ▲/▼** to select **DVI**.
3. Press **ENTER** to confirm.
4. Turn on your DTV receiver.

Select Main Source

1. TV
2. Video 1
3. Video 2
4. S-Video
5. YPbPr
6. D-Sub
7. DVI

Connect a PC

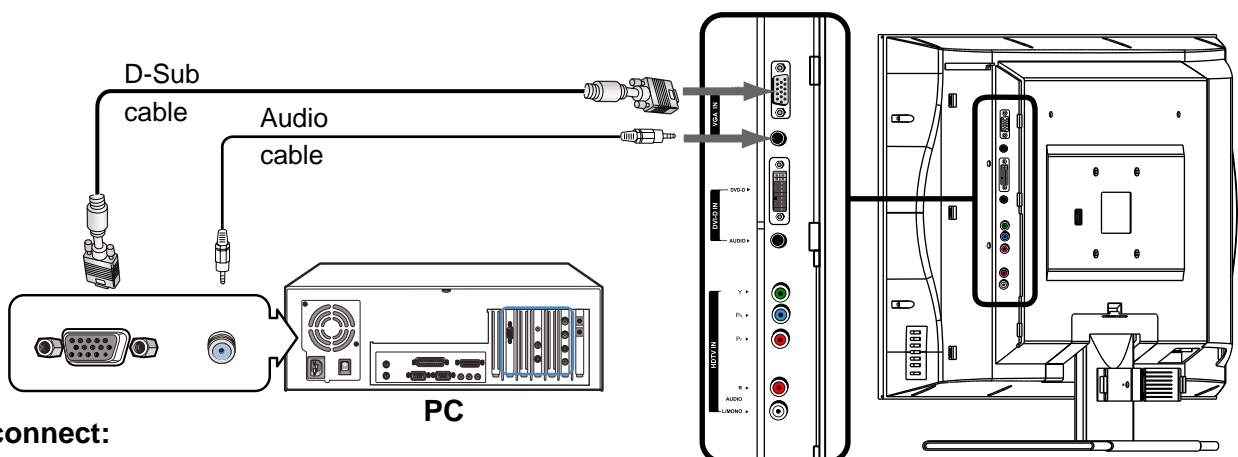

How to connect:

Connect a D-Sub cable between the S-Sub interface on the PC the D-Sub interface on the unit. Connect an Audio cable between the AUDIO output on the PC and AUDIO input jack on the unit.

To Watch the PC screen

1. Turn on your LCD TV, press **SOURCE** button on the remote control.
2. Press **CH ▲/▼** to select **D-Sub (D-Sub)**.
3. Press **ENTER** to confirm.
4. Turn on your PC and check for PC system requirements.
5. Adjust the PC screen.

Select Main Source

1. TV
2. Video 1
3. Video 2
4. S-Video
5. YPbPr
6. D-Sub
7. DVI

Connect a VCR for Recording

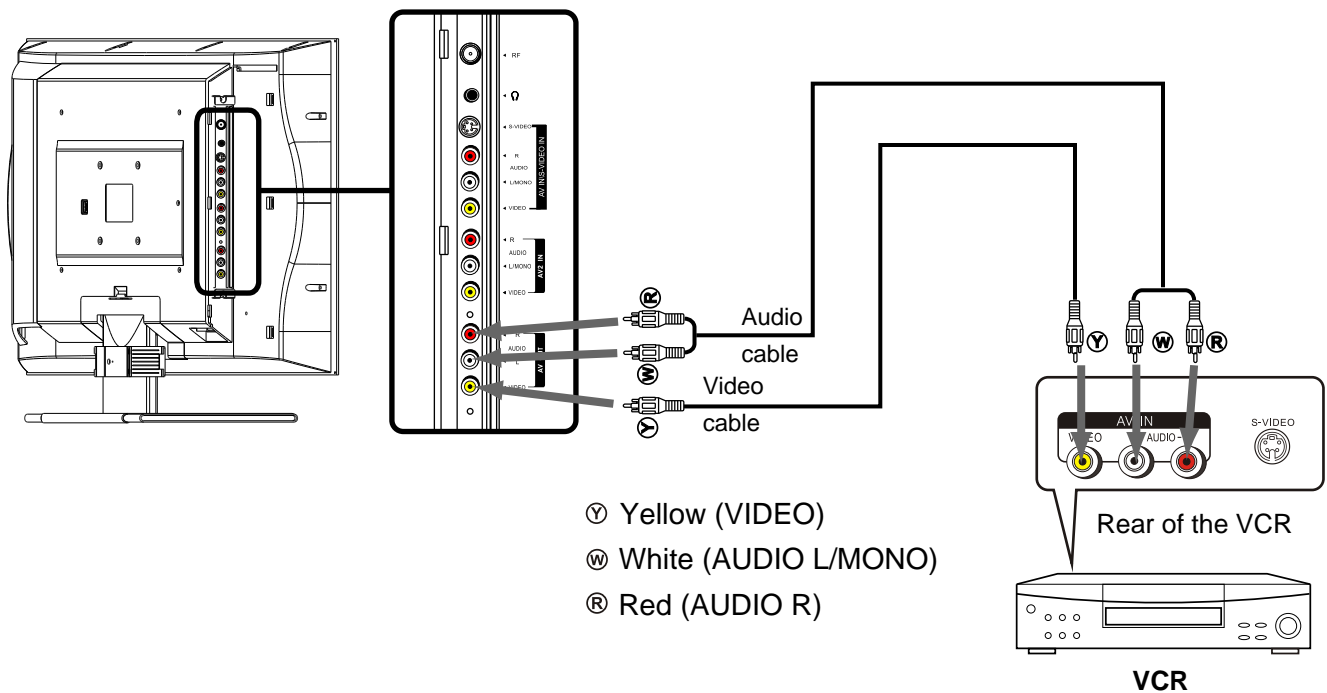

How to connect:

Connect the Audio/Video cables between the Audio (L/R)/Video jacks on the unit and Audio (L/R)/Video jacks on the VCR.

To play VCR

1. Turn on your LCD TV, select a program you wish to record.
2. Turn on your VCR, insert a video tape for recording.
3. Press the Record button to begin recording.

Note:

The signal inputted from the D-Sub or YPbPr/YCbCr terminal can not be output again.

Turning the Unit On and Off

Turning the Unit On and Off

Turning On

Insert the power cord into the wall outlet.
 Press the **Power**  button on the remote control.
 The unit will be turned on and you will be ready to use it's features.

Turning Off

With the power on, Press the **Power**  button on the remote control to turn off.

Note:

You can also use the **Power**  button on the Control panel on the main unit.

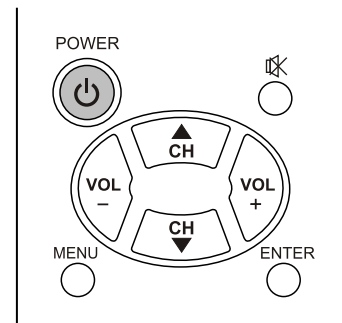

Viewing the Menus and Displays

Your LCD TV has a simple, easy-to-use menu system that appears on the screen. This system makes it convenient and fast to use features on the unit.

Viewing the Menus

- 1 With the power on, press the **MENU** button on the remote control. The main menu appears on the screen.
- 2 Use the **VOL+/-** to select menu page. Use **CH ^/▼** to activate the menu page.
- 3 Use the **CH ^/▼** to select item. Use **VOL+/-** to adjust value or setting of each item. Use **MENU** to exit menu system. On-screen menu will disappear from the screen automatically after some seconds, or you can press the **MENU** button repeatedly to exit the menu system.

Note:

- In Menu operations, you may use the **SOURCE** button on the unit to confirm your operation or setting just as the **ENTER** button on the remote control.
- In Menu operations, you may use **CH ^/▼** to select item or just press the relevant number button according to the number indicated on the left of the menu item.
- To clearly introduce the menu operations, this operation manual provides a description based on operation with the remote control.

Video	Audio	Screen	Program	Option
1. Mode:				Standard
2. Contrast				50
3. Brightness				50
4. Colour				50
5. Hue				00
6. Sharpness				50
7. DNR				Auto

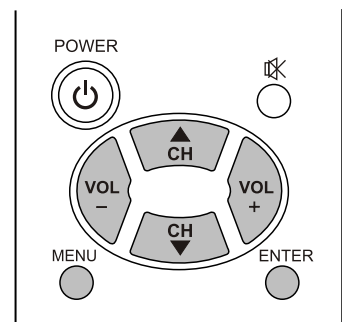

Displaying Status Information

The unit displays current status information (e.g channel number, channel name, channel locking status, colour and sound system or stereo mode) by pressing the **DSP/CAPS** button.

1. Information for main picture frame
2. Current channel name
3. Favourite channel icon
4. Locked status icon
5. Current channel number
6. Sound system
7. Stereo mode
8. Nicam status
9. Colour system

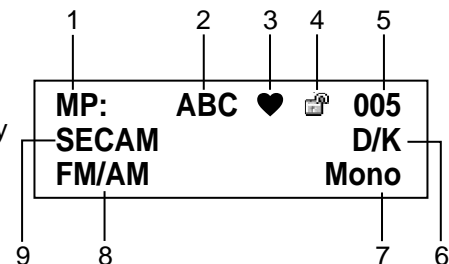

Note:

Some of the above items are not always displayed on the screen and they are subject to your settings.

Viewing TV Programs

Your LCD TV can memorise and store all of the available channels. After the available channels are memorised, use **CH ▲/▼** to scan through the available stations.

Select a Region

Before you start automatic search, it is necessary to select a region firstly.

- 1 Press **MENU** to display the menu main page.
- 2 Press **VOL+/-** repeatedly to display **Option** menu page.
- 3 Press **CH▼** repeatedly to select **Country** item.
- 4 Press **VOL+** or **ENTER** to access the sub-menu.
- 5 Press **CH▲/▼** to select a region.
Please select a proper region according to your area.
To search and memorise the SECAM-L/L' programs, you need to select [France].
- 6 Press **ENTER** to confirm and press **MENU** repeatedly to exit.

Video	Audio	Screen	Program	Option
1. Main Display Source:				TV
2. Display Mode:				Auto
3. PIP Mode:				Off
4. MultiWin Mode:				Off
5. Child Lock:				Off
6. Change Password				
7. Menu Language:				English
8. Country:				Others...
9. Menu Background:				Transparent
0. Blue Screen:				On

UK
Germany
France
Italy
Spain
Others...

Storing Channels in Memory Automatically

- 1 Press **MENU** to display the menu main page.
- 2 Press **VOL+/-** repeatedly to display **Program** menu page.
- 3 Press **CH▼** repeatedly to select **Auto Search** item.
- 4 Press **VOL+** or **ENTER** to store channels in memory automatically.
The process will begin memorising all of the available channels.

Note:

The process of auto memory will be stopped if you press the **MENU** button

During the process of auto Search, the unit automatically identifies and stores the program name if the program's name is available.

If the program's name is with more than 5 characters, the unit only stores the first 5 characters.

Video	Audio	Screen	Program	Option
1. Program No:				5
2. Program Name:				
3. Locked:				Off
4. Skip:				Off
5. Favourite:				Off
6. Fine Tuning				00
7. Colour System:				AUTO
8. Sound System:				B/G
9. Auto Search				
0. Manual Search				

Auto Search Program	010
49.65MHz	VHF-L

Manual Fine Tuning

- 1 Press **MENU** to display the menu main page.
- 2 Press **VOL+/-** repeatedly to display **Program** menu page.
- 3 Press **CH▼** repeatedly to select **Fine Tuning** item.
- 4 Press **VOL+/-** to fine tune till the best possible picture and sound are obtained.
- 5 Press **MENU** to exit.

Video	Audio	Screen	Program	Option
1. Program No:				5
2. Program Name:				
3. Locked:				Off
4. Skip:				Off
5. Favourite:				Off
6. Fine Tuning				00
7. Colour System:				AUTO
8. Sound System:				B/G
9. Auto Search				
0. Manual Search				

Viewing TV Programs (continued)

Manual Search

Use **Manual Search** if desired channels can not be memorised or if you would like to store programs to specific channel numbers one by one.

- 1 Use **number buttons** to directly select a channel that you want to perform manual search.
- 2 Press **MENU** to display the menu main page.
- 3 Press **VOL+/-** repeatedly to display **Program** menu page.
- 4 Press **CH▼** repeatedly to select **Manual Search** item.
- 5 YOU may press **ENTER** to input a frequency or press **VOL+/-** to search program from current frequency.
 - ▶ To search program manually by inputting a frequency:
 1. Press **ENTER** the unit allows you to input a frequency.
 2. Input the desired frequency by using **0-9 buttons**.
 3. Press **ENTER** to confirm and the unit locates to your frequency. If you want to exit, press **MENU** again.



- ▶ To search program manually from current frequency: Pressing **VOL+**, the unit searches towards higher frequency; Pressing **VOL-**, the unit searches towards lower frequency; The search stops when a program is found and this program will be stored in current channel. During process of manual search, you may control the searching direction by pressing **VOL+** or **VOL-**.

Video	Audio	Screen	Program	Option
1. Program No:				5
2. Program Name:				
3. Locked:				Off
4. Skip:				Off
5. Favourite:				Off
6. Fine Tuning				00
7. Colour System:				AUTO
8. Sound System:				B/G
9. Auto Search				
0. Manual Search				

↓ Press ENTER

7. Colour System:				AUTO
8. Sound System:				B/G
9. Auto Search				
0. Manual Search			 MHz

Manual Search Program		005
49.65MHz		
		VHF-L

Skipping Channel

- 1 Use **number buttons** to directly select a channel that you want to skip.
- 2 Press **MENU** to display the menu main page.
- 3 Press **VOL+/-** repeatedly to display **Program** menu page.
- 4 Press **CH▼** repeatedly to select **Skip** item.
- 5 Press **VOL+** or **ENTER** to access the sub-menu.
- 6 Press **CH▲/▼** to select **On** or **Off**.
- 7 Press **ENTER** to confirm and press **MENU** repeatedly to exit. When the item is set to on, the selected channel will be skipped. When the item is set to off, the selected channel will not be skipped. The skipped channels can not be selected by using the **CH▲/▼** buttons unless you use **number buttons** to input channel number directly.

Video	Audio	Screen	Program	Option
1. Program No:				5
2. Program Name:				
3. Locked:				Off
4. Skip:				On
5. Favourite:				Off
6. Fine Tuning				00
7. Colour System:				AUTO
8. Sound System:				B/G
9. Auto Search				
0. Manual Search				

Off
On

Editing Channels

The **edit channels** function is for you to arrange channel order as you wish.

When viewing single TV screen, press **SWAP** to display **Channel Swap** menu. The current channel number appears in the [Program No.] item.

Press **CH▼** to select **Sorted No.** item.

Press **VOL+/-** to select a target channel which is to be exchanged with the current channel.

Press **CH▼** to select and highlight **OK** item.

Press **ENTER** to confirm exchanging contents in current channel and the target channel.

Program No.:	001
Sorted No.:	005
OK?	

Setting Favourite Channel

- 1 Press **MENU** to display the menu main page.
- 2 Press **VOL+/-** repeatedly to display **Program** menu page.
- 3 Press **CH▼** to select **Program No** item.
- 4 Press **VOL+/-** to select a channel that you want to set as your favourite channel.
- 5 Press **CH▼** repeatedly to select **Favourite** item.
- 6 Press **VOL+** or **ENTER** to access the sub-menu.
- 7 Press **CH▲/▼** to select **On** or **Off**.
- 8 Press **ENTER** to confirm and press **MENU** repeatedly to exit.

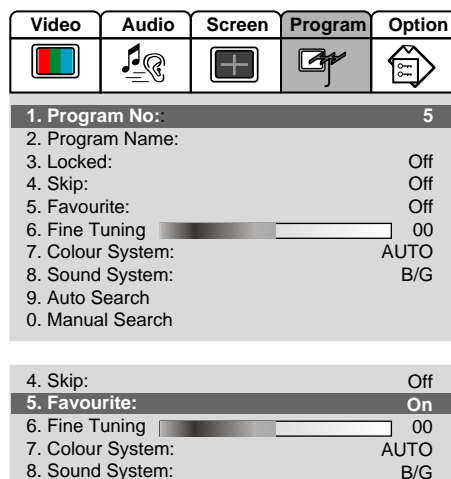

You can repeat the above steps to set more favourite channels so that you can cycle among your favourite channels by pressing the **FAV.** button.

When you are viewing a favourite channel, a "♥" icon appears on the screen while pressing the **DSP/CAPS** button.

Editing Program Name

- 1 Use **number buttons** to directly select a channel you want to edit its name.
- 2 Press **MENU** to display the menu main page.
- 3 Press **VOL+/-** repeatedly to display **Program** menu page.
- 4 Press **CH▼** repeatedly to select **Program Name** item.
- 5 Press **ENTER** to edit program name.
 Use **VOL+/-** to move cursor right or left.
 Use **0~9** number buttons to input characters.
 Use **DSP/CAPS** to switch between lowercase and UPPERCASE.
 Use **CH▼** to delete a character.
 After you finish inputting, you may use **ENTER** to confirm and return.
 The maximum length of program name is 8 characters.

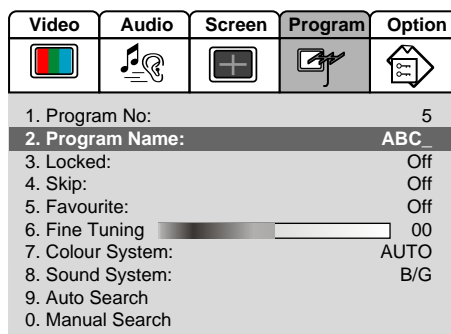

Button	Character List	Character List while pressing DSP/CAPS
0	0 * # ()	0 * # ()
1	1 - - . !	1 - - . !
2	2 a b c @	2 A B C @
3	3 d e f #	3 D E F #
4	4 g h i \$	4 G H I \$
5	5 j k l %	5 J K L %
6	6 m n o ^	6 M N O ^
7	7 p q r &	7 P Q R &
8	8 s t u v	8 S T U V
9	9 w x y z	9 W X Y Z



Locking TV Channels

Setting Locking Function On or Off

- 1 Press **MENU** to display the menu main page.
- 2 Press **VOL+/-** repeatedly to display **Option** menu page.
- 3 Press **CH▼** to select **Child Lock** item.
- 4 Press **VOL+** or **ENTER** to access the sub-menu.
- 5 Press **CH▲/▼** to select **On** or **Off**.
- 6 Press **ENTER** to confirm and press **MENU** repeatedly to exit.

Video	Audio	Screen	Program	Option
1. Main Display Source:				TV
2. Display Mode:				Auto
3. PIP Mode:				Off
4. MultiWin Mode:				Off
5. Child Lock:				Off
6. Change Password				
7. Menu Language:				English
8. Country:				Others ...
9. Menu Background:				Transparent
0. Blue Screen:				On

Off
On

If the [Child Lock] item is set to [On], the unit detects the child lock status for every channels while you changing channels or pressing the **DSP/CAPS** button. If current channel is detected as a locked channel , a "🔒" icon appears on the screen, otherwise a "📺" icon appears.

If you set the [Child Lock] item to [On], next time if you want to set the [Child Lock] item to [Off], the unit asks you to input password.

Locking or Unlocking TV Channels

If the [Child Lock] item is set to [On], the unit asks you to input password if you want to access the [Program] menu page.

- 1 Press **MENU** to display the menu main page.
- 2 Press **VOL+/-** repeatedly to display **Program** menu page.
- 3 Press **CH▼** to select **Program No** item.
- 4 Press **VOL+/-** to select a channel that you want to lock or unlock.
- 5 Press **CH▼** repeatedly to select **Locked** item.
- 6 Press **VOL+** or **ENTER** to access the sub-menu.
- 7 Press **CH▲/▼** to select **On** or **Off**.
- 8 Press **ENTER** to confirm and press **MENU** repeatedly to exit.
You can repeat the above steps to lock or unlock other channels.

Video	Audio	Screen	Program	Option
1. Program No:				05
2. Program Name:				
3. Locked:				On
4. Skip:				Off
5. Favourite:				Off
6. Fine Tuning				50
7. Colon System:				AUTO
8. Sound System:				B/G
9. Auto Search				
0. Manual Search				

Off
On

Restart the unit to active your setting.

The locking settings may not work unless you restart the unit.

When you select a locked channel, a "🔒" icon appears and the screen is blank. In this situation, if you still want to view the locked channel, you may follow these steps to unlock:

1. Press **FREEZE** to display password input page.
2. Enter the password. The default password is "000000".

Once the correct password is inputted, the unit allows you to view all locked channels.

Changing Password

- 1 Press **MENU** to display the menu main page.
- 2 Press **VOL+/-** repeatedly to display **Option** menu page.
- 3 Press **CH▼** to select **Change Password** item.
- 4 Press **ENTER** to confirm.
- 5 Input the old password.
- 6 Input the new password.
- 7 Input the new password again and then the password has been changed successfully.

Video	Audio	Screen	Program	Option
1. Main Display Source:				TV
2. Display Mode:				Auto
3. PIP Mode:				Off
4. MultiWin Mode:				Off
5. Child Lock:				Off
6. Change Password				
7. Menu Language:				English
8. Country:				Others ...
9. Menu Background:				Transparent
0. Blue Screen:				On

Old Password: *****

Be sure to write down your password and retain it for future use. If you forget the password, the unit provides a master password as "962326" for you to access the locked channels or change password. Please DO NOT let the children know the master password.

Changing Channels

Using the Channel Buttons (CH▲ or CH▼)

Press the **CH▲** or **CH▼** to change channels.

When you press the **CH▲** or **CH▼**, the unit changes channels in sequence. You will see all the channels that the unit has memorised.

You will not see channels that were skipped.

Direct Accessing Channels

Press the number buttons to go directly to a channel.

To select a one-digit channel:

Input the channel number by using the **0-9 number buttons** directly.

To select a two-digit channel:

Press **-/-** to display "- -" and input the channel number by using the **0-9 number buttons**.

To select a three-digit channel:

Press **-/-** to display "- - -" and input the channel number by using the **0-9 number buttons**.

Note:

When you use the number buttons, You may directly select channels that were skipped.

Using the RETURN ⇄ button

Press this button to switch between the current channel and the previous channel.

Adjusting the Volume

Using the volume buttons (VOL- and VOL+)

Press the **VOL+** or **VOL-** to increase or decrease the volume.

Muting the Sound

Using the MUTE 🔇 button

At any time, you can temporarily turn off the sound using the **MUTE 🔇** button.

1 Press the **MUTE 🔇** button and the sound turns off.

2 To turn mute off, press the **MUTE 🔇** button again.

Select input source signal

1 Press **SOURCE** ⇄ to access source select menu.

2 Press **CH▲/▼** to select a desired signal source.

You may directly press the relevant number button to select a desired signal source.

3 Press **ENTER** to confirm.

TV ----- select TV signal.

Video 1 ----- select signal from AV1 terminal.

Video 2 ----- select signal from AV2 terminal.

S-Video ----- select signal from S-Video terminal.

YPbPr ----- select signal from YPbPr or YCbCr terminals.

D-Sub ----- select signal from D-Sub (15-pin D-sub) terminals.

DVI ----- select signal from DVI terminals.

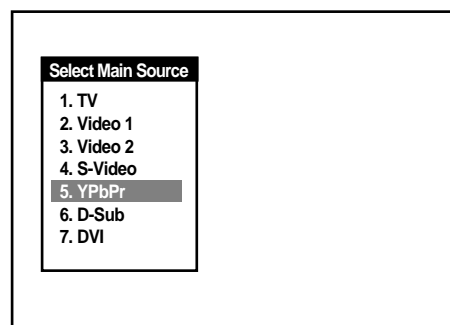

Note:

- You may quickly switch from other inputs to TV program by pressing the **number buttons** or **CH▲/▼**.

Setting Picture

Using the Preset Picture Mode

- 1 Press **MENU** to display the menu main page.
The [Video] menu page will be highlighted automatically.
- 2 Press **CH**▼ to select **Mode** item.
- 3 Press **VOL+** or **ENTER** to access the sub-menu.
- 4 Press **CH**▲/▼ to select a desired picture mode.
- 5 Press **ENTER** to confirm and press **MENU** repeatedly to exit.

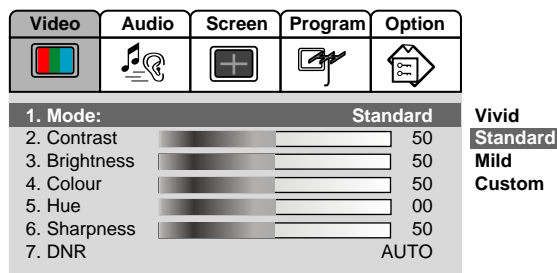

There are three preset picture modes [Vivid, Standard and Mild] and one user-set picture mode [Custom]. Each preset mode has its own picture settings.

[Vivid]: Select for a bright picture.

[Standard]: Select for a normal picture.

[Mild]: Select for a fine/soft picture.

You may directly use the **P.M** button on the remote control to select a desired picture mode.

Customising the Picture

- 1 Press **MENU** to display the menu main page.
The [Video] menu page will be selected automatically.
- 2 Press **CH**▼ to enter the menu and select item with **CH**▲ or **CH**▼.
- 3 Press **VOL+/-** to adjust the value of the item.
- 4 Press **MENU** to exit.

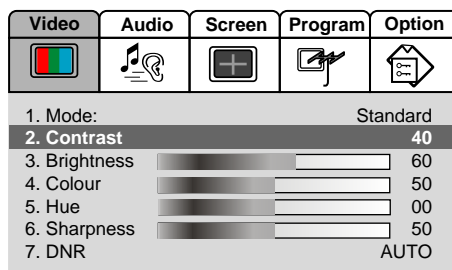

Adjustment item	Press VOL-	Value range	Press VOL+
Contrast	Decrease contrast	0 - 100	Increase contrast
Brightness	Less bright	0 - 100	More bright
Colour	Lower colour intensity	0 -100	Higher colour intensity
Hue *	Towards purple	-50 - +50	Towards green
Sharpness	Soft picture	0 - 100	Sharp picture

* The [Hue] item is for NTSC only

Reducing Picture Noise

- 1 Press **MENU** to display the menu main page.
The [Video] menu page will be selected automatically.
- 2 Press **CH**▼ repeatedly to select the **DNR** item.
- 3 Press **VOL+** or **ENTER** to access the sub-menu.
- 4 Press **CH**▲/▼ to select.
- 5 Press **ENTER** to confirm and press **MENU** repeatedly to exit.
Sometimes a noisy picture may appear on the screen because of poor signal. This function helps to enhance the picture quality by reducing the noise.

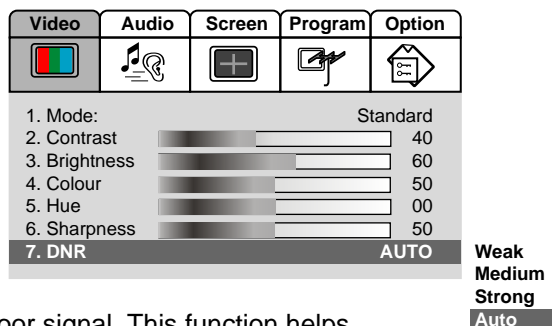

Freezing picture

Press the **FREEZE** button to hold on the image on the screen (the video sources still run). Press again to reactivate the image.

Note:

For the sake of protecting the screen, please do **NOT** freeze a picture for a long time.



Adjusting the Volume

You may quickly adjust the volume by using **VOL+** or **VOL-**. The unit also allows you to adjust volume through OSD menu as follows.

- 1 Press **MENU** to display the menu main page.
- 2 Press **VOL+/-** repeatedly to display **Audio** menu page.
- 3 Press **CH** ▾ to select **Volume** item.
- 4 Press **VOL+/-** to adjust the volume.
- 5 Press **MENU** to exit.

Video	Audio	Screen	Program	Option
1. Volume <input type="text" value="20"/>				
2. Balance <input type="text" value="00"/>				
3. Equalizer: Rock				
4. 120 Hz <input type="text" value="65"/>				
5. 500 Hz <input type="text" value="55"/>				
6. 1.5 KHz <input type="text" value="55"/>				
7. 5 KHz <input type="text" value="55"/>				
8. 10 KHz <input type="text" value="55"/>				
9. HP Volume <input type="text" value="20"/>				
0. SRS Mode: On				

Adjusting the Sound Balance

- 1 Press **MENU** to display the menu main page.
- 2 Press **VOL+/-** repeatedly to display **Audio** menu page.
- 3 Press **CH** ▾ to select **Balance** item.
- 4 Press **VOL+** to decrease the left speaker volume
Press **VOL-** to decrease the right speaker volume.
- 5 Press **MENU** to exit.

Video	Audio	Screen	Program	Option
1. Volume <input type="text" value="20"/>				
2. Balance <input type="text" value="00"/>				
3. Equalizer: Rock				
4. 120 Hz <input type="text" value="65"/>				
5. 500 Hz <input type="text" value="55"/>				
6. 1.5 KHz <input type="text" value="55"/>				
7. 5 KHz <input type="text" value="55"/>				
8. 10 KHz <input type="text" value="55"/>				
9. HP Volume <input type="text" value="20"/>				
0. SRS Mode: On				

Adjusting the Headphone Volume

- 1 Press **MENU** to display the menu main page.
- 2 Press **VOL+/-** repeatedly to display **Audio** menu page.
- 3 Press **CH** ▾ to select **HP Volume** item.
- 4 Press **VOL+/-** to adjust the headphone volume.
- 5 Press **MENU** to exit.

Video	Audio	Screen	Program	Option
1. Volume <input type="text" value="20"/>				
2. Balance <input type="text" value="00"/>				
3. Equalizer: Rock				
4. 120 Hz <input type="text" value="65"/>				
5. 500 Hz <input type="text" value="55"/>				
6. 1.5 KHz <input type="text" value="55"/>				
7. 5 KHz <input type="text" value="55"/>				
8. 10 KHz <input type="text" value="55"/>				
9. HP Volume <input type="text" value="20"/>				
0. SRS Mode: On				

Adjusting Equalizer

The unit provides a Five-Band Equalizer for you to enjoy a high-quality sound. You may select the three preset sound effects according to different situations or customise the sound effect by yourself.

- 1 Press **MENU** to display the menu main page.
- 2 Press **VOL+/-** repeatedly to display **Audio** menu page.
- 3 Press **CH** ▾ to select **Equalizer** item.
- 4 Press **VOL+** or **ENTER** to access the sub-menu.
- 5 Press **CH** ▲/▾ to select.
There are three preset sound effects (**Live**, **Pop** and **Rock**) for your choice according to different situations or you may customise the sound effect as follows.
- 6 Press **ENTER** to confirm.
- 7 Press **CH** ▲/▾ repeatedly to select **120Hz**, **500Hz**, **1.5KHz**, **5KHz** or **10KHz**.
- 8 Press **VOL+/-** to adjust according to your preference.
- 9 Press **MENU** to exit.

Note:

You may quickly select the preset sound effects by using the **S.M** button.

Video	Audio	Screen	Program	Option
1. Volume <input type="text" value="20"/>				
2. Balance <input type="text" value="00"/>				
3. Equalizer: Rock				
4. 120 Hz <input type="text" value="65"/>				
5. 500 Hz <input type="text" value="55"/>				
6. 1.5 KHz <input type="text" value="55"/>				
7. 5 KHz <input type="text" value="55"/>				
8. 10 KHz <input type="text" value="55"/>				
9. HP Volume <input type="text" value="20"/>				
0. SRS Mode: On				

Video	Audio	Screen	Program	Option
1. Volume <input type="text" value="20"/>				
2. Balance <input type="text" value="00"/>				
3. Equalizer: Rock				
4. 120 Hz <input type="text" value="65"/>				
5. 500 Hz <input type="text" value="55"/>				
6. 1.5 KHz <input type="text" value="55"/>				
7. 5 KHz <input type="text" value="55"/>				
8. 10 KHz <input type="text" value="55"/>				
9. HP Volume <input type="text" value="20"/>				
0. SRS Mode: On				

Setting Sound (continued)

Setting SRS effect

- 1 Press **MENU** to display the menu main page.
- 2 Press **VOL+/-** repeatedly to display **Audio** menu page.
- 3 Press **CH▼** to select **SRS Mode** item.
- 4 Press **VOL+** or **ENTER** to access the sub-menu.
- 5 Press **CH▲/▼** to select **On** or **Off**.
- 6 Press **ENTER** to confirm and press **MENU** repeatedly to exit.

Video	Audio	Screen	Program	Option
1. Volume				20
2. Balance				00
3. Equalizer:				Rock
4. 120 Hz				65
5. 500 Hz				55
6. 1.5 KHz				55
7. 5 KHz				55
8. 10 KHz				55
9. HP Volume				20
0. SRS Mode:				On

Off
On

SRS (Sound Retrieval System®) is an audio enhancement technology that restores the spatial cues that are present in a live listening environment and processes it to provide a natural 3D sound field.

* The SRS symbol are trademark of SRS Labs, Inc.
SRS technology is incorporated under license from SRS Labs, Inc.

Note:

If the [SRS] function is turned on, the [Balance] item can be accessed and the **Balance** function becomes invalid. Only under MONO condition does the [SRS] function work.

Stereo/Bilingual Selection

You can quickly select sound multiplex mode by using the **STEREO** button on the remote control.

● NICAM Broadcast Selection

This enables the selection of the reception mode when receiving a NICAM signal. To let you enjoy NICAM broadcasting, this TV set receives NICAM system stereo, bilingual, and monaural broadcasts.

Stereo

When the TV set is receiving a stereo broadcast, press the **STEREO** button to select **NICAM Stereo** or **FORCE Mono**. When **Force Mono** is selected, the TV sound is output monaurally.

Bilingual

When the TV set is receiving a bilingual program, press the **STEREO** button to select **NICAM Dual1**, **NICAM Dual2** or **Force Mono**.

● IGR (German stereo system) Broadcasts

This enables the selection of the reception mode when receiving an IGR signal. To let you enjoy IGR broadcasting, this TV set receives IGR system stereo and bilingual broadcasts.

Stereo

When the TV set is receiving a stereo broadcast, press the **STEREO** button to select **FM/AM Stereo** or **Force Mono**. When **Force Mono** is selected, the TV sound is output monaurally.

Bilingual

When the TV set is receiving bilingual program, press the **STEREO** button to select **FM/AM Dual1** or **FM/AM Dual2**.

Note:

When there is no input signal, the unit mutes the sound automatically, the [Audio] menu page can not be accessed and all operations correlative with audio will be denied.

Setting Colour System

- 1 Press **MENU** to display the menu main page.
- 2 Press **VOL+/-** to display **Program** menu page.
- 3 Press **CH** ▾ repeatedly to select **Colour System** item.
- 4 Press **VOL+** or **ENTER** to access the sub-menu.
- 5 Press **CH** ▲ / ▾ to select a proper colour system.
- 6 Press **ENTER** to confirm and press **MENU** repeatedly to exit.

Video	Audio	Screen	Program	Option
1. Program No:				05
2. Program Name:				
3. Locked:				Off
4. Skip:				Off
5. Favourite:				Off
6. Fine Tuning				50
7. Colour System:				PAL
8. Sound System:				B/G
9. Auto Search				
0. Manual Search				

AUTO
PAL
SECAM

Setting Sound System

- 1 Press **MENU** to display the menu main page.
- 2 Press **VOL+/-** to display **Program** menu page.
- 3 Press **CH** ▾ repeatedly to select **Sound System** item.
- 4 Press **VOL+** or **ENTER** to access the sub-menu.
- 5 Press **CH** ▲ / ▾ to select a proper sound system.
- 6 Press **ENTER** to confirm and press **MENU** repeatedly to exit.

Video	Audio	Screen	Program	Option
1. Program No:				05
2. Program Name:				
3. Locked:				Off
4. Skip:				Off
5. Favourite:				Off
6. Fine Tuning				50
7. Colour System:				PAL
8. Sound System:				B/G
9. Auto Search				
0. Manual Search				

D/K
B/G
I
M/N
L
L'

Changing Screen Aspect Ratio

- 1 Press **MENU** to display the menu main page.
- 2 Press **VOL+/-** repeatedly to display **Option** menu page.
- 3 Press **CH** ▾ repeatedly to select **Display Mode** item.
- 4 Press **VOL+** or **ENTER** to access the sub-menu.
- 5 Press **CH** ▲ / ▾ to select a desired screen ratio.
- 6 Press **ENTER** to confirm and press **MENU** repeatedly to exit.

Video	Audio	Screen	Program	Option
1. Main Display Source:				TV
2. Display Mode:				16:9 Mode
3. PIP Mode:				Off
4. MultiWin Mode:				Off
5. Child Lock:				Off
6. Change Password				
7. Menu Language:				English
8. Country:				Others...
9. Menu Background:				Transparent
0. Blue Screen:				On

Auto
16:9 Mode
4:3 Mode

You can select the screen aspect ratio between **Auto**, **16:9 Mode** and **4:3 Mode**.

Auto --- For the signal input from SCART interface which format can be identified by the unit.

4:3 --- For 4:3 signal format. This mode displays a 4:3 picture at its standard 4:3 size without any stretching.

16:9 --- For 16:9 signal format. This mode displays a 16:9 aspect ratio picture.

System Setting (continued)

Selecting Menu Language

- 1 Press **MENU** to display the menu main page.
- 2 Press **VOL+/-** repeatedly to display **Option** menu page.
- 3 Press **CH**▼ repeatedly to select **Menu Language** item.
- 4 Press **VOL+** or **ENTER** to access the sub-menu.
- 5 Press **CH**▲/▼ to select a desired menu language.
- 6 Press **ENTER** to confirm and press **MENU** repeatedly to exit.

Video	Audio	Screen	Program	Option
1. Main Display Source:				TV
2. Display Mode:				16:9 Mode
3. PIP Mode:				Off
4. MultiWin Mode:				Off
5. Child Lock:				Off
6. Change Password				
7. Menu Language:				English
8. Country:				Others...
9. Menu Background:				Transparent
0. Blue Screen:				On

Trad-Chinese
English

Setting Menu Background

- 1 Press **MENU** to display the menu main page.
- 2 Press **VOL+/-** repeatedly to display **Option** menu page.
- 3 Press **CH**▼ repeatedly to select **Menu Background** item.
- 4 Press **VOL+** or **ENTER** to access the sub-menu.
- 5 Press **CH**▲/▼ to select **Transparent** or **Opaque**.
- 6 Press **ENTER** to confirm and press **MENU** repeatedly to exit.

Video	Audio	Screen	Program	Option
1. Main Display Source:				TV
2. Display Mode:				16:9 Mode
3. PIP Mode:				Off
4. MultiWin Mode:				Off
5. Child Lock:				Off
6. Change Password				
7. Menu Language:				English
8. Country:				Others...
9. Menu Background:				Transparent
0. Blue Screen:				On

Opaque
Transparent

Setting Blue Screen

- 1 Press **MENU** to display the menu main page.
- 2 Press **VOL+/-** repeatedly to display **Option** menu page.
- 3 Press **CH**▼ repeatedly to select **Blue Screen** item.
- 4 Press **VOL+** or **ENTER** to access the sub-menu.
- 5 Press **CH**▲/▼ to select **On** or **Off**.
- 6 Press **ENTER** to confirm and press **MENU** repeatedly to exit.

Video	Audio	Screen	Program	Option
1. Main Display Source:				TV
2. Display Mode:				16:9 Mode
3. PIP Mode:				Off
4. MultiWin Mode:				Off
5. Child Lock:				Off
6. Change Password				
7. Menu Language:				English
8. Country:				Others...
9. Menu Background:				Transparent
0. Blue Screen:				On

Off
On

If the [Blue Screen] is set to [On], the unit displays a blue background when there is no input signal. In TV mode, when there is no input signal for approx. 5 minutes, the TV set auto goes to STANDBY mode.

Setting Sleep Timer

You can quickly set the sleep timer by using the SLP button on the remote control. With every press of this button the sleep time changes as follows:

Cancel → 15 Min. → 30 Min. → 45 Min. → 60 Min. → 90 Min. → 120 Min.

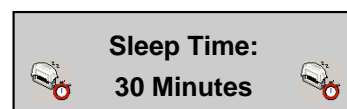
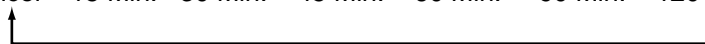

Setting Current Time/Turn Off Timer/Turn On Timer

With the unit working, press **TIMER** to display **Current Time** setting menu, which allows you to set Current Time. You may use **VOL+/-** to toggle hour or minute and **CH**▲/▼ to adjust.

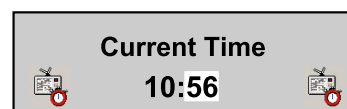

With the **Current Time** menu on the screen, press **TIMER** again to display **Turn Off Time** setting menu, which allows you to set **Turn Off Time**. You may use **VOL+/-** to toggle hour or minute and **CH**▲/▼ to adjust.



With the **Turn Off Time** menu on the screen, press **TIMER** again to display **Turn On Time** setting menu, which allows you to set **Turn On Time**. You may use **VOL+/-** to toggle hour or minute and **CH**▲/▼ to adjust.

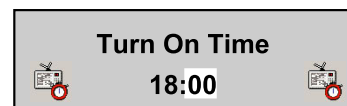

Note:

If you want to cancel the Off-Timer or On-Timer function, please set the [Turn Off Timer or [Turn On Time] to [00:00].

Selecting Screen Layout

- 1 Press **MENU** to display the menu main page.
- 2 Press **VOL+/-** repeatedly to display **Option** menu page.
- 3 Press **CH ▾** repeatedly to select **MultiWin Mode** item.
- 4 Press **VOL+** or **ENTER** to access the sub-menu.
- 5 Press **CH ▲/▾** to select **Off**, **POP**, **6 Windows** or **9 Windows**.
- 6 Press **ENTER** to confirm and press **MENU** repeatedly to exit.

Video	Audio	Screen	Program	Option
1. Main Display Source:				TV
2. Display Mode:				16:9 Mode
3. PIP Mode:				Off
4. MultiWin Mode:				POP
5. Child Lock:				Off
6. Change Password				
7. Menu Language:				English
8. Country:				Others...
9. Menu Background:				Transparent
0. Blue Screen:				On

Off

POP

6 Windows

9 Windows

Note:

- You may quickly select screen layout by using the **M.WIN** button.
- When viewing TV program in full screen, the features of [POP], [6 Windows] and [9 Windows] can be accessed;
- When viewing Video or S-Video input, the features of [POP] and [6 Windows] can be accessed;
- When viewing SCART, YCbCr/YPbPr, D-Sub or DVI input, the features of [POP], [6 Windows] and [9 Windows] can not be accessed.

POP (Picture-out-Picture)

The **POP** (picture-out-picture) feature splits the screen into a double window that allows you to watch two programs at the same time. The main window program can come from a TV broadcast, Video or S-Video input, while the POP window always displays TV program.

Note:

You may use the **POP** button to quickly turn on or off the POP feature.

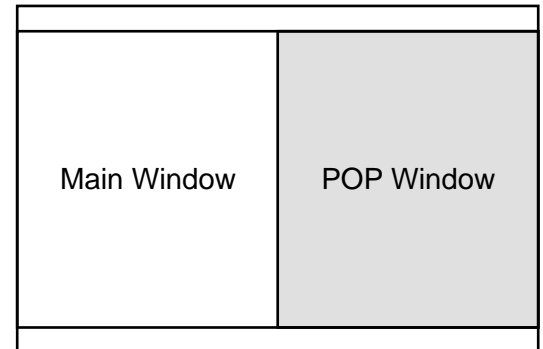

6 Windows

When this item is selected, one main window and five scanning windows display on the screen. The main window program can come from a TV broadcast, Video or S-Video input.

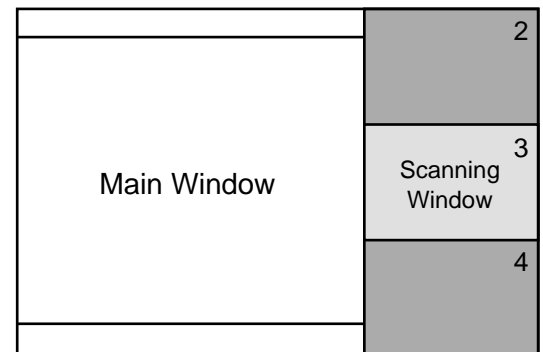

9 Windows

When this item is selected, the screen displays 9 scanning windows. This function enables you to quickly browse all active channel.

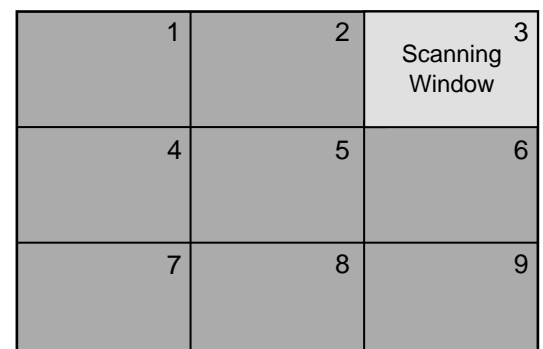

PIP Operations

Viewing the Picture-in-Picture

This unit includes a two-tuner Picture-in-Picture (PIP) feature. This allows you to watch two live broadcasts simultaneously, one in the full size "main" picture and one in a smaller "window" picture. The main window program can come from a TV broadcast or other external source, while the PIP window always displays TV program.

- 1 With the unit working in single full screen, press **MENU** to display the menu main page.
- 2 Press **VOL+/-** repeatedly to display **Option** menu page.
- 3 Press **CH ▾** repeatedly to select **PIP Mode** item.
- 4 Press **VOL+** or **ENTER** to access the sub-menu.
- 5 Press **CH ▲/▾** to select **Off**, **Up-Left**, **Up-Right**, **Down-Right**, **Down-Left** or **Centre**.
 - Off** -Turn off PIP feature.
 - Up-Left** -Turn on PIP feature and display the PIP window on up-left corner of the screen.
 - Up-Right** -Turn on PIP feature and display the PIP window on up-right corner of the screen.
 - Down-Right** -Turn on PIP feature and display the PIP window on down-right corner of the screen.
 - Down-Left** - Turn on PIP feature and display the PIP window on down-left corner of the screen.
 - Centre** -Turn on PIP feature and display the PIP window on centre of the screen.

Video	Audio	Screen	Program	Option
1. Main Display Source:				TV
2. Display Mode:				16:9 Mode
3. PIP Mode:				Down-Left
4. MultiWin Mode:				POP
5. Child Lock:				Off
6. Change Password				
7. Menu Language:				English
8. Country:				Other ...
9. Menu Background:				Transparent
0. Blue Screen:				On

- Off
- Up-Left
- Up-Right
- Down-Right
- Down-Left**
- Center

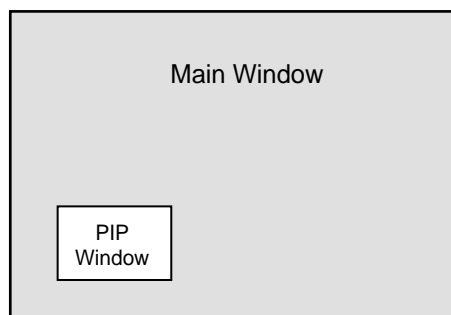

- 6 Press **ENTER** to confirm and press **MENU** repeatedly to exit.

Note:

You may use the **PIP** button to quickly turn on or off the PIP feature.

Using the PIP-POS button

Press the **PIP-POS** button to quickly select the position for PIP window.

Using the Active-WIN button

Press this button to select either the main window or PIP window in order to perform some operations for the PIP window individually. The selected PIP window displays with a red border. The unit allows you to apply many operations to the PIP picture such as adjusting volume, changing channels, adjusting picture, locking channels, setting favourite channels.

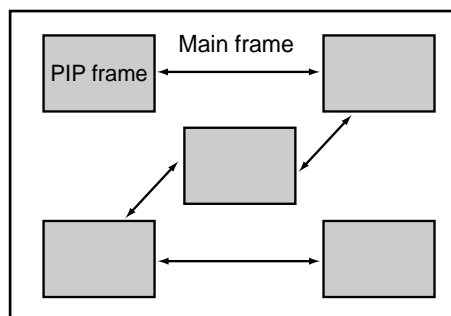

Note:

- ▶ Many but not all adjustments and settings can be applied to the PIP window when the PIP window is selected.
- ▶ The PIP audio is only output through the headphone jack.

Swap the Contents of the PIP Image and Main Image

- 1 Press the **PIP** button to display the PIP window.
- 2 Press the **SWAP** button to swap the contents of the PIP window and main window.

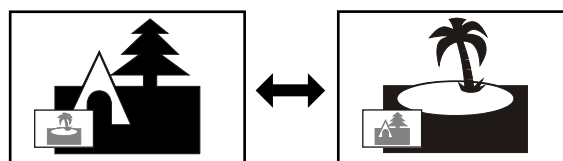

Note:





The Swap function does not work unless the signal source of the main window is set to TV Mode.

Adjustment in D-Sub/DVI Mode

With working in D-Sub or DVI mode, this unit allows you to perform many adjustments.

Adjusting Image Horizontal Size





- 1 Press **MENU** to display the menu main page.
- 2 Press **VOL+/-** repeatedly to display **Screen** menu page.
- 3 Press **CH ▾** to select **H Size** item.
- 4 Press **VOL+/-** to adjust until you are satisfied.
- 5 Press **MENU** to exit.

Video	Audio	Screen	Program	Option
				
1. H Size				0
2. H Position				0
3. V Position				0
4. Fine Tune				00
5. Smoothing Mode:				Both off
6. Default				
7. Auto Sync				
8. Advanced:				>>>

Changing the Position of Image





After connecting the unit to your PC, adjust the position of the screen if it is not well-aligned.

- 1 Press **MENU** to display the menu main page.
- 2 Press **VOL+/-** repeatedly to display **Screen** menu page.
- 3 Press **CH ▾** to enter the menu and press **CH ▲** or **CH ▾** to select **H Position** or **V Position**.
- 4 Press **VOL+/-** to adjust until the picture is well-aligned.
- 5 Press **MENU** to exit.

Video	Audio	Screen	Program	Option
				
1. H Size				0
2. H Position				0
3. V Position				0
4. Fine Tune				00
5. Smoothing Mode:				Both off
6. Default				
7. Auto Sync				
8. Advanced:				>>>

Fine Tune

- 1 Press **MENU** to display the menu main page.
- 2 Press **VOL+/-** repeatedly to display **Screen** menu page.
- 3 Press **CH ▾** repeatedly to select **Fine Tune**.
- 4 Press **VOL+/-** to adjust until the picture is well-aligned.
- 5 Press **MENU** to exit.

Video	Audio	Screen	Program	Option
				
1. H Size				0
2. H Position				0
3. V Position				0
4. Fine Tune				10
5. Smoothing Mode:				Both off
6. Default				
7. Auto Sync				
8. Advanced:				>>>

You may find that images blur, depending on the clock phase of your PC's Processor. If you experience blurring, you can obtain a clearer image by adjusting the [Fine Tune] item.

Note:

The [Fine Tune] item can not be accessed in DVI mode.

Adjusting the Screen Automatically





- 1 Press **MENU** to display the menu main page.
- 2 Press **VOL+/-** repeatedly to display **Screen** menu page.
- 3 Press **CH ▾** repeatedly to select **Auto Sync** item.
- 4 Press **ENTER** to confirm and press **MENU** repeatedly to exit.

You may quickly adjust the screen by using the **STEREO** button directly. The unit automatically adjusts phase, clock or position, etc.

Note:

The [Auto Sync] item can not be accessed unless the unit is in VGA mode.

The "Auto Adjust" function only works in VGA mode.

Video	Audio	Screen	Program	Option
				
1. H Size				0
2. H Position				0
3. V Position				0
4. Fine Tune				00
5. Smoothing Mode:				Both off
6. Default				
7. Auto Sync				
8. Advanced:				>>>

Adjustment in D-Sub/DVI Mode (Continued)

Smoothing the Picture

- 1 Press **MENU** to display the menu main page.
- 2 Press **VOL+/-** repeatedly to display **Screen** menu page.
- 3 Press **CH** ▾ repeatedly to select **Smoothing Mode** item.
- 4 Press **VOL+** or **ENTER** to access the sub-menu.
- 5 Press **CH** ▲/▾ to select **Both on**, **Only Ver. on**, **Only Hor. on** or **Both off**.
- 6 Press **ENTER** to confirm and press **MENU** repeatedly to exit.

Video	Audio	Screen	Program	Option
1. H Size		<input type="text"/>		0
2. H Position		<input type="text"/>		0
3. V Position		<input type="text"/>		0
4. Fine Tune		<input type="text"/>		00
5. Smoothing Mode:				Both off
6. Default				
7. Auto Sync				
8. Advanced:				>>>

Both on
Only Ver. on
Only Hor. on
Both off

When the screen displays a picture with a bevel edge, you may find a sawtooth picture on the bevel edge. This function helps to improve the picture quality by smoothing the sawtooth picture.

- Both on - Smooth picture in the horizontal and vertical directions;
- Only Ver. on - Smooth picture in the vertical direction;
- Only Hor. on - Smooth picture in the horizontal direction;
- Both off - Turn off this function.

Loading Default Values

- 1 Press **MENU** to display the menu main page.
- 2 Press **VOL+/-** repeatedly to display **Screen** menu page.
- 3 Press **CH** ▾ repeatedly to select **Default** item.
- 4 Press **ENTER** to confirm and press **MENU** repeatedly to exit.

Video	Audio	Screen	Program	Option
1. H Size		<input type="text"/>		0
2. H Position		<input type="text"/>		0
3. V Position		<input type="text"/>		0
4. Fine Tune		<input type="text"/>		00
5. Smoothing Mode:				Both off
6. Default				
7. Auto Sync				
8. Advanced:				>>>

Advanced Adjustment for Image Position

It is unnecessary to perform advanced adjustment in normal case. In most cases, the [Auto Sync] function is able to adjust and rectify the picture automatically. But, sometimes, if you find that the image position can not be correctly displayed even if you have adjusted the [H Position], [V Position] or [Auto Sync] item, please try to perform advanced adjustment for the image position.

- 1 Press **MENU** to display the menu main page.
- 2 Press **VOL+/-** repeatedly to display **Screen** menu page.
- 3 Press **CH** ▾ repeatedly to select **Advanced** item.
- 4 Press **VOL+** or **ENTER** to access the sub-menu.
- 5 Press **CH** ▲/▾ to select **H Position** or **V Position** item.
- 6 Press **VOL+/-** to adjust the image position.
- 7 Press **ENTER** to confirm and press **MENU** repeatedly to exit.

Video	Audio	Screen	Program	Option
1. H Size		<input type="text"/>		0
2. H Position		<input type="text"/>		0
3. V Position		<input type="text"/>		0
4. Fine Tune		<input type="text"/>		00
5. Smoothing Mode:				Both off
6. Default				
7. Auto Sync				
8. Advanced::				>>>

Video	Audio	Screen	Program	Option
1. H Position		<input type="text"/>		0
2. V Position		<input type="text"/>		0

What Is Teletext?

Teletext broadcasts pages of information and entertainment to specially equipped television sets. Your System receives Teletext signals broadcast by a TV network, and decodes them into graphical format for viewing. News, weather and sports information, stock exchange prices and programme previews are among the many services available.

Teletext Mode

Teletext is turned on/off with the **TEXT** button on the remote control unit. You can operate your System in Teletext mode directly by inputting commands with the remote control unit.

Turning On or Off Teletext

Select a TV channel providing the Teletext program.
Press the **TEXT** button to display the Teletext with black background.
Press the **TEXT** button again to switch back to TV screen.

Button Functions

CH ▲ or CH ▼

Changing Teletext pages.

VOL+ or VOL-

Adjusting volume.

MUTE

Muting the sound.

Colour (RED/GREEN/YELLOW/BLUE)

You can select a group or block of pages displayed in the coloured brackets at the bottom of the screen by pressing the corresponding colour (RED/GREEN/YELLOW/BLUE) on the remote control unit.

0-9

Directly select any page by using 0-9.

MIX

Press this button to display the Teletext on the screen with transparent background while viewing the TV program simultaneously.

REVEAL

Press the button to reveal hidden information such as an answer to a quiz. Press the button again to hide the information.

SIZE

Press the button to expand the top half of the display. Press it again to expand the bottom half of the display. Press it once more to resume normal size.

HOLD

Press the button to stop updating Teletext pages automatically. Press it again to release hold mode.

UPDATE

Press the button to view the updated teletext page.

Display the TV picture on the screen while waiting for the new teletext page. The characters "???" will appear at the top of left corner of the screen. Then you can input a desired page number. When the update page is available, then the characters "???" will change to the page number.

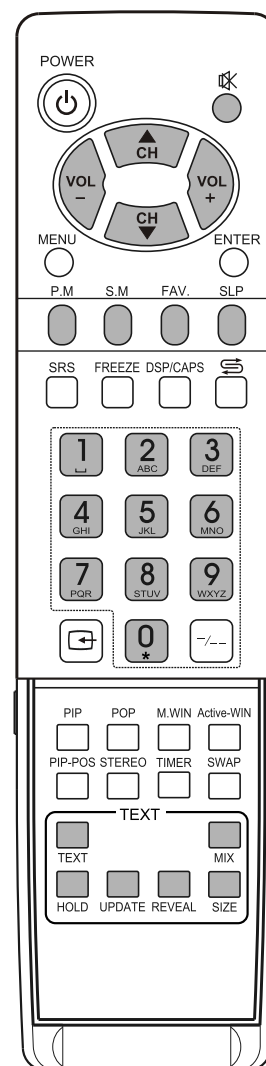

Troubleshooting

Before calling for repair service, check the following items for possible remedies to an encountered symptom.

Symptoms	Check item
"Ghost" or double images	<ul style="list-style-type: none"> • This may be caused by obstruction to the antenna due to high rise buildings or hills. Using a highly directional antenna may improve the picture.
No power	<ul style="list-style-type: none"> • Check that the AC power cord is plugged into the mains socket. • Unplug the power cord, wait for 60 seconds. Then reinsert plug into the mains socket and turn on the unit again.
No picture	<ul style="list-style-type: none"> • Check antenna connections at the rear of the unit to see if it is properly connected to the unit. • Possible broadcast station trouble. Try another channel. • Adjust the contrast and brightness settings. • Select a correct input. • Is a non-compatible signal being input?
Good picture but no sound	<ul style="list-style-type: none"> • Increase the VOLUME. • Check that the unit is not muted.
Good sound but poor colour	<ul style="list-style-type: none"> • Adjust the contrast, colour and brightness settings.
Poor picture	<ul style="list-style-type: none"> • Sometimes, poor picture quality occurs when having activated an S-VHS camera or camcorder connected and having connected another peripheral at the same time. In this case, switch off one of the other peripherals. • Check whether the room is too bright.
Horizontal dotted line	<ul style="list-style-type: none"> • This may be caused by electrical interference (e.g. hair dryer, nearby neon lights, etc.) • Turn off the equipment.
Television not responding to remote control	<ul style="list-style-type: none"> • Check whether the batteries are working. Replace if necessary. • Clean the remote control sensor lens on the unit. • Do not use the remote control under strong or fluorescent lighting. • The batteries should be inserted with polarity (+, -) aligned.
Snowy picture and noise	<ul style="list-style-type: none"> • Check the aerial connection.
No stable or not synchronised D-Sub picture	<ul style="list-style-type: none"> • Check if you have selected the correct D-Sub mode in your PC.
No output from one of the speakers	<ul style="list-style-type: none"> • Adjust Balance in the Audio menu.
Controls buttons do not work	<ul style="list-style-type: none"> • Unplug the power cord, wait for some seconds. Then re-plug the power cord and turn on the unit again.

Do not use in hot and cold rooms (location)

When the unit is used in rooms (locations) with low temperature, the picture may leave trails or appear slightly delayed. This is not a malfunction, and the unit will recover when the temperature returns to normal.

Do not leave the unit in a hot or cold location. Also, do not leave the unit in a location exposed to direct sunlight or near a heater, as this may cause the cabinet to deform and the LCD panel to malfunction.

(Storage temperature: 0°C to +50°C; Working temperature: 5°C to 40°C.)

Note:

If your problem is not solved, restart your TV by turning it off and then on again once.

Never attempt to repair a defective TV yourself.

Specifications

Type	LCD TV		
Display Size diagonal	68CM		
Display Feature			
LCD Panel	TFT-LCD		
Resolution	1280 x 720		
Pixel Pitch	0.51mm x 0.51mm		
Maximum Colours	16,700,000		
Brightness	550 nits		
Contrast	600:1		
Viewing Angle	170 ⁰ /170 ⁰		
Response Time	16.6ms (Typ.)		
TV System	PAL/SECAM BG, DK, PAL-I, SECAM-L, SECAM-L', NTSC (AV)		
Channel Coverage			
System	VHF	UHF	CATV
PAL-D/K	1-12	13-57	Z1~Z37
PAL-B/G	2-12	21-69	X~Z+2, S1~S41
PAL-I	2-12	21-69	
SECAM-B/G	2-12	21-69	X~Z+2, S1~S41
SECAM-D/K	1-12	21-69	
SECAM-L'	2-4		
SECAM-L	5-12	21-69	X~ZC57, S1~S41
Teletext	TOP/FLOF TELETEXT		
Maximum Audio Output	7W x 2		
Power Supply	100-240V AC 50/60Hz		
Power Consumption	140 W		
Unit Weight (kg)	19		
Unit Dimensions (WxHxD) (mm)	808.5 x 524 x 232		
Terminals			
Video In	RF: TV/CATV 75ohms coaxial x 1		
	D-Sub x 1, DVI-D x 1		
	YPbPr/YCbCr (support HDTV): RCA 75 ohms x 1		
	Video RCA 75ohms x 1		
	S-Video x 1		
Audio In	3.5mm Stereo mini phone jack for D-Sub x 1		
	3.5mm Stereo min phone for DVI-D x 1		
	L/R RCA for YPbPr/YCbCr x 1		
	L/R RCA for Video In x 2		
Video Out	Video RCA 75ohms x 1		
Audio Out	L/R RCA for Video Out x 1		
Other	Headphone: 3.5mm Stereo mini phone jack		

Specifications (continued)

Supported Display Format:

D-Sub/DVI-D: 1024 x 768 @ 75Hz, 70Hz, 60Hz
720 x 400 @ 70Hz

800 x 600 @ 75Hz, 72Hz, 60Hz
640 x 480 @ 75Hz, 60Hz

YPbPr: 480P @ 60Hz
576P @ 50Hz
720P @ 50Hz, 60Hz
1080i @ 50Hz, 60Hz

480i @ 60Hz
576i @ 50Hz

Accessories

Standard Accessories: 1 User Manual
1 AC Power Cord
1 Remote Control
2 AAA Batteries
1 Audio/Video Cable (RCA)
1 D-Sub Cable
1 RF Coaxial Cable
1 S-Video Cable
1 Component-Video Cable (YPbPr/YCbCr)
1 Audio Cable (RCA to Stereo mini phone Jack)

Design and specification are subject to change without notice.

PALSONIC CORPORATION PTY LTD
1 JOYNTON AVENUE
WATERLOO NSW 2017 AUSTRALIA
TEL: (02) 9313 7111
FAX: (02) 9313 7555
www.palsonic.com.au

**PALSONIC CUSTOMER SERVICE
TELEPHONE
AUSTRALIA: 1300 657 888**

604-L27M6S3-19
V1.1

Free Manuals Download Website

<http://myh66.com>

<http://usermanuals.us>

<http://www.somanuals.com>

<http://www.4manuals.cc>

<http://www.manual-lib.com>

<http://www.404manual.com>

<http://www.luxmanual.com>

<http://aubethermostatmanual.com>

Golf course search by state

<http://golfingnear.com>

Email search by domain

<http://emailbydomain.com>

Auto manuals search

<http://auto.somanuals.com>

TV manuals search

<http://tv.somanuals.com>