

Palsonic



DVD4000 DVD USERS GUIDE



CAUTION:
To reduce the risk of fire and electric shock,
do not remove the cover of the unit. Refer
servicing only to qualified personnel.

PALSONIC CORPORATION PTY LTD
1 JOYNTON AVENUE
WATERLOO NSW 2017 AUSTRALIA
TEL:(02)9313 7111
FAX:(02)9313 7555
www.palsonic.com.au

**PALSONIC CUSTOMER SERVICE
TELEPHONE
AUSTRALIA:1300 657 888**

Contents

DVD Player Features	1	On-Screen Messages	26
Safety	2	Playback Displays	26
Warning	2	System Setup	27
Important Notice		Menu Operation	27
Player Overview	3	General Setup Menu	28
Front Panel	3	Speaker Setup	29
Rear Panel	3	Audio Out Setup	30
Remote Control	4	Preferences Setup	31
Front Panel Display	5	Troubleshooting	32
Getting Started	6	Specifications	32
Accessories	6	Additional Information	33
Remote Control Operation	6	Disc Care	34
System Connections	7	Disc Cleaning	34
Initial Setup	9	Disc Storage	34
Supported Disc Formats	9		
Playback Features	10		
Basic Playback	10		
Playing Desired Title / Chapter / Time	12		
DVD PBC Playback	14		
Special Playback Features	15		
Playing VCDs	21		
Playing Audio CDs	23		
Playing MP3 Files	24		
Viewing Picture CDs	25		

Features





Thank you for choosing the Palsonic DVD4000 DVD Player. We strongly recommend that you carefully study this users guide before attempting to operate the unit and keep it for reference.

Your player provides:

- Composite video, S-video and component video (Y, CB, CR) outputs
- Coaxial and optical audio outputs with Dolby Digital and DTS bitstream
- Stereo audio output
- Hi-end sound quality: 96KHz/24Bit audio digital processor
- Intelligent software upgradability
- Compatible with DVD-Video, Video CD (VCD) Audio CD (CD-DA) and MP3 on CD-R/CD-RW

Safety

TO REDUCE THE RISK OF FIRES AND ELECTRIC SHOCK, DO NOT EXPOSE THIS UNIT TO RAIN OR MOISTURE!

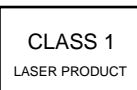
  	CAUTION: To reduce the risk of fire and electric shock do not remove the cover of the unit. Refer servicing only to qualified personnel.
	This lightning flash arrow symbol in a triangle is intended to alert users to the presence of non-insulated high voltage within the product's enclosure that may be of sufficient magnitude to constitute a risk of electric shock to a person.
	The exclamation point symbol in a triangle is intended to alert users to the presence of important operating and maintenance instructions in the literature accompanying the unit.
	CAUTION: INVISIBLE LASER RADIATION WHEN OPEN AND INTERLOCK DEFEATED. AVOID EXPOSURE TO BEAM. Use of controls adjustments or performance of procedures other than those specified herein may result in hazardous radiation.

IMPORTANT NOTICE

REFER SERVICING ONLY TO QUALIFIED SERVICE PERSONNEL

- Read through this instruction manual before installation and use.
- Do not touch the power plug with wet hands.
- When disconnecting the power cord from the power outlet, hold the plug, do not pull the wire.
- Switch off the main power when the unit is not in use. (Disconnect the power plug from the power outlet when you do not intend to use the unit for a prolonged period of time.)
- Before moving the unit, remove the disc from the unit's tray first.
- Do not open the cover or touch any of the components inside the unit.
- Do not install or operate the unit directly exposed to sunlight or nearby objects radiating heat that may lead to overheating and danger to the unit.
- Do not install or operate the unit near moisture or humidity that may affect the laser head.
- Install the unit on flat surface with good air circulation. Do not cover the ventilation holes on the unit in any manner. The unit could possibly overheat and malfunction.
- Wipe the panel and case with soft dry cloth only. Do not apply any kind of thinner, alcohol or sprays when cleaning the unit.

Player Overview

Front Panel

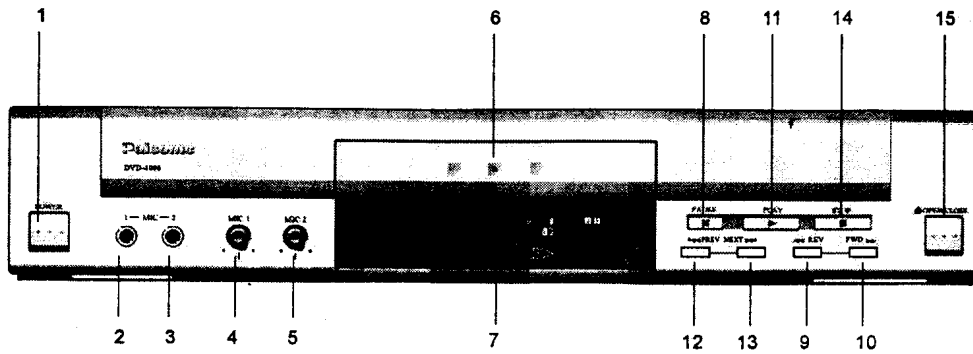

- | | | | |
|----------------------|----------------------|-------------------------|-----------------------|
| 1. Power button | 5. Mic 2 volume knob | 9. Fast backward button | 13. Next Button |
| 2. Microphone 1 Jack | 6. DVD disc tray | 10. Fast forward button | 14. Stop button |
| 3. Microphone 2 Jack | 7. VFD display | 11. Play button | 15. Open/Close button |
| 4. Mic 1 volume knob | 8. Pause button | 12. Previous button | |

Rear Panel

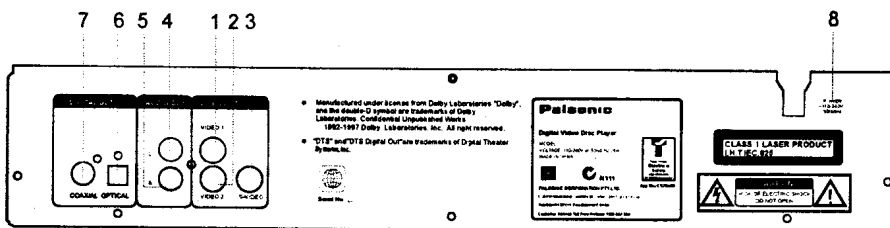

- | | | |
|-----------------------------|-----------------------|---------------------------------|
| 1. Composite video output 1 | 4. Left audio output | 7. Digital audio coaxial output |
| 2. Composite video output 2 | 5. Right audio output | 8. Power cord |
| 3. S-video output | 6. Optical | |

Player Overview

Remote Control:

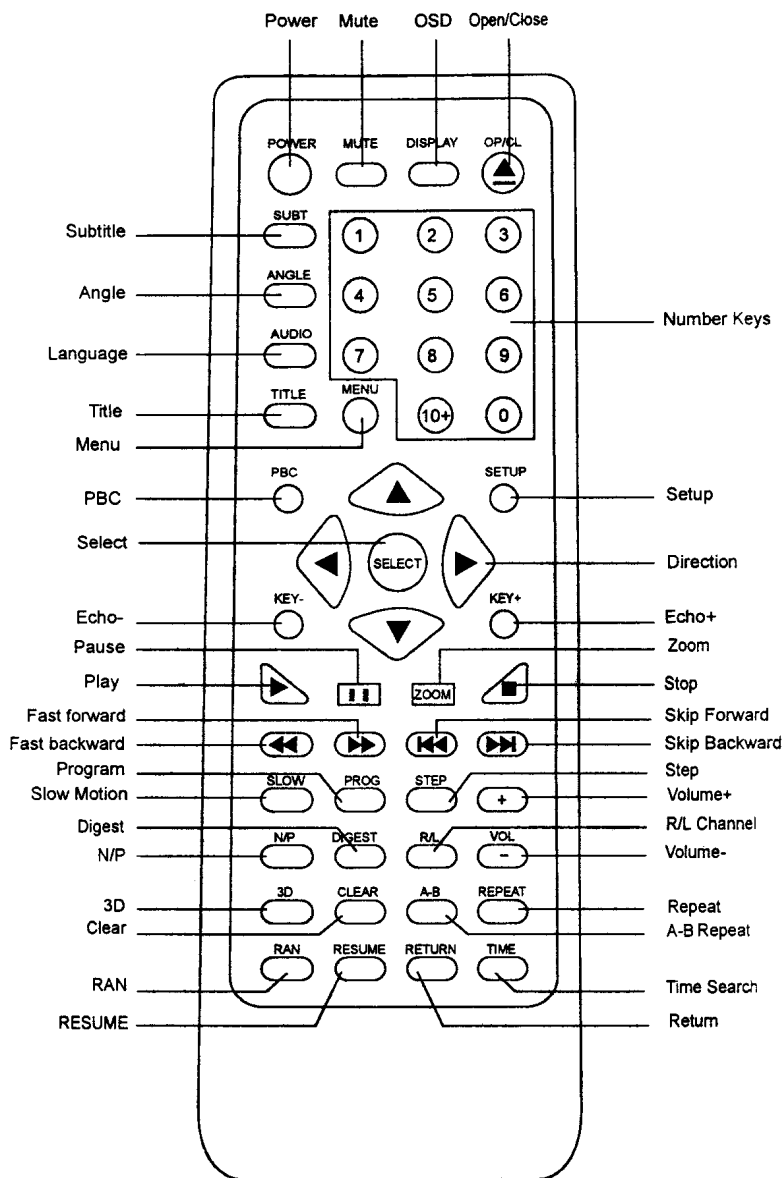

Player Overview

Front Panel Display

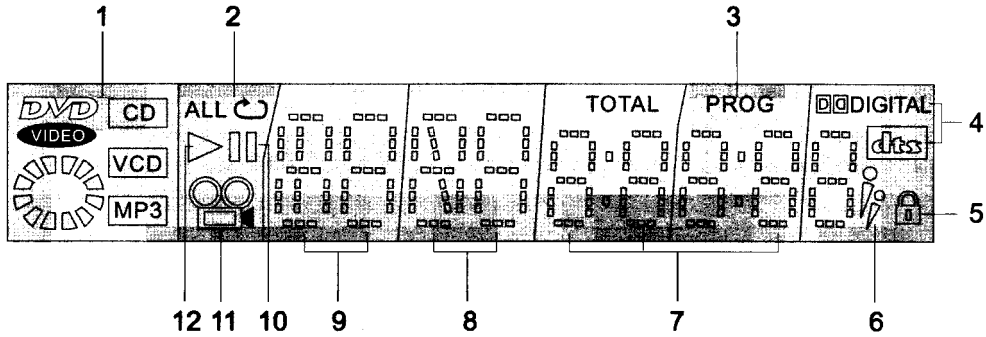

1. Disc Indication
2. Repeat
3. Program.
4. Dolby DiAC-3 & DTS indication
5. DTS lock/unlock
6. Microphone
7. Time indication
8. Chapter indication
9. Title indication
10. Pause
11. Multi-angle
12. Play indication

Getting Started

Accessories

Remote Control1

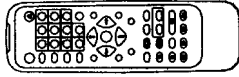

Instruction Manual 1



Audio cable1

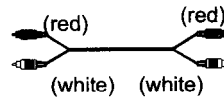

Video cable1

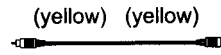

Remote Control Operation

1
Remove Battery Cover

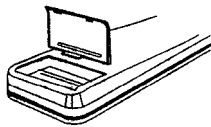

2
Insert Batteries

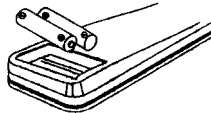

3
Close the battery cover



Care of remote control:

- Aim remote control toward remote sensor of unit.
- Do not drop the unit.
- Store remote in a cool, dry place.
- Do not sprinkle water or other liquid on remote control.
- Do not unpack remote control.

4

Point remote control directly toward the remote sensor.

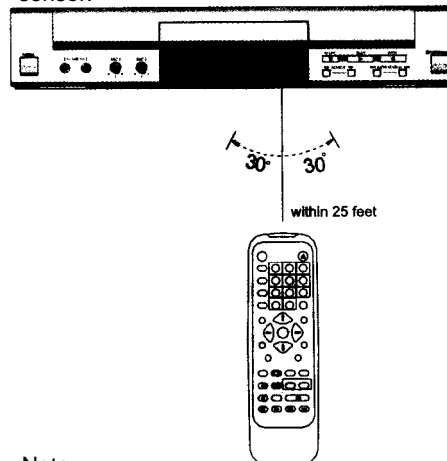

Note:

- Please operate remote control within the distance of 25 feet away from the unit.
- Do not expose remote control sensor directly to the heat source, or it will cause remote control to malfunction.

Getting Started

System Connection:

Video Connection

- The unit supports two choices of video output: composite video and S-video output.

Composite Video Output

- Connect the supplied video cable (yellow) to the video output (yellow) of the unit and to the video input of your TV or monitor.

S-Video Output

- Connect an S-video cable (not included) to the S-video output of the unit and to the S-video input of your TV or monitor.

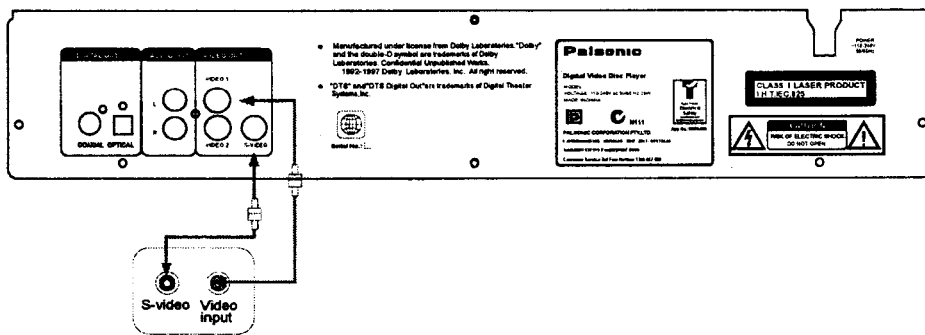

Note:

- Select the type of connection depending on the TV/monitor input.
- Only one video connection type is needed.

Getting Started

System Connection

Audio Connection

- The unit supports two choices of audio output Analog Audio and Digital Audio. Analog Audio is stereo (2 channel). Digital Audio provides optical and coaxial outputs. Digital Audio provides 5.1 channels using an external decoder.

Stereo Output

- Connect the audio cable to the audio out of the unit and to the stereo input of the TV or amplifier.

Coaxial Output

- Connect a coaxial cable to the coaxial output of the unit and to the corresponding digital input of your decoder/amplifier.

Optical output

- Connect an optical cable to the optical output of the unit and to the corresponding digital input of your decoder/amplifier.

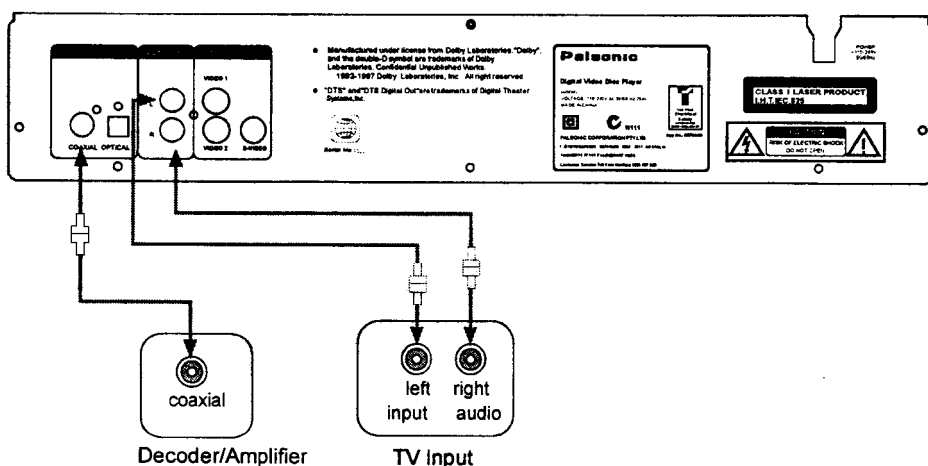

Note:

- Select the type of connection depending on your peripheral equipment.
- If a decoder/amplifier with coaxial or optical inputs is available, you can enjoy DTS and Dolby Digital soundtracks
- Please refer to the instructions of your other equipment, and power off the unit and the other equipment before connecting.

Getting Started

Setup Before Operation









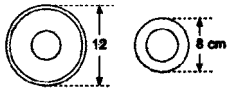

Before operation, please make sure the following setup is correct

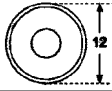
1	Audio Output	The unit has three choices of audio output: 2 channel (Lt/Rt), Stereo PCM, Digital. Select different setup depending on your connection. For more information, please refer to "System Setup (page 30).
2	Video Output	The unit has three choices of video output: Composite video, S-video, and Component video output. Select different setup depending on your connection. For more information, please refer to System Setup

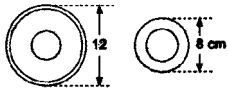
Note:

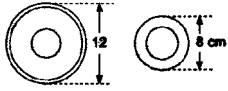

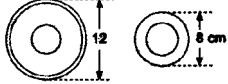
- DVD disc can support different scale of pictures. maybe picture is not full screen or part of picture has been blocked.
- The manual refers to English OSD.

Types of Discs That Can Be Used

Disc	Size	Symbol	Content
DVD			audio+video
MP3			audio
Video CD (VCD)			audio+video
Audio CD (CD-DA)			audio
Kodak picture CD			video

Playback Features

Basic Playback



A Getting Started	
1 Power 	Power on the unit. Press POWER button on front panel. Power indicator will light.
2 Open/Close 	Press Open/Close to open the tray
3	Place disc on the tray with label side up.
4 Open/Close 	Press Open/Close again, the tray will close and begin to play disc.

Note:

- Do not move the unit during operation, or the disc may be damaged.
- Do not touch the tray while it is moving, or the unit may malfunction.
- Do not press the tray or place foreign objects on the tray, or the unit may malfunction.

Playback Features

Basic Playback





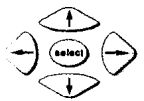
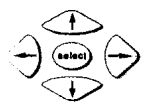

B Changing Discs	
Open/Close 	<p>Press Open/Close Replace the disc after the tray is fully open.</p> <p>Note:</p> <ul style="list-style-type: none">• Press the button again after replacing the disc.• Do not press the button while the unit is loading the disc.
C Stop	
Stop 	<p>Press STOP once to memorize the stopped position. When you press PLAY, the disc will resume play from the stopped position.</p> <p>Press STOP twice to stop and reset the disc. When you press PLAY, the disc will play from the beginning.</p>

Playback Features

Playing the desired title, chapter and time

Usually, DVD discs are divided into titles and titles are divided into chapters.

A Title Menu	If the disc contains multiple titles, it may have a Title menu to access them.				
1 TITLE 	Press TITLE to display the title menu. <table border="1" data-bbox="821 465 1050 638"> <tr> <td>TITLE 1</td> <td>TITLE 2</td> </tr> <tr> <td>TITLE 3</td> <td>TITLE 4</td> </tr> </table>	TITLE 1	TITLE 2	TITLE 3	TITLE 4
TITLE 1	TITLE 2				
TITLE 3	TITLE 4				
2 	Use the arrow keys to select the desired title. You can use the 0-9 keys to select the title if numbers are indicated in the Title menu.				
3 	Press SELECT to start playback from the first chapter of the selected title.				



B Skip Playback	
Skip backward  Skip forward 	Press  or  Press  to skip to the previous chapter. Press  to skip to the next chapter.

Note:

- Some discs do not display the title contents after pressing TITLE.
- The operation may vary according to the DVD disc.

Playback Features

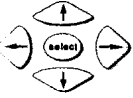
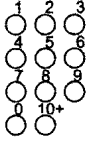
Playing the desired title, chapter and time

C	You can choose your desired title, chapter and time.
1 Search 	Press SEARCH button, displaying: TITLE 01/01 CHAPTER 00/018 For example:
2 	Press the Search button to select Time Search, Chapter Search or Title Search.
3 	Press the 0-9 keys to enter the time (hours, minutes and seconds) or the number of the title or chapter. For Example: Time  1 : 23 : 50
4 Select 	Press SELECT to start playback from the selected time, chapter or title.

Playback Features

DVD PBC Playback

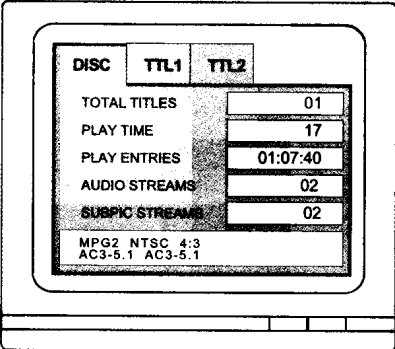







A	You can use an alternative means of disc navigation for DVDs.
<p>Close navigational system</p>	<p>Press PBC button and the screen will display a summary of the disc contents:</p> <div style="text-align: center;">  </div> <p>Press the left/right buttons to select different titles. The relevant information for the selected title will be displayed. Press the SELECT key to play the selected title. You can also press the 0-9 keys to start playback of the desired tile.</p>

B	
<p>Program playback</p>	<p>Press PROGRAM to select a chapter within the title. Pressing again will clear the mode.</p>

C	
<p>Return to navigational system</p>	<p>Pressing PBC returns you to the discs navigational system, which is the normal mode of operation.</p>

Playback Features

Special Playback Features

A Skip	
<p>Fast backward </p> <p>Fast forward </p>	<p>In play mode, press  fast forward or  fast backward. Every press of  or  will change the speed.</p> <p> : Fast backward</p> <div style="display: flex; justify-content: space-around; align-items: center;"> <div style="border: 1px solid black; padding: 2px 10px;">x2</div> <div style="border: 1px solid black; padding: 2px 10px;">x4</div> <div style="border: 1px solid black; padding: 2px 10px;">x6</div> <div style="border: 1px solid black; padding: 2px 10px;">x8</div> <div style="border: 1px solid black; padding: 2px 10px;">play</div> </div> <p> : Fast forward</p> <div style="display: flex; justify-content: space-around; align-items: center;"> <div style="border: 1px solid black; padding: 2px 10px;">x2</div> <div style="border: 1px solid black; padding: 2px 10px;">x4</div> <div style="border: 1px solid black; padding: 2px 10px;">x6</div> <div style="border: 1px solid black; padding: 2px 10px;">x8</div> <div style="border: 1px solid black; padding: 2px 10px;">play</div> </div>

- Note:
- The unit will be muted when skipping forward and backward.
 - Some discs do not support skip playback.
 - Operation may vary from disc to disc.

B Step	
<p>step </p>	<p>Pressing STEP the first time will freeze the picture.</p> <div style="display: flex; align-items: center;"> <div style="border: 1px solid black; padding: 5px; margin-right: 10px;">step</div> <div style="text-align: center;">↓</div> </div> <p>Successive presses will move the picture forward one frame.</p> <div style="display: flex; align-items: center;"> <div style="border: 1px solid black; padding: 5px; margin-right: 10px;">step</div> <div style="text-align: center;">↓</div> </div>

C Pause/Play	
	<p>Press Pause/Play to pause the picture.</p>

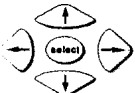
D Return to	
	<p>Press SELECT or PLAY to resume normal play.</p>

- Note:
- The unit will be muted during step playback.

Playback Features

Special Playback Features

You can set chapters/titles to repeat.

C Repeat title/chapter	Repeat your desired title/chapter
	<p>Each press of the REPEAT button will change the repeat mode as follows:</p> <pre> graph TD A[CHAPTER REPEAT ON] --> B[TITLE REPEAT ON] B --> C[REPEAT OFF] C --> A C --> D[return to normal play] </pre> <p>repeat the chapter</p> <p>repeat the title</p> <p>return to normal play</p>

Note: • Some discs do not support repeat playback.

D Repeat passage	You can repeat playback of a segment (A-B)						
	<table border="0"> <tr> <td data-bbox="375 952 590 1041"> <div style="border: 1px solid black; padding: 5px;">A TO B SET A</div> </td> <td data-bbox="606 952 1094 1041"> Press A-B button at the beginning of the desired segment, memorizing the starting point A. </td> </tr> <tr> <td data-bbox="375 1086 590 1176"> <div style="border: 1px solid black; padding: 5px;">A TO B SET B</div> </td> <td data-bbox="606 1086 1094 1176"> Press A-B button at the end of the desired segment. The unit will repeat your selected segment A-B. </td> </tr> <tr> <td data-bbox="375 1220 590 1310"> <div style="border: 1px solid black; padding: 5px;">A-B CANCELLED</div> </td> <td data-bbox="606 1220 1094 1310"> Press A-B button a third time to clear the setting and return to normal. </td> </tr> </table>	<div style="border: 1px solid black; padding: 5px;">A TO B SET A</div>	Press A-B button at the beginning of the desired segment, memorizing the starting point A.	<div style="border: 1px solid black; padding: 5px;">A TO B SET B</div>	Press A-B button at the end of the desired segment. The unit will repeat your selected segment A-B.	<div style="border: 1px solid black; padding: 5px;">A-B CANCELLED</div>	Press A-B button a third time to clear the setting and return to normal.
<div style="border: 1px solid black; padding: 5px;">A TO B SET A</div>	Press A-B button at the beginning of the desired segment, memorizing the starting point A.						
<div style="border: 1px solid black; padding: 5px;">A TO B SET B</div>	Press A-B button at the end of the desired segment. The unit will repeat your selected segment A-B.						
<div style="border: 1px solid black; padding: 5px;">A-B CANCELLED</div>	Press A-B button a third time to clear the setting and return to normal.						

Note:

- The repeated segment can only be selected in the current title.
- A-B Repeat can not be used for multi-angle segments.

Playback Features

Special Playback Features

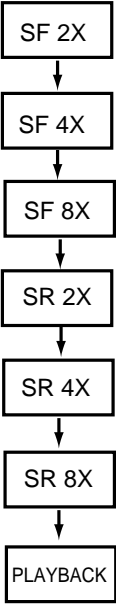
E Slow	You can play back in slow motion.
<p>slow</p> 	<p>Press SLOW button and the speed will change as follows:</p>  <pre>graph TD; A[SF 2X] --> B[SF 4X]; B --> C[SF 8X]; C --> D[SR 2X]; D --> E[SR 4X]; E --> F[SR 8X]; F --> G[PLAYBACK];</pre>

Note:

- Audio will be muted during slow motion.

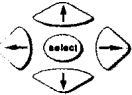
F Return to normal play	
	<p>Press SELECT to resume normal playback.</p>

Playback Features

Special Playback Features

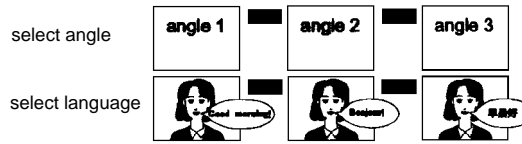

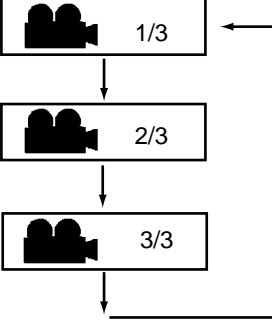
G Select Angle	Use the Angle feature for disc with multi-angle scenes.
angle 	While playing multi-angle scene, press ANGLE to select as follows: 

Note:

- While playing a multi-angle scene, the angle will always be displayed on the screen if the angle is set to ON in the setup menu.

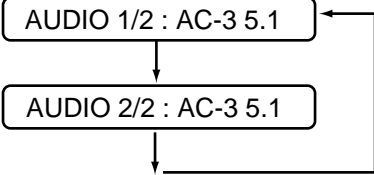
H Select language	Select your desired language from the choices which the disc contains.
language 	In play mode, press the button changing the language.  Every press will change the language.

Note:

- The unit will return to the default setup when you turn on the unit or when you change discs.
- The unit will play the original language if you select a language the DVD disc does not contain.

Playback Features

Special Playback Features

I Mute	
mute 	Press MUTE to turn off the audio. Press MUTE again to resume normal sound.

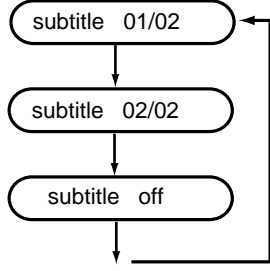

J Select subtitle	You can select subtitles from the choices which the disc contains.
subtitle 	While playing a disc with subtitles, press the SUBTITLE button as follows:  <pre>graph TD; A(subtitle 01/02) --> B(subtitle 02/02); B --> C(subtitle off); C --> A;</pre>

Note:

- The unit will return to default setup when you turn on the device or when you change the disc.
- The unit will display the original subtitle language if you select a subtitle not contained in the disc.
- The subtitle may take a few moments to change.
- Not all discs contain subtitles.

Playback Features

Special Playback Features

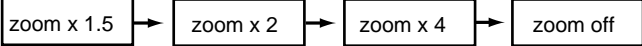



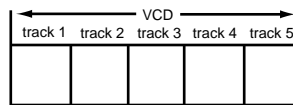

K Memorize the stopped position	The unit can continue playing from the stopped position.
1 stop 	Press STOP at the desired stopping position. The unit will memorize the position. Note: Some discs may not support this function.
2 play 	Press PLAY to start playback from the memorized position.
L Zoom	You can zoom in while watching movies.
1 zoom 	
2 arrow keys	In zoom mode, press the arrow keys to move in the selected direction.

Playing Other Compatible Discs

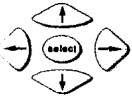
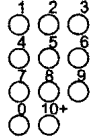
Playing VCDs:





VCDs are divided into multiple tracks.

A Play from menu	If the disc contains a PBC menu, you can select PBC playback. The unit will enter PBC automatically.
1 PBC 	In stop mode, press PBC button, displaying: <div style="float: right; border: 1px solid black; padding: 2px; margin-top: 10px;">PBC ON</div> Note: Not all VCDs contain PBC menus. After reading the disc, the PBC menu will be displayed automatically (if the disc contains a PBC menu).
2 	Press the arrow keys to choose the desired track, then press SELECT. <div style="border: 1px solid black; padding: 5px; margin-top: 10px;"> 1 <input type="checkbox"/> <input type="checkbox"/> <input type="checkbox"/> <input type="checkbox"/> 2 <input type="checkbox"/> <input type="checkbox"/> <input type="checkbox"/> <input type="checkbox"/> <input type="checkbox"/> 3 <input type="checkbox"/> <input type="checkbox"/> <input type="checkbox"/> <input type="checkbox"/> <input type="checkbox"/> <input type="checkbox"/> <input type="checkbox"/> 4 <input type="checkbox"/> <input type="checkbox"/> 5 <input type="checkbox"/> <input type="checkbox"/> <input type="checkbox"/> </div> For example:
3 	Alternatively, press the 0-9 keys to select the desired track. To select a number larger than 0, press 10+ first, then input the next number.
4 return 	In play mode, press RETURN to enter the PBC menu.
5 skip forward  skip backwards 	Press  to skip the next page. Press  to skip the previous page. Note: Some discs may have multi-page menus.

Playing Other Compatible Discs

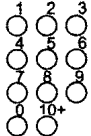
Playing VCDs:

B Play your desired sequence	
1 	In stop mode, press PROGRAM. <div style="border: 1px solid black; padding: 5px; width: fit-content; margin-left: auto;"> PROGRAM 00 : 00 </div>
2 	Press SELECT key, selecting your desired track. If the number is larger than 10, press 10+first, then input the next number.
3 	Press PLAY key, entering program play.
4 	In program mode, press PROGRAM to clear the play mode.

Playing Other Compatible Discs

Playing VCDs:

Often different channels on VCDs contain different languages.

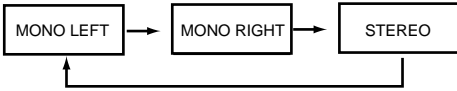
D Select channel channel	In play mode, press CHANNEL key, selecting channel.
channel ○	

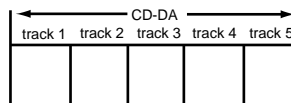

Playing Audio CDs:

Audio CDs are divided into multiple tracks.

1	After reading the disc, it will play automatically.
2 1 ○ 2 ○ 3 ○ 4 ○ 5 ○ 6 ○ 7 ○ 8 ○ 9 ○ 0 ○ 10+ ○	Press number key, selecting your desired track. If the number is larger than 10, press 10+ first, then input the next number.

Note:

- Press ◀◀ or ▶▶ to select the previous or next track.
- Press SEARCH to select playback time.

Playing Other Compatible Discs

Playing MP3 File

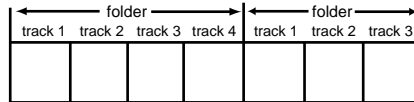

MP3 discs are divided into folders and tracks.

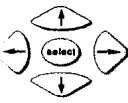
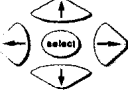

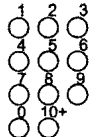
A Select track	
1	The folder menu will be displayed after reading the disc.
2 	Press the arrow keys to select the desired folder.
3 	Press SELECT to enter the item. Press the arrow keys to select the desired track, then press SELECT to play the track.

B Select track directly	
	You can also press the 0-9 keys to select the desired track. If you want to select a number larger than 10, press 10+ first, then enter the second digit.

C Return to title menu	
stop 	Press STOP to stop playback. Press RETURN to return to the title menu.

D Select play mode	
repeat 	Press REPEAT to select the playback mode: REP-ONE, FOLDER-REP, FOLDER

Note:

- Press  or  to select the previous or next track.

Playing Other Compatible Discs

Viewing Kodak Picture CDs:

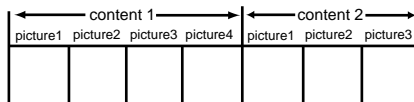

Kodak CDs are picture divided into content and pictures.

A Select content	
1	Insert the disc to display the content menu.
2	Use the arrow keys to select the desired content, then press SELECT.
3	Press the arrow keys to select the desired picture, then press SELECT to view the picture.
4	Press up to play in a clockwise direction, and press down to play counterclockwise. Press left to roll left and right. Press right to roll up and down.







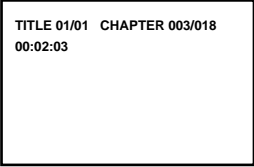

B Select picture directly	
	You can also use the number keys to select the desired picture. To select a number larger than 10, first press 10+ then enter the second number.

C 9-picture digest	
	Press MENU to display a 9-picture digest. Press ◀◀ or ▶▶ will turn pages repeatedly.

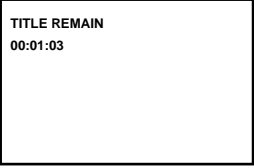
On-Screen Messages

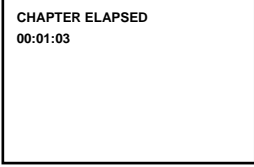
Playback Displays

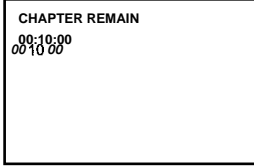
You can see the number of the current chapter, title, time remaining and elapsed time of the current chapter and title.

1 DISPLAY 	Press DISPLAY once to display the elapsed time of the current title.	
2 DISPLAY 	Press DISPLAY twice to display the time remaining in the current title.	
3 DISPLAY 	Press DISPLAY three times to display the elapsed time of the current chapter.	
4 DISPLAY 	Press DISPLAY four times to display the time remaining in the current chapter.	
5 DISPLAY 	Press DISPLAY five times to turn off the time display.	

Note:

- Display information will be different if the disc is not a DVD.

System Setup

Menu Operation

1	Press SETUP to display the setup menu.
2	Press the arrow keys to move to the desired item, then press SELECT to confirm.
3	Press SETUP again to exit the menu. 1. The corresponding indication will appear on the bottom of screen when moving the cursor to selected item. 2. Gray (dimmed) items cannot be set. 3. The setup will be saved after powering off the unit.

GENERAL SETUP MENU

1 Menu Frame	GENERAL PAGE	
	— TV DISPLAY	NORMAL/PS NORMAL/LB WIDE
	— TV TYPE	MULTI NTSC PAL
	— PIC MODE	AUTO HI-RES N-FLICKER
	— ANGLE MARK	ON OFF
	— CAPTIONS	ON OFF
	— SCR SAVER	ON OFF
	— MAIN PAGE	

System Setup

General Setup Page

2 TV DISPLAY	<p>A. NORMAL/PS - Select to view DVD movies full screen on a standard 4:3 television. Movies will be cropped (using a technique called Pan & Scan) to fit your television.</p> <p>B. NORMAL/LB - Select to view DVD movies in letterbox format (black bars will appear above and below the image).</p> <p>C. WIDE - Select if you have a widescreen television.</p>
3 TV TYPE	<p>To setup the video output to adapt TV.</p>
4 PIC MODE	<p>A. AUTO - Automatically selects the optimal Still Mode by detecting motion in the scene.</p> <p>B. HI-RES - Select if you want to see fine text more clearly than in AUTO mode.</p> <p>C. N-FLICKER - Select if the screen shakes in AUTO mode.</p>
5 ANGLE MARK	<p>When playing multi-angle DVD discs, select whether the angle should be displayed.</p>
6 SCR SAVER	<p>When the unit is in stop or freeze mode, a screensaver will appear several minutes later to protect your television screen.</p>

System Setup

Speaker Setup

<p>1 Menu frame</p>	<p>Speaker Setup page</p> <p>DOWNMIX LT/RT STEREO</p> <p>MAIN PAGE</p>
<p>2 DOWNMIX</p>	<p>Set the type of front speakers you are using: LT/RT Select when using an external Dolby Pro Logic decoder. STEREO: Outputs a stereo signal.</p>

System Setup

Audio Setup

1 Menu frame	
2 AUDIO OUT	Select the audio output mode: ANALOG: No signal from coaxial or optical outputs. SPDIF/RAW: Select if the unit is connected to an amplifier with a Dolby Digital or DTS decoder via the optical or coaxial digital audio outputs. SPDIF/PCM: Select if the unit is connected to a 2-channel stereo amplifier.
3 OP MODE	LINE OUT: Standard digital audio setting. RF REMOD: Use for older RF digital inputs.
4 DUAL MONO	Select STEREO, L-MONO, R-MONO or MIX-MONO to get stereo, left, right or mixed sound from the analog outputs.
5 DYNAMIC	When the output mode is set to Line out, select this mode to adjust the effect of dynamic compression.

KARAOKE SETUP

1. Menu Frame
 - KARAOKE MODE OFF
 - KARAOKE
 - MAIN PAGE
2. Karaoke Mode You can use this setup to control karaoke mode

System Setup

Preferences Setup

<p>1</p> <p>Menu frame</p>	<p>Note: You can only enter Preferences setup from stop or no disc mode.</p> <pre> AUDIO ENGLISH FRENCH SPANISH CHINESE JAPANESE SUBTITLE ENGLISH FRENCH SPANISH CHINESE JAPANESE OFF DISC MENU ENGLISH FRENCH SPANISH CHINESE JAPANESE PARENTAL PASSWORD CHANGE DEFAULTS RESET MAIN PAGE 1 G 2 3 PG 4 PG 13 5 6 PG-R 7 NC-17 8 ADULT NO-PARENTAL </pre>
<p>2</p> <p>Audio Subtitle, Disc Menu</p>	<p>Enter your preferred language for Audio soundtracks, Subtitle languages and Disc menu languages. Available languages vary by disc.</p>
<p>3</p> <p>Parental setup</p>	<p>You can use this setup to control playback of rated discs.</p>
<p>4</p> <p>Password</p>	<p>Select Reset, enter and confirm the new password, then press PLAY.</p>
<p>5</p> <p>Defaults</p>	<p>Return to the default setup.</p>
<p>6</p> <p>Smart Nav</p>	<p>Choose whether or not to display menus.</p>

Current Password: 8806

Troubleshooting

Symptoms and Solutions

If you have any questions, please refer to the following table before seeking service.

Symptom	Reason(s)	Solutions
No power	Not connected	Connect unit to wall outlet.
No picture	Video cable not securely connected	Connect video cable
No sound	Audio cable not securely connected	Connect audio cable
	External amplifier/decoder off	Power on amplifier/decoder
	Incorrect audio output setting	Set to correct mode
Distorted picture	Disc is dirty	Clean disc or try another one
	Distortion in fast forward or backward mode	Normal condition.
Brightness unsteady or picture with noise	External equipment	
No playback	No disc	Insert disc
	Disc not readable	Insert readable disc (check disc type)
	Disc loaded upside down	Replace disc with label side up
	Disc incorrectly loaded	Load the disc correctly
	Disc is dirty	Clean the disc
	TV screen has menu	Press Setup to turn off the menu.
	Parental lock enabled	Unlock it or change the rating
Keys do not function	Abnormal condition	Switch on/off power or unplug/replug the power cord.
Remote control does not work	Remote not pointed directly at unit	Point remote directly at IR sensor.
	Remote too far from unit	Operate remote within 25 feet
	Batteries are dead	Replace batteries

Specifications

DVD Player/Output

DVD Player

Power Supply	110-240V AC 50/60Hz
Power Consumption	25W
Weight	3.6 Kg
Dimension	430 x 82 x 260 (W/H/D)
Video System	PAL
Laser	SL Beam, wave length: 650nm
Frequency Response	DVD audio: 48KHz PCM 4Hz~22Hz 96KHz PCM 4Hz~44KHz
S/N Ratio	Audio CD 4Hz~20KHz >90db
Audio Dynamic Range	>90db
Rotating Ratio	Within measurable range
Operation Condition	Temperature 0-40C; Operation status: horizontal

Output

Video Output	1.0 V(P-P), 75 Ω
S-video Output	(Y) 1.0 V(P-P), 75 Ω (C) 0.286 V(P-P), 75 Ω
Audio Output (Analog Audio)	2.0 V(rms)

Additional Information

Care of discs:

Do not touch the surface.

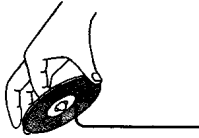

Do not add labels or adhesive tapes on discs.



Cleaning of discs:

Fingerprints or stains on the discs surface will directly affect signal recording and result in poor picture quality. Therefore, use a soft cloth and wipe in a circular manner from the center to the outer edges when cleaning the disc.

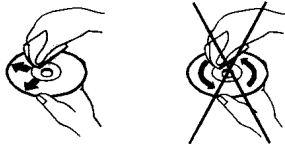

If the surface of your disc is very dirty, wipe the disc with a moist cloth. Finally use a dry soft cloth to remove all the water stains.

Never use electrostatic prevention products or solutions which contain benzene, thinner or any other vaporizing substances, as they may damage the disc surface.

Storage of disc:

Do not keep the disc in direct sunlight, near a heat source, in dusty places or near moisture (kitchen, bathroom). Keep the disc vertically in the disc storage case. Heavy objects on the disc case will cause deformation of the disc.

PALSONIC CORPORATION PTY LTD
1 JOYNTON AVENUE
WATERLOO NSW 2017 AUSTRALIA
TEL:(02)9313 7111
FAX:(02)9313 7555
www.palsonic.com.au

**PALSONIC CUSTOMER SERVICE
TELEPHONE
AUSTRALIA: 1300 657 888**

Free Manuals Download Website

<http://myh66.com>

<http://usermanuals.us>

<http://www.somanuals.com>

<http://www.4manuals.cc>

<http://www.manual-lib.com>

<http://www.404manual.com>

<http://www.luxmanual.com>

<http://aubethermostatmanual.com>

Golf course search by state

<http://golfingnear.com>

Email search by domain

<http://emailbydomain.com>

Auto manuals search

<http://auto.somanuals.com>

TV manuals search

<http://tv.somanuals.com>