

**OWNER'S MANUAL**

# **Palsonic**

**106CM WIDE SCREEN PDP TV/MONITOR**

**MODEL: PDP4220HD**



**N111**

**PALSONIC CORPORATION PTY LTD  
1 JOYNTON AVENUE  
WATERLOO NSW 2017 AUSTRALIA  
TEL:(02)9313 7111  
FAX:(02)9313 7555**

**PALSONIC CUSTOMER SERVICE  
TELEPHONE  
AUSTRALIA:1300 657 888**

## IMPORTANT INFORMATION

If a television is not positioned in a sufficiently stable location, it can be potentially hazardous due to falling. Many injuries, particularly to children, can be avoided by taking simple precautions such as:

- Using cabinets or stands recommended by the manufacturer of the television.
- Only using furniture that can safely support the television.
- Ensuring the television is not overhanging the edge of the supporting furniture.
- Not placing the television on tall furniture (for example, cupboards or bookcases) without anchoring both the furniture and the television to a suitable support.
- Not standing the televisions on cloth or other materials placed between the television and supporting furniture.
- Educating children about the dangers of climbing on furniture to reach the television or its controls.

# Table of Contents

---

Important Safety Precautions.....	1
Important Notice.....	3
Preparations.....	4
Identification of Controls.....	6
Connections.....	9
Basic Operations.....	13
Memorizing the Channels.....	15
Channel and Program Selection.....	19
Picture Adjustment.....	20
Sound Adjustment.....	21
System Setup.....	23
Rating and Lock Setup.....	24
Timer Setup.....	26
EPG Operation.....	28
Teletext & Subtitle.....	29
Screen setup for D-SUB (PC) Mode.....	30
Troubleshooting.....	31
Specifications.....	33

# Important Safety Precautions

Electrical energy can perform many useful functions, but it can also cause personal injuries and property damage if improperly handled. This product has been engineered and manufactured with the highest priority on safety. But IMPROPER USE CAN RESULT IN POTENTIAL ELECTRICAL SHOCK OR FIRE HAZARD. In order to prevent potential danger, please read the following instructions when installing, operating and cleaning the product. To ensure your safety and prolong the service life of your new TV product, please read the following precautions carefully before using the product.

**1. Read these instructions**---All operating instructions must be read and understood before the product is operated.

**2. Keep these instructions**---These safety and operating instructions must be kept in a safe place for future reference.

**3. Heed all warnings**---All warnings on the product and in the instructions must be observed closely.

**4. Follow all instructions**---All operating instructions must be followed.

**5. Attachments**---Only use attachments/accessories specified by the manufacturer. Do not use attachments not recommended by the manufacturer. Use of improper attachments can result in accidents.

**6. Power source**---This product is intended to be supplied by a listed power supply indicated on the marking label. If you are not sure of the type of power supply to your home, consult your product dealer or local power company. For added protection for this product during a lightning storm, or when it is left unattended and unused for long periods of time, unplug it from the wall outlet and disconnect the cable system.

**7. Power cord protection**---Protect the power cord from being walked on or pinched particularly at plugs, convenience receptacles, and the point where they exit from the apparatus.

Note: where the mains plug or an appliance coupler is used as the disconnect device, the disconnect device shall remain readily operable.

**8. Overloading**---Do not overload wall outlets, extension cords, or convenience receptacles on other equipment as this can result in a risk of fire or electric shock.

**9. Entering of objects and liquids**---Never insert an object into the product through vents or openings. High voltages are present in the product, and inserting an object can cause electric shock and/or short internal parts. For the same reason, do not spill water or liquid on the product.

**10. Servicing**---Refer all servicing to qualified service personnel. Servicing is required when the apparatus has been damaged in any way, such as power-supply cord or plug is damaged, liquid has been spilled or objects have fallen into the apparatus, the apparatus has been exposed to rain or moisture, does not operate normally, or has been dropped.

**11. Damage requiring service**---If any of the following conditions occurs, unplug the power cord from the AC outlet, and request a qualified service person to perform repairs.

a. When the power cord or plug is damaged.

b. When a liquid is spilled on the product or when objects have fallen into the product.

c. When the product has been exposed to rain or water.

d. When the product does not operate properly as described in the operating instructions.

Do not touch the controls other than those described in the operating instructions. Improper adjustment of controls not described in the instructions can cause damage, which often requires extensive adjustment work by a qualified technician.

e. If the product has been dropped or the cabinet has been damaged in any way.

f. When the product displays an abnormal condition or exhibits a distinct change in performance. Any noticeable abnormality in the product indicates that the product needs servicing.

**12. Replacement parts**---In case the product needs replacement parts, make sure that the service person replaces parts specified by the manufacturer, or those with the same characteristics and performance as the original parts. Use of unauthorized parts can result in fire, electric shock and/or other danger.

**13. Safety checks**---Upon completion of service or repair work, request the service technician to perform safety checks to ensure that the product is in proper operating condition.

**14. Wall or ceiling mounting**---When mounting the product on a wall or ceiling, be sure to install the product according to the method recommended by the manufacturer. This is a safety feature.

## Important Safety Precautions (Continued)

**15. Stand**---Use only with the cart, stand, tripod, bracket, or table specified by the manufacturer, or sold with the apparatus. Do not place the product on an unstable trolley, stand, tripod or table. Placing the product on an unstable base can cause the product to fall, resulting in serious personal injuries as well as damage to the product. When mounting the product on a wall, be sure to follow the manufacturer's instructions. Use only the mounting hardware recommended by the manufacturer.



**16. Careful move**---When a cart is used, use caution when moving the cart/apparatus combination to avoid injury from tip-over. Sudden stops, excessive force and uneven floor surfaces can cause the product to fall from the trolley. Never attempt to move the TV unless the AC power cord has been disconnected.



**17. Lightning**---Unplug this apparatus during lightning storms or when unused for long periods of time.

For added protection for this television equipment during a lightning storm, or when it is left unattended and unused for long periods of time, unplug it from the wall outlet and disconnect the antenna. This will prevent damage to the equipment due to lightning and power-line surges.

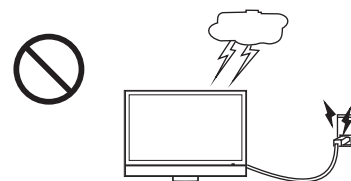

**18. Do not use this apparatus near water**---for example, near a bathtub, washbowl, kitchen sink, or laundry tub, in a wet basement, or near a swimming pool, and the like. Do not use immediately after moving from a low temperature environment, as this causes condensation, which may result in fire, electric shock, or other hazards.



**19. Clean only with dry cloth**---Unplug this product from the wall outlet before cleaning. Do not use liquid cleaners or aerosol cleaners. Use a damp cloth for cleaning.

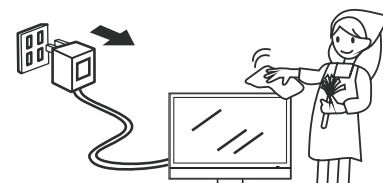

**20. Ventilation**---Do not block any ventilation openings. Install in accordance with the manufacturer instructions. The vents and other openings in the cabinet are designed for ventilation. Do not cover or block these vents and openings since insufficient ventilation can cause overheating and/or shorten the life of the product. Do not place the product on a bed, sofa, rug or other similar surface, since they can block ventilation openings. This product is not designed for built-in installation; do not place the product in an enclosed place such as a bookcase or rack, unless proper ventilation is provided or the manufacturer's instructions are followed.

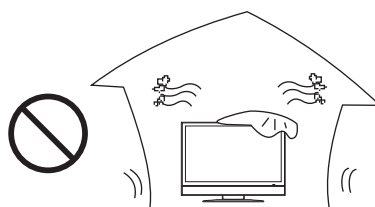

**21. Heat sources**---Do not install near any heat sources such as radiators, heat registers, stoves, or other apparatus (including amplifiers) that produce heat.



**22. Panel protection**---The display panel used in this product is made of glass. Therefore, it can break when the product is dropped or impacted upon by other objects. Be careful not to be injured by broken glass pieces in case the display panel breaks.



**23. Pixel defect**---The display panel is a very high technology product, giving you finely detailed pictures. Occasionally, a few non-active pixels may appear on the screen as a fixed point of blue, green or red. Please note that this does not affect the performance of your product.

**Warning:** For continued safety, apparatus with class I construction shall be connected to a mains socket outlet with a protective earthing connection.

# Important Notice

---

---

## About Temperature

### Do not use in hot and cold rooms (locations)

- When the unit is used in rooms (locations) with low temperature, the picture may leave trails or appear slightly delayed. This is not a malfunction, and the unit will recover when the temperature returns to normal.
- Do not leave the unit in a hot or cold location. Also, do not leave the unit in a location exposed to direct sunlight or near a heater, as this may cause the cabinet to deform and the screen to malfunction.
- Storage temperature: 0°C to +50°C
- Working temperature: 5°C to +40°C

---

## About After-Image

The extended use of fixed image program material can cause a permanent after-image on the screen.

This background image is viewable on normal programs in the form of a stationary fixed image. This type of irreversible screen deterioration can be limited by observing the following steps:

- A. Reduce the brightness/contrast setting to a minimum viewing level.
- B. Do not display the fixed image for extended periods of time.
- C. Turn the power off when not in actual use.

### Important Information Regarding Use of Video Games, Computers, Captions or Other Fixed Image Displays.

- Do not allow a still picture to be displayed for an extended period, as this can cause a permanent after-image to remain on the screen.

Examples of still pictures include logos, video games, computer images, teletext and images displayed in 4:3 mode.

### CAUTIONS:

- The permanent after-image on the screen resulting from fixed image use is not an operating defect and as such is not covered by the warranty.
- This product is not designed to display fixed images for extended periods of time.

---

## Cleaning and Maintenance

### To clean this unit, wipe with a soft, dry cloth.

If the surfaces are extremely dirty, use a soft cloth dipped in a soap and water solution or a weak detergent solution.

- Use eyeglass cleaner to remove stubborn dirt from the screen.
- Never use alcohol, paint thinner or benzine to clean this unit.
- Before using a chemically treated cloth, read the instructions that came with the cloth carefully.

# Preparations

## Using the Remote Control

- Use the remote control by pointing it towards the remote sensor window of the set. Objects between the remote control and sensor window may prevent proper operation.

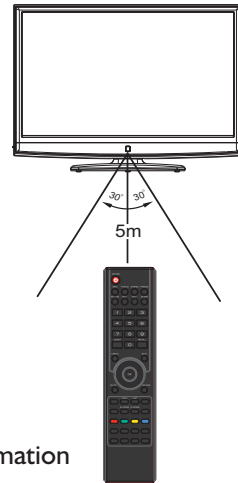

### Cautions regarding use of remote control

- Do not expose the remote control to shock. In addition, do not expose the remote control to liquids, and do not place in an area with high humidity.
- Do not install or place the remote control under direct sunlight. The heat may cause deformation of the unit.
- The remote control may not work properly if the remote sensor window of the main unit is under direct sunlight or strong lighting. In such a case, change the angle of the lighting or the TV set, or operate the remote control closer to the remote sensor window.

## Installing the Batteries

If the remote control fails to operate the TV functions, replace the batteries in the remote control.

- 1 Open the battery cover.
- 2 Insert two size-AAA batteries.
  - (Place the batteries with their terminals corresponding to the (+) and (-) indications in the battery compartment.)
- 3 Replace the cover and slide in reverse until the lock snaps.

### Precaution on battery use

Improper use of batteries can result in a leakage of chemicals and/or explosion. Be sure to follow the instructions below.

- Place batteries with their terminals corresponding to the (+) and (-) indications.
- Different types of batteries have different characteristics. Do not mix batteries of different types.
- Do not mix old and new batteries. Mixing old and new batteries can shorten the life of new batteries and/or cause old batteries to leak chemicals.
- Remove batteries as soon as they are non-operable. Chemicals that leak from batteries can cause a rash. If chemical leakage is found, wipe with a cloth.
- If the remote control is not used for an extended period of time, remove the batteries from the remote control.
- The batteries (battery pack of batteries installed) shall not be exposed to excessive heat such as sunshine, fire or the like.

## Preparations (continued)

### Antenna Connection

INSTALL the unit in a room where direct light will not fall upon the screen. Total darkness or a reflection on the picture screen may cause eyestrain. Soft and indirect lighting is recommended for comfortable viewing.

Optimum reception of color requires a good signal and will generally mean that an outdoor antenna must be used. The exact type and position of the antenna will depend upon your particular area.



#### Note

- It is recommended that the 75-ohm coaxial cable be used to eliminate interference and noise which may occur due to radio wave conditions.
- The antenna cable should not be bundled with the power cord.

### Power Connection

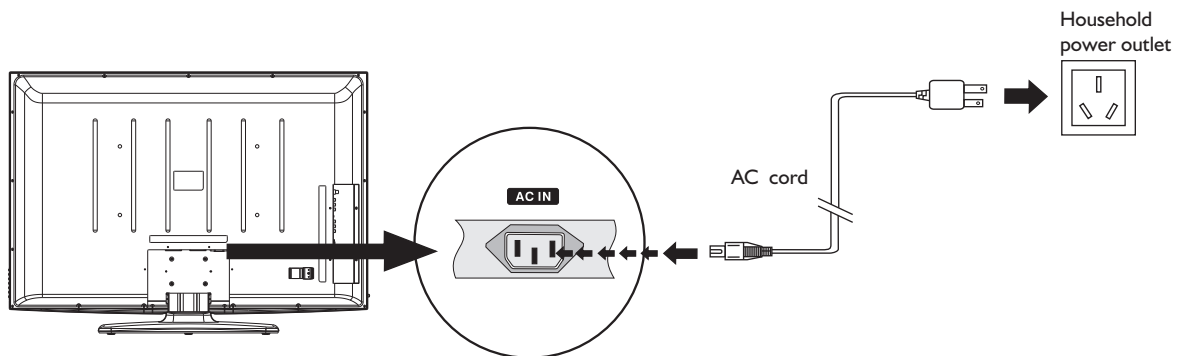

1. Connecting the female plug to the AC socket on the unit.
2. Connecting the male plug to the wall outlet as illustrated.

#### Note

- This illustration is for reference only. The AC plug may be different on different models.
- This product should be operated only from the type of power source indicated on the marking label.
- Always unplug the AC cord from power outlet when not using for a long period of time.



# Identification of Controls

## Main Unit (front view/side view)

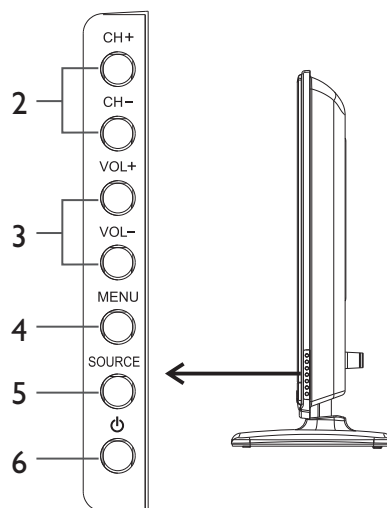
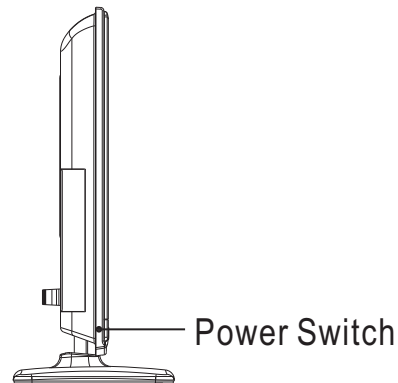
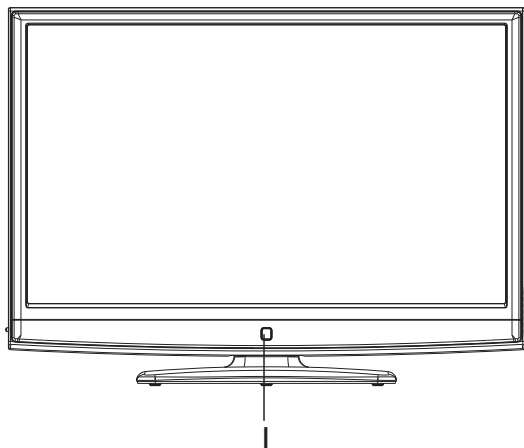

### 1. Indicator/Remote Sensor

### 2. CH +/-

Press these two buttons to directly change the TV channel;  
In OSD menu, press these buttons to choose the OSD items.

### 3. VOL +/-

Press the **VOL+** or **VOL-** button to directly increase or decrease the sound volume level;  
In OSD menu, press these buttons to adjust the value or setting of each item.

### 4. MENU

Press this button to access Menu main page.

### 5. SOURCE

To access input source select menu.

### 6. POWER

Press this button to turn the unit ON from STANDBY mode. Press it again to turn the set back to STANDBY.

### Note

Functions of **CH +/-**, **VOL +/-**, **MENU**, **SOURCE** and **POWER ** and are also provided to the remote control. This operation manual provides a description based on operating functions with the remote control.

# Identification of Controls (Continued)

## Main Unit (rear view)

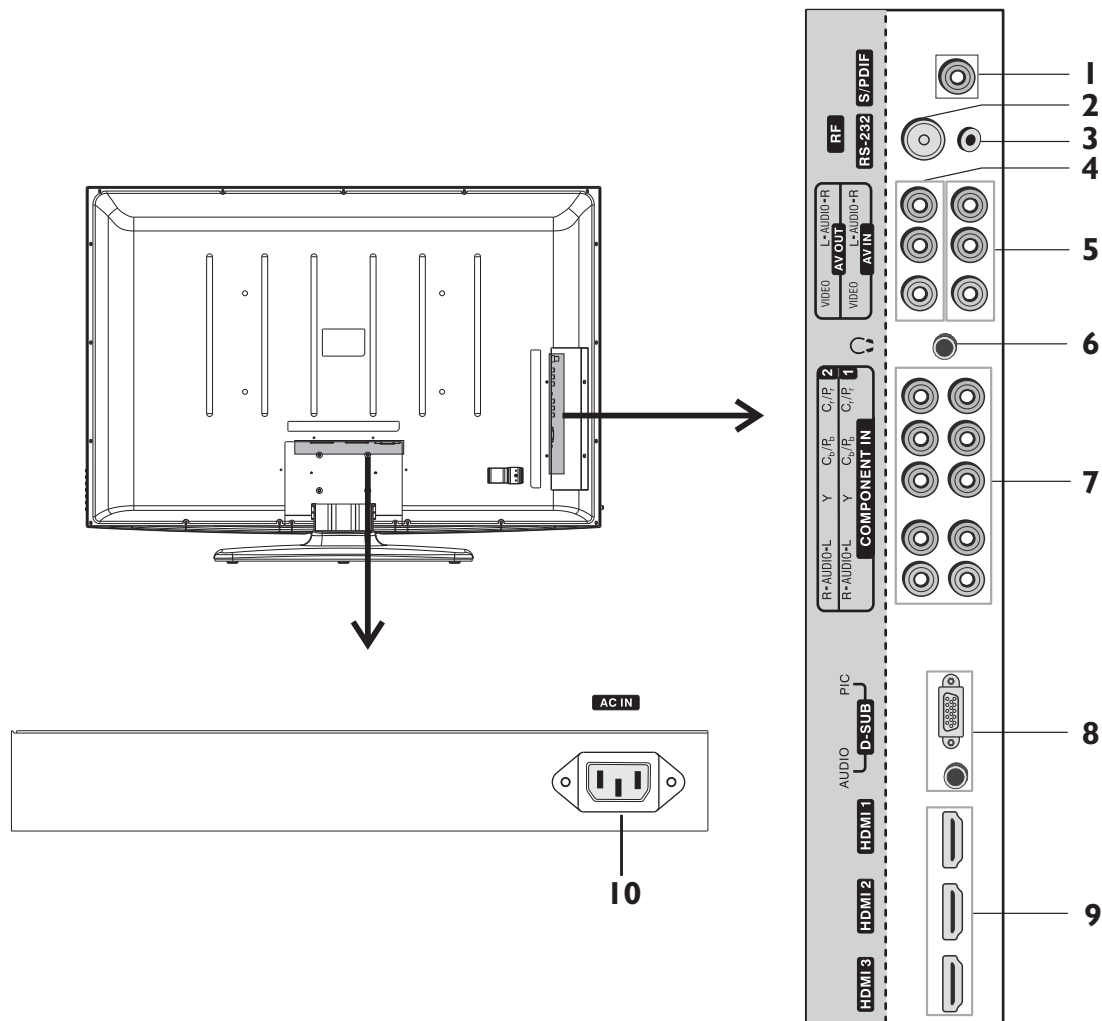

### 1. S/PDIF digital audio out terminal(coaxial)

Connect to the digital audio input of a digital audio component.

### 2. Antenna input

Connect to your cable system or outdoor antenna.

### 3. RS232 interface

For service use . The user cannot operate the unit through this terminal.

### 4. AV outputs(Video, Audio L, R)

Connect to your VCR to record programs.

### 5. AV inputs (Video, Audio L, R)

Receive video/audio signal from external sources such as VCR or DVD player.

### 6. Headphone jack

Connect to your headphones.

### 7. COMPONENT 1/2 inputs

Connect to the audio and component output jacks of a DVD player or Set-Top Box.

### 8. D-SUB input

Connect to the D-SUB/AUDIO output jack on your computer.

### 9. HDMI 1/2/3 interface

To connect with those equipments with HDMI or DVI interface, for example, Set-top box or DVD player. (A HDMI-to-DVI adapter cable is required when you are connecting a DVI-equipped device to this TV.)

### 10. AC Power input

Connect to AC power cord.

# Identification of Controls (Continued)

## Remote Control Unit

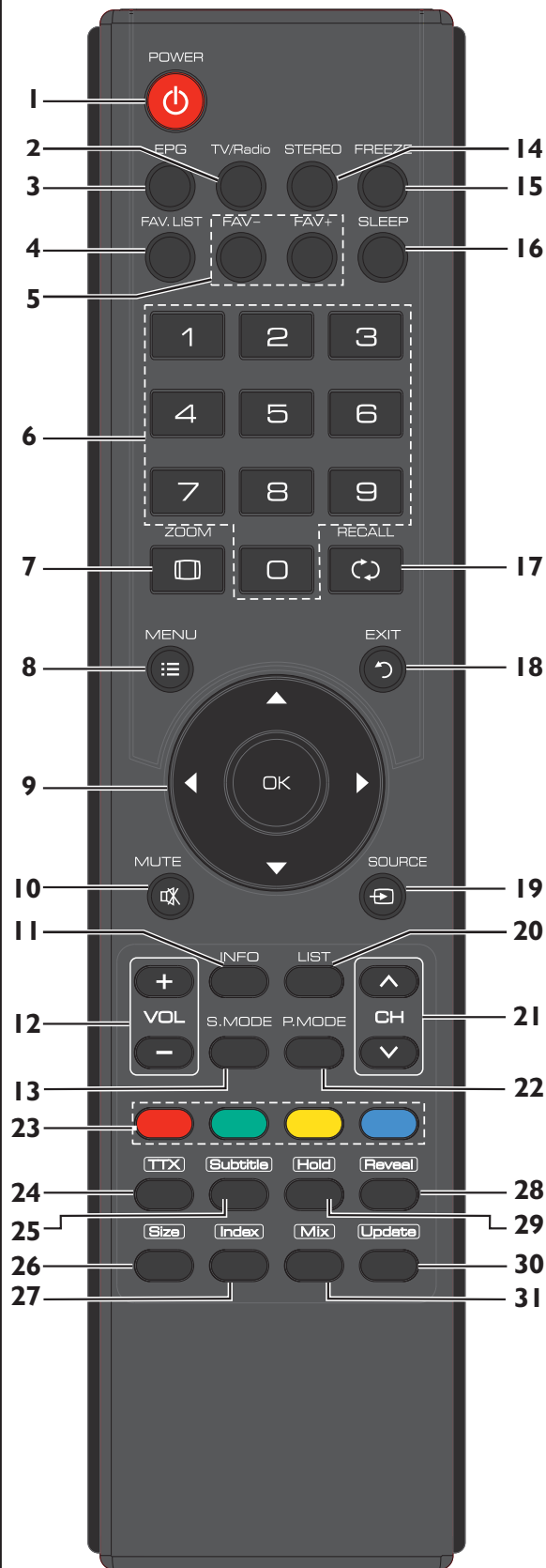

- 1 POWER:** Switches the TV power on or Standby.
- 2 TV/Radio:** Switches between TV and Radio mode. (DTV only)
- 3 EPG:** Displays the Electronic Program Guide (DTV only).
- 4 FAV.LIST:** Displays the favorite channel list.
- 5 FAV+ / FAV-:** Selects the favorite channel.
- 6 0 – 9 number buttons:** Press to enter channel numbers or input password.
- 7 ZOOM:** Selects the screen size.
- 8 MENU:** Displays the main menu screen.
- 9 ▲/▼/◀/▶/OK:** Press the arrows to navigate through the menus or adjust an item. Press **OK** to confirm a selection or enter a sub-menu.
- 10 MUTE:** Mutes the sound.
- 11 INFO:** Displays the information banner.
- 12 VOL+/-:** Increases or decreases the volume.
- 13 S.MODE:** Selects sound mode.
- 14 STEREO:** Selects bilingual, stereo or mono ( ATV only ), or audio track(DTV only).
- 15 FREEZE:** To freeze current picture.
- 16 SLEEP:** Sets the sleep timer.
- 17 RECALL:** Returns to the previous channel.
- 18 EXIT:** Exits the menu screen.
- 19 SOURCE:** Displays input source menu.
- 20 LIST:** Displays the channel list.
- 21 CH^/▼:** Changes channel up and down.
- 22 P.MODE:** Selects picture mode.

### Below is teletext control buttons:

- 23 Colored buttons (RED/GREEN/YELLOW/BLUE):** Direct access to the colored items or corresponding pages. (Teletext)
- 24 TTX:** Used to enter or exit teletext mode. (Teletext)
- 25 Subtitle:** Displays the subtitle (DTV only), or the teletext subpage (ATV only).
- 26 Size:** Press this button several times to display the upper, then the lower part of the screen and then return to the normal size teletext page. (Teletext)
- 27 Index:** Press this button to view the main index page. (Teletext)
- 28 Reveal:** To reveal or hide the concealed information. (Teletext)
- 29 Hold:** To stop or resume sub-page acquisition. (Teletext)
- 30 Update:** Press the button to view the updated teletext page. (Teletext)
- 31 Mix:** Press the button to display the Teletext on the screen with transparent background while viewing the TV program simultaneously. (Teletext)

# Connections

## Cautions before connecting

- Carefully check the terminals for position and type before making any connections.
- The illustration of the external equipment may be different depending on your model.
- Loose connectors can result in image or color problems. Make sure that all connectors are securely inserted into their terminals.
- Refer to the operating manual of the external device as well.
- When connecting an external device, turn the power off to avoid any issues.

## Connecting a Camcorder

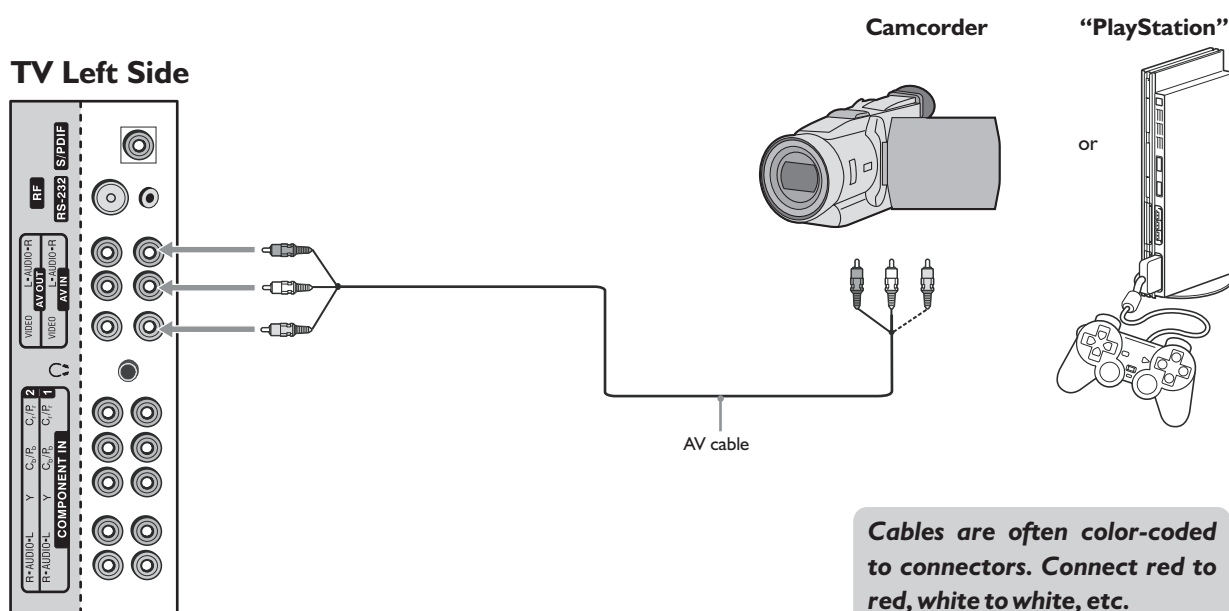

### How to connect:

Connect the Audio/Video cables between the Audio (L/R)/Video jacks on the unit and camcorder.

### To playback Camcorder

1. Turn on your TV, then press **SOURCE** button. The **Input Source** menu opens.
2. Press **▲** or **▼** to select **AV**, then press **OK** to confirm.
3. Turn on your camcorder and set it to output mode. (For details, refer to your camcorder user manual.)
4. Insert the tape into the camcorder and press **Play** button.

### Note

The operations of the camcorder may be different and is dependant on your model. Please read the user manual of your camcorder to confirm operation.

# Connections (Continued)

## Connecting Component Video

**TV Left Side**

*Cables are often color-coded to connectors. Connect red to red, white to white, etc.*

Component video cable

Audio cable

**DVD Player**

**To connect a device using component video:**  
Connect the Component Video cable between the Y, Cb/Pb, Cr/Pr input jacks on the unit and Y, Cb/Pb, Cr/Pr output jacks on the device.  
Connect the Audio cable between the AUDIO input jacks on the unit and AUDIO output jacks on the device.

**To play component video from an external device:**

1. Turn on your TV, then press **SOURCE** button. The **Input Source** menu opens.
2. Press **▲** or **▼** to select **Component 1/Component 2** correspondingly, then press **OK** to confirm.
3. Turn on your external device and set it to the correct mode. See the device's user guide for more information.

## Connecting a Computer

**TV Left Side**

AUDIO

D-SUB

HDMI 1

HDMI 2

HDMI 3

D-Sub cable (analog RGB)

Audio cable (stereo mini plugs)

To monitor port (15-pin D-Sub)

To audio output jack

**How to connect:**  
Connect a D-Sub cable between the D-SUB jack on the computer and the D-SUB input jack on the unit.  
Connect an Audio cable between the AUDIO output on the computer and AUDIO input jack on the unit.

**To play video from a computer**

1. Turn on your TV, then press **SOURCE** button. The **Input Source** menu opens.
2. Press **▲** or **▼** to select **D-SUB**, then press **OK** to confirm.
3. Turn on your computer, and adjust the display properties as required.

# Connections (Continued)

## Connecting an HDMI device

**TV Left Side**

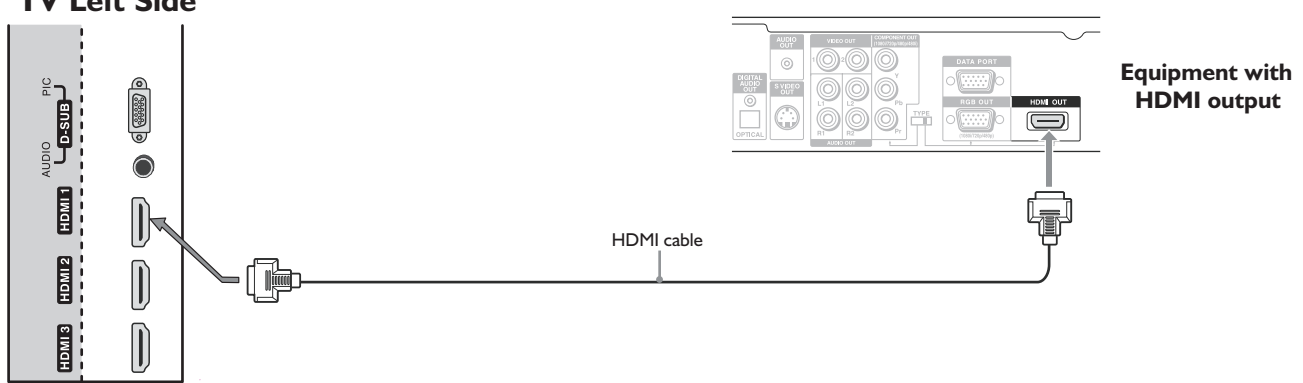

**Equipment with HDMI output**

**How to connect a device using HDMI Connection:**  
Connect the HDMI cable between the HDMI interface on the unit and HDMI output on the device.

**To play from the device using HDMI:**

1. Turn on your TV, then press **SOURCE** button. The **Input Source** menu opens.
2. Press **▲** or **▼** to select **HDMI 1/HDMI2/HDMI3** correspondingly, then press **OK** to confirm.
3. Turn on your device and set it to the correct mode. See the device's user guide for more information.

**Note**  
If the external device has DVI output only, use a DVI to HDMI adapter cable to connect to the HDMI terminal. Connect the audio cable to the D-SUB AUDIO IN jack on the TV side.

## Connecting a VCR (for Recording)

**TV Left Side**

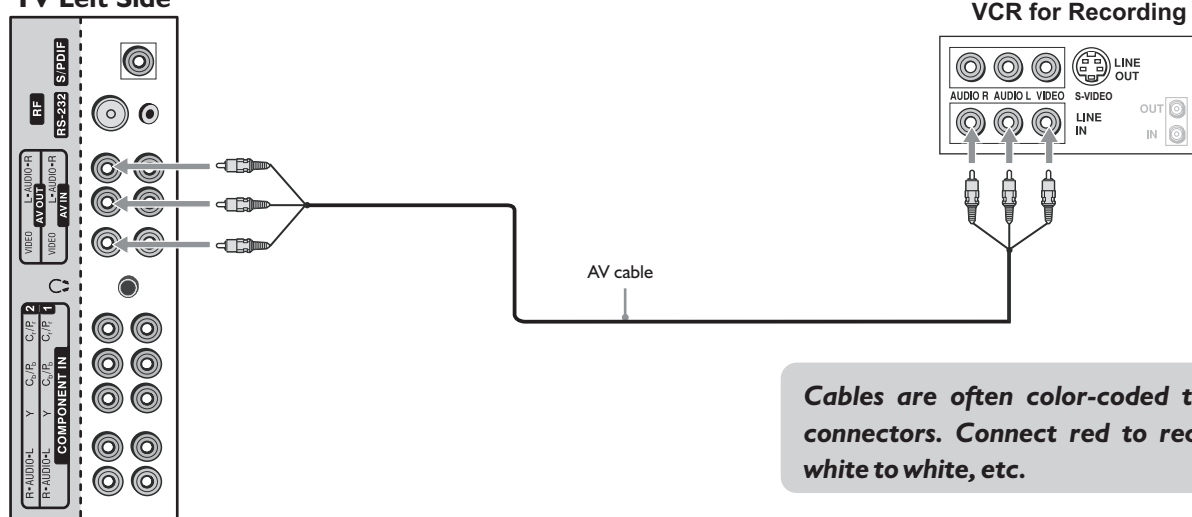

**VCR for Recording**

**How to connect:**  
Connect the Audio/Video cables between the Audio (L/R)/Video jacks on the unit and VCR.

**To record program**

1. Turn on your TV, select a program you wish to record.
2. Turn on your VCR, insert a videotape for recording.
3. Press the Record button to begin recording.

**Note**  
Cables are often color-coded to connectors. Connect red to red, white to white, etc.

• **Only analog TV programs, and AV input sources can be output through the AV output jacks.**

## Connections (Continued)

### Connecting Digital Coaxial Audio

**TV Left Side**

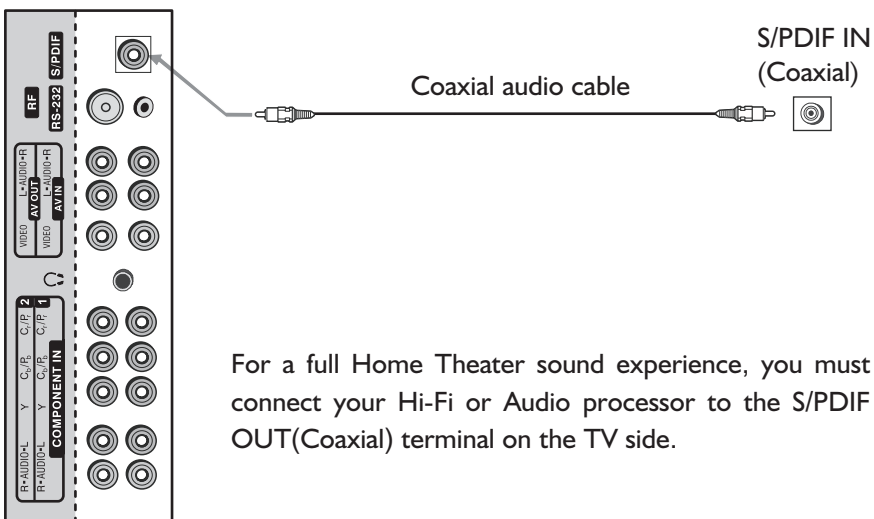

S/PDIF IN (Coaxial)

Coaxial audio cable

S/PDIF OUT (Coaxial)

Audio Processor

or

HIFI System

For a full Home Theater sound experience, you must connect your Hi-Fi or Audio processor to the S/PDIF OUT (Coaxial) terminal on the TV side.

**Note**

The S/PDIF OUT jack is available only when a digital TV channel is received.

### Connecting Headphones

Insert the plug of the headphone into the TV's Headphone jack.

When using headphones, adjust the headphone volume so as to avoid excessive levels, as hearing damage may result.

**TV Left Side**

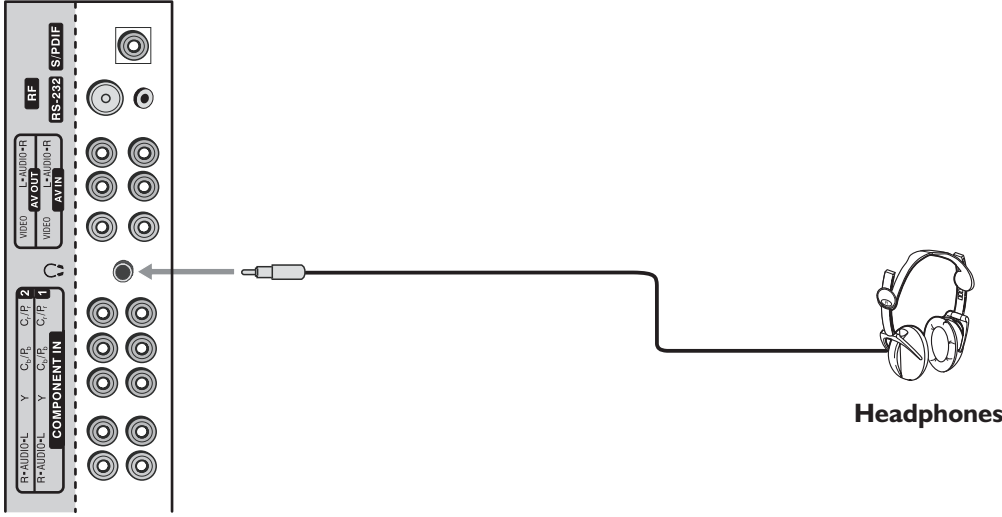

Headphones

# Basic Operations

## Main Menu Overview

### List of main menus to help you with operations

#### PICTURE menu

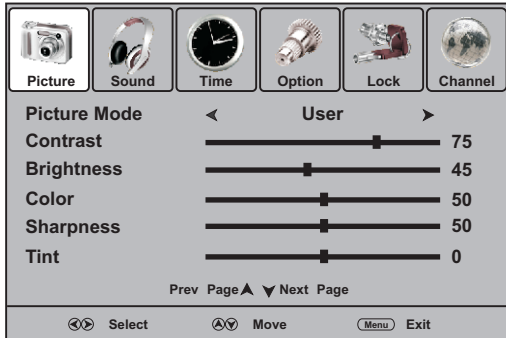

#### SOUND menu

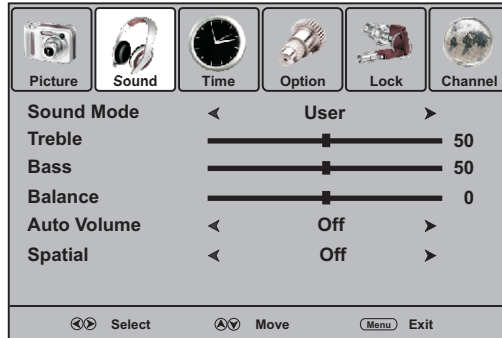

#### TIME menu

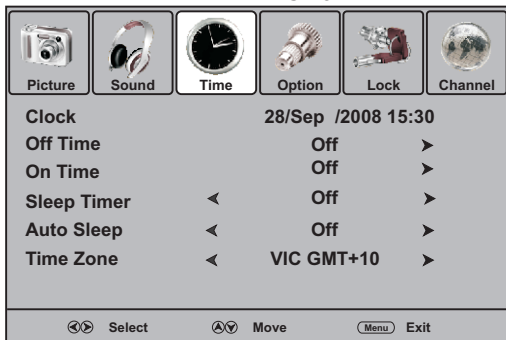

#### OPTION menu

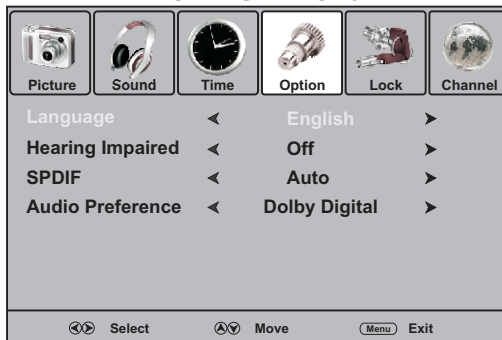

#### LOCK menu

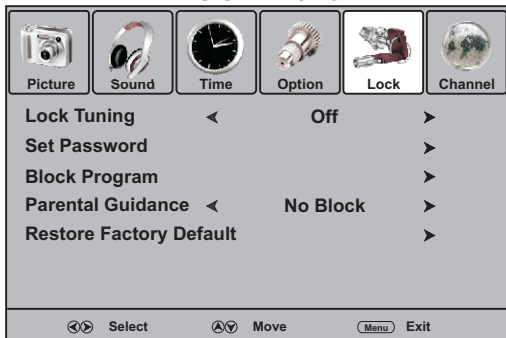

#### CHANNEL menu

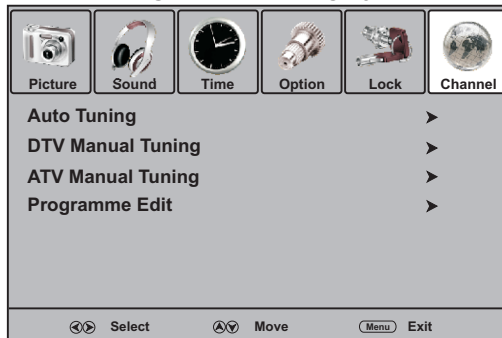

### To navigate through the OSD main menu

- 1 With the power on, press **MENU** and the main menu screen displays.
- 2 Press **<** or **>** to select menu. Press **>** to access the menu.
- 3 Within the menu, press **&u2191**, **&u2193**, **<** or **>** navigate through the options or adjust an option. Press **OK** to confirm a selection or enter a sub-menu.
- 4 Press **MENU** to return to previous menu. Press **EXIT** to exit the menu screen directly. Or you may wait for a few seconds and the on-screen menu will disappear from the screen automatically.

#### Note

- Some menu items may be different when the unit works in different mode, and menu items that are not selectable are grayed out.
- The **Picture** menu has more than one page, please use **&u2191** or **&u2193** to scroll through.
- The illustrations and on-screen displays in this manual are for explanation purpose (some are enlarged, others cropped) and may vary slightly from the actual ones.



# Basic Operations (Continued)

## Turning On/Off the Power

### ■ Turning On

Insert the power cord into the wall outlet. Press the **Power Switch** on the unit to power on.

If the unit is in standby mode, press **Power** button on the unit or the remote control to turn on the unit, and you will be ready to use its features.

### ■ Turning Off

With the power on, press the **Power** button on the unit or on the remote control to turn off the unit, and put the unit in standby mode. To cut off the power completely, press the **Power Switch** directly.

## Selecting the Input Signal Source

1 Press **SOURCE** button.

- 2 Press **▲** or **▼** to select the input source. Options include:
- **DTV** — Watch the DTV signal.
  - **ATV** — Watch the ATV signal.
  - **AV** — Watch the signal from the AV input terminals.
  - **Component 1** — Watch the signal from the COMPONENT 1 input terminals.
  - **Component 2** — Watch the signal from the COMPONENT 2 input terminals.
  - **D-SUB** — Watch the signal from the D-SUB input jack.
  - **HDMI 1** — Watch the signal from the HDMI 1 input jack.
  - **HDMI 2** — Watch the signal from the HDMI 2 input jack.
  - **HDMI 3** — Watch the signal from the HDMI 3 input jack.

3 Press **◀**, **▶** or **OK** to confirm the selection.

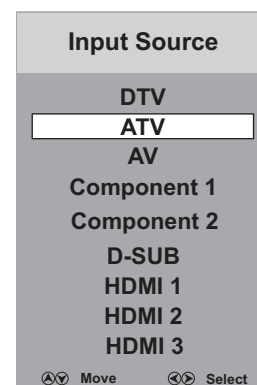

## Displaying the Information Banner

Press the **INFO** button to display the information banner. The information banner displays current status information such as the channel number and signal source.

Depending on the mode, different information is displayed. In DTV mode, more information will be displayed. Below is an example banner in DTV mode.

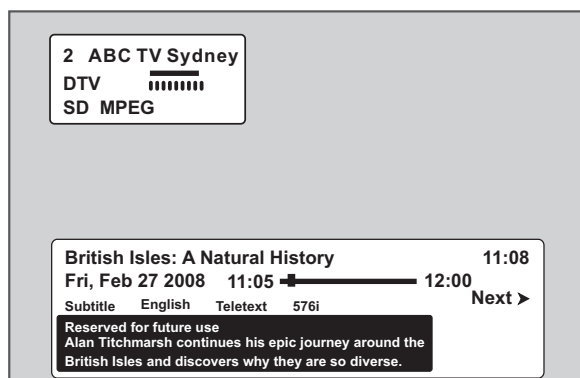

In DTV mode, the information banner may contain:

- Channel number and name.
- Current time.
- Current program name, start and end play times.
- Next program name and start and end play times.
- TV or Radio.
- Audio mode, audio track.
- Signal strength for current channel.
- Signal resolution.
- Subtitle, teletext.

### Note

- The above OSD is only served as an example, and it is in DTV mode.
- Information banner content varies, depending on the broadcaster and your settings.

# Memorizing the Channels

When you turn on the TV for the first time, you should perform an auto channel search to set up stations on your TV.

**Note:** Be sure to select the proper input source (ATV/DTV) before operation.

## Auto Channel Search

You should perform an auto channel search to search for all channels available and stores them in memory.

And before you start **Auto Tuning**, it is necessary to select a country firstly.

- 1 Press **MENU** and the main menu screen displays.
- 2 Press **◀** or **▶** to select **Channel** menu, press **▼** to access the menu.
- 3 Highlight **Auto Tuning** item, and press **▶** or **OK** to access.
- 4 Now a confirmation box appears on the screen. Press **◀** or **▶** to highlight **Start** item, and then press **OK** to begin the auto channel search. (If you want to cancel, press **▶** to select **Cancel** item, and use **OK** to confirm.)
- 5 Then the TV begins memorizing all ATV/DTV channels available in your area. During the process, you can press **MENU** to skip the search, or **EXIT** to stop.

### Note

- In the confirmation box, the **Country Selection** item is defaulted to be **Australia** and cannot be adjusted.

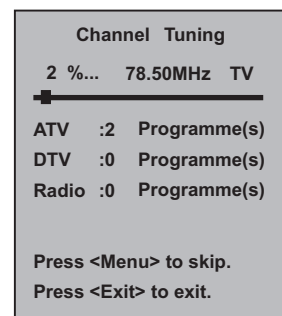

## Manual Searching for DTV programs

If desired digital programs cannot be searched by Auto Tuning, you can make use of **DTV Manual Tuning** to search programs manually.

- 1 In **Channel** menu, press **▼** or **▲** to select **DTV Manual Tuning** item, then press **▶** or **OK** to access.
- 2 Highlight **VHF CH** ( or **UHF CH**) item, press **◀** or **▶** button to select your desired channel number.
- 3 Press **OK** to begin the manual DTV channel search.  
At the bottom of the menu screen the **DTV Signal** strength bar is displayed. You can make use of it to check how strong your DTV signal is and whether you need to adjust your antenna or digital cable input. The higher the signal strength is, the less likely you are to experience picture degradation.
- 4 Then all the digital programs available in this channel will be searched and stored. During the process, you can press **MENU** or **EXIT** to exit the search.

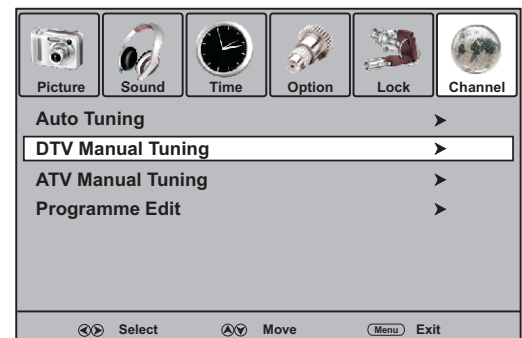

# Memorizing the Channels (Continued)

## Manual Searching for ATV programs

If desired analog programs cannot be searched by Auto Tuning, you can make use of **ATV Manual Tuning** to search programs manually.

- 1 In **Channel** menu, press  $\downarrow$  or  $\uparrow$  to select **ATV Manual Tuning** item, then press  $\rightarrow$  or **OK** to access.
- 2 Highlight **Storage To** item, press  $\leftarrow$  or  $\rightarrow$  button to select a channel position in which you want to store.
- 3 Use  $\downarrow$  or  $\uparrow$  to select **Search** item, press  $\leftarrow$  or  $\rightarrow$  to begin the manual ATV channel search.  
Press  $\rightarrow$ , the unit searches towards higher frequency;  
Press  $\leftarrow$ , the unit searches towards lower frequency.
- 4 The search stops when a program is found and this program will be stored in current channel, then press the **RED** button to save. During the process, if you want to stop the search, please press **EXIT** button.

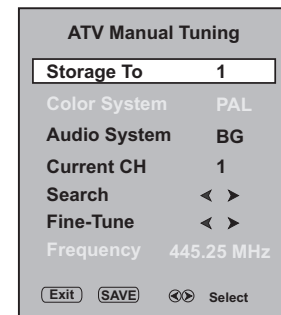
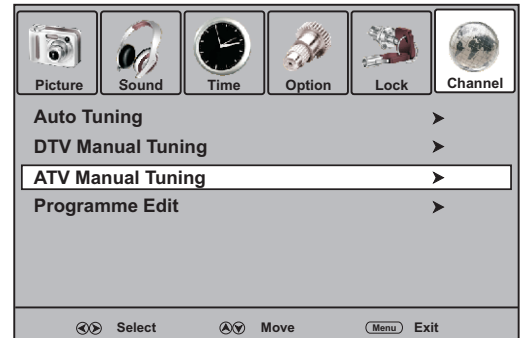

## Manual Fine Tuning

Fine Tuning is not necessary under normal conditions. However, in area of inferior broadcast conditions where adjustment is necessary for a better picture and sound effect, use Fine Tune.

- 1 Navigate to **ATV Manual Tuning** submenu, highlight **Current CH** item, press  $\leftarrow$  or  $\rightarrow$  to select a channel you want to perform fine tune.
- 2 Press  $\downarrow$  to select **Fine-Tune** item, and then use  $\leftarrow$  or  $\rightarrow$  button to fine tune until the best possible picture and sound are obtained.
- 3 During the process, press **EXIT** to exit, and **RED** button to save the effect.

### Note

- Fine Tune is only for analog TV program.

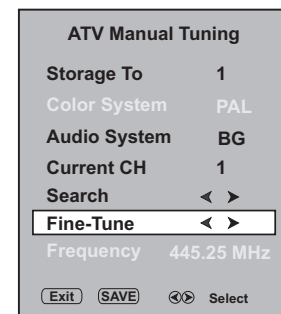

## Setting Audio System

Normally it is unnecessary to set audio system. However, if abnormal sound occurs, you may try to adjust the audio system.

- 1 Navigate to **ATV Manual Tuning** submenu, press  $\uparrow$  or  $\downarrow$  to highlight the **Audio System** item.
- 2 Press  $\leftarrow$  or  $\rightarrow$  to select the proper audio system. Press **RED** button to save.
- 3 Press **MENU** to return to previous menu. Press **EXIT** to exit the menu screen directly.

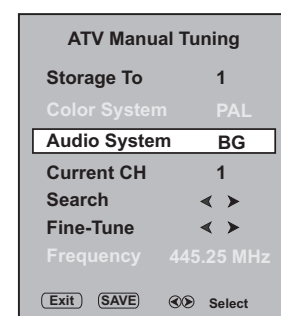

# Memorizing the Channels (Continued)

## Labeling Channels

If required, you can give a name to the programs.

- 1 Press **MENU** and the main menu screen displays.
- 2 Press **◀** or **▶** to select **Channel** menu, press **▼** to access the menu.
- 3 Press **▼** or **▲** to select **Programme Edit** item, press **▶** or **OK** to open the **Programme Edit** menu.
- 4 Within the program list, press **▼** or **▲** to select a channel you want to edit, press **GREEN** button to start to label. Then a name symbol appears alongside.
- 5 Use **▼** or **▲** to select character to input, use **◀** or **▶** to move the cursor. To delete the inputting, please press **RED** button. After finishing inputting, press **OK** to confirm. The maximum length of label is 5 characters. Repeat the above steps to set up more channel labels.

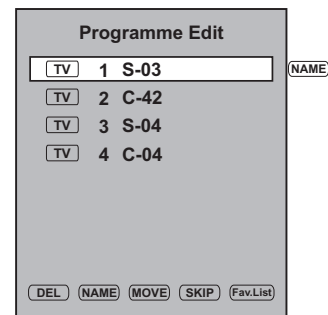
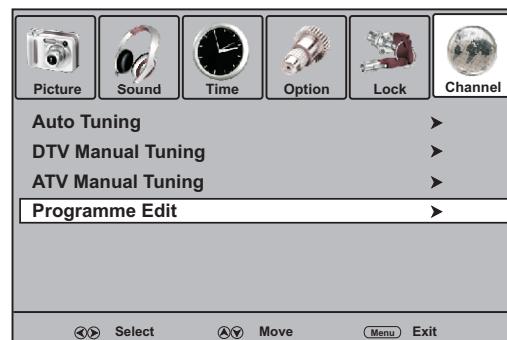

### Note

- The labels of DTV channels are automatically assigned and cannot be changed by user.
- There will be no **NAME** item in DTV mode.

## Setting Favorite Channels

You can set up favorite channels list so that you can quickly browse through your favorite channels by using Favorite button.

- 1 Navigate to the **Channel** menu, press **▲** or **▼** to select **Programme Edit** item, press **▶** or **OK** to open the **Programme Edit** menu.
- 2 Use **▼** or **▲** to select your favorite program, use **FAV.LIST** button to mark the selected program as favorite (a favorite symbol appears). To cancel the favorite mark, just press **FAV.LIST** button again and the symbol disappears. If the program list has more than one page, you can press **▼** or **▲** to scroll the page. Repeat the above steps to set more favorite programs.
- 3 To exit, press **EXIT** button. Now you can press **FAV.LIST** button to display the favorite list, press **▼** or **▲** to browse through the favorite programs and press **OK** to access the channel. Or you can use **FAV+ / FAV-** to cycle among the favorite channels.

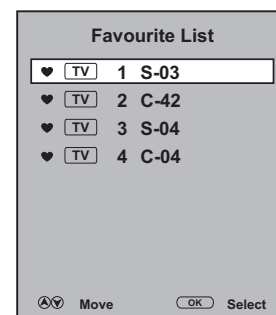

# Memorizing the Channels (Continued)

## Channel List Management

After auto search, a default channel list is created. You can make use of Programme Edit menu to select program, to skip unnecessary channels, to delete channels, to sort programs, and to create a favorite channel list.

### ■ To skip unnecessary channels

After auto search, you can skip unnecessary channels so that only the channels you want to watch can be selected by CH $\wedge$ /CH $\vee$ .

- 1 Navigate to **Channel** menu and press  $\blacktriangledown$  or  $\blacktriangle$  to select **Programme Edit** item and then press  $\blacktriangleright$  or **OK** to access.
- 2 Press  $\blacktriangledown$  or  $\blacktriangle$  to select your unwanted channel, press **BLUE** button and a skip symbol appears alongside the selected channel in the list, which means this channel will be skipped.
- 3 If you want to skip more channels, repeat the above steps to set more skip symbols to more channels.  
Press **EXIT** to quit the list. Now when you press Channel $\wedge$ / $\vee$ , these unwanted channels will be skipped.

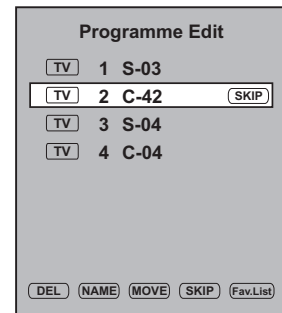

#### Note

- If the Programme Edit menu has more than one page, you may press  $\blacktriangle$  or  $\blacktriangledown$  to scroll the page upward or downward.
- To restore a skipped channel, navigate to the **Programme Edit** menu, select the channel and press **BLUE** button to cancel the skip symbol.

### ■ To sort channels

This function allows you to arrange the channel order.

- 1 Select the channel you want to move in the **Programme Edit** menu.
- 2 Press **YELLOW** button and a move symbol appears alongside the selected channel in the list, then use  $\blacktriangle$  or  $\blacktriangledown$  to move the channel upward or downward to a desired new position. Press **YELLOW** button again to finish the sorting.
- 3 Repeat the above steps for each channel you wish to move.

#### Note

- If the Programme Edit menu has more than one page, you may press  $\blacktriangle$  or  $\blacktriangledown$  to scroll the page upward or downward.
- The order of the DTV channels is automatically assigned and cannot be changed by user.
- There will be no **MOVE** item in DTV mode.

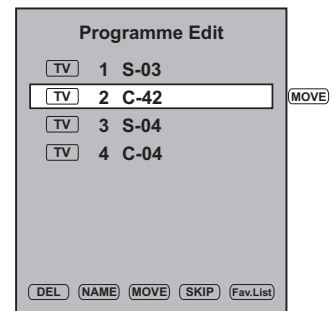

### ■ To delete channels

This function allows you to delete your unwanted channels.

- 1 Select the channel you want to delete in the **Programme Edit** menu.
- 2 Press **RED** button and a delete symbol appears alongside the selected channel in the list. Press **RED** button again to finish the delete.
- 3 Repeat the above steps for more channels you want to delete.

#### Note

- If the Programme Edit menu has more than one page, you may press  $\blacktriangle$  or  $\blacktriangledown$  to scroll the page upward or downward.
- The deleted channels cannot be found unless you perform a channel search again.

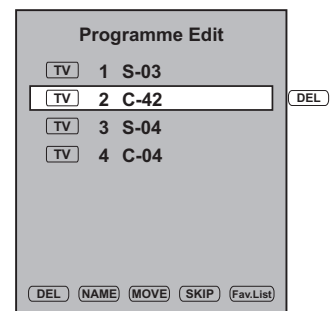

# Channel and Program Selection

Please note: your new TV is capable of receiving both radio and TV broadcasts. And for TV reception, your new TV is capable of receiving both traditional analog channels and digital channels.

**When watching digital TV program and you want to listen to radio program, simply press TV/Radio button to switch. To return to TV program, press TV/Radio button again.** (When watching analog TV program, the TV/Radio button does not work.)

The TV allows channel and program selection in the following ways:

## ■ Method 1— Using CH $\wedge$ or CH $\vee$

Press the CH $\wedge$  or CH $\vee$  to cycle among all available channels. The skipped channels can not be selected by CH $\wedge$  or CH $\vee$  button.

### Note

- By using CH $\wedge$  or CH $\vee$ , you can not select analog channels in DTV mode, or digital channels in ATV mode.

## ■ Method 2— Using RECALL button

Press **RECALL** to switch to the previously tuned channel.

Press **RECALL** again to switch back to the currently tuned channel.

### Note

- **RECALL** will not work if no channel has been changed after TV is turned on.

## ■ Method 3— Using 0 – 9 and OK button

Press the **0 – 9** number buttons to input a channel number, then wait for some seconds or press **OK** to go directly to that channel.

When selecting, the TV will indicate the channel through the information banner.

### Note

- By using **0 – 9** number buttons, you can not select analog channels in DTV mode, or digital channels in ATV mode.
- When in Radio mode, you can press TV/Radio button to switch to TV mode.
- If you input one-digit or two-digit channel number, you can press OK to go directly to the channel without waiting.

## ■ Method 4— Using channel list

Press **LIST** button to display the channel list. Use  $\blacktriangle$  or  $\blacktriangledown$  to select a channel and then press **OK** button.

### Note

- If the channel list has more than one page, you may press  $\blacktriangle$  or  $\blacktriangledown$  to scroll the page upward or downward.

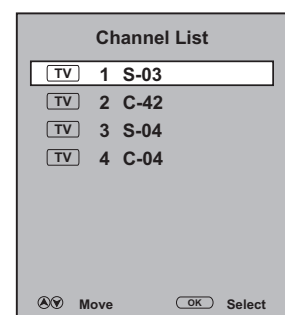

## ■ Method 5— Using favorite channel list

After you have created the favorite channel list, you can press **FAV.LIST** button to display the favorite channel list. Use  $\blacktriangle$  or  $\blacktriangledown$  to select a channel and then press **OK** button.

### Note

- You can directly press **FAV+** / **FAV-** button to cycle among the favorite channels.

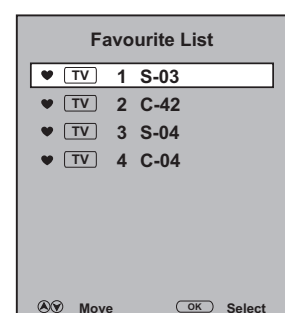

# Picture Adjustment

## Customizing the Picture

- 1 Press **MENU** and the main menu screen displays.
- 2 Press **◀** or **▶** to select **Picture** menu, press **▼** to access the menu.
- 3 Within the menu, press **▲** or **▼** to scroll through the page upward or downward, and press **▲**, **▼**, **◀**, **▶** to navigate through the options or adjust an option.
- 4 Press **MENU** to return to previous menu. Press **EXIT** to exit the menu screen directly.

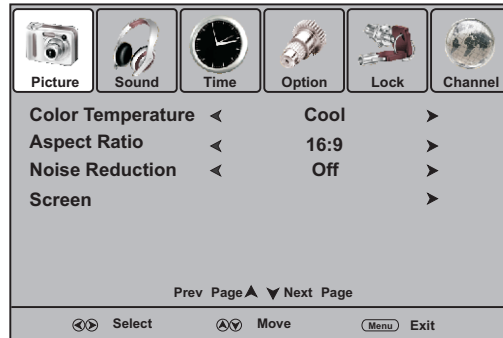
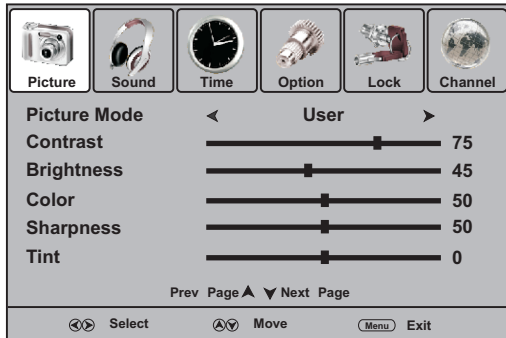

Option	Description
<b>Picture Mode</b>	Selects a desired picture mode. You can select from <b>Standard</b> , <b>Dynamic</b> , <b>Mild</b> and <b>User</b> . <b>Standard:</b> Select for a standard picture. <b>Dynamic:</b> Select for a bright and vivid picture. <b>Mild:</b> Select for a finely detailed picture. <b>User:</b> The picture quality you set.
<b>Note:</b> To quickly change the picture mode, press the <b>P.MODE</b> button on the remote control repeatedly.	
<b>Contrast</b>	Adjusts image contrast.
<b>Brightness</b>	Adjusts screen brightness for easier viewing of dark picture such as night scenes and black hair.
<b>Color</b>	Adjusts color saturation.
<b>Sharpness</b>	Adjusts image sharpness and displays a sharp image.
<b>Tint</b>	Adjusts tint for image.
<b>Note:</b> The Tint item is only for NTSC system.	
<b>Color Temperature</b>	Selects one of three automatic color adjustments. Sets to <b>Warm</b> to enhance hotter colors such as red, or set to <b>Cool</b> to see less intense colors with more blue. You can select from <b>Warm</b> , <b>Cool</b> and <b>Normal</b> .
<b>Aspect Ratio</b>	You can select the aspect ratio (display proportions) according to your video signal type or personal preference. You can select from <b>16:9</b> , <b>Zoom1</b> , <b>Zoom2</b> , <b>Auto</b> and <b>4:3</b> . <b>16:9:</b> Displays a 16:9 picture. <b>Zoom1:</b> Enlarges the picture to fill the full screen. <b>Zoom2:</b> Enlarges the picture, the top and bottom portions may be cropped. <b>Auto:</b> Displays picture automatically in proper ratio. <b>4:3:</b> Displays a 4:3 picture.
<b>Note:</b> You can press the <b>ZOOM</b> button repeatedly to select a desired aspect ratio. When selecting <b>Zoom1/Zoom2</b> , you may use <b>▲</b> or <b>▼</b> to move the picture upward or downward, or press <b>▶</b> or <b>◀</b> to zoom in or out the picture. Do not let image display in 4:3 mode for extended periods of time.	
<b>Noise Reduction</b>	Select from <b>Low/Middle/High</b> to reduce noise in the picture, commonly called snow. Select <b>Off</b> to turn off this function.

# Sound Adjustment

## Adjusting the Volume

### ■ Using the volume buttons (VOL+ and VOL – )

Press the **VOL +** or **VOL-** to increase or decrease the volume.

### ■ Using the Mute

Press the **MUTE** button to temporarily turn off all sound. To restore the sound, press the **MUTE** button again.

## Adjusting the Sound

- 1 Press **MENU** and the main menu screen displays.
- 2 Press **◀** or **▶** to select **Sound** menu, press **▼** to access the menu.
- 3 Within the menu, press **▲** or **▼** to navigate through the options, press **◀** or **▶** to adjust an option.
- 4 Press **MENU** to return to previous menu. Press **EXIT** to exit the menu screen directly.

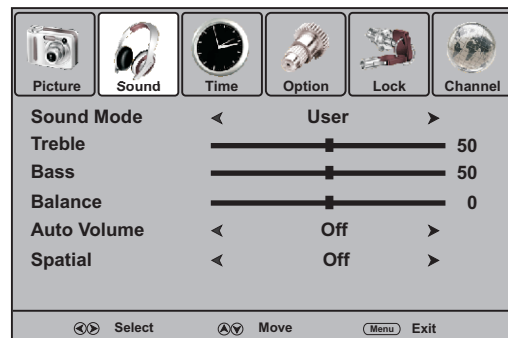

Option	Description
<b>Sound Mode</b>	Selects a desired sound mode. You can select from <b>Standard, Music, Movie, Sports</b> and <b>User</b> . <b>Standard:</b> Select for normal programs. <b>Music:</b> Select for a music program. <b>Movie:</b> Select for a movie program. <b>Sports:</b> Select for a sports program. <b>User:</b> The sound quality you set.
<b>Treble</b>	Adjusts Treble (high sounds).
<b>Bass</b>	Adjusts Bass (low sounds)
<b>Balance</b>	Adjusts volume balance (left and right volumes).
<b>Auto Volume</b>	Select <b>On</b> to equalize overall volume levels across all channels. Select <b>Off</b> to turn off the auto volume control.
<b>Spatial</b>	Select <b>On</b> to turn on the surround sound effect. The benefits of surround sound are enormous. You can be completely enveloped in sound, just as if you were at a concert hall or cinema. Select <b>Off</b> to turn off surround sound.

**Note:** To quickly change the sound mode, press the **S.MODE** button repeatedly.



## Sound Adjustment (Continued)

---

### Stereo/Bilingual Selection (for analog channels)

You can quickly select sound multiplex mode by using the **STEREO** button on the remote control.

#### ■ NICAM Broadcast Selection

This enables the selection of the reception mode when receiving a NICAM signal. To let you enjoy NICAM broadcasting, this TV set receives NICAM system stereo, bilingual, and monaural broadcasts.

##### Stereo

When the TV set is receiving a stereo broadcast, press the **STEREO** button to select **Stereo** or **Mono**. When **Mono** is selected, the TV sound is output monaurally.

##### Bilingual

When the TV set is receiving a bilingual program, press the **STEREO** button to select **NICAM DUAL A** or **NICAM DUAL B**.

#### ■ IGR (German stereo system) Broadcasts

This enables the selection of the reception mode when receiving an IGR signal. To let you enjoy IGR broadcasting, this TV set receives IGR system stereo and bilingual broadcasts.

##### Stereo

When the TV set is receiving a stereo broadcast, press the **STEREO** button to select **Stereo** or **Mono**. When **Mono** is selected, the TV sound is output monaurally.

##### Bilingual

When the TV set is receiving bilingual program, press the **STEREO** button to select **DUAL A** or **DUAL B**.

### Audio Track Selection (for digital channels)

The digital-TV transmission system is capable of simultaneous transmission of many audio tracks (for example, simultaneous translations of the program into foreign languages, or different commentators for sport events). You can press **STEREO** button to select the audio track.

#### Note

- *The availability of these additional "multi-tracks" depends upon the broadcaster.*

# System Setup

## System Setup

You may change system settings such as Hearing impaired, SPDIF, Audio Preference etc. by making use of Option menu.

- 1 Press **MENU** and the main menu screen displays.
- 2 Press ◀ or ▶ to select **Option** menu, press ▼ to access the menu.
- 3 Within the menu, press ▲, ▼, ◀, ▶ to navigate through the options or adjust an option.
- 4 Press **MENU** to return to previous menu. Press **EXIT** to exit the menu screen directly.

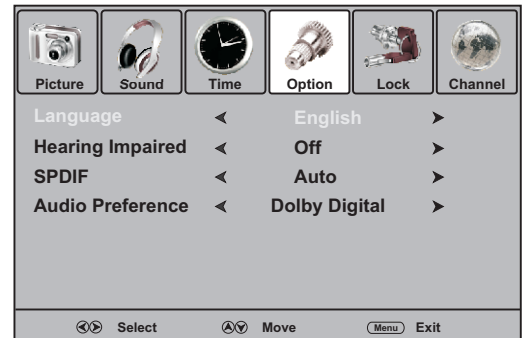

Option	Description
<b>Language</b>	Selects on-screen menus language.
<b>Note:</b> The default selection of this item is <b>English</b> , and cannot be adjusted.	
<b>Hearing Impaired</b> (Only for digital programs)	Press ◀ / ▶ to select <b>On</b> to display the subtitles (if available) for the hearing impaired. Select <b>Off</b> to turn off the function.
<b>SPDIF</b> (Only for digital programs)	Selects the digital audio output mode for S/PDIF. You can select <b>Auto</b> or <b>PCM</b> . <b>Auto:</b> Output audio signal by the rule: If current audio track is in Dolby Digital format, then Dolby Digital format will be selected. If current audio track is in MPEG, then PCM format will be selected. <b>PCM:</b> Output audio signal by PCM format.
<b>Note:</b> To select <b>Auto</b> is recommended.	
<b>Audio Preference</b> (Only for digital programs)	Selects the audio track to output. You can select <b>MPEG</b> or <b>Dolby Digital</b> . <b>MPEG:</b> If the program has MPEG and Dolby Digital tracks, select MPEG to output MPEG track in preference. <b>Dolby Digital:</b> If the program has MPEG and Dolby Digital tracks, select Dolby Digital to output Dolby Digital track in preference.

# Rating and Lock Setup

## Password Setup

The Password setup sub-menu is used to set a new system password or to change an existing system password. By default, the system password is 0000 and you may change it. To access Parental Guidance, to lock or unlock channels, to view locked channels, etc., the system password is required.

### To create a new password

- 1 Press **MENU** and the main menu screen displays.  
Press **◀ / ▶** to select **Lock** menu, press **▼** to access the menu.
- 2 Now a password is required to input. Use number buttons to input the correct password (the default password is 0000).
- 3 Press **▲** or **▼** to select **Set Password** item, and then press **▶** or **OK** button to access its submenu.
- 4 Use the number buttons to input a new password (4- digit).
- 5 Input the new password again.  
Now the new password has been created successfully.

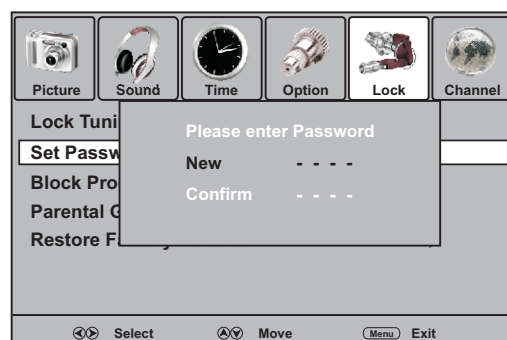
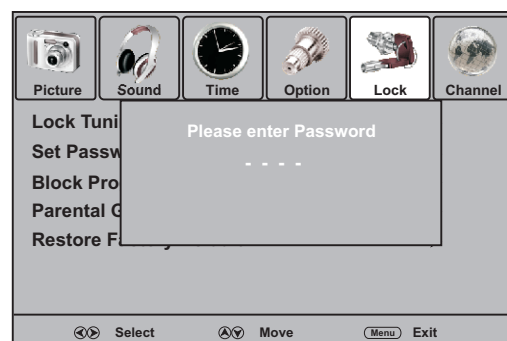

### Note

- Be sure to write down your password and retain it for future use. If you do forget the password, the unit provides a super password “2580”. Please **DO NOT** let your children know the super password.

## Block Program Setup

The Block Program function blocks any channels that you do not want to watch or that you do not want your children to watch.

- 1 Navigate to the **Lock** menu and input the correct password to access.
- 2 Use **▲** or **▼** to highlight **Block Program** item, press **▶** or **OK** to access.
- 3 Now the **Block Program** screen opens. Use **▲** or **▼** to select the channel you want to lock, then press **GREEN** button to set lock to the channel. A lock symbol appears alongside the locked channel.
- 4 Repeat the above steps for each program you wish to lock.
- 5 Press **MENU** to return to previous menu. Press **EXIT** to exit the menu screen directly. Then the Block Program comes into effect for the Locked channel.

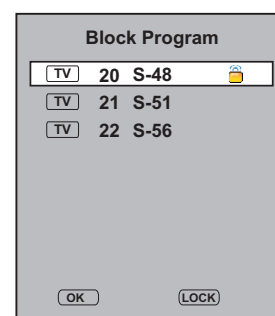
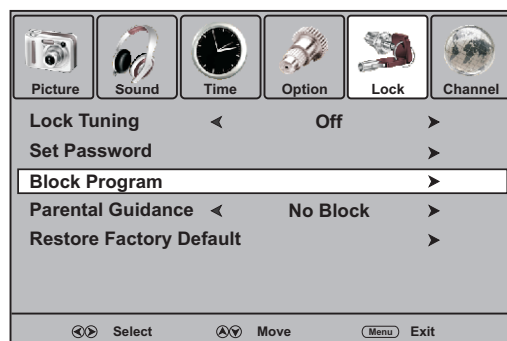

### Note

- To view a locked channel, just input the password.
- To cancel channel lock, use password to enter into the **Lock** menu, and call up **Block Program** screen, then use **GREEN** button to unlock the channel, and the lock symbol will disappear.

# Rating and Lock Setup (Continued)

## Parental Guidance Setup (DTV only)

Parental Guidance blocks programs according to their classification so that children can not view certain programs.

- 1 Navigate to the **Lock** menu and input the correct password to access.
- 2 Press **▲** or **▼** to highlight the **Parental Guidance** item.
- 3 Use **◀** or **▶** to select your desired rating.  
  
Use the “**Block All**” setting to completely block all viewing. The menu can still be accessed to unblock all programs.
- 4 Press **MENU** to return to previous menu. Press **EXIT** to exit the menu screen directly.

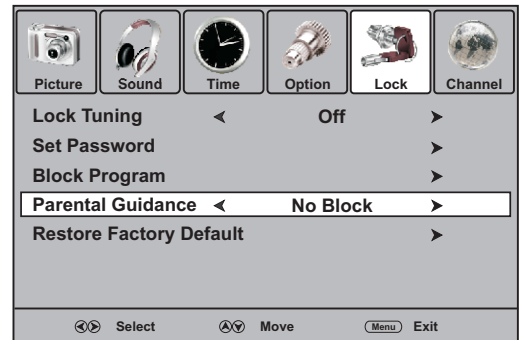

<b>G (General Audiences):</b> Content not offensive to most viewers.
<b>PG (Parental Guidance Suggested):</b> Content is such that parents may not want their children to view the program.
<b>M (Mature Audience):</b> Suitable for mature audience.
<b>MA (Mature Adult Audience):</b> May contain mature themes, profane language, graphic violence, and sexual situations.
<b>AV (Adult Audience):</b> Strong violence.
<b>R (Restricted viewing):</b> Not for children under age 17. Strong elements of sex and/or violence.

- Block All
- Block G and above
- Block PG and above
- Block M and above
- Block MA and above
- Block AV and above
- Block R and above
- No Block

## Lock Tuning Setup

Making use of Lock Tuning you can protect some TV settings from being accidentally changed.

- 1 Navigate to the **Lock** menu and input the correct password to access.
- 2 Now the **Lock Tuning** item will be highlighted automatically.
- 3 Use **◀** or **▶** to turn on or turn off the Lock Tuning. Once you turn on Lock Tuning, all items in Channel Menu can not be accessed by the user without the correct password. To cancel, use password to enter into Lock Menu and set Lock Tuning item to OFF.

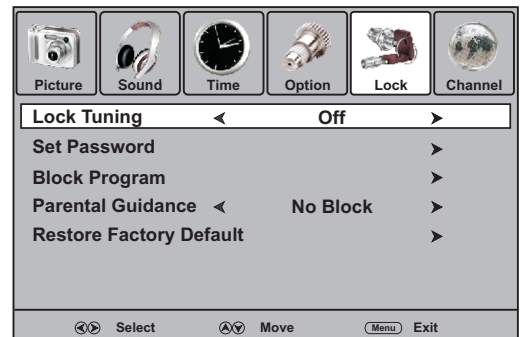

## Restoring Factory Default

Running this function to reset all settings to its original factory condition.

- 1 Navigate to the **Lock** menu and input the correct password to access.
- 2 Press **▲** or **▼** to select the **Restore Factory Default** item, press **▶** or **OK** to activate the function.
- 3 Now the screen will display a dialog box for you to confirm your operation. Use **◀** or **▶** to toggle between **YES** or **NO** item, and press **OK** to confirm your operation.



### Note

- This function will clear most of your customized settings. So make sure you do want to reset all settings to its original factory condition before you perform this operation.

# Timer Setup

## Time Zone Selection

To obtain local time, you should first set local time zone. and it depends on your local station whether has broadcast time zone information.

- 1 Press **MENU** and the main menu screen displays.
- 2 Press **◀** or **▶** to select **Time** menu, press **▼** to access.
- 3 Press **▲** or **▼** to select **Time Zone** item, and then press **◀** or **▶** to select the appropriate one.

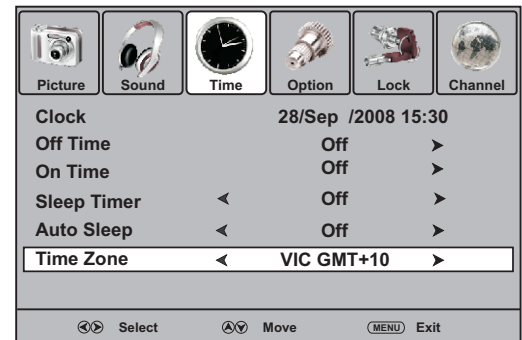

## Current Time Setup

Make use of this function can set the current time for the TV.

- 1 Navigate to the **Time** menu, press **▼** to access.
- 2 Press **▲** or **▼** to select **Clock** item, Press **▶** or **OK** to access the submenu.
- 3 Within the menu, use **▲** or **▼** to highlight the **Date, Month, Year, Hour** or **Minute** item, and use **◀** or **▶** to adjust the values. When finished, use **▲** or **▼** to select **Close** and press **OK** to confirm the setting.

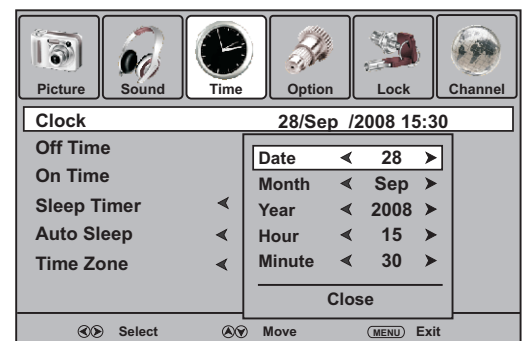

### Note

- Before setting Off timer and On timer, please set the Clock for the TV.

## On Timer Setup

With On Timer function On, the TV will automatically turn on at the preset time.

- 1 Navigate to the **Time** menu, press **▼** to access.
- 2 Press **▲** or **▼** to select **On Time** item, Press **▶** or **OK** to access the submenu.
- 3 Now the **Activate** item will be highlighted automatically, press **◀** or **▶** to select **On** . (If you want to cancel setting, please choose **Off**)
- 4 Press **▲** or **▼** to select **Hour** or **Minute** item, and press **◀** or **▶** to adjust the value.
- 5 After setting On Timer, you can press **▲**, **▼**, **◀** or **▶** to navigate through the following three options and adjust the options .

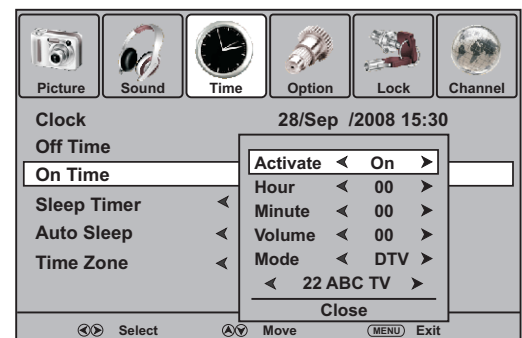

Option	Description
<b>Volume</b>	Sets desired volume for the On program.
<b>Mode</b>	Selects one source to be viewed through On timer.
<b>Program Number</b>	Selects a broadcasting program for On timer.

- 6 When finished, use **▲** or **▼** to select **Close** item and press **OK** to confirm the setting.
- 7 Press **⏻** to switch the TV to standby mode. At the preset time, the TV will auto turn on and broadcast the preset program at the preset volume.

# Timer Setup (Continued)

## Off Timer Setup

With Off Timer function On, the TV will automatically turn off at the preset time.

- 1 Navigate to the **Time** menu, press  $\blacktriangledown$  to access.
- 2 Press  $\blacktriangle$  or  $\blacktriangledown$  to select **Off Time** item, press  $\blacktriangleright$  or **OK** to access the submenu.
- 3 Now the **Activate** item will be highlighted automatically, press  $\blacktriangleleft$  or  $\blacktriangleright$  to select **On**. (If you want to cancel setting, please choose **Off**)
- 4 Press  $\blacktriangle$  or  $\blacktriangledown$  to select **Hour** or **Minute** item, and press  $\blacktriangleleft$  or  $\blacktriangleright$  to adjust the value.  
When finished, use  $\blacktriangle$  or  $\blacktriangledown$  to select **Close** and press **OK** to confirm the setting.

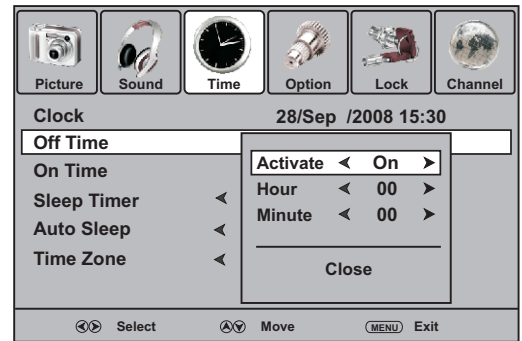

### Note

- Once you have set On timer or Off timer function, the unit will perform it everyday at the preset time.

## Sleep Timer Setup

Sleep timer lets you select the amount of time before your TV turns itself off automatically. This setting is cleared when the TV is turned off.

- 1 Navigate to the **Time** menu, press  $\blacktriangledown$  to access.
- 2 Press  $\blacktriangle$  or  $\blacktriangledown$  to select **Sleep Timer** item.
- 3 Press  $\blacktriangleleft$  or  $\blacktriangleright$  to select the amount of the time; to turn off the timer, please select **Off**.

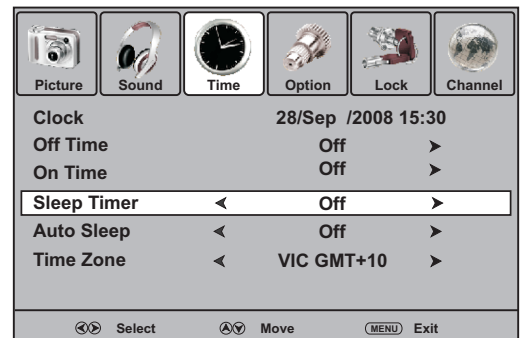

### Note

- You may directly press **SLEEP** button on the remote control to set sleep timer.
- After you have set sleep timer, when the last 30 seconds have come up, the Power Off screen will appear to remind you after how many seconds the TV will power off. You can press any button to quit.

## Auto Sleep Setup

When there is no signal input for a certain time, the unit will turn off automatically.

- 1 Navigate to the **Time** menu, press  $\blacktriangledown$  to access.
- 2 Press  $\blacktriangle$  or  $\blacktriangledown$  to select **Auto Sleep** item.
- 3 Press  $\blacktriangleleft$  or  $\blacktriangleright$  to select **On** or **Off**.

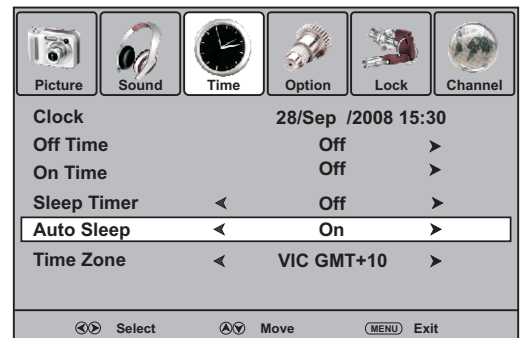

# EPG Operation

## EPG

The Electronic Programme Guide (EPG) makes it possible for users to see details about the programme they are watching, other programmes and even a schedule of the next 7 days. The information available includes the number and name of the channel, the name and type of programme, the start and end time, and a summary. Thus viewers can easily select the programmes they want to see.

### ■ Operation

- 1 Press the **EPG** button to open the EPG (Electronic Program Guide). In the EPG window (as shown on the right), several channels' current and upcoming program's information will be displayed.
- 2 Press **YELLOW** button to highlight the date bar, use **◀** or **▶** to select the proper date, and then press **YELLOW** button again to exit. Use **▲**, **▼**, **◀** or **▶** to navigate among the channels and program events, and press **INFO** button to get more detailed information (if available) about the programme you choose. If you want to switch between TV and Radio programmes, please press **TV/Radio**.
- 3 Press **OK** to tune to the channel you have selected. To clear the EPG window, press **EXIT** button or **EPG** button.

DTV	28 Jul	
	15:00	16:00
7 7 Digital	BLUE HEELERS	No information
70 7 HD Digital	BLUE HEELERS	No information
71 7 Digital 1	BLUE HEELERS	No information
72 7 Digital 2	BLUE HEELERS	No information
73 7 Digital 3	BLUE HEELERS	No information

### Note

- The EPG will only work when you are receiving digital channels.
- To enable EPG to work properly, it is suggested to set the appropriate time zone.

# Teletext & Subtitle

## Teletext

### ■ What Is Teletext?

Your System receives Teletext signals broadcast by a TV network, and decodes them into graphical format for viewing. News, weather and sports information, stock exchange prices and programme previews are among the many services available.

### ■ To Turn On/Off Teletext

- Select a TV channel providing the Teletext program.
- Press **TTX** button to display the teletext.
- Press **TTX** button again to switch back to TV screen.

### ■ Teletext control button list

- **▲/▼** button  
Used to scroll page upward or downward.
- **0–9** button  
Directly select any page by using 0–9.
- **Colored** buttons (**RED/GREEN/YELLOW/BLUE**)  
Colored areas are displayed at the bottom of the screen. The 4 colored buttons are used to access the items or corresponding pages.
- **Hold** button  
Certain pages contain sub-pages which are automatically displayed successively. This button is used to stop or resume sub-page acquisition.
- **Reveal** button  
Press the button to reveal the concealed information such as games solutions. Press the button again to hide the information.
- **Size** button  
Press this button several times to display the upper, then the lower part of the screen and then return to the normal size teletext page.
- **Index** button  
In teletext mode, press this button to display the index page.
- **Mix** button  
Press the button to display the Teletext on the screen with transparent background while viewing the TV program simultaneously.
- **Update** button  
Press the button to view the updated teletext page.

## Subtitle

- When watching digital programs, press **Subtitle** button to display the subtitle.
  - 1 If the program has subtitle, simply press **Subtitle** button to display subtitle.
  - 2 Press **Subtitle** again to cancel the subtitle.
- When watching analog programs, press this button to display the teletext subpage.





# Screen Setup for D-SUB(PC) Mode

Before adjusting the screen, make sure that you select the correct source (D-SUB).

## Screen Setup

- 1 Press **MENU** and the main menu screen displays.
- 2 Press **◀** or **▶** to select the **Picture** menu, press **▼** to access the menu.
- 3 Within the menu, press **▲** or **▼** to scroll through the page upward or downward until you select the **Screen** item, then press **▶** or **OK** to access.
- 4 Press **▲**, **▼**, **◀**, **▶** to navigate through the options or adjust an option. To confirm, press **OK**.
- 5 Press **MENU** to return to previous menu. Press **EXIT** to exit the menu screen directly.

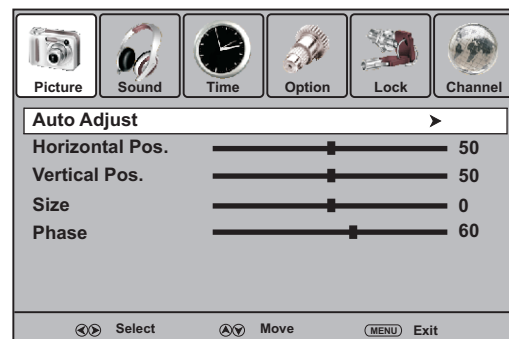
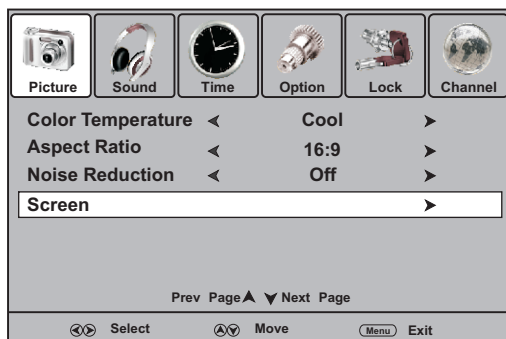

Option	Description
<b>Auto adjust</b>	Selects and activates to start auto adjustment. The set automatically adjusts the image settings, such as position and phase.
<b>Horizontal Position</b>	Moves the image on the screen left or right.
<b>Vertical Position</b>	Moves the image on the screen up or down.
<b>Size</b>	Adjust the horizontal width of the image on the screen.
<b>Phase</b>	Improves the focusing of a stable image.

# Troubleshooting

---

If, after reading these operating instructions, you have additional questions related to the use of your television, please call the services center in your local area.

Before calling service, please check the symptoms and follow suggested solutions.

## Remote Control

<i>Problem</i>	<i>Possible Solutions</i>
Remote control does not operate	<ul style="list-style-type: none"><li>● The batteries could be weak. Replace the batteries.</li><li>● Check the orientation of the batteries.</li><li>● Make sure the power cord is plugged in.</li></ul>

---

## Video and Audio

<i>Problem</i>	<i>Possible Solutions</i>
No picture (screen not lit), No sound	<ul style="list-style-type: none"><li>● Make sure the power cord is plugged in.</li><li>● Press POWER on the TV or on the remote control.</li><li>● Try another channel; it could be station trouble.</li></ul>
Dark, poor or no picture (Screen lit), good sound	<ul style="list-style-type: none"><li>● Select a proper picture mode.</li><li>● Adjust the brightness in the video setting.</li><li>● Check the antenna connections.</li></ul>
No color/dark picture/color is not correct	<ul style="list-style-type: none"><li>● Adjust the color saturation in the video setting.</li></ul>
Only snow and noise appear on the screen	<ul style="list-style-type: none"><li>● Check the antenna connections.</li><li>● Try another channel; it could be station trouble.</li></ul>
Dotted lines or stripes	<ul style="list-style-type: none"><li>● Adjust the antenna.</li><li>● Move the TV away from noise sources such as cars, neon signs, or hair dryers.</li></ul>
Double images	<ul style="list-style-type: none"><li>● Using a highly directional outdoor antenna or a cable may solve the problem.</li></ul>
Good picture, no sound	<ul style="list-style-type: none"><li>● The sound may be muted. Press MUTE again to cancel.</li><li>● Make sure the stereo mode is set to stereo or mono.</li></ul>
Audio noise	<ul style="list-style-type: none"><li>● Communication problems may occur if infrared communication equipment (e.g., infrared cordless headphones) is used near the TV. Move the infrared communication equipment away from the TV until the noise is eliminated.</li></ul>

---

# Troubleshooting

---

## General

Problem	Possible Solutions
One or some channels can't be displayed	<ul style="list-style-type: none"><li>● These channels may be locked. Please unlock them (see &lt;Rating and Lock Setup&gt; section).</li><li>● These channels may be set skipped in the channel list. You may set it to not skipped or select them with 0-9 number buttons.</li></ul>
Lost password	<ul style="list-style-type: none"><li>● You may use the super password (2580).</li></ul>
Some items can't be accessed	<ul style="list-style-type: none"><li>● If a setting option appears in gray, this indicates that the settings option is unavailable in current input mode.</li></ul>
TV cabinet creaks	<ul style="list-style-type: none"><li>● When the TV is in use, there is a natural rise in temperature, causing the cabinet to expand or contract and may be accompanied by a slight creaking noise. This is not a malfunction.</li></ul>
Some settings (such as volume setting, etc.) may not be memorized when the TV loses power or you press main Power Switch to turn off the TV.	<ul style="list-style-type: none"><li>● After you make some settings or adjustments, and within 30 seconds you turn off the TV by main Power Switch or the TV loses power, then the settings you have made within 30 seconds may not be memorized. But you can use Power button to switch the TV to standby mode before cutting off the power, then the settings can be memorized.</li></ul>
Control buttons do not operate	<ul style="list-style-type: none"><li>● Disconnect the power cord and wait for a few seconds. Then re-plug the power cord and turn on the unit again.</li></ul>

### Note

*If your problem is not solved, turn your unit off and then on again.*

### **Cautions:**

*Never attempt to repair a defective TV yourself.*

# Specifications

---

Type:	PDP TV
Display Size diagonal:	42"
Power Supply:	AC 100-240V 50/60Hz
Power Consumption:	350W
Dimensions(mm):	1045 (W) x 763(H) x 326(D)
Unit Weight(kg):	31
TV System:	Analogue: CCIR(PAL-B/G, NTSC(AV)) Digital: DVB-T(2K/8K OFDM)

## Note

- Design and specifications are subject to change without notice.

PALSONIC CORPORATION PTY LTD  
1 JOYNTON AVENUE  
WATERLOO NSW 2017 AUSTRALIA  
TEL:(02)9313 7111  
FAX:(02)9313 7555

**PALSONIC CUSTOMER SERVICE  
TELEPHONE  
AUSTRALIA:1300 657 888**

**5944034820  
Ver 1.0**

## Free Manuals Download Website

<http://myh66.com>

<http://usermanuals.us>

<http://www.somanuals.com>

<http://www.4manuals.cc>

<http://www.manual-lib.com>

<http://www.404manual.com>

<http://www.luxmanual.com>

<http://aubethermostatmanual.com>

Golf course search by state

<http://golfingnear.com>

Email search by domain

<http://emailbydomain.com>

Auto manuals search

<http://auto.somanuals.com>

TV manuals search

<http://tv.somanuals.com>