

OWNER'S MANUAL

Palsonic

**76CM CORDLESS REMOTE LCD TV/MONITOR
MODEL: TFTV-760**



Type Tested
Electrical
Safety

AS/NZS 3250 Lic 3250
Standards Australia
APP No: N17339

PALSONIC CORPORATION PTY LTD
1 JOYNTON AVENUE
WATERLOO NSW 2017 AUSTRALIA
TEL: (02) 9313 7111
FAX: (02) 9313 7555
www.palsonic.com.au

**PALSONIC CUSTOMER SERVICE
TELEPHONE
AUSTRALIA: 1300 657 888**

Contents

Congratulations on your purchase of this **Palsonic LCD TV/MONITOR**.

We recommend that you thoroughly read this manual before use to fully enjoy the many functions and excellent effects of this LCD TV/MONITOR.

Retain this manual in an easily accessible location for future reference.

Note: Screen displays and illustrations in this manual may differ from the actual ones for better visibility.

Contents	1	Channel edit	18
Important Safety Cautions	2	Channel Select	19
Identification of controls	4	Picture Adjustment	20
Front	4	Sound	21
Back	5	System Setting	22
Remote control	6	To enter into SETUP menu	22
Battery installation	7	Colour system	22
Effective remote range	7	Sound System	22
Installation	8	Setting OSD Language	22
Antenna installation/		Setting OSD position	23
Adaptor connection	8	Setting Scaler mode	23
Connecting video/audio		Setting OSD Background	23
equipment	9	Timer	24
Connecting DVD player and		Use SLP button	24
speaker	10	Use CLK button	24
Connecting YPbPr terminals	11	Adjustment in YPbPr mode	25
Connecting VGA interface	12	To enter into YPbPr mode	25
Elevation adjustment	13	Adjusting picture	25
Menu introduction	14	Adjusting horizontal/vertical	
Turning On/Off	16	position	25
Turning On	16	Adjustment in PC mode	26
Turning Off	16	To enter into PC mode	26
Selecting input signal	16	PC signal format	26
Channel Preset	17	Use AUTO ADJ. button ...	26
To enter into Channel		Adjusting bright and contrast	27
Setting menu	17	Adjusting phase and frequency ..	27
Auto Search	17	Adjusting Colour temperature	27
Manual Search	17	Trouble Shooting	28
Fine tuning	17	Specifications	29
Channel Skipping	18		

Important Safety Cautions

When any unusual situation occurs, turn off the power supply at once and remove the plug from the wall outlet. Contact a qualified service department in your local area.

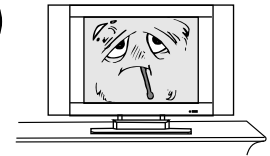

Water and moisture - Do not use this product near water - for example, near a bathtub, washbowl, kitchen sink, or laundry tub, in a wet basement, or near a swimming pool, and the like. Do not use immediately after moving from a low temperature to high temperature environment, as this causes condensation, which may result in fire, electric shock, or other hazards.



Heat sources - Keep the product away from heat sources such as radiators heaters, stoves other heat generating products (including amplifiers).
requirement of environment temperature;
-20°C~50°C for storage; 0°C~40°C for working.

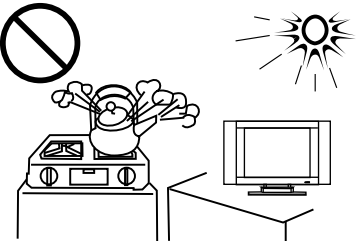

The vents and other openings in the cabinet are designed for ventilation. Do not cover or block these vents and openings since insufficient ventilation can cause overheating and/or shorten the life of the product.

Do not place the product on a bed, sofa, rug or other similar surface, since they can block ventilation openings.

This product is not designed for built-in installation; do not place the product in an enclosed place such as a bookcase or rack, unless proper ventilation is provided or the the manufacturer's instructions are followed.

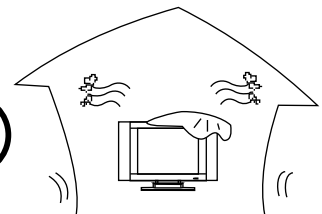

Unplug this product from the wall outlet before cleaning. Do not use liquid cleaners or aerosol cleaners. Use a damp cloth for cleaning.

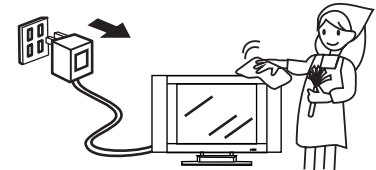

Do not place the product on an unstable trolley, stand, tripod or table. Placing the product on an unstable base can cause the product to fall, resulting in serious personal injuries as well as damage to the product. Use only a trolley, stand, tripod, and bracket or table recommended by the manufacturer or sold with the product.

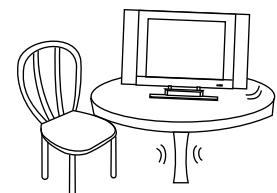

⚠ This TV set can be operated on a power of ~240V 50Hz. You must not use a power supply of any other type.

When relocating the product placed on a trolley, it must be moved with the utmost care. Sudden stops, excessive force and uneven floor surfaces can cause the product to fall from the trolley.



The power cords must be routed properly to prevent people from stepping on them or objects from resting on them. Check the cords at the plugs and product. Power supply cords should be routed so that they are not likely to be walked on or snagged by items placed upon or against them. Pay particular attention to cords at doors, plugs, receptacles, and the point where they exit from the product. If the power cord or the plug is damaged contact a qualified service department for service.

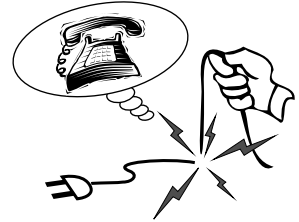

Do not overload wall outlets, extension cords, or convenience receptacles on other equipment as this can result in a risk of fire or electric shock.

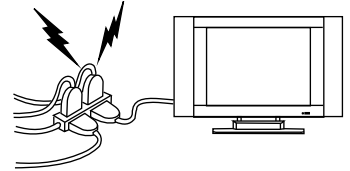

High Voltage exists in this TV set. Do not remove the cover. In case the product needs replacement parts, make sure that the service person uses replacement parts specified by the manufacturer, or those with the same characteristics and performance as the original parts. Use of unauthorised parts can result in fire, electric shock and/or other danger.

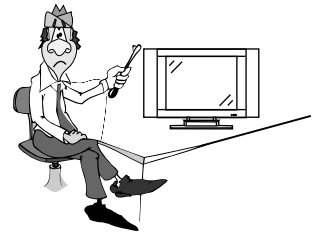

The LCD panel used in this product is made of glass. Therefore, it can break when the product is dropped or impacted upon by other objects. Be careful not to be injured by broken glass pieces in case the LCD panel breaks.

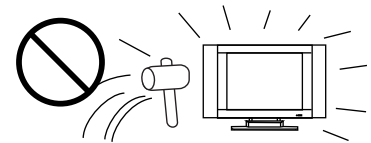

Don't try to push anything into the cabinet or place any vessel with water on the TV set.

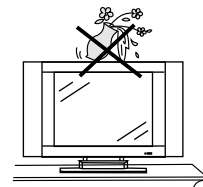

For added protection for this television equipment during a lightning storm, or when it is left unattended and unused for long periods of time, unplug it from the wall outlet and disconnect the antenna. This will prevent damage to the equipment due to lightning and power-line surges.

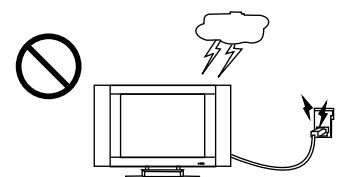

Identification of controls

Front

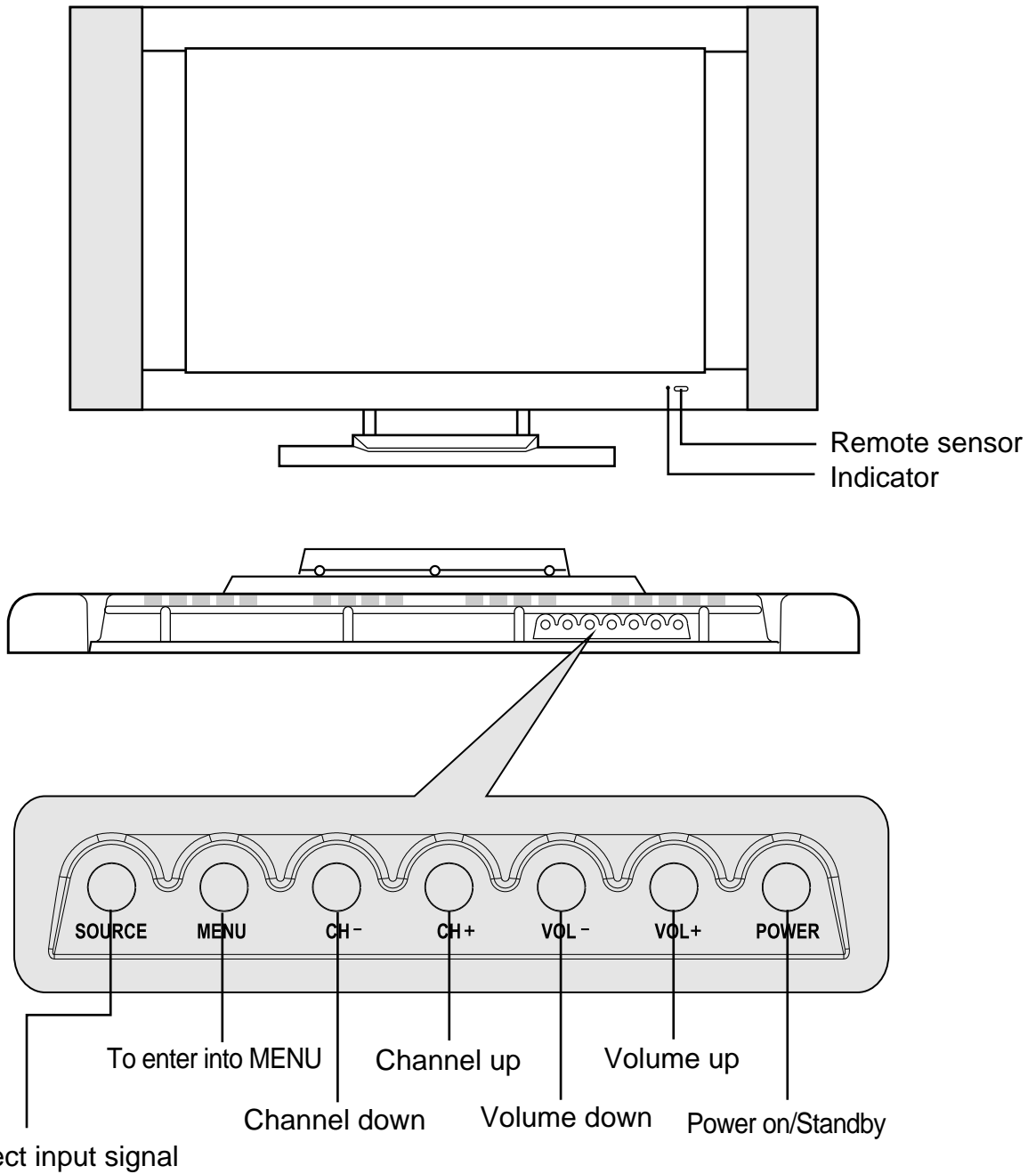

Back

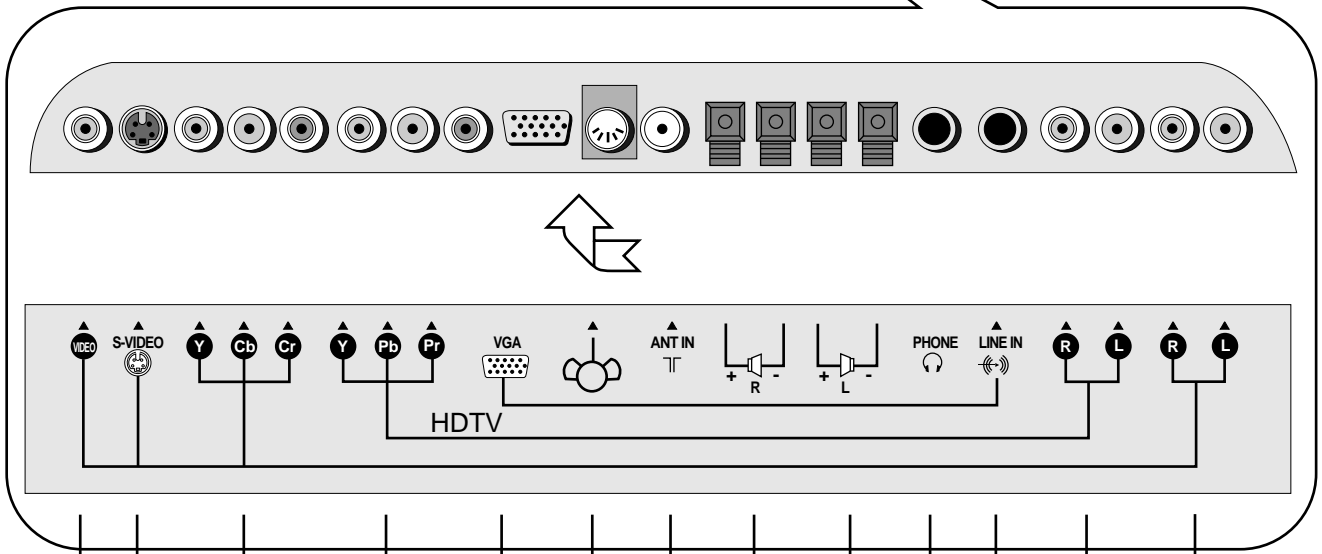
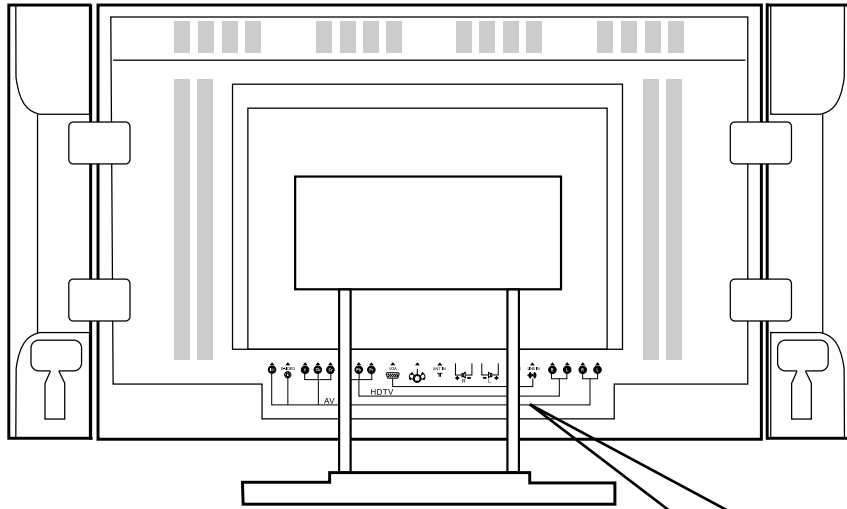

Video input

S-video input

DVD inputs

HDTV YPbPr inputs

VGA input

DC input

Antenna input

Speaker outputs

Earphone jack

PC audio line in

HDTV Audio inputs

Audio inputs

Identification of controls (continued)

Remote Control

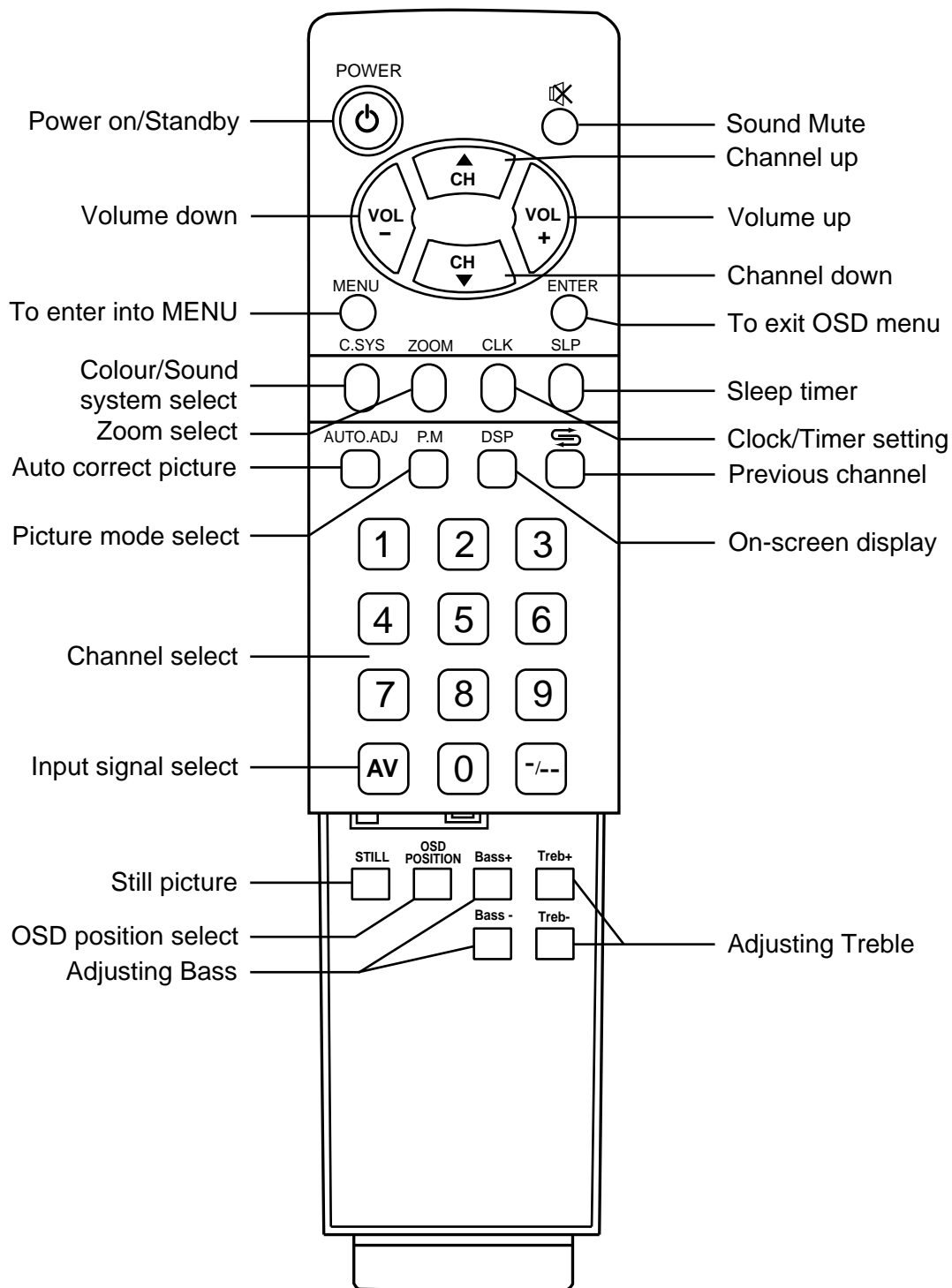

Battery installation

Please install the batteries before using the remote control unit.

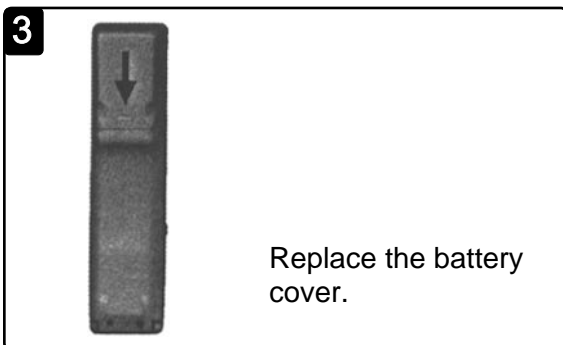
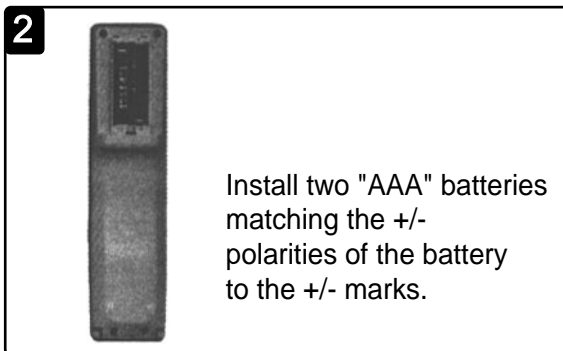
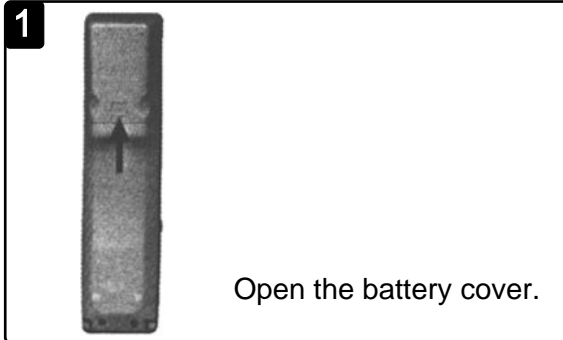

! Notes:

- When the remote control will not be used for a long period of time or when the batteries are worn out, remove the batteries.
- Do not throw the batteries into a fire. Dispose of used batteries in the specified manner.
- Do not drop, dampen or disassemble the remote control.

Effective remote range

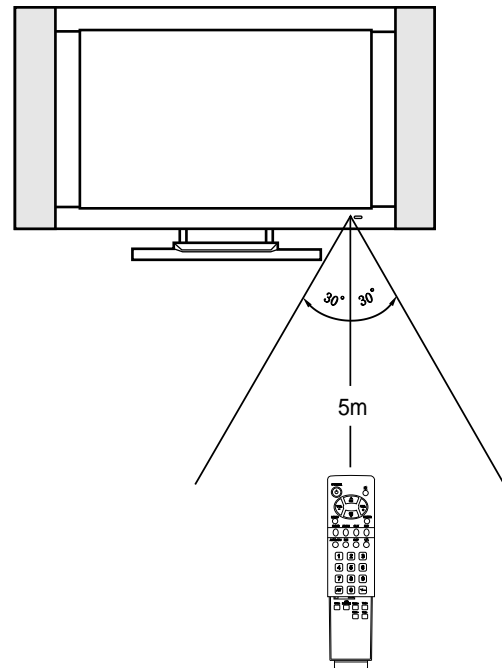

! Notes:

- There should be no obstacle between the TV and the transmitter.
- Use the remote control within the effective range as the above figure.
- If the remote control does not work, please check whether the batteries are exhausted or the polarity is wrong.
- When direct sunlight, and incandescent lamp, fluorescent lamp or any other strong light shines on the REMOTE SENSOR of the TV the remote operation may be unstable.

Installation

Antenna installation/Adaptor connection

Before using this equipment, please connect the AC power adaptor correctly. Optimum reception of colour requires a good signal and will generally mean that an outdoor aerial must be used. The exact type and position of the aerial will depend upon your particular area.

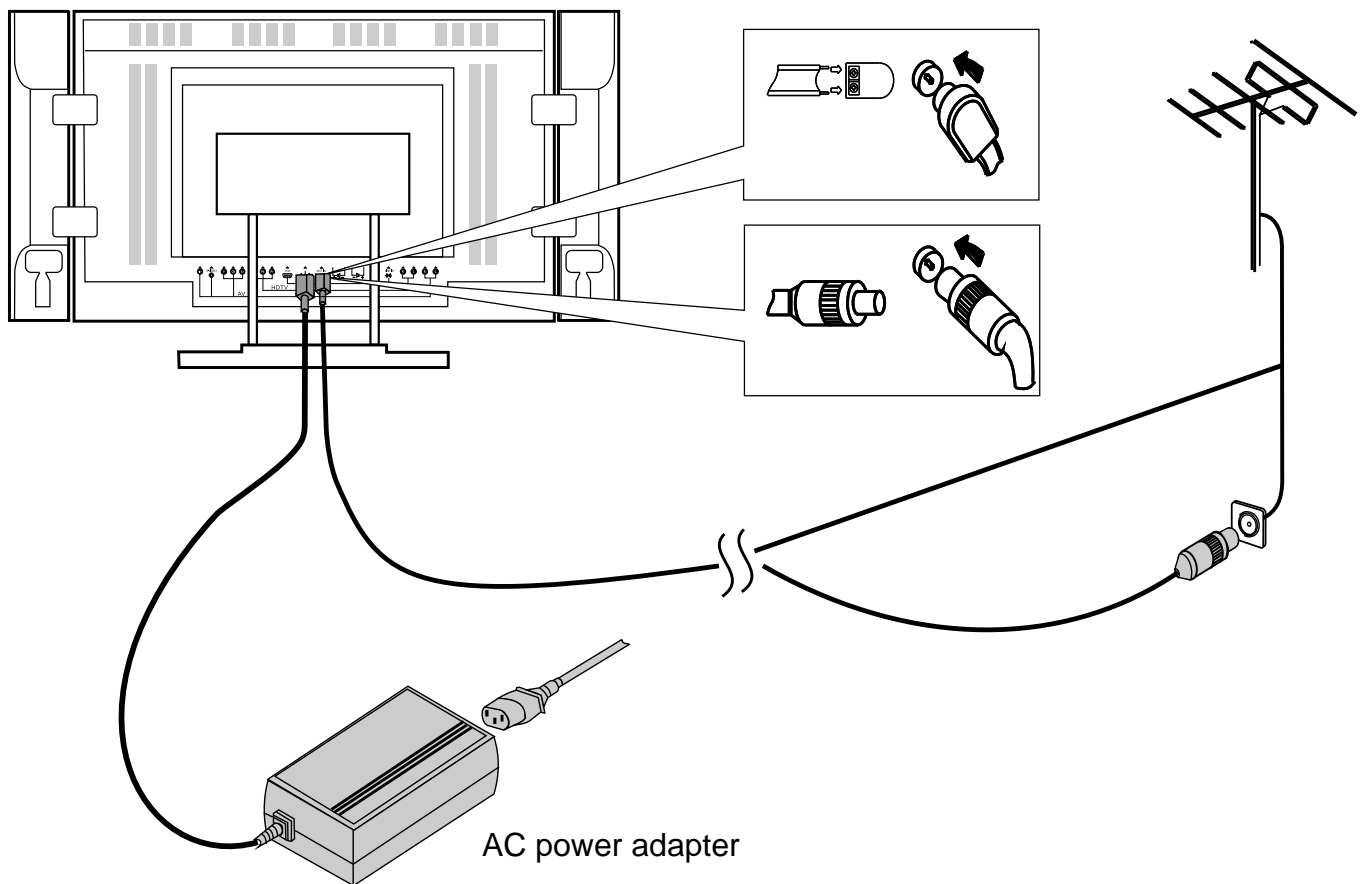

⚠ Notes:

Turn off the power firstly when you connect a outdoor antenna to the Antenna input terminal. When installing an outside antenna system, extreme care should be taken to keep from touching power lines or circuits as contact with them might be fatal. In thunder and lightning weather, please disconnect the outdoor antenna to avoid thunder/lighting strike.

Connecting video/audio equipment

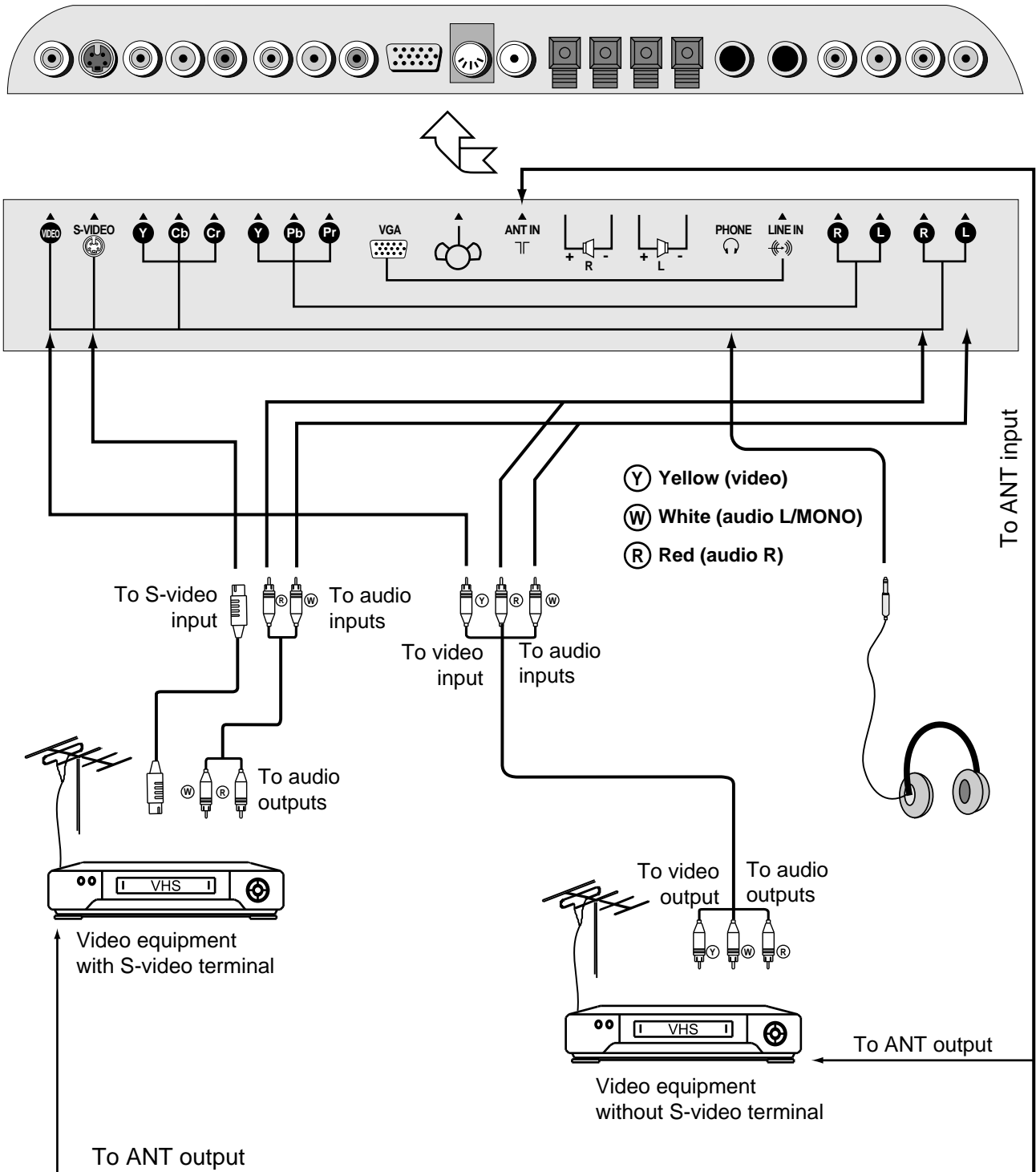

Installation (continued)

Connecting DVD Player and speakers

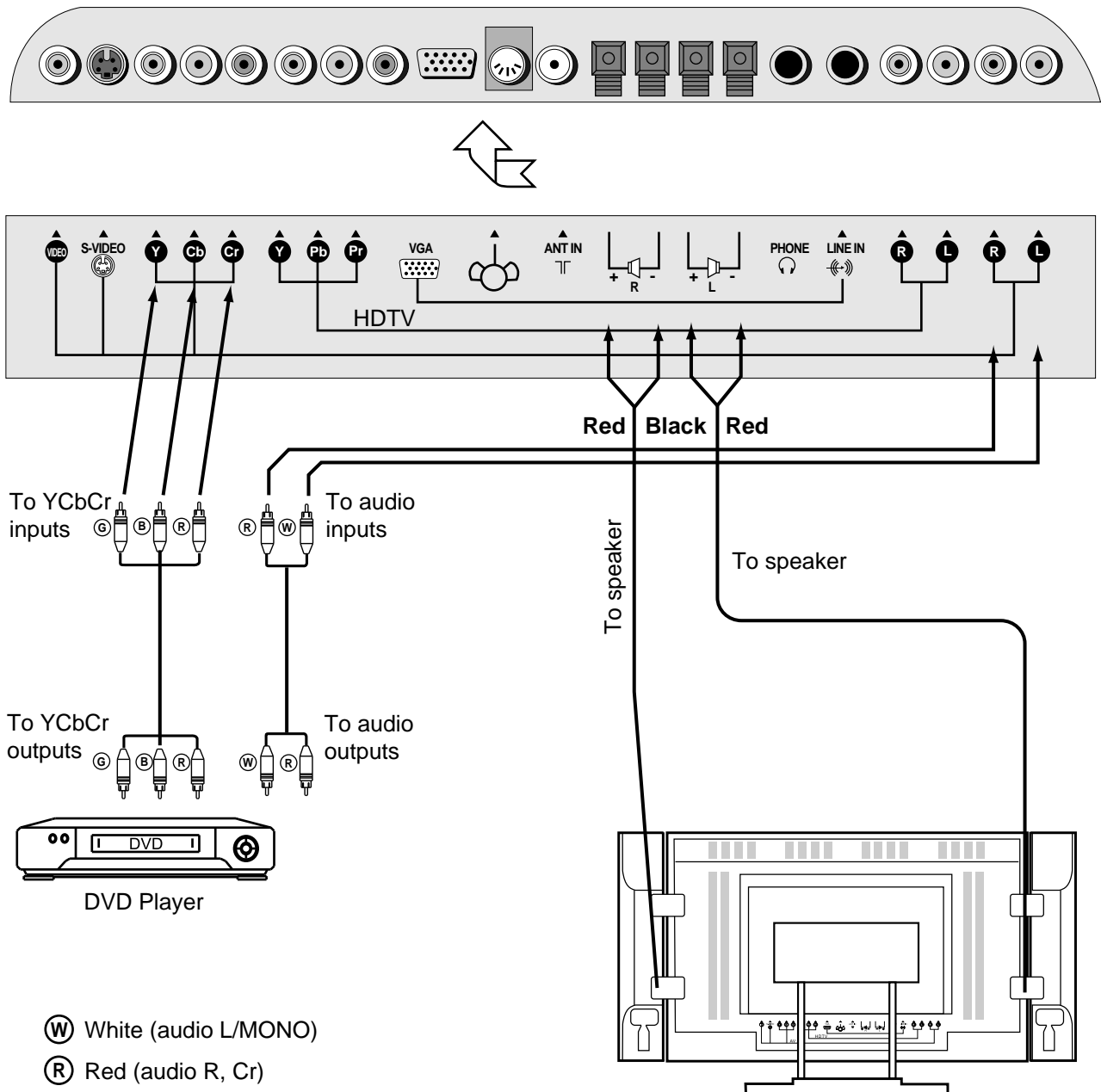

Connecting YPbPr terminals

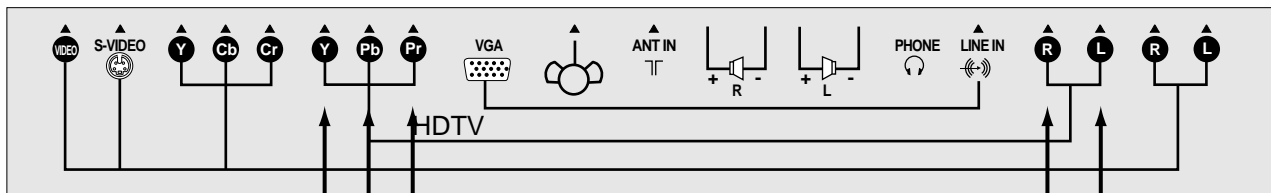
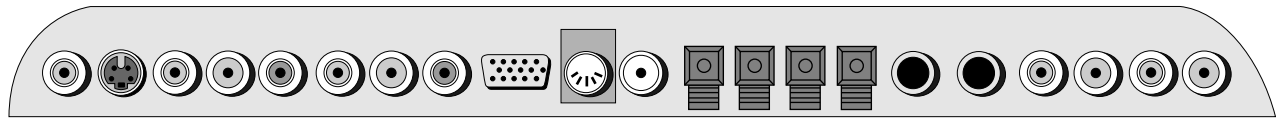

To YPbPr inputs

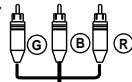

To audio inputs



(W) White (audio L/MONO)

(R) Red (audio R, Pr)

(G) Green (Y)

(B) Blue (Pb)

To YPbPr outputs

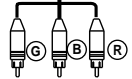

To audio outputs

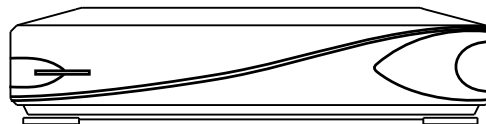

SET TOP BOX
(Or other equipment with YPbPr output terminals)

Installation (continued)

Connecting VGA interface

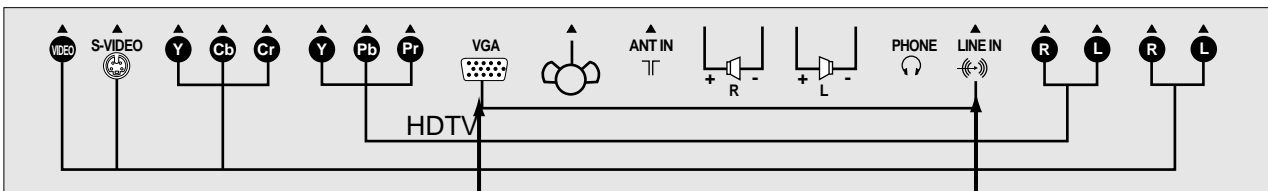
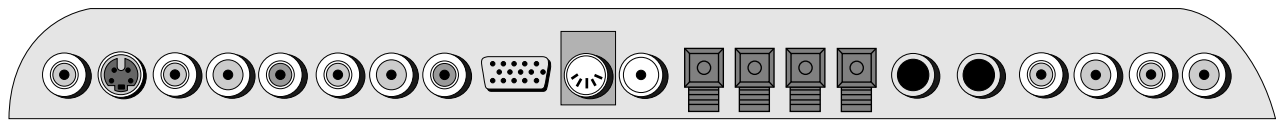

To VGA input interface

To LINE in

Equipment with
VGA output interface

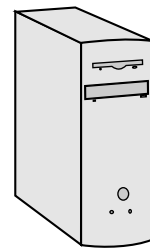

To LINE out

To VGA output
interface

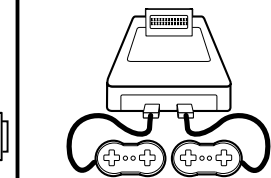

Elevation adjustment

You can adjust the angle of the LCD TV/Monitor as follows.
The elevation can be adjusted from -5° to $+10^{\circ}$.

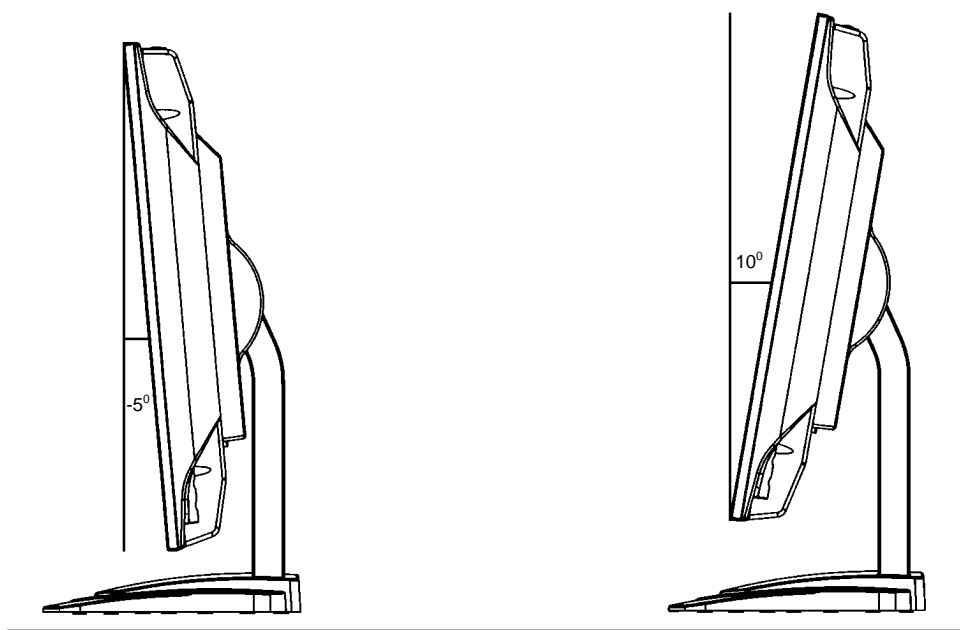

Menu Introduction

There are four pages of **MENU** in TV, PC and YPbPr mode. In **MENU** operations, the **CH▲/▼** buttons are used to select item upwards or downwards; the **VOL+/-** buttons are used to adjust or confirm selected item.

Press **MENU** button in TV mode

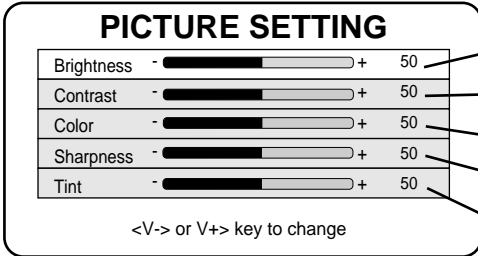

- To adjust the picture's brightness.
- To adjust the picture's contrast.
- To adjust the picture's colour saturation.
- To adjust the picture's sharpness.
- To adjust the picture's skin colour. (This item is available only in NTSC).

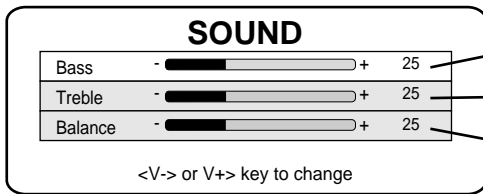

- To adjust the Bass.
- To adjust the Treble.
- To adjust the Balance.

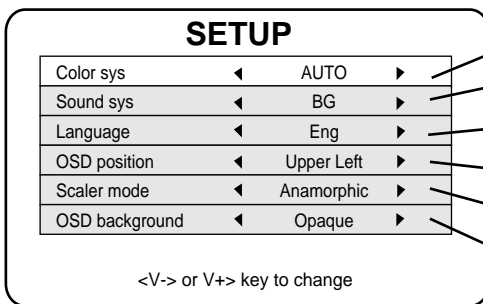

- To adjust colour system.
- To adjust sound system.
- To select OSD menu language.
- To select OSD menu position.
- To select screen aspect ratio.
- To set OSD background.

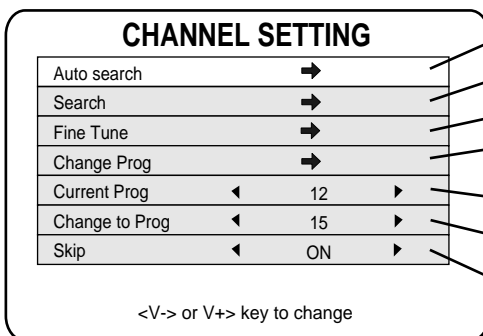

- To start auto search.
- To enter into channel search menu.
- To enter into fine tuning menu.
- To exchange current channel with the selected target channel.
- To display current channel number.
- To select a target channel to exchange with current channel.
- To skip or unskip, current channel.

Press **MENU** button in PC mode

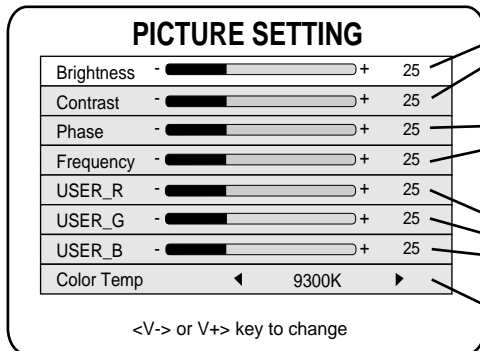

To adjust picture's brightness and contrast in PC mode. (not affect picture in TV or AV mode)

If the best picture can not be obtained after many times of auto correction, you can adjust these two items to obtain the best picture.

Only when the "Color temp" is set to "User", these three items are adjustable.

To adjust colour temperature between 9300K, 7300K, 6500K, and User.

Press **MENU** button

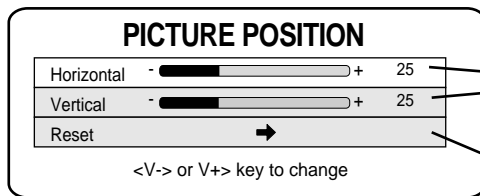

When the VGA input signal is nonstandard, adjust these two items until proper picture position is obtained.

To reset to factory settings.

Press **MENU** button

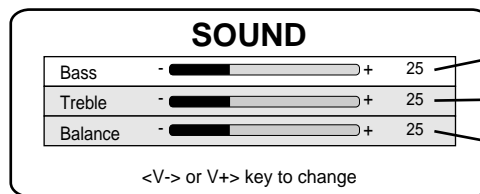

To adjust the Bass.

To adjust the Treble.

To adjust the Balance.

Press **MENU** button

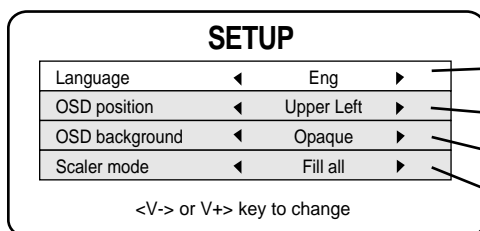

To select OSD menu language.

To select OSD menu position.

To set OSD background.

To select screen aspect ratio.

Turning On/Off

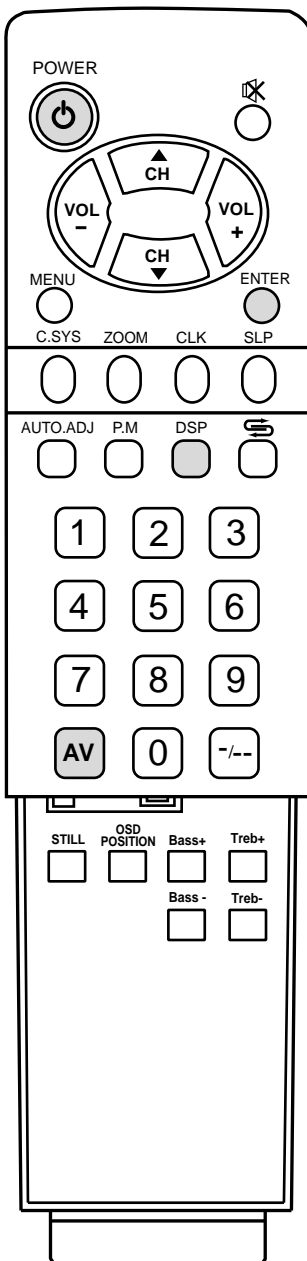
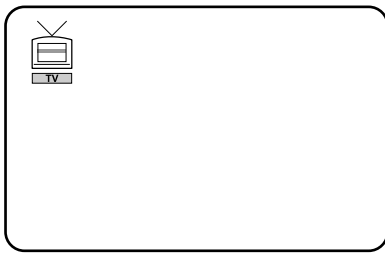

Turning On

1. Insert the output plug of the AC power adaptor into the DC power input of the unit.
2. Press the power switch on AC power adaptor and the red indicator lights up, the TV/Monitor is in STANDBY mode.
3. Press the **POWER** button on the unit's control panel or the button  on the remote control to turn on.

! Notes:

In TV mode, when there is no TV signal input for about 15 minutes, the set goes to STANDBY automatically.

Turning Off

1. If you want to turn off the power completely, press the power switch on the AC adaptor.
2. If you want to turn off temporarily, press the **POWER** button on the unit's control panel or the  button on the remote control, the set goes to STANDBY and the indicator turns to red.

! Notes:

This TV set can automatically turn off by:

1. When there is no TV signal input for about 15 minutes;
2. Sleep timer;
3. Off timer.

Selecting input signal

1. Press the **AV** button on the remote control or **SOURCE** button on the set's panel to select input mode. You can select **TV**, **AV**, **S-video**, **YCbCr**, **YPbPr** or **PC**.
2. If you want to go to TV mode, press **AV** button repeatedly to select TV mode.
3. Press **DSP** button, the screen display current mode. Press **ENTER** to cancel OSD.

Channel Preset

CHANNEL SETTING		
Auto search	→	
Search	→	
Fine Tune	→	
Change Prog	→	
Current Prog	◀ 12 ▶	
Change to Prog	◀ 15 ▶	
Skip	◀ ON ▶	

<V-> or V+> key to change

To enter into CHANNEL SETTING menu

1. Press **MENU** button repeatedly to display **CHANNEL SETTING** menu.
2. Press **CH▲** or **CH▼** button to select item.
3. Press **VOL+** or **VOL-** button to confirm or adjust selected item.

Auto Search

Please enter into **CHANNEL SETTING** menu and select **Auto Search** item.

Press **VOL-** or **VOL+** button to start Auto Search and all active programs will be memorised.

During the process of Auto Search, pressing **MENU** button will stop Auto Search.

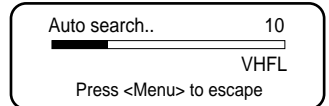

Notes:

Please confirm the sound system is correct according to your area before Auto Searching.

Manual Search

Use manual search function if desired channels cannot be preset or if you would like to preset channels to specific position numbers one by one.

Use **0~9** digit buttons or **CH▲/▼** buttons to select a position number firstly, then enter into **CHANNEL SETTING** menu and select **Search** item. Press **VOL+** button to enter Channel Search sub-menu, then press **VOL+** or **VOL-** to start manual search.

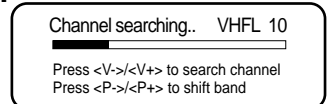

Press **MENU** button can exit Channel Search sub-menu.

Fine Tuning

In area of inferior broadcast conditions where adjustment is necessary for a better picture and sound, use Fine tuning.

Use **0~9** digit buttons or **CH▲/▼** buttons to select the desired channel, then enter into **CHANNEL SETTING** menu and select **Fine tune** item. Press **VOL+** button to enter into Fine tuning sub-menu, then press and hold **VOL+** or **VOL-** to start Fine tuning.

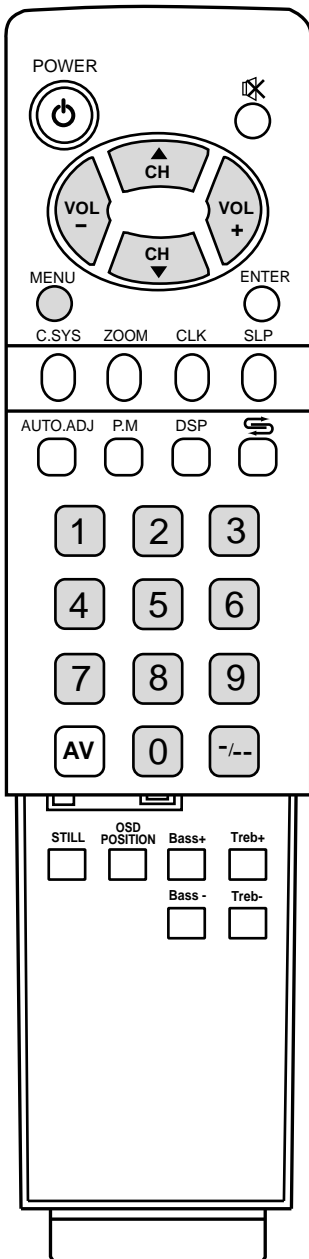
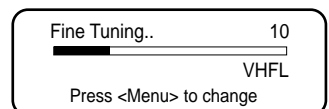

Channel Preset (continued)

CHANNEL SETTING		
Auto search	→	
Search	→	
Fine Tune	→	
Change Prog	→	
Current Prog	◀ 12 ▶	
Change to Prog	◀ 15 ▶	
Skip	◀ ON ▶	

<V-> or V+> key to change

Channel Skipping

You can skip unnecessary channels by using Skip function when you browse program by **CH ▲/▼** buttons.

Use **0~9** digit buttons or **CH ▲/▼** buttons to select a unwanted channel firstly, then enter into **CHANNEL SETTING** menu and select Skip item. Press **VOL+/-** button to select **ON** to skip this channel. Now this channel will be skipped when you browse channels with **CH ▲/▼** button.

To restore the skipped channel, please select the skipped channel with **0~9** digit buttons and then enter the **CHANNEL SETTING** menu, select **Skip** item and press **VOL+/-** to set **Skip** to **OFF**.

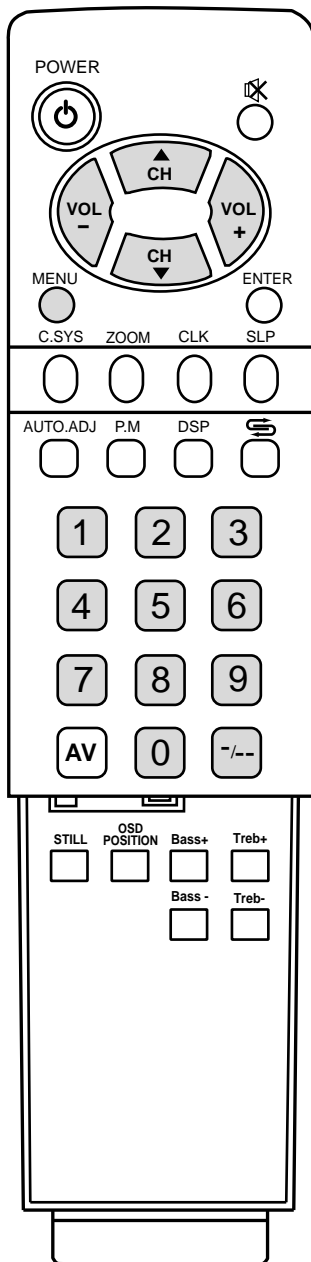

Channel Edit

After Auto Channel Preset, this function is for you to edit the order of programs conveniently according to your favourite.

Please enter into **CHANNEL SETTING** menu and select **Change to Prog** item by **CH ▲/▼** buttons, press **VOL+/-** button to select a target channel to exchange with current channel. Then select **Change Prog** item and press **VOL+/-** to confirm. Now the program in current channel number exchanges with the program in the target channel number.

CHANNEL SETTING		
Auto search	→	
Search	→	
Fine Tune	→	
Change Prog	→	
Current Prog	◀ 12 ▶	
Change to Prog	◀ 15 ▶	
Skip	◀ ON ▶	

<V-> or V+> key to change

Channel Select



Use 0~9 digit buttons and -/-- button

- ◆ Use **0~9** digit buttons to select one-digit channel number.

Press -/-- button to display "-".

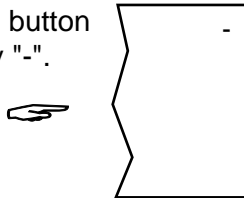

Press 0-9 direct channel selector.

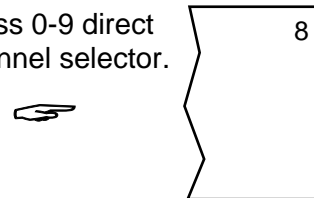

- ◆ To select two-digit channel:

Press -/-- button repeatedly to display "--".

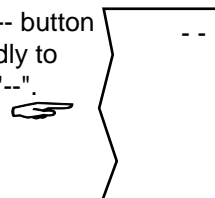

Press 1-9 buttons.

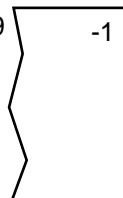

Press 0-9 buttons.

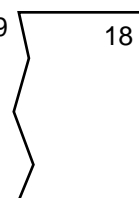

- ◆ To select three-digit channel:

Press -/-- button repeatedly to display "---".

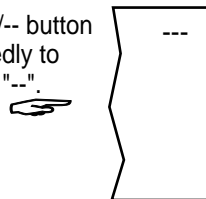

Press 1-9 buttons.



Press 0-9 buttons.



Press 0-9 buttons.

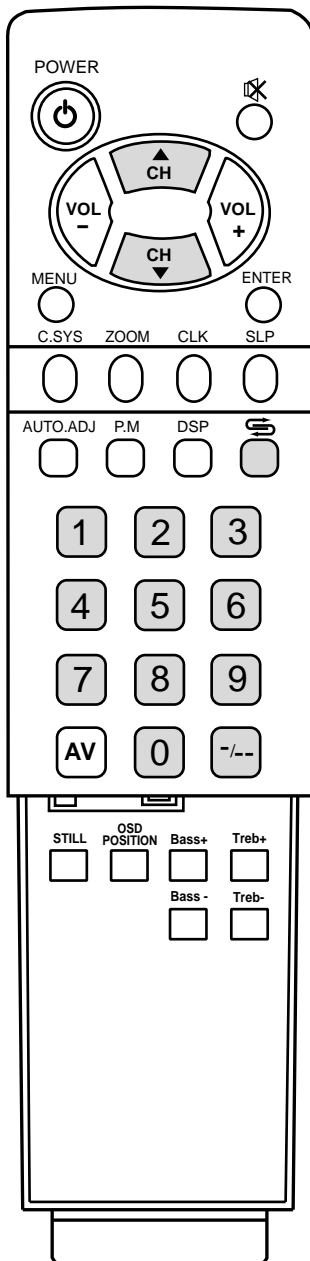
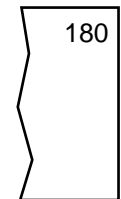

Using CH ▲ / ▼ button

Press **CH ▲** button, the channel number increases;
Press **CH ▼** button, the channel number decreases.

Use previous channel button

Press this button to switch between the current channel and previous channel.

Picture Adjustment

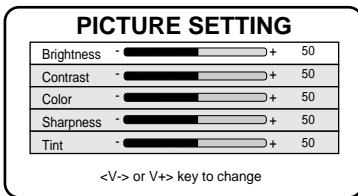

Adjusting picture

1. Press **MENU** button to display **PICTURE SETTING** menu.
2. Press **CH ▲/▼** button to select item.
3. Press **VOL+/-** button to adjust the selected item.

Item	VOL-	VOL+
Bright	darker	lighter
Contrast	weaker	stronger
Saturation	paler	deeper
Sharpness	softer	sharper
Tint*	purplish	greenish

* Note: The item **Tint** is for NTSC only.

The adjusted settings are stored in the **User mode**. There are three preset picture modes and one User-set picture mode. Press the **P.M** button to select a picture mode according to your favourites.

4. Press **P.M** button to select picture mode.
You can quickly select picture mode by **P.M** button. There are four picture mode: **Bright**, **Standard**, **Mild** and **User mode**.

Using STILL button

You can still current screen picture by pressing **STILL** button on the remote. Press this button again to resume.

Using AUTO.ADJ button

When wrong picture identification occurs, you can use **AUTO.ADJ** button on the remote to obtain a correct picture.

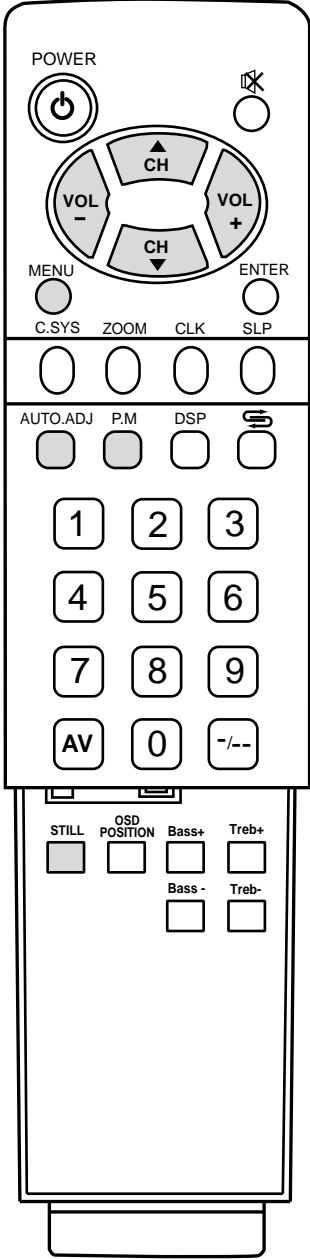

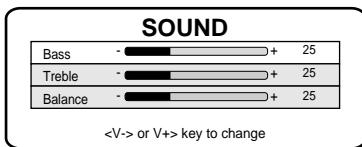

Adjusting Sound

1. Press **MENU** button repeatedly to display **SOUND** menu.
2. Press **CH ▲/▼** button to select item.
3. Press **VOL+/-** button to adjust the selected item.

Item	VOL-	VOL+
Bass	weaker	stronger
Treble	weaker	stronger
Balance	decreases the right channel	decreases the left channel

Notes:

You can quickly adjust Bass and Treble by using **Bass+/Bass-** and **Treb+/Treb-** buttons on the remote.

Adjusting Volume

You can use **VOL+** or **VOL-** button to adjust volume. Press **VOL+** button, the volume increase; Press **VOL-** button, the volume decrease.

Muting the Sound

If you want to mute the sound, press **⊗** button on the remote. To resume the sound, press this button again or you can also press **VOL+** or **VOL-** to resume the sound.

Setting Sound mode

This enables the selections of sound mode when receiving IGR system stereo and bilingual broadcasts.

Press **C.SYS** button on the remote and **CH ▲/▼** to select Sound mode item, then adjust with **VOL+/-**.

When **AUTO** is selected, the unit outputs stereo or mono sound according the input signal. When **MONO** is selected, the unit outputs sound monaurally.

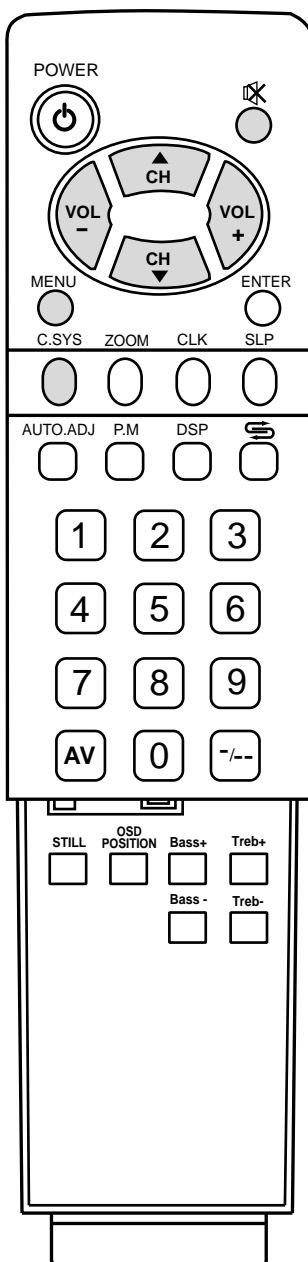
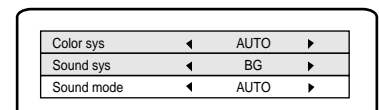

System setting

SETUP		
Color sys	◀	AUTO ▶
Sound sys	◀	BG ▶
Language	◀	Eng ▶
OSD position	◀	Upper Left ▶
Scaler mode	◀	Anamorphic ▶
OSD background	◀	Opaque ▶

<V-> or V+> key to change

To enter into SETUP menu

1. Press **MENU** button repeatedly to display **SETUP** menu.
2. Press **CH ▲/▼** button to select item.
3. Press **VOL+** or **VOL-** button to adjust the selected item.

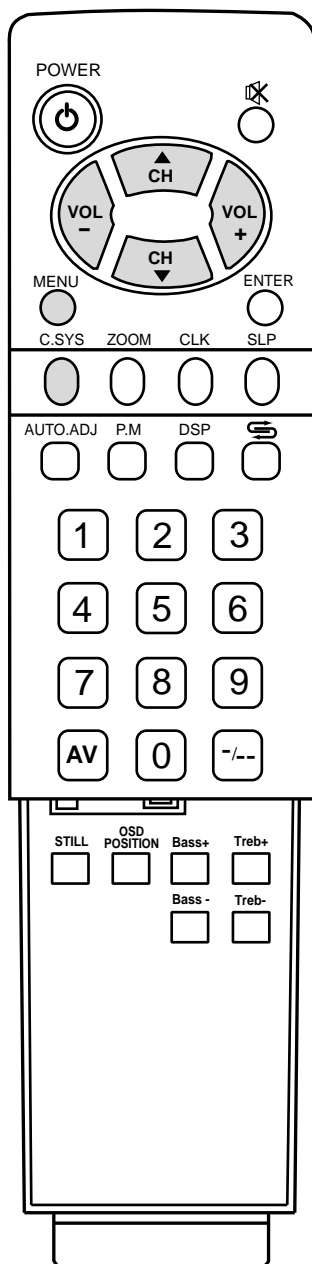

Colour system

From the **SETUP** menu, press **CH ▲/▼** to select **Colour sys** item. Press **VOL-** or **VOL+** button to select a proper colour system according to your area or you can select **AUTO**.

Sound system

From the **SETUP** menu, press **CH ▲/▼** to select **Sound sys** item. Press **VOL-** or **VOL+** button to select a correct sound system.

! Notes:

- You can quickly access colour and sound system by using C.SYS button on the remote.
- In some model, the Colour system and Sound system have been preset and cannot be adjusted.

Setting OSD Language

From the **SETUP** menu, press **CH ▲/▼** to select **Language** item. Press **VOL-** or **VOL+** button to select OSD language.

SETUP		
Color sys	◀	AUTO ▶
Sound sys	◀	BG ▶
Language	◀	Eng ▶
OSD position	◀	Upper Left ▶
Scaler mode	◀	Anamorphic ▶
OSD background	◀	Opaque ▶

<V-> or V+> key to change

SETUP		
Color sys	◀	AUTO ▶
Sound sys	◀	BG ▶
Language	◀	Eng ▶
OSD position	◀	Upper Left ▶
Scaler mode	◀	Anamorphic ▶
OSD background	◀	Opaque ▶

<V-> or V+> key to change

Setting OSD position

From the **SETUP** menu, press **CH ▲/▼** to select **OSD position** item. Press **VOL-** or **VOL+** button to select an **OSD position** in your preference.

! Notes:

You can quickly select OSD position by using **OSD position** button on the remote.

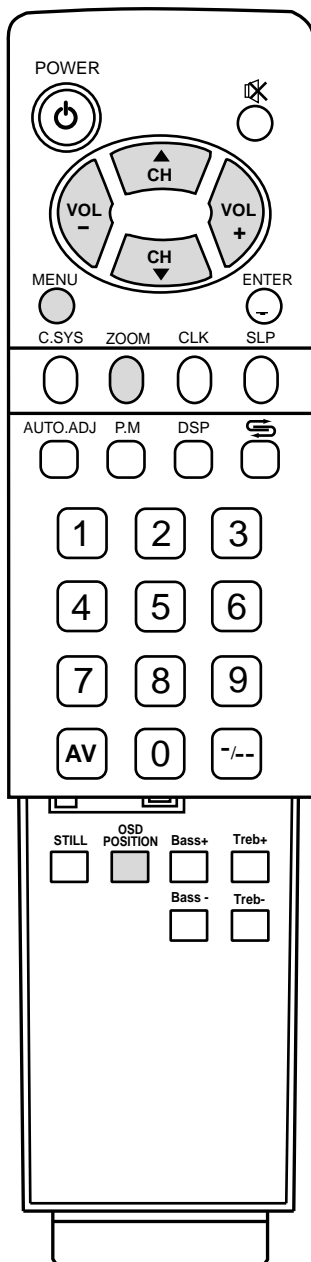

Setting Scaler mode

This unit allows you to adjust screen aspect ratio in your preference. From the **SETUP** menu, press **CH ▲/▼** to select **Scaler mode** item. Press **VOL-** or **VOL+** button to select a proper screen aspect ratio between Anamorphic, 4:3, Panorama, Cinema and Sub Title.

! Notes:

You can quickly select screen ratio by using **ZOOM** button on the remote.

SETUP		
Color sys	◀	AUTO ▶
Sound sys	◀	BG ▶
Language	◀	Eng ▶
OSD position	◀	Upper Left ▶
Scaler mode	◀	Anamorphic ▶
OSD background	◀	Opaque ▶

<V-> or V+> key to change

Setting OSD Background

From the **SETUP** menu, press **CH ▲/▼** to select **OSD Background** item. Press **VOL-** or **VOL+** button to select **Opaque** or **Translucent**.

SETUP		
Color sys	◀	AUTO ▶
Sound sys	◀	BG ▶
Language	◀	Eng ▶
OSD position	◀	Upper Left ▶
Scaler mode	◀	Anamorphic ▶
OSD background	◀	Opaque ▶

<V-> or V+> key to change

Timer

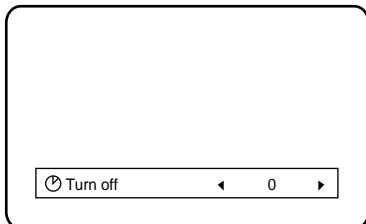

Use SLP button

Press **SLP** button repeatedly to set sleep time between: 0, 10, 20, 30, 60, 90, 120, 180, 240 minutes. If you select 0 minute, it means the sleep timer function is turned off.

Use CLK button

Press **CLK** button, the **Time** menu appears. Use **CH ▲/▼** to select hour or minute (the selected item is displayed in white), use **VOL+/-** to set the time.

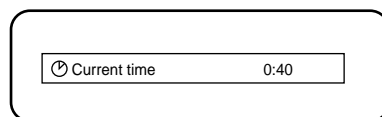

Press **CLK** button twice, the **Turn off** menu appears. Use **VOL+/-** to set the OFF time.

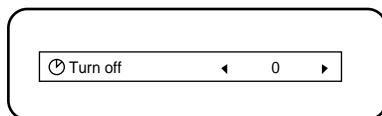

Press **CLK** button three times, the **Turn on** menu appears. Use **CH ▲/▼** to select item and use **VOL+/-** to set ON time and **ON timer** status: Off, On.

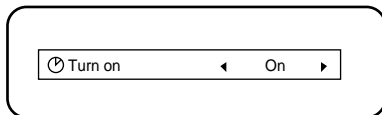

Press **CLK** button four times, the **Turn On Channel** menu appears. Use **VOL+/-** to set ON channel number.

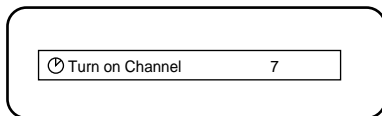

Press **CLK** button five times to close the menu.

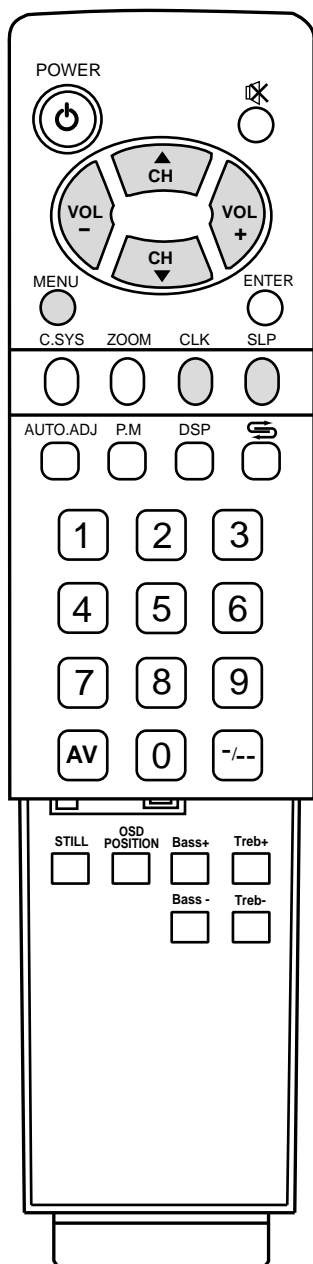

Adjustments in YPbPr mode

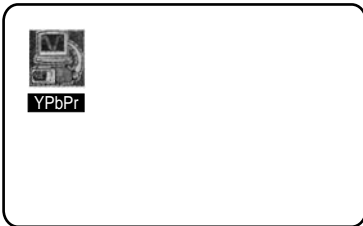

To enter into YPbPr mode

Repeatedly press **AV** button on the remote control or **SOURCE** button on the set's panel until the screen display YPbPr, which indicates that the set is in YPbPr mode. Connect the YPbPr terminals to Set Top Box and make sure there is a signal input.

Adjusting picture

In YPbPr mode when there is correct input signal, press **MENU** button and **PICTURE SETTING** menu appears, Use **CH ▲/▼** to select item and **VOL+/-** to adjust.

Item	VOL-	VOL+
Bright	darker	lighter
Contrast	weaker	stronger
Saturation	paler	deeper
Sharpness	softer	sharper

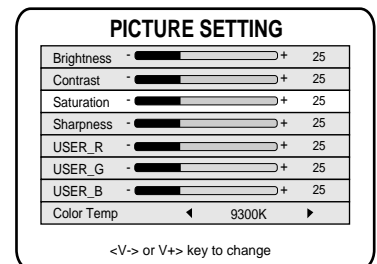

Adjusting Colour temperature

You can select different Colour temperature to obtain correct white. Press **MENU** button, use **CH ▲/▼** to select **Color Temp** item, press the **VOL+/-** to select between **User**, **9300K**, **7300K**, **6500K**.

The **USER_R**, **USER_G** and **USER_B** can not accessed and adjusted unless you set **Color Temp** to "User".

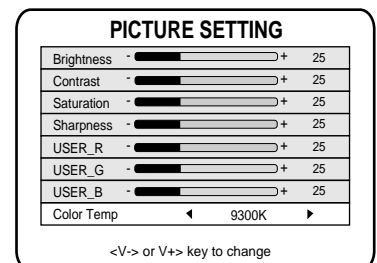

Adjusting horizontal/vertical position

Press **MENU** button twice and the **PICTURE POSITION** menu appears. Use **CH ▲/▼** to select item and **VOL+/-** to adjust.

When a nonstandard signal input to the set and the picture may not be in the screen centre. Now you can adjust its **horizontal** and **vertical** position to display correctly.

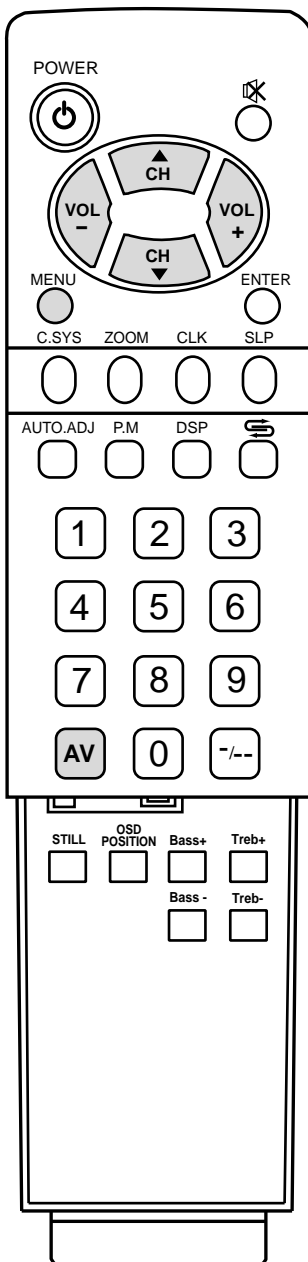
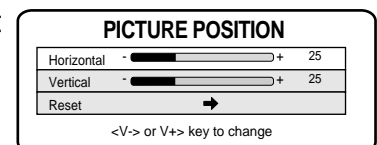

Adjustments in PC mode



To enter into PC mode

Repeatedly press **AV** button on the remote control or **SOURCE** button on the set's panel until the screen display **PC**, which indicates that the set is in **PC** mode.

PC signal format

Please connect VGA input and be sure that there is VGA input signal. The signal format should be one of the follows:

- 640 x 480 @60Hz
- 640 x 480 @75Hz
- 800 x 600 @60Hz
- 800 x 600 @75Hz
- 1024 x 768 @60Hz
- 1024 x 768 @75Hz
- 1280 x 768 @60Hz

We recommend you to use 1024 x 768 @60Hz (4:3) or 1280 x 768 @ 60 Hz (16:9) so that the set can obtain the best picture.

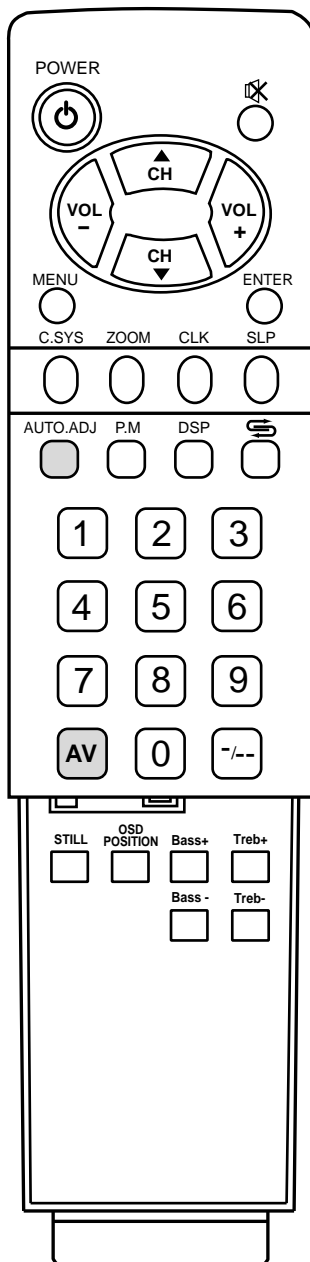

Use AUTO.ADJ button

When PC signal format changes or when you switch to PC mode by **AV** button, the set corrects picture automatically including frequency and phase to obtain the best display. During the process of auto correction, all buttons on the remote control and set's panel do not work until this process is finished.

When the set displays some signal formats that are nonstandard and can not adjust by itself to the best displaying status, now you can press **AUTO.ADJ** button to correct the displaying again.

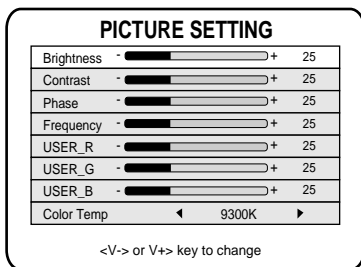

When there is correct input signal, press **MENU** button and **PICTURE SETTING** menu appears. Use **CH ▲/▼** to select item and **VOL+/-** to adjust

Adjusting brightness and contrast

You can adjust bright and contrast in PC mode and this adjustment does not effect the **brightness** and **contrast** in TV and AV mode.

Adjusting phase and frequency

If you can not obtain the best display after auto correction for many times. Now you can adjust **phase** and **frequency** to obtain the best display.

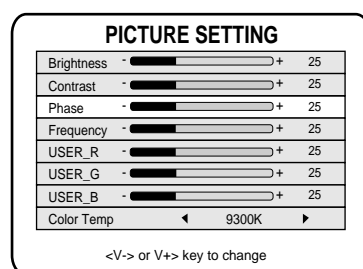

Adjusting Colour temperature

You can select different Colour temperature to obtain correct white. Press **MENU** button, use **CH ▲/▼** to select **Color Temp** item, press the **VOL+/-** to select between **User**, **9300K**, **7300K**, **6500K**.

The **USER_R**, **USER_G** and **USER_B** can not accessed and adjusted unless you set **Color Temp** to "User".

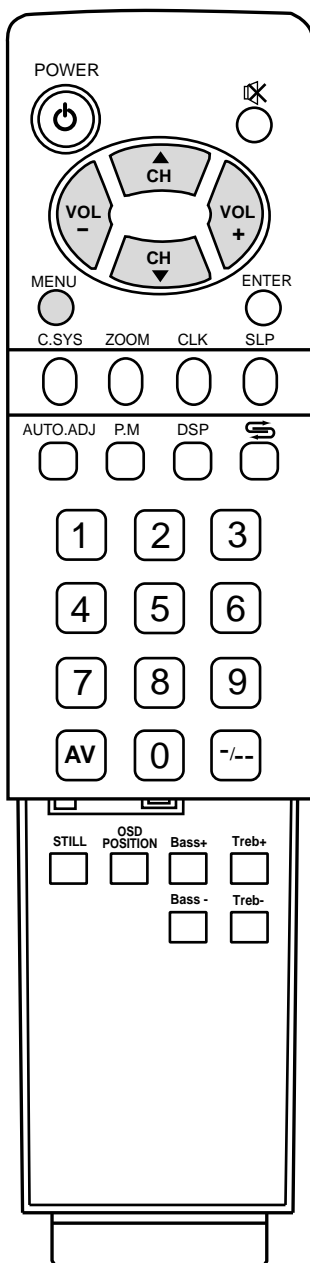
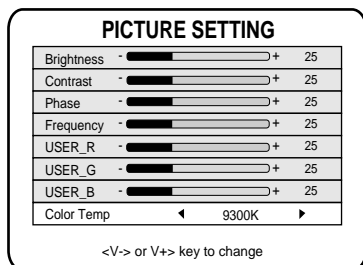

Trouble shooting

Before calling service personnel, please check the following chart for a possible cause to the trouble you are experiencing.

Symptoms	Check the following items
Power is not turned on.	<input type="checkbox"/> Be sure the power cord is plugged in.
Poor colour, poor tint.	<input type="checkbox"/> Contrast, colour, tint are not correctly adjusted.
Spots appear on the screen.	<input type="checkbox"/> Possible interferences of automobiles, motorcycle, trolley bus, neon lamps, etc.
Stripes appear on the screen.	<input type="checkbox"/> Possible interference of electronic interference from another TV set, a computer, an electronics game machine, a broadcast station, etc.
Double images or "ghosts".	<input type="checkbox"/> This may be caused by reflections from nearby mountains or buildings. <input type="checkbox"/> Check the antenna direction.
Snowy picture.	<input type="checkbox"/> It is possible that the aerial "lead-in" is damaged or has come off. <input type="checkbox"/> Check the antenna direction.
TV cabinet creaks.	<input type="checkbox"/> Even if the picture or the sound is normal, changes in the room temperature sometimes make the TV cabinet expand or contract, making a noise. This does not indicate a malfunction.
Remote control does not work.	<input type="checkbox"/> The batteries may be worn out. <input type="checkbox"/> The batteries may be installed with their polarity reversed.

Specifications

Power Supply for AC adaptor:	~240V 50Hz		
Power Consumption:	160W		
Dimensions (mm):	932 (W) x 553 (H) x 245 (D)		
Gross Weight (kg):	17.5		
SCREEN (cm):	76		
TV system & channel range.			
SYSTEM	VHF	UHF	CATV
PAL-B/G	2-12	21-69	X~Z+2, S1~S41
Colour system:	PAL BG, NTSC Playback		
Sound output:	5W x 2		
Accessories	One remote controller; One AC adaptor; One VGA cable, One wall mounting unit.		

 Design and specifications are subject to change without notice.

PALSONIC CORPORATION PTY LTD
1 JOYNTON AVENUE
WATERLOO NSW 2017 AUSTRALIA
TEL: (02) 9313 7111
FAX: (02) 9313 7555
www.palsonic.com.au

**PALSONIC CUSTOMER SERVICE
TELEPHONE
AUSTRALIA: 1300 657 888**

604-L32B13-00

Free Manuals Download Website

<http://myh66.com>

<http://usermanuals.us>

<http://www.somanuals.com>

<http://www.4manuals.cc>

<http://www.manual-lib.com>

<http://www.404manual.com>

<http://www.luxmanual.com>

<http://aubethermostatmanual.com>

Golf course search by state

<http://golfingnear.com>

Email search by domain

<http://emailbydomain.com>

Auto manuals search

<http://auto.somanuals.com>

TV manuals search

<http://tv.somanuals.com>