

OWNER'S MANUAL

Palsonic

**38CM CORDLESS REMOTE LCD TV/MONITOR
MODEL: TFTV-380**



Type Tested
Electrical
Safety

AS/NZS 3250 Lic 3250
Standards Australia
APP No: N17340

PALSONIC CORPORATION PTY LTD
1 JOYNTON AVENUE
WATERLOO NSW 2017 AUSTRALIA
TEL: (02) 9313 7111
FAX: (02) 9313 7555
www.palsonic.com.au

**PALSONIC CUSTOMER SERVICE
TELEPHONE
AUSTRALIA: 1300 657 888**

Contents

Congratulations on your purchase of this **Palsonic LCD TV/MONITOR**.

We recommend that you thoroughly read this manual before use to fully enjoy the many functions and excellent effects of this LCD TV/MONITOR.

Retain this manual in an easily accessible location for future reference.

Note: Screen displays and illustrations in this manual may differ from the actual ones for better visibility.

Contents	1	Channel Select	17
Important Safety Cautions	2	Picture Adjustment	18
Identification of controls	4	System Setting	19
Front	4	Setting Blue Background	19
Back	5	Setting Language	19
Remote control	6	Setting Colour Sys	19
Battery installation	7	Setting Sound Sys	19
Effective remote range	7	Setting sound effect	19
Installation	8	Other Functions	20
Antenna installation	8	Use MUTE button	20
Connecting video/audio equipment	9	Use CLOCK button	20
VGA interface connection	10	Use SLP button	20
Elevation adjustment	11	Adjustment in PC mode	21
Menu introduction	12	To enter into PC mode	21
Turning On/Off	14	PC signal format	21
Turning On	14	Use AUTO CORRECT button ...	22
Turning Off	14	Adjusting bright and contrast	21
Selecting input signal	14	Adjusting horizontal/vertical position	22
Channel Preset	15	Adjusting phase and frequency .	22
To enter into PRESET menu	15	Adjusting Colour temperature ...	22
Auto Search	15	Adjusting Backlight	22
Manual Search	15	Trouble Shooting	23
Fine tuning	15	Specifications	24
Channel Skipping	16		
Channel Edit	16		

Important Safety Cautions

When any unusual situation occurs, turn off the power supply at once and remove the plug from the wall outlet. Contact a qualified service department in your local area.

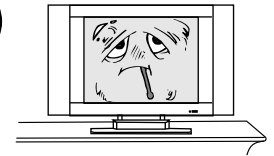

Water and moisture - Do not use this product near water - for example, near a bathtub, washbowl, kitchen sink, or laundry tub, in a wet basement, or near a swimming pool, and the like. Do not use immediately after moving from a low temperature to high temperature environment, as this causes condensation, which may result in fire, electric shock, or other hazards.



Heat sources - Keep the product away from heat sources such as radiators heaters, stoves other heat generating products (including amplifiers).
requirement of environment temperature;
-20°C~50°C for storage; 0°C~40°C for working.

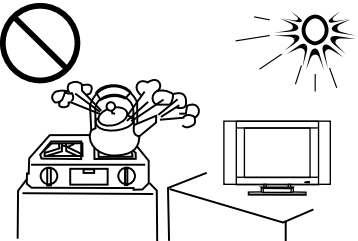

The vents and other openings in the cabinet are designed for ventilation. Do not cover or block these vents and openings since insufficient ventilation can cause overheating and/or shorten the life of the product.

Do not place the product on a bed, sofa, rug or other similar surface, since they can block ventilation openings.

This product is not designed for built-in installation; do not place the product in an enclosed place such as a bookcase or rack, unless proper ventilation is provided or the the manufacturer's instructions are followed.

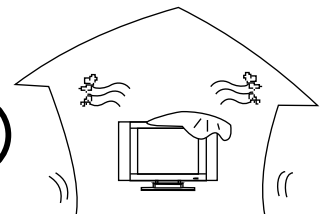

Unplug this product from the wall outlet before cleaning. Do not use liquid cleaners or aerosol cleaners. Use a damp cloth for cleaning.

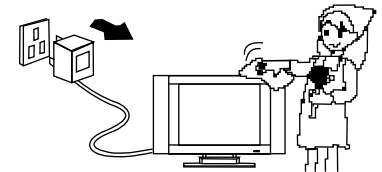

Do not place the product on an unstable trolley, stand, tripod or table. Placing the product on an unstable base can cause the product to fall, resulting in serious personal injuries as well as damage to the product. Use only a trolley, stand, tripod, and bracket or table recommended by the manufacturer or sold with the product.

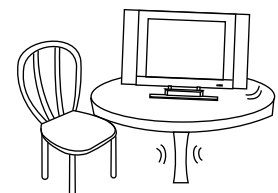

⚠ This TV set can be operated on a power of ~240V 50Hz or 12V DC power. You must not use a power supply of any other type.

When relocating the product placed on a trolley, it must be moved with the utmost care. Sudden stops, excessive force and uneven floor surfaces can cause the product to fall from the trolley.



The power cords must be routed properly to prevent people from stepping on them or objects from resting on them. Check the cords at the plugs and product. Power supply cords should be routed so that they are not likely to be walked on or snagged by items placed upon or against them. Pay particular attention to cords at doors, plugs, receptacles, and the point where they exit from the product. If the power cord or the plug is damaged contact a qualified service department for service.

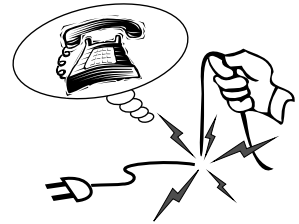

Do not overload wall outlets, extension cords, or convenience receptacles on other equipment as this can result in a risk of fire or electric shock.

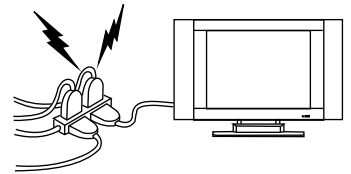

High Voltage exists in this TV set. Do not remove the cover. In case the product needs replacement parts, make sure that the service person uses replacement parts specified by the manufacturer, or those with the same characteristics and performance as the original parts. Use of unauthorised parts can result in fire, electric shock and/or other danger.

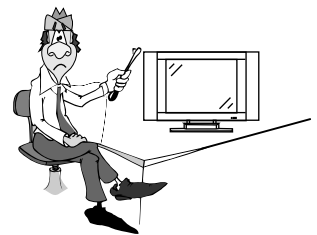

The LCD panel used in this product is made of glass. Therefore, it can break when the product is dropped or impacted upon by other objects. Be careful not to be injured by broken glass pieces in case the LCD panel breaks.

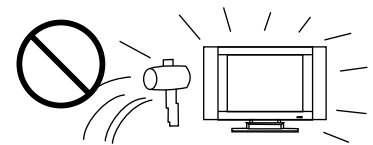

Don't try to push anything into the cabinet or place any vessel with water on the TV set.

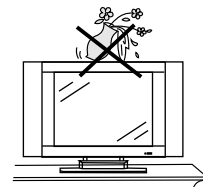

For added protection for this television equipment during a lightning storm, or when it is left unattended and unused for long periods of time, unplug it from the wall outlet and disconnect the antenna. This will prevent damage to the equipment due to lightning and power-line surges.

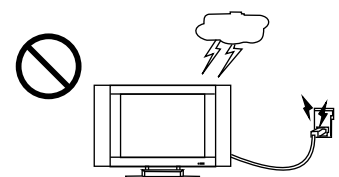

Identification of controls

Front

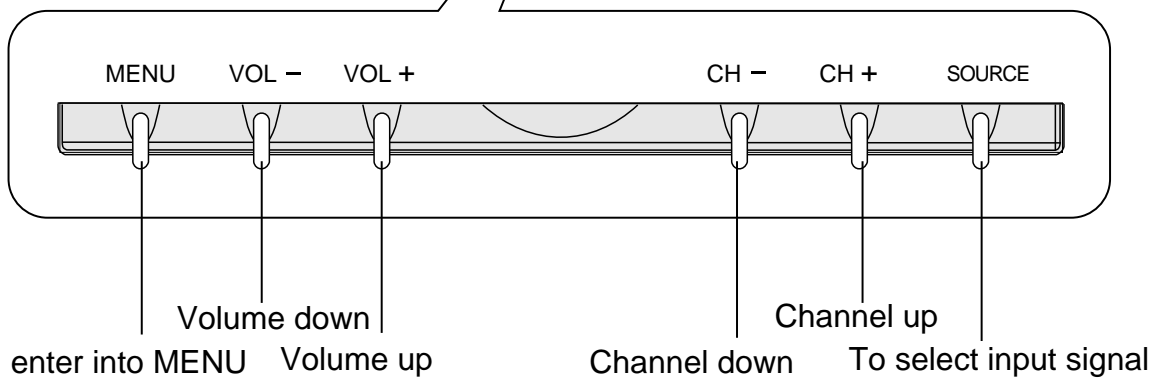

Back

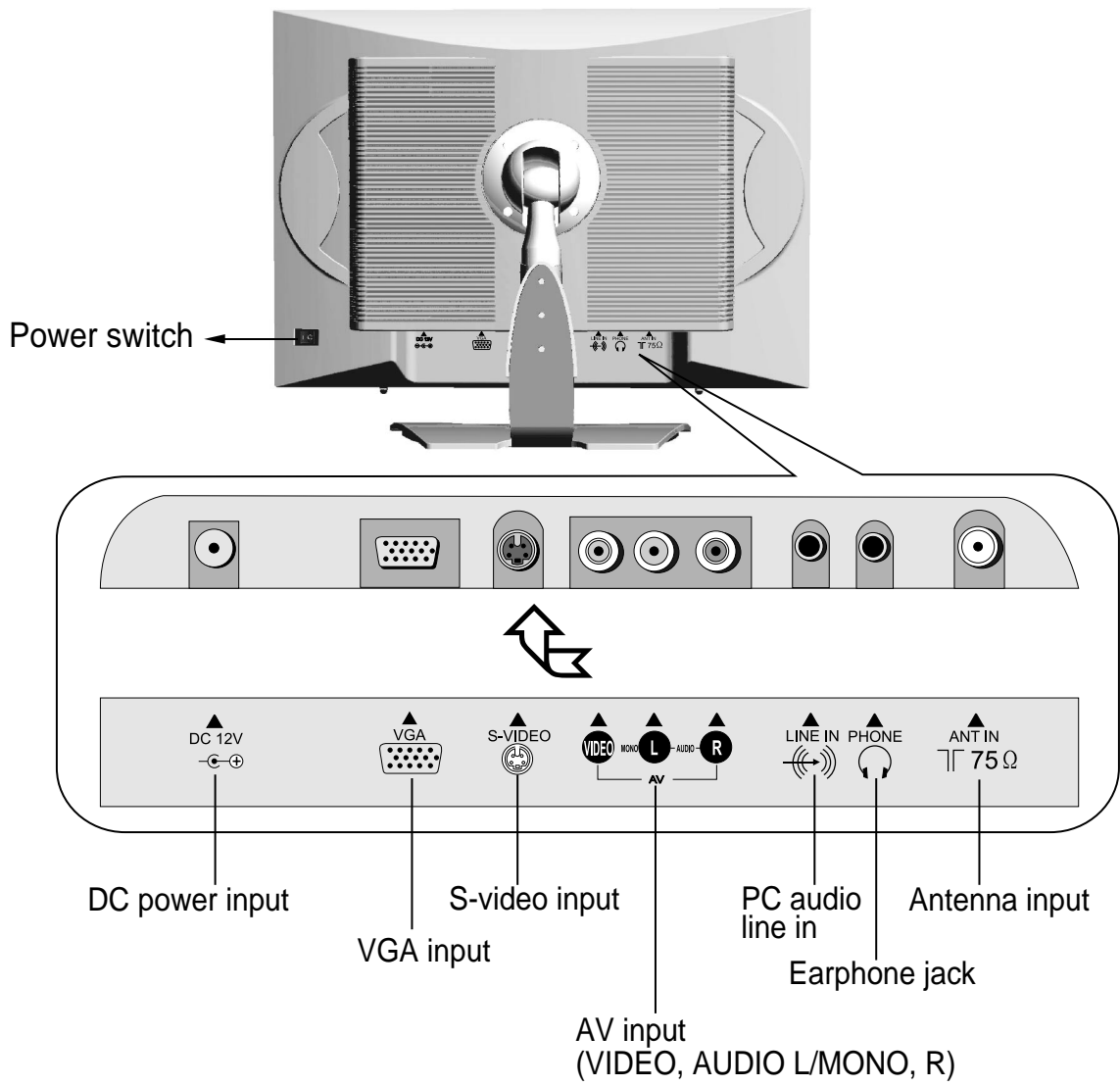

Identification of controls (continued)

Remote Control

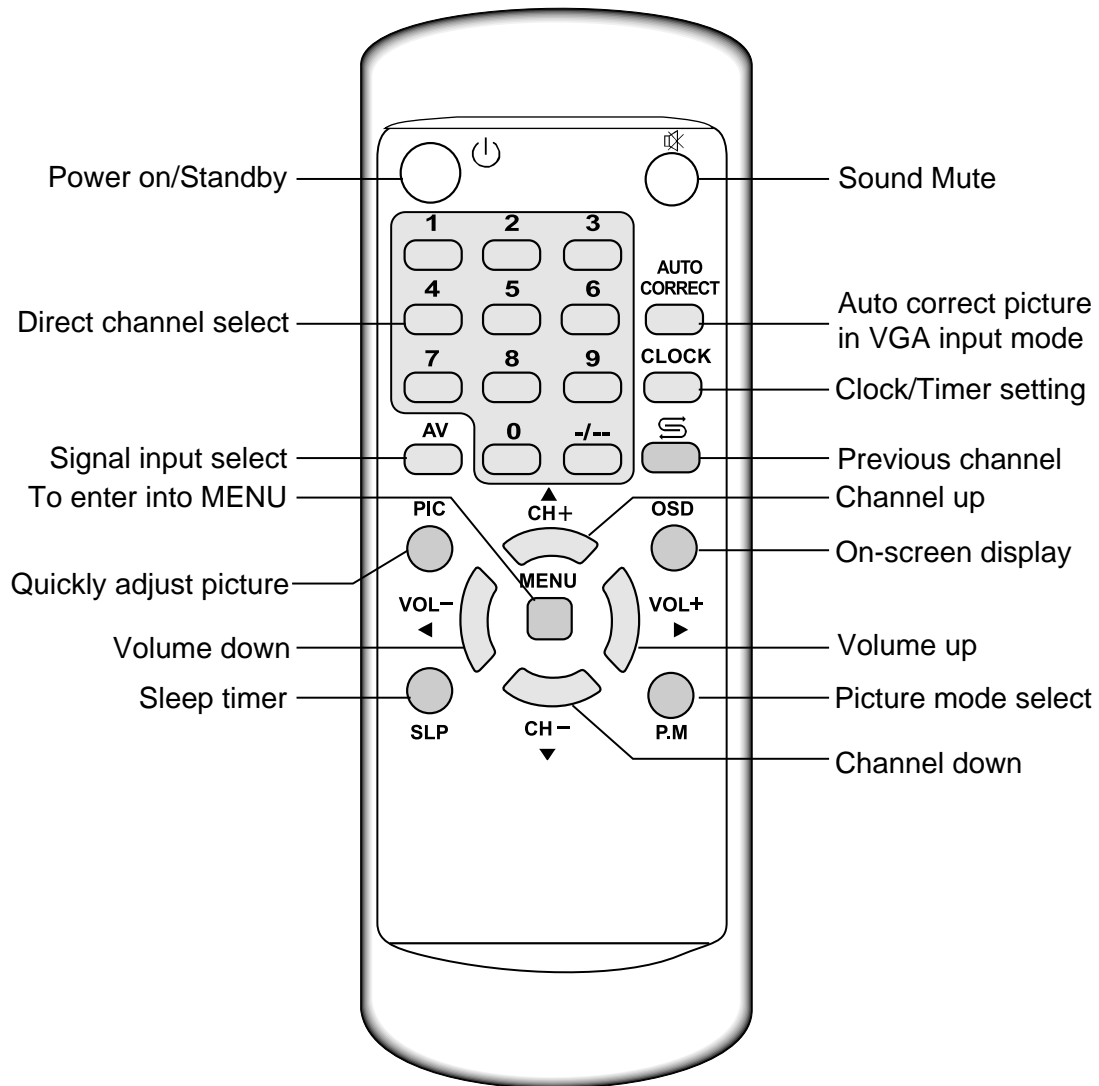

Battery installation

Please install the batteries before using the remote control unit.

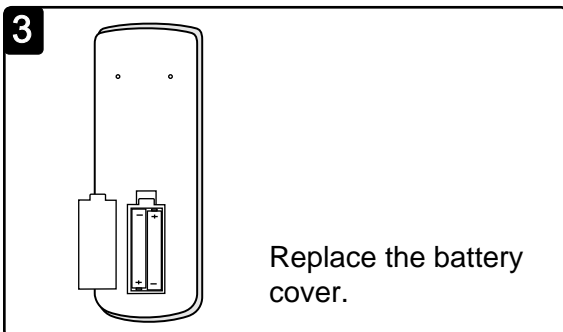
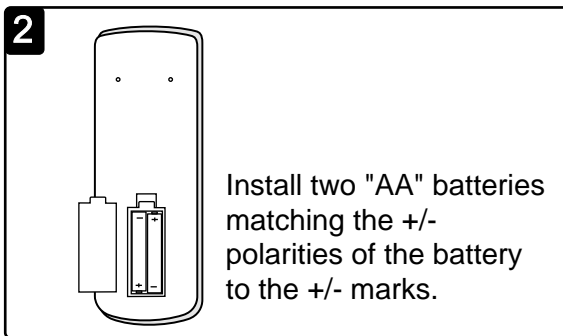
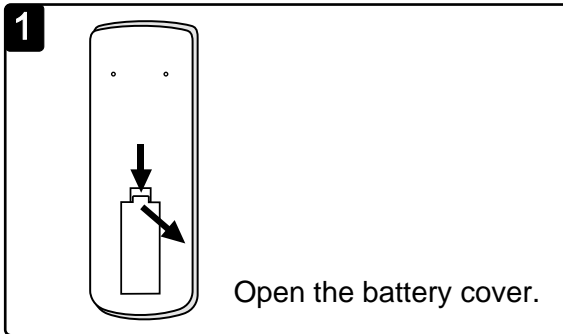

! Notes:

- When the remote control will not be used for a long period of time or when the batteries are worn out, remove the batteries.
- Do not throw the batteries into a fire. Dispose of used batteries in the specified manner.
- Do not drop, dampen or disassemble the remote control.

Effective remote range

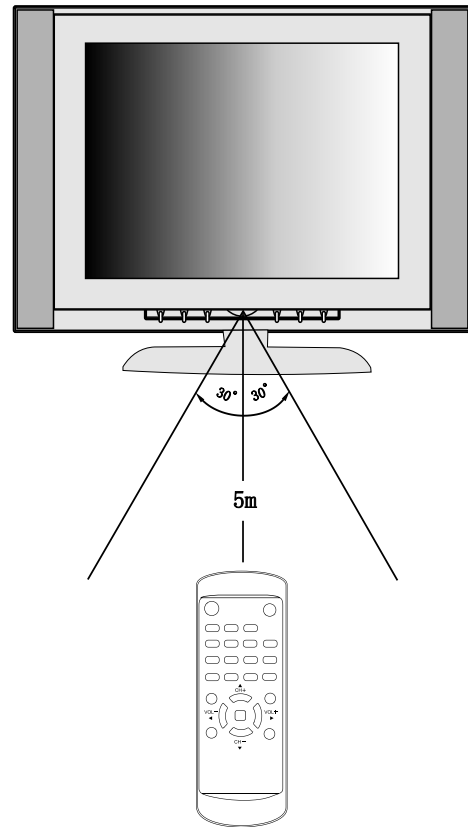

! Notes:

- There should be no obstacle between the TV and the transmitter.
- Use the remote control within the effective range as the above figure.
- If the remote control does not work, please check whether the batteries are exhausted or the polarity is wrong.
- When direct sunlight, and incandescent lamp, fluorescent lamp or any other strong light shines on the REMOTE SENSOR of the TV the remote operation may be unstable.

Installation

Antenna installation

Before using this equipment, please connect the AC power adaptor correctly.

Optimum reception of colour requires a good signal and will generally mean that an outdoor aerial must be used. The exact type and position of the aerial will depend upon your particular area.

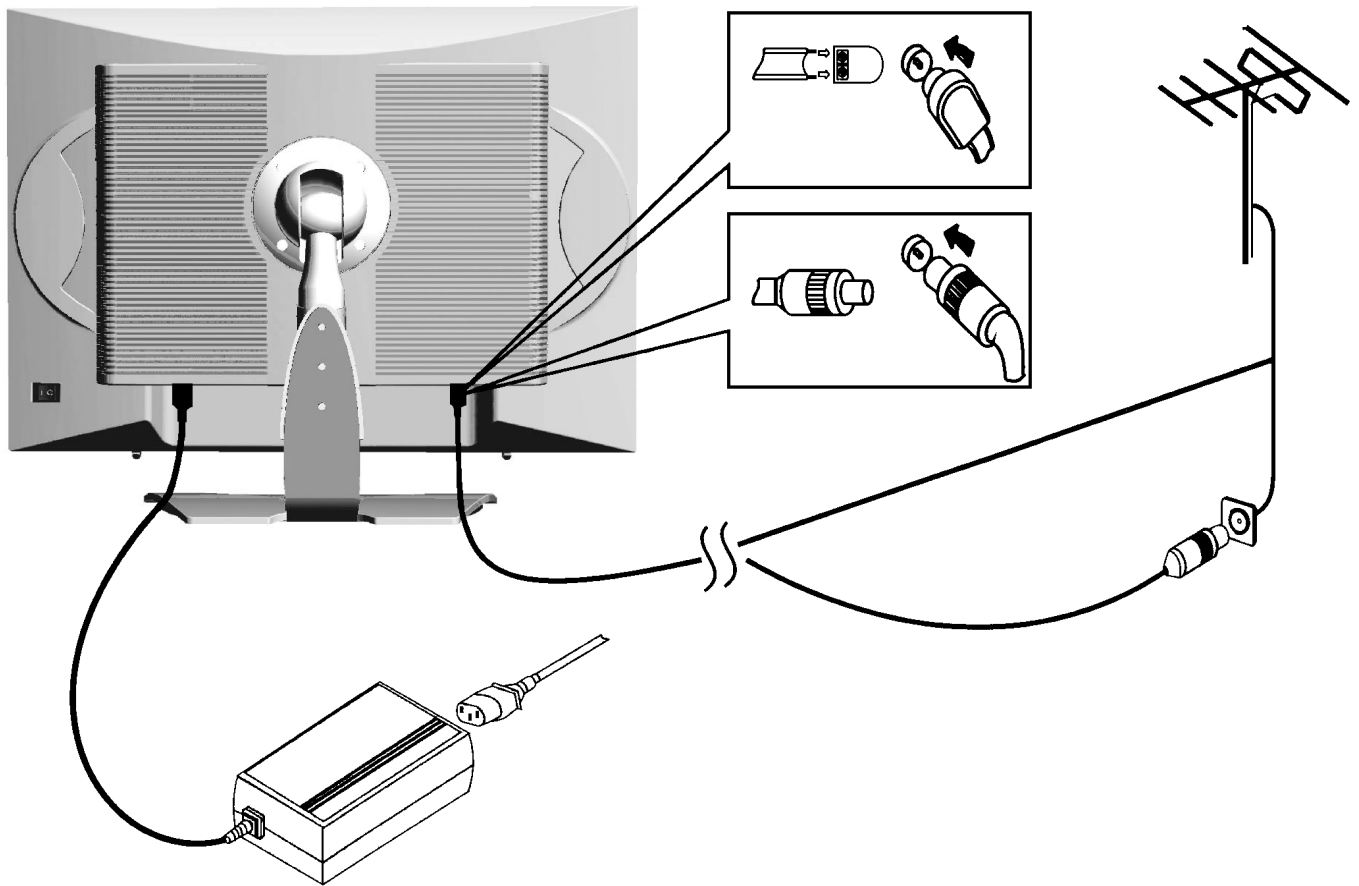

⚠ Notes:

Turn off the power firstly when you connect a outdoor antenna to the Antenna input terminal. When installing an outside antenna system, extreme care should be taken to keep from touching power lines or circuits as contact with them might be fatal.

In thunder and lighting weather, please disconnect the outdoor antenna to avoid thunder/lighting strike.

Connecting video/audio equipment

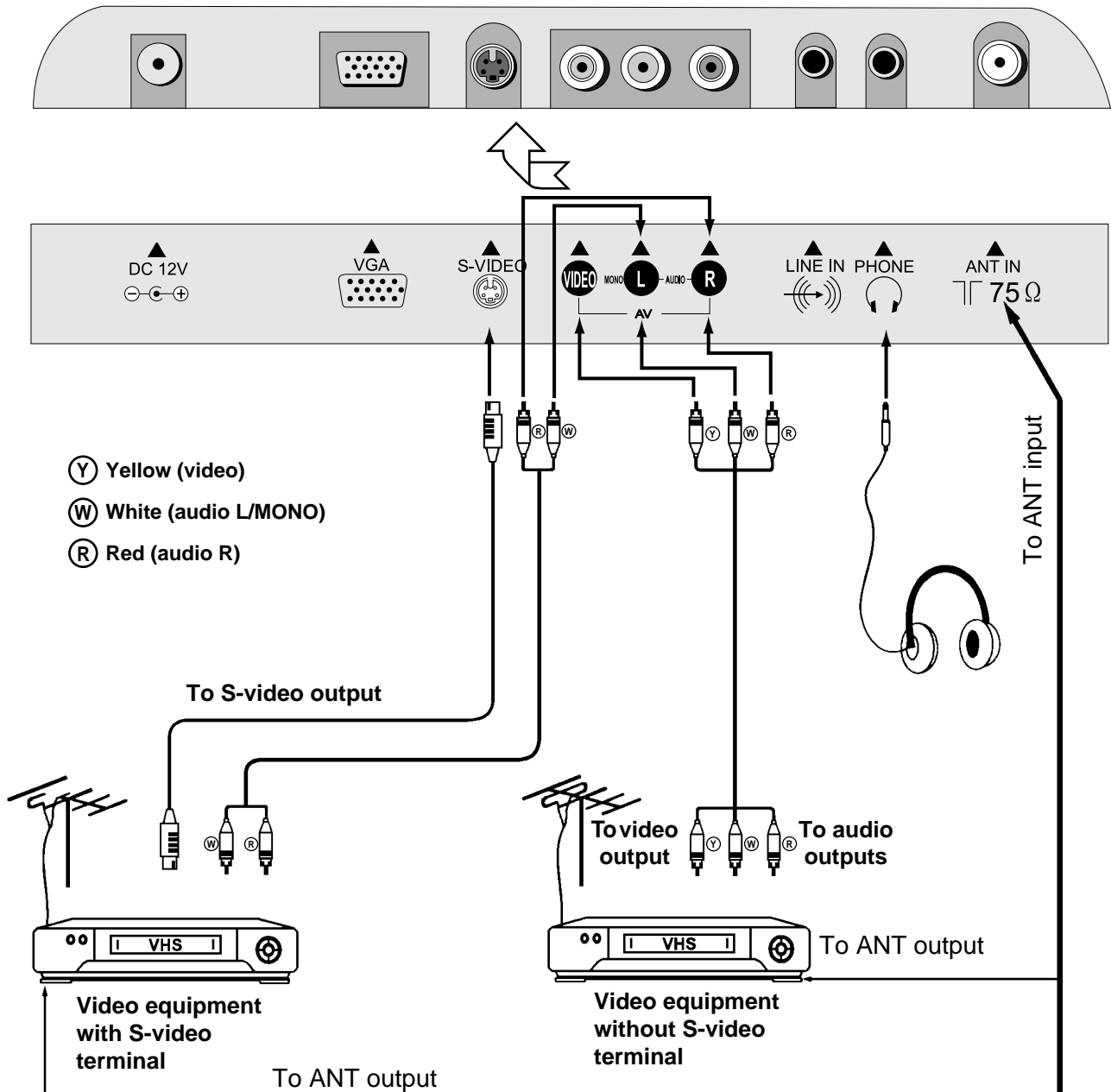

Installation (continued)

VGA interface connection

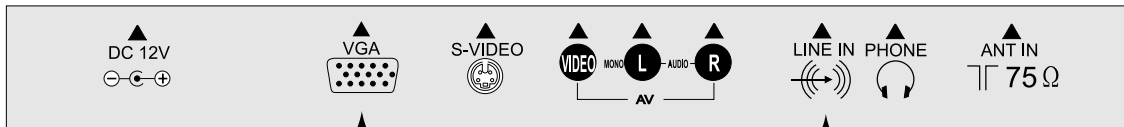
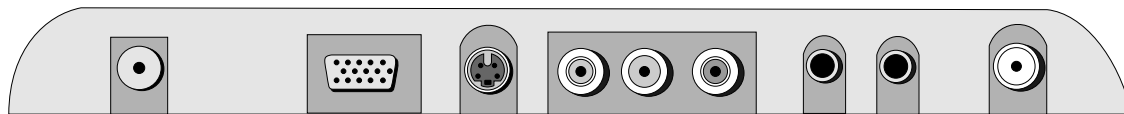

To VGA input

To line in

Equipment with
VGA interface

To line out

To VGA output

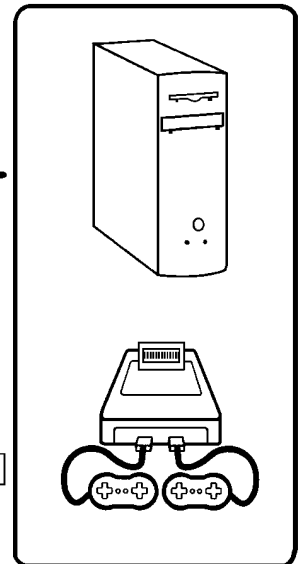

Elevation adjustment

You can adjust the angle of the LCD TV/Monitor as follows.
The elevation can be adjusted from -5° to 90° .

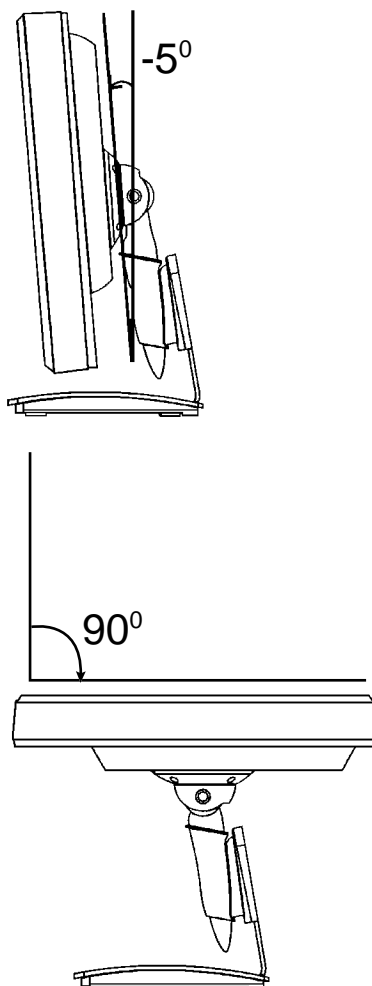

Menu Introduction

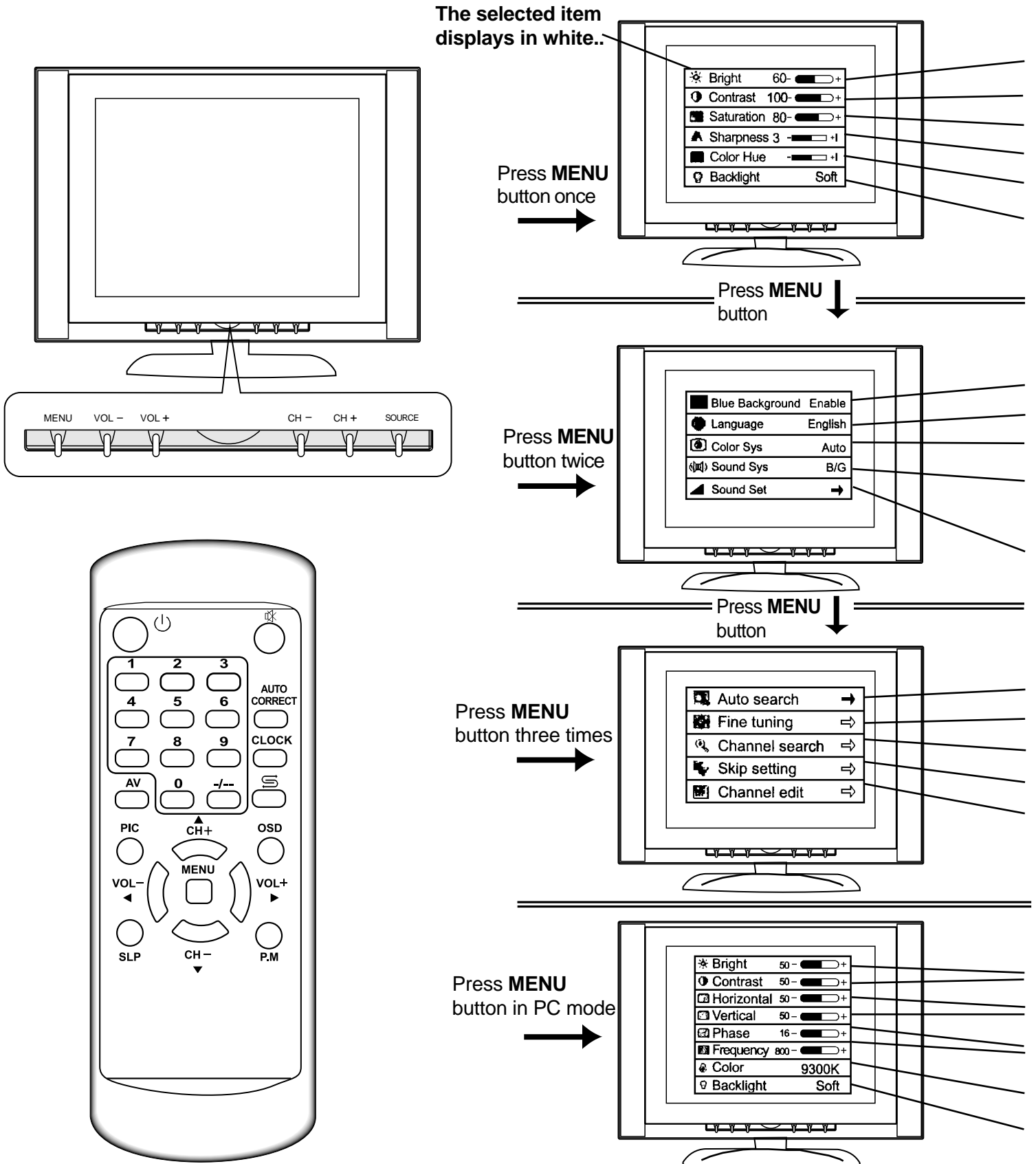

In **MENU** operations, the **CH+/-** buttons are used to select item upwards or downwards; the **VOL+/-** buttons are used to adjust or confirm selected item.

- _____ To adjust the picture's brightness.
- _____ To adjust the picture's contrast.
- _____ To adjust the picture's colour saturation.
- _____ To adjust the picture's sharpness.
- _____ To adjust the picture's skin colour. (This item is available only in NTSC)
- _____ To adjust the back light.

- _____ To set blue background.
- _____ To select OSD language.
- _____ To set the colour system.
- _____ To set the sound system.

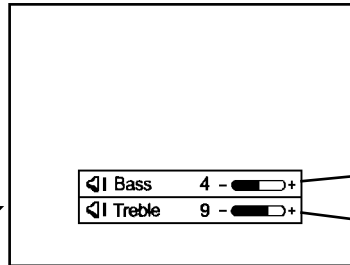

- _____ To adjust the bass
- _____ To adjust the treble

- _____ To enter into auto search.
- _____ To enter into fine tuning menu.
- _____ To enter into channel search menu.
- _____ To enter into skip setting menu.
- _____ To enter into channel edit menu.

- _____ To adjust brightness and contrast in VGA input mode, this adjustment doesn't effect AV or TV mode.
- _____ To adjust horizontal and vertical position in VGA input mode to display picture correctly.
- _____ To adjust phase and frequency if you can't obtain the best picture by using AUTO CORRECT button.
- _____ To adjust the colour temperature.
(The item switches between User, 9300K, 7300K, 6500K, and 5000K)
- _____ To adjust the back light.

Turning On/Off

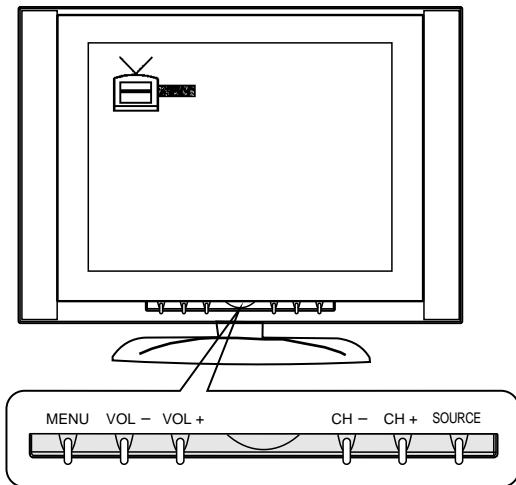

Turning On

1. Insert the outlet plug of the AC power adaptor into the DC power input of the unit.
2. Press the power switch and the red indicator lights up, the TV/MONITOR is in STANDBY mode.
3. Press the **SOURCE** button on the unit's control panel or the button on the remote control, the red indicator turns yellow and the set is turned on.

! Notes:

In TV mode, when there is no TV signal input for about 15 minutes, the set goes to STANDBY automatically. (The **Blue Background** item should be set to Enable).

Turning Off

1. If you want to turn off the power completely, press the power switch.
2. If you want to turn off temporarily, press the button on the remote control, the set goes to STANDBY and the indicator turns red.

! Notes:

This TV set can automatically turn off by:

1. When there is no TV signal input for about 15 minutes;
2. Sleep timer;
3. Off timer.

Selecting input signal

1. Press the **AV** button on the remote control or **SOURCE** button on the control panel to select input mode. You can select **TV**, **AV**, **S-video** or **PC**.
2. If you want to go to TV mode, press **AV** button repeatedly until TV picture displays. You can also press 0~9 digit buttons, **CH+** or **CH-** button to go to TV mode.
3. Press **OSD** button, the screen displays current mode. Press again to cancel OSD.

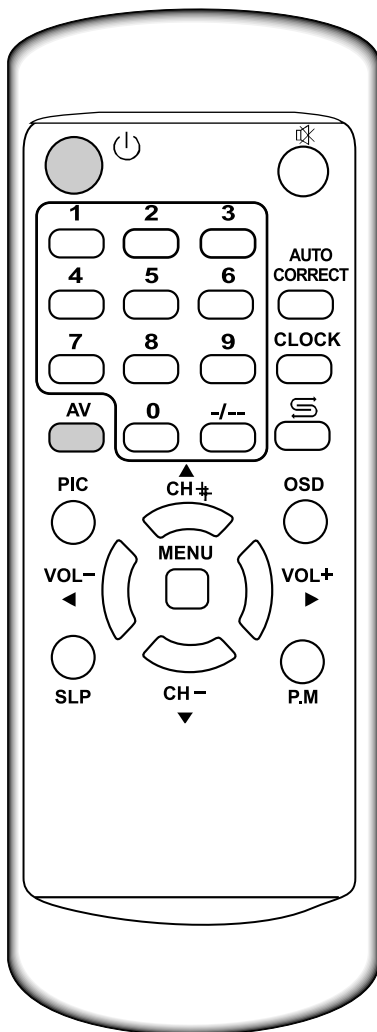

Channel Preset

To enter into PRESET menu

1. Press **MENU** button repeatedly to display **PRESET** menu.
2. Press **CH+/CH-** button to select item.
3. Press **VOL+/VOL-** button to confirm or adjust selected item.

Auto Search

Please enter into **PRESET** menu and select **Auto Search** item. Press **VOL+** button to start Auto Search and all active programs will be memorised.

During the process of Auto Search, press **Menu** button will stop Auto Search.



Channel searching.. VHFL 10

! Notes:

Please confirm the sound system according to your are before Auto Searching.

Manual Search

Use manual search function if desired channels cannot be preset or if you would like to preset channels to specific position numbers one by one.

Use 0~9 digit buttons or **CH+/-** buttons to select a position number firstly, then enter into **PRESET** menu and select **Channel Search** item. Press **VOL+** button to enter Channel Search sub-menu, then press **VOL+** or **VOL-** to start manual search.

Press **MENU** button can exit Channel Search sub-menu.

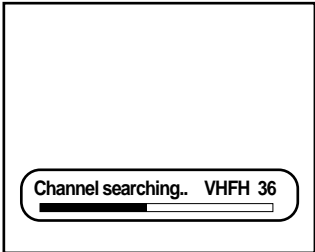

Channel searching.. VHFH 36

Fine tuning

In area of inferior broadcast conditions where adjustment is necessary for a better picture and sound, use Fine tuning.

Use 0~9 digit buttons or **CH+/-** buttons to select a position number firstly, then enter into **PRESET** menu and select **Fine tuning** item. Press **VOL+** button to enter into Fine tuning sub-menu, then press and hold **VOL+** or **VOL-** to start Fine tuning.

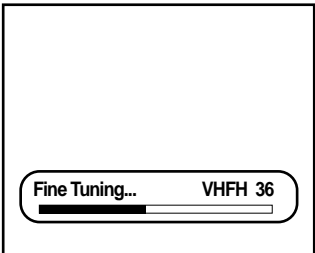

Fine Tuning... VHFH 36

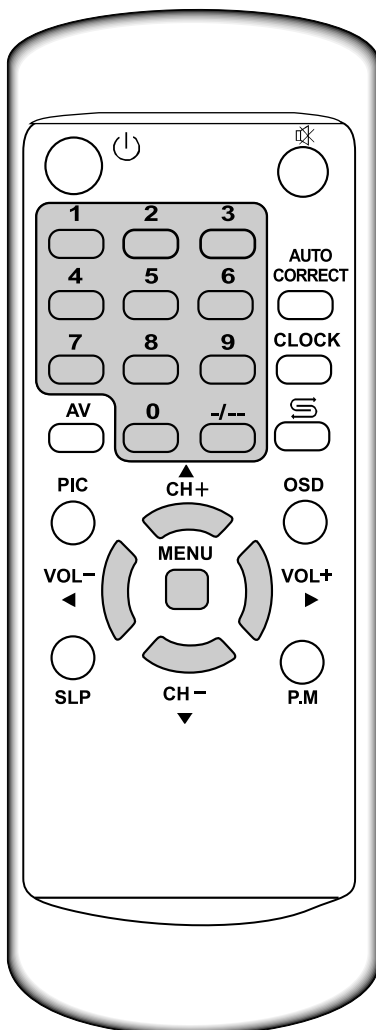
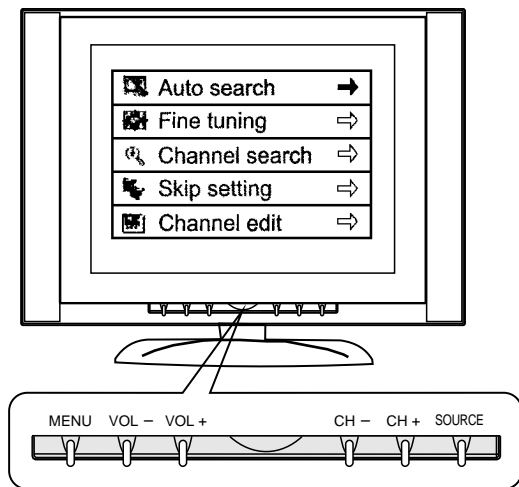

Channel Preset (continued)

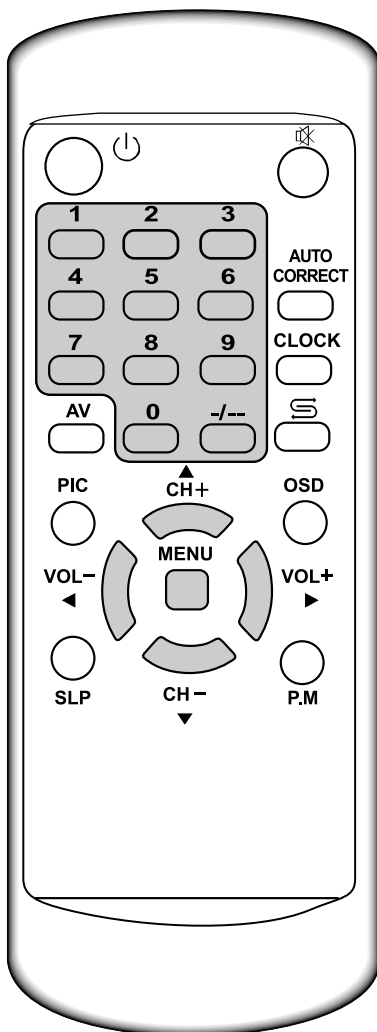
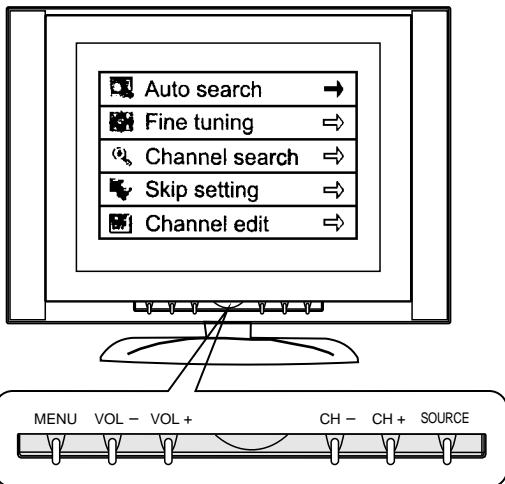

Channel Skipping

You can skip unnecessary channels by using Skip function when you browse program by **CH+/-** buttons.

Use **0~9** digit buttons or **CH+/-** buttons to select a position number firstly, then enter into **PRESET** menu and select **Skip setting** item. Press **VOL+/-** button to skip this channel. Now this channel will be skipped when you browse channels with **CH+/-** button. To resume the skipped channel, please select the skipped channel with **0~9** digit buttons and then enter the **PRESET** menu, select **Skip setting** item and press **VOL+/-** to set this item to **Save**.

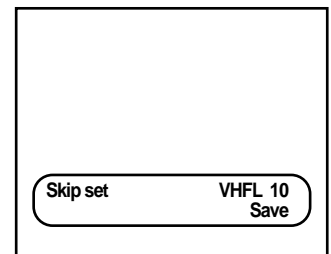
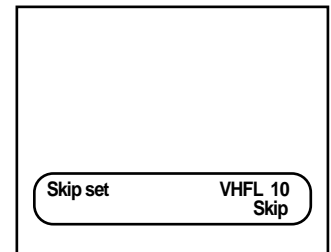

Channel Edit

After Auto Channel Preset, this function is for you to edit the order of programs conveniently according to your favourite.

Please enter into **PRESET** menu and select **Channel Edit** item by **CH+/-** buttons, press **VOL+/-** button to enter into **channel edit** sub-menu. Press **CH+/-** button to select target channel number.

Press **MENU** button to confirm and exit.

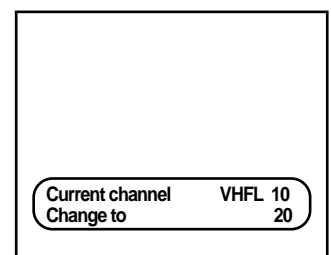

Channel Select

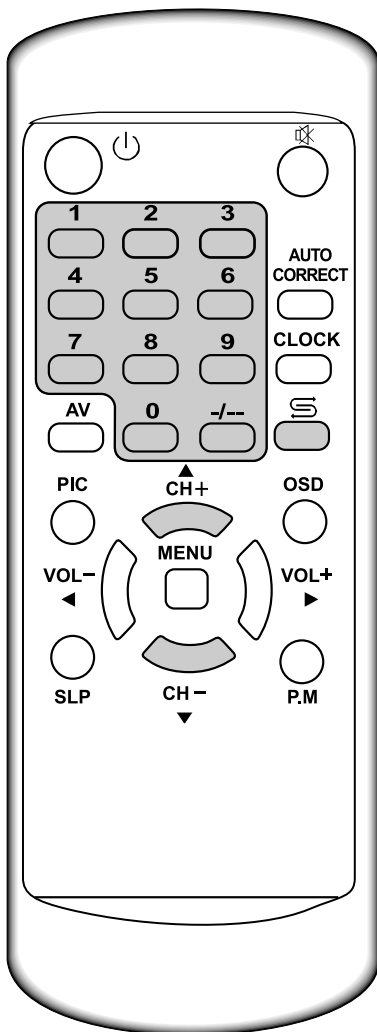
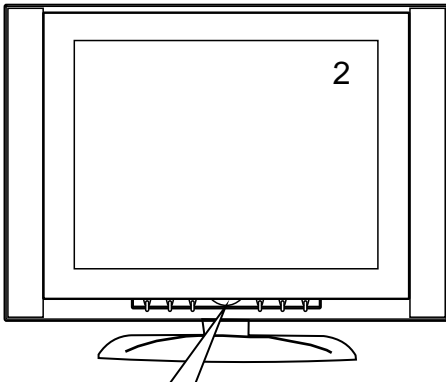

Use 0~9 digit buttons and -/-- button

- ◆ Use 0~9 digit buttons to select one-digit channel number.

Press -/-- button to display "-".

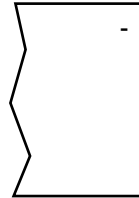

Press 0-9 direct channel selector.

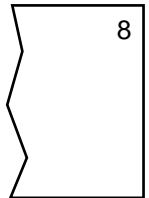

- ◆ To select two-digit channel:

Press -/-- button repeatedly to display "--".

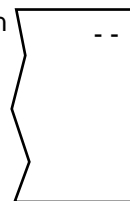

Press 1-9 buttons.



Press 0-9 buttons.

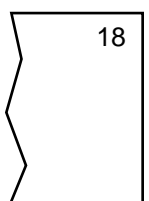

Using CH+/- button

Press **CH+** button, the channel number increases;
Press **CH-** button, the channel number decreases.

Use previous channel button

Press this button to switch between the current channel and previous channel.

Picture Adjustment

Adjusting picture

1. Press **MENU** button to display **Picture** menu.
2. Press **CH+/-** button to **select** item.
3. Press **VOL+/-** button to **adjust** the selected item.

Item	VOL-	VOL+
Bright	darker	lighter
Contrast	weaker	stronger
Saturation	paler	deeper
Sharpness	softer	sharper
Color Hue*	purplish	greenish
Backlight	Nature, Bright, Soft	

* Note: The item **Color Hue** is for NTSC only.

The adjustment settings are stored in the User mode. There are three preset picture mode and one User-set picture mode. Press **P.M** button to select a picture mode according to your favourites.

4. Press **P.M** button to select picture mode.

You can quickly select picture mode by **P.M** button. There are four picture mode as: Bright, Nature, Soft and User mode.

5. You can quickly select Brightness, Contrast, Saturation or Sharpness item by **PIC** button and then adjust them by **VOL+/-** buttons.

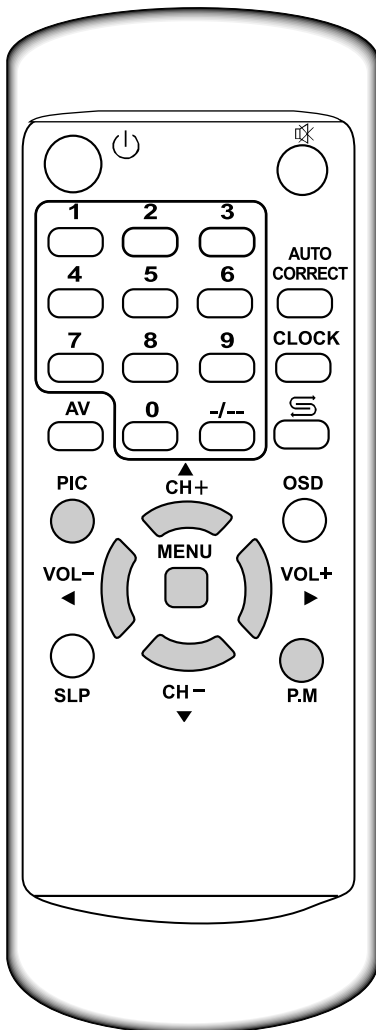
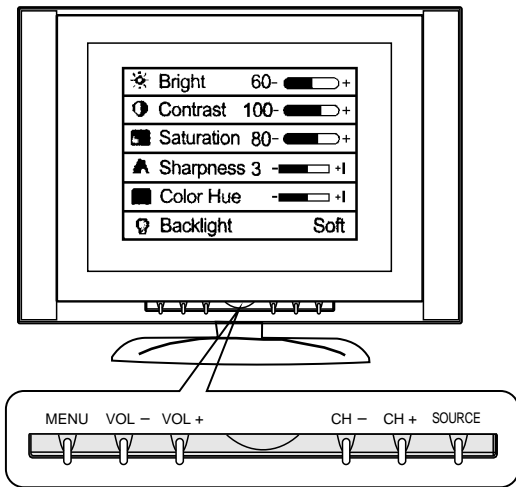

System Setting

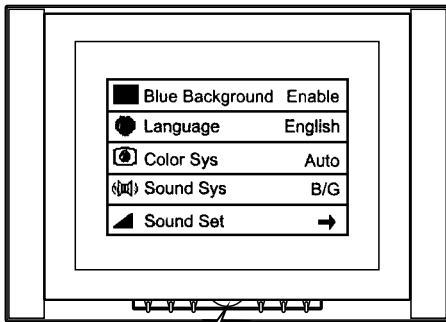

Setting Blue Background

Press MENU button twice to display **SYSTEM** menu and select **Blue Background** item by **CH+/-** button. Press **VOL+** or **VOL-** button to select **Enable** or **Disable**. If is you set the Blue Background item to **Enable**, when there no signal or the signal is too poor, then a blue background will appear.

If you set the Blue Background item to **Disable**, when there is no signal, the screen displays noisy picture.

Notes:

*Only when you set the Blue Background to **Enable**, the TV set can turn off automatically when there is no signal for 15 minutes.*



Setting Language

From the **SYSTEM** menu select **Language** item by **CH+/-** button.

Press **VOL+** or **VOL-** button to select English or Chinese.

Setting Color Sys

From the **SYSTEM** menu select **Color Sys** item by **CH+/-** button. Press **VOL+** or **VOL-** button to select a correct colour system according to your area, or you can select **AUTO**.

Setting Sound Sys

From the **SYSTEM** menu select **Sound Sys** item by **CH+/-** button.

Press **VOL+** or **VOL-** button to select a correct sound system according to your area.

Setting sound effect

From the **SYSTEM** menu select **Sound Set** item by **CH+/-** button.

Press **VOL+** button to enter into sound effect sub-menu. Select **Bass** or **Treble** item by **CH+/-** and adjust by **VOL+/-** buttons.

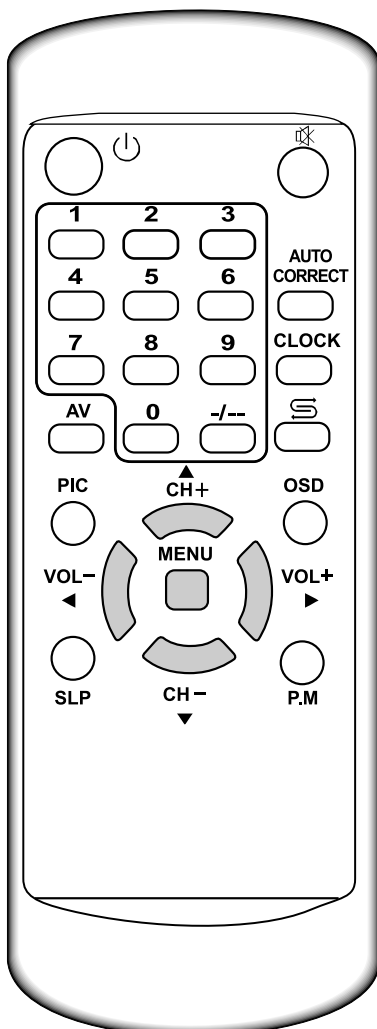
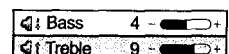

Other Functions

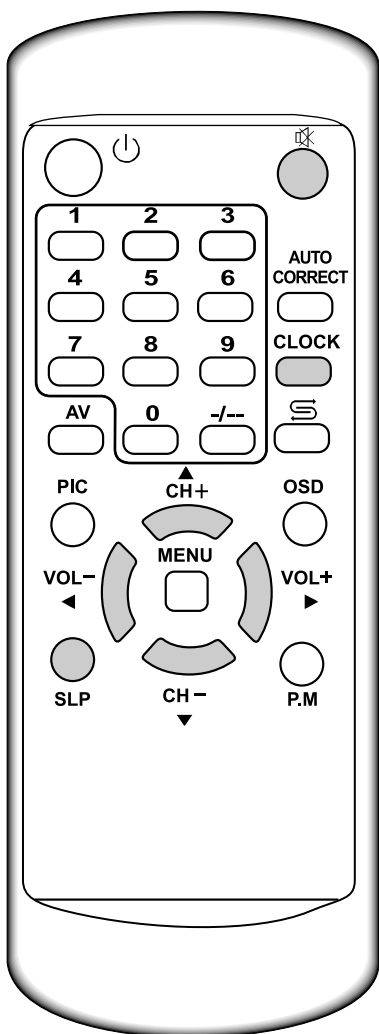
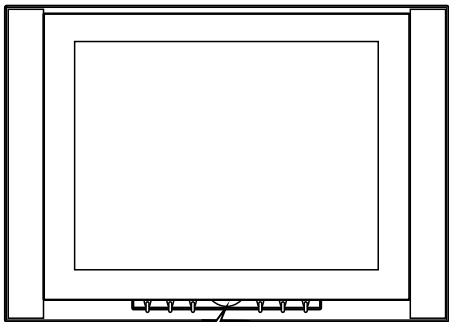

Use MUTE button

Press **MUTE** button to mute the sound. If you want to cancel sound muting, you can press this button again or press **VOL+/-** buttons.



Use CLOCK button

Press the **CLOCK** button, the **CLOCK** menu appears. Use **CH+/-** to select hour or minute (the select item displays in blue), use **VOL+/-** to adjust the time. Press the **CLOCK** button twice, the **Turn on** menu appears. Use **CH+/-** to select item and use **VOL+/-** to adjust on time and on time status: **Off**, **Today** or **Everyday**.

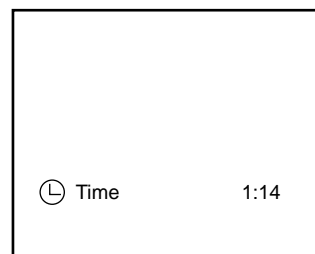

If you select **Today**, the **Turn on** function only effect today.

If you select **Everyday**, the **Turning on** function effects everyday.



Press **CLOCK** button three times, the **Turn off** menu appears, you can operate by referring to the above steps.

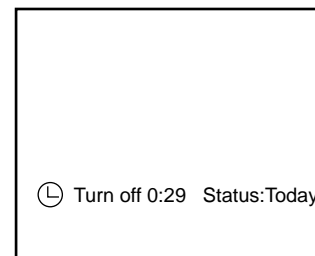

Use SLP button

Press this button repeatedly to set the sleep time between 0, 10, 20, 30, 60, 90, 120, 180 or 240 minutes. If you select 0 minute, that means the sleep timer function is turned off.



Adjustments in PC mode

To enter into PC mode

Repeatedly press **AV** button on the remote control or **SOURCE** button on the control panel until the screen display PC, which indicates that the set is in PC mode.

PC signal format

Please connect VGA input and be sure that there is VGA input signal. The signal format should be one of the follows:

640 x 480 @60Hz

640 x 480 @75Hz

800 x 600 @60Hz

800 x 600 @75Hz

1024 x 768 @60Hz

1024 x 768 @75Hz

We recommend you to use 1024 x 768 @60Hz so that the set can obtain the best picture.

Use AUTO CORRECT button

When PC signal format changes or when you switch to PC mode by **AV** button, the set corrects picture automatically including frequency and phase to obtain the best display. During the process of auto correction, all buttons on the remote control and control panel do not work until this process is finished.

When the set displays some signal formats that are nonstandard and can not adjust by itself to the best displaying status, now you can press **AUTO CORRECT** button to correct the displaying again.

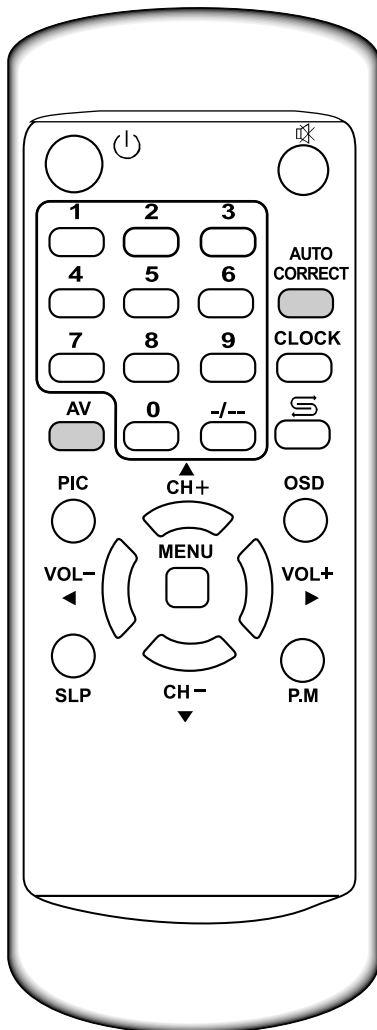
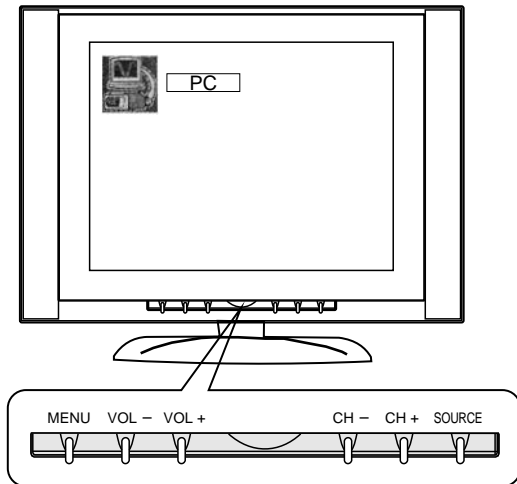

Adjustments in PC mode (continued)

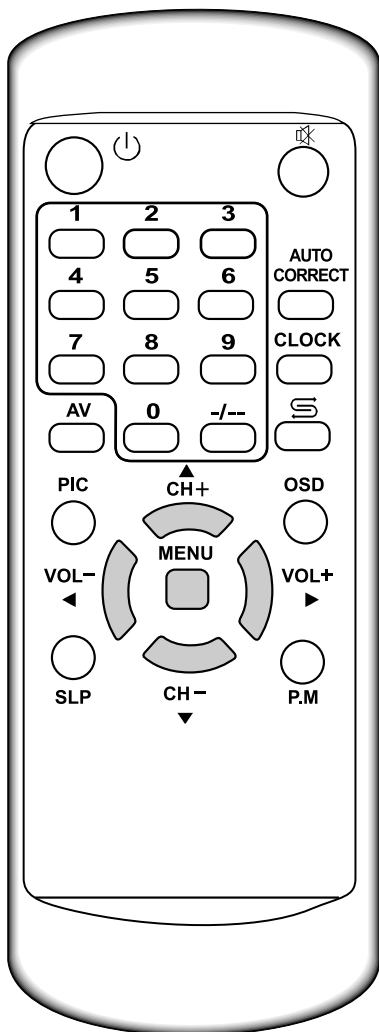
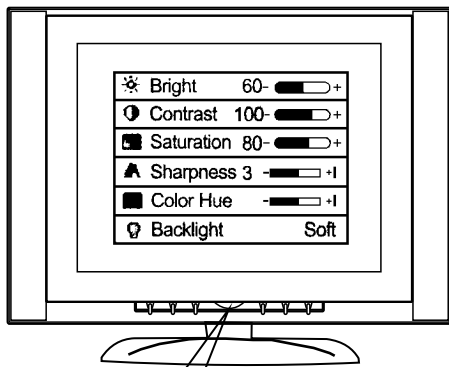

When there is correct input signal, press **MENU** button and **PC** menu appears. Use **CH+/-** to select item and **VOL+/-** to adjust

Adjusting bright and contrast

You can adjust bright and contrast in PC mode and this adjustment does not effect the **bright** and **contrast** in TV and AV mode.

Adjusting horizontal/vertical position

When a nonstandard signal input to the set and the picture may not be in the screen centre. Now you can adjust its **horizontal** and **vertical** position to display correctly.

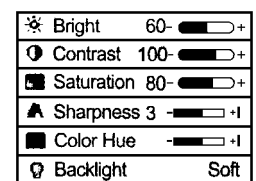

Adjusting phase and frequency

If you can not obtain the best display after auto correction for many times. Now you can adjust **phase** and **frequency** to obtain the best display.

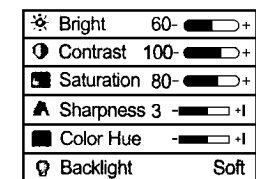

Adjusting Colour temperature

You can select different Colour temperature to obtain correct white. Press **MENU** button, use **CH+/-** to select **Color** item, press the **VOL+/-** to select between **User**, **9300K**, **7300K**, **6500K** or **5000K**.

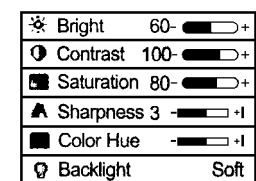

Adjusting Backlight

You can adjust the **Backlight** according to your favourites. Press **MENU** button, use **CH+/-** to select **Backlight** item, press **VOL+/-** to select between **Soft**, **Bright** or **Nature**.

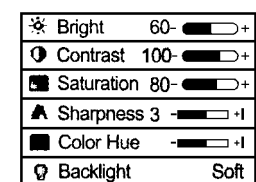

Trouble shooting

Before calling service personnel, please check the following chart for a possible cause to the trouble you are experiencing.

Symptoms	Check the following items
Power is not turned on.	<input type="checkbox"/> Be sure the power cord is plugged in.
Poor colour, poor tint.	<input type="checkbox"/> Contrast, colour, tint are not correctly adjusted.
Spots appear on the screen.	<input type="checkbox"/> Possible interferences of automobiles, motorcycle, trolley bus, neon lamps, etc.
Stripes appear on the screen.	<input type="checkbox"/> Possible interference of electronic interference from another TV set, a computer, an electronics game machine, a broadcast station, etc.
Double images or "ghosts".	<input type="checkbox"/> This may be caused by reflections from nearby mountains or buildings. <input type="checkbox"/> Check the antenna direction.
Snowy picture.	<input type="checkbox"/> It is possible that the aerial "lead-in" is damaged or has come off. <input type="checkbox"/> Check the antenna direction.
TV cabinet creaks.	<input type="checkbox"/> Even if the picture or the sound is normal, changes in the room temperature sometimes make the TV cabinet expand or contract, making a noise. This does not indicate a malfunction.
Remote control does not work.	<input type="checkbox"/> The batteries may be worn out. <input type="checkbox"/> The batteries may be installed with their polarity reversed.

Specifications

Power Supply for AC adaptor: ~240V 50Hz

Power Supply of this TV set: DC 12V

Power Consumption: AC 35W

Dimensions (mm): 585 (W) x 515 (H) x 257 (D)

Gross Weight (kg): 7.5

SCREEN (cm): 38

TV system & channel range.

SYSTEM	VHF	UHF	CATV
PAL-D/K	1-12	13-57	Z1~Z37
PAL-B/G	2-12	21-69	X~Z+2, S1~S41
PAL-I	2-12	21-69	
NTSC-M US	2-13	14-79	A-6~A-1, A~W, AA~FFF
SECAM-B/G	2-12	21-69	X~Z+2, S1~S41
SECAM-D/K	1-12	21-69	

Colour system: PAL/NTSC/SECAM, NTSC-4.43, PAL-60

Sound output: 1W x 2

Accessories One remote controller;
One AC adaptor;
One VGA cable.

 Design and specifications are subject to change without notice.

PALSONIC CORPORATION PTY LTD
1 JOYNTON AVENUE
WATERLOO NSW 2017 AUSTRALIA
TEL: (02) 9313 7111
FAX: (02) 9313 7555
www.palsonic.com.au

**PALSONIC CUSTOMER SERVICE
TELEPHONE
AUSTRALIA: 1300 657 888**

604-L1513-01

Free Manuals Download Website

<http://myh66.com>

<http://usermanuals.us>

<http://www.somanuals.com>

<http://www.4manuals.cc>

<http://www.manual-lib.com>

<http://www.404manual.com>

<http://www.luxmanual.com>

<http://aubethermostatmanual.com>

Golf course search by state

<http://golfingnear.com>

Email search by domain

<http://emailbydomain.com>

Auto manuals search

<http://auto.somanuals.com>

TV manuals search

<http://tv.somanuals.com>