

**OWNER'S MANUAL**

# **Palsonic**

**68CM CORDLESS REMOTE COLOUR TELEVISION  
MODEL: 6875PF**



**N111**

**PALSONIC CORPORATION PTY LTD  
1 JOYNTON AVENUE  
WATERLOO NSW 2017 AUSTRALIA  
TEL: (02) 9313 7111  
FAX: (02) 9313 7555  
[www.palsonic.com.au](http://www.palsonic.com.au)**

**PALSONIC CUSTOMER SERVICE  
TELEPHONE  
AUSTRALIA: 1300 657 888**

**Congratulations on your purchase of this  
Palsonic colour television receiver.**

**We recommend that you thoroughly read this  
manual before use to fully enjoy the many  
functions and excellent effects of this receiver.**

**Retain this manual in an easily accessible  
location for future reference.**

**Screen displays and illustrations in this  
manual may differ from the actual ones  
for better visibility.**

# Contents

<b>Features</b> .....	1
<b>Important Safety Cautions</b> .....	2
<b>Identification of Controls</b> .....	4
Front view .....	4
Back view .....	5
Remote control .....	6
Battery installation .....	7
Effective range of the remote .....	7
<b>Installation</b> .....	8
Connecting antenna .....	8
Connect to video and audio equipment .....	9
<b>Operations</b> .....	11
Menu introduction .....	11
Turning on .....	12
Turning off .....	12
Presetting programs .....	13
Auto search .....	13
Manual search .....	13
Fine Tuning .....	14
Editing programs .....	15
Channel skipping .....	15
Classifying Programs .....	15
Channel exchange/copy .....	16
Setting Colour/Sound system .....	16
Selecting channel/input signal .....	17
Selecting channel .....	17
Selecting external input signal .....	17
Adjusting the picture/sound .....	18
Clock setting .....	19
Current time setting .....	19
Off timer setting .....	19
On timer setting .....	19
Setting channel timer .....	20
System setting .....	21
Background .....	21
Colour/sound system .....	21
Other function introduction .....	22
<b>Troubleshooting Guide</b> .....	25
<b>Specifications</b> .....	26

- ▶ **USOC and Intellectualized I<sup>2</sup>C-bus control**
- ▶ **Five picture modes**
- ▶ **Two groups of Video/Audio input terminals**
- ▶ **One S-Video terminal**
- ▶ **One group of DVD (Y,Cr,Cb) input terminals**
- ▶ **Video/Audio output terminal**
- ▶ **Program exchange/Program copy**
- ▶ **Game/Calendar**
- ▶ **Child lock function**
- ▶ **200 channels**
- ▶ **Music TV function**
- ▶ **Noise reduction**
- ▶ **Image enhancing**
- ▶ **Programs classified**
- ▶ **Screen protecting function**

# Important Safety Cautions

- ◆ *When any unusual situation occurs, turn off the power supply at once and remove the plug from the wall outlet. Contact a qualified service department in your local area.*

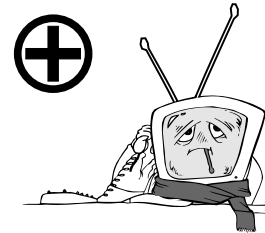

- ◆ *Do not expose the TV set to rain or excessive moisture. Avoid using the set in very warm or damp places and never use it in a bathroom.*



- ◆ *When cleaning dust off the picture tube disconnect the power first. You can wipe lightly with a piece of dry, clean and soft cloth.*

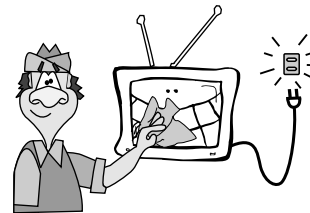

- ◆ *Avoid exposing the set to direct sunlight and other sources of heat to prevent damage to the cabinet and components.*

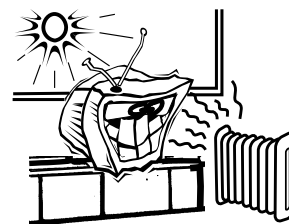

- ◆ *High voltage exists in this TV set. Do not remove the cover.*



⚠ *This TV set can operate on a power of ~240V, 50Hz. You must not use a power supply of any other type.*

- ◆ *Do not cover the ventilating hole in the cabinet. Keep a space of more than 10cm from the walls to the TV set to ensure adequate ventilation.*

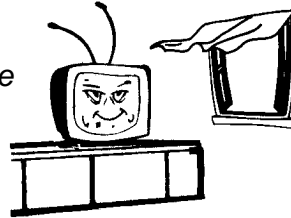

- ◆ *If the power cord or the plug is damaged contact a qualified service department for service.*

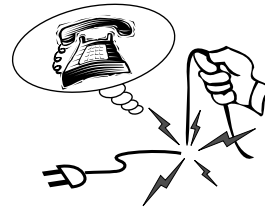

- ◆ *When the TV set is to be left unattended for a long period of time, turn off the power supply and remove the plug from the wall outlet.*

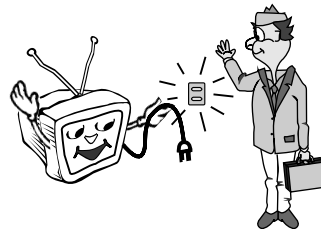

- ◆ *Don't try to push anything into the cabinet or place any vessel with water on the TV set.*

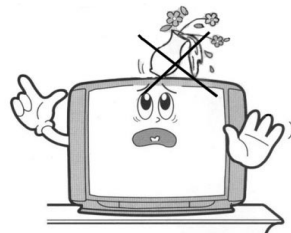

- ◆ *Don't overload wall outlets; extension cords, or integral convenience receptacles as this can result in a risk of fire or electric shock.*

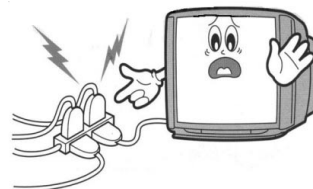

### **Auto degaussing:**

When you remove the TV set to another place or when other electronic machines near the set are working, the colour TV set will be magnetised. The colour of the TV will be abnormal and the colour points appear on the screen. To avoid the bad effect, an auto degaussing circuit is designed. When the TV set is magnetised you should cut off the power to the set for at least 30 minutes to assure the auto degaussing circuit works well.

# Identification of Controls

## Front view

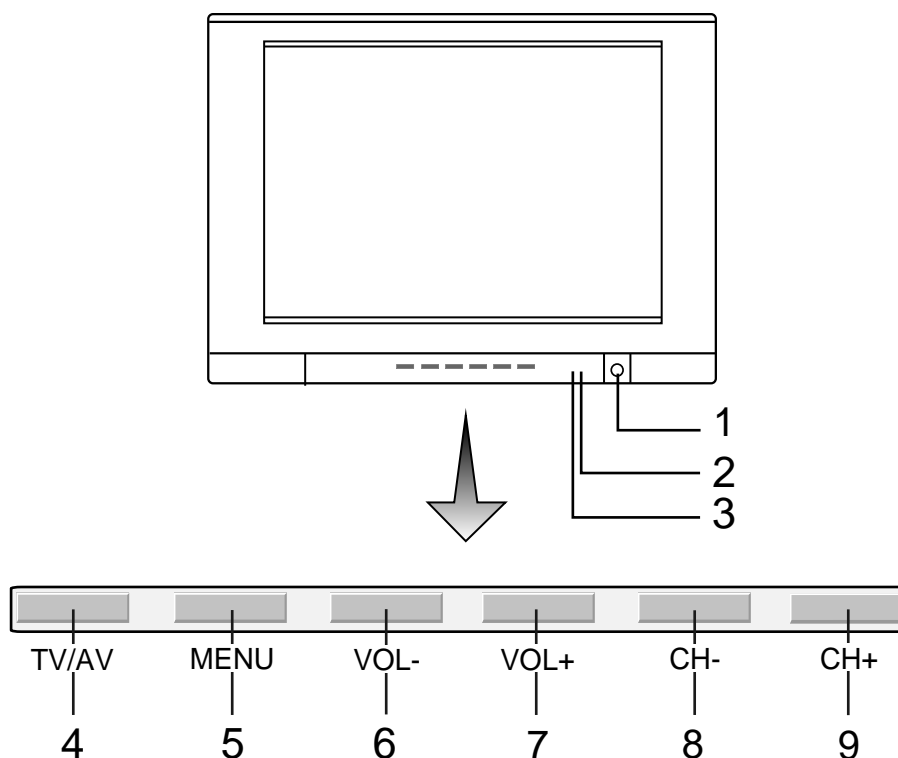

1. Power Switch
2. Remote sensor.
3. Indicator.
4. AV/TV button: Video input select.
5. MENU button: To enter into menu operation.
6. VOL- button: volume down adjust; menu item adjust.
7. VOL+ button: volume up adjust; menu item adjust.
8. CH- button: channel down select; menu item select.
9. CH+ button: channel up select; menu item select.

Back view

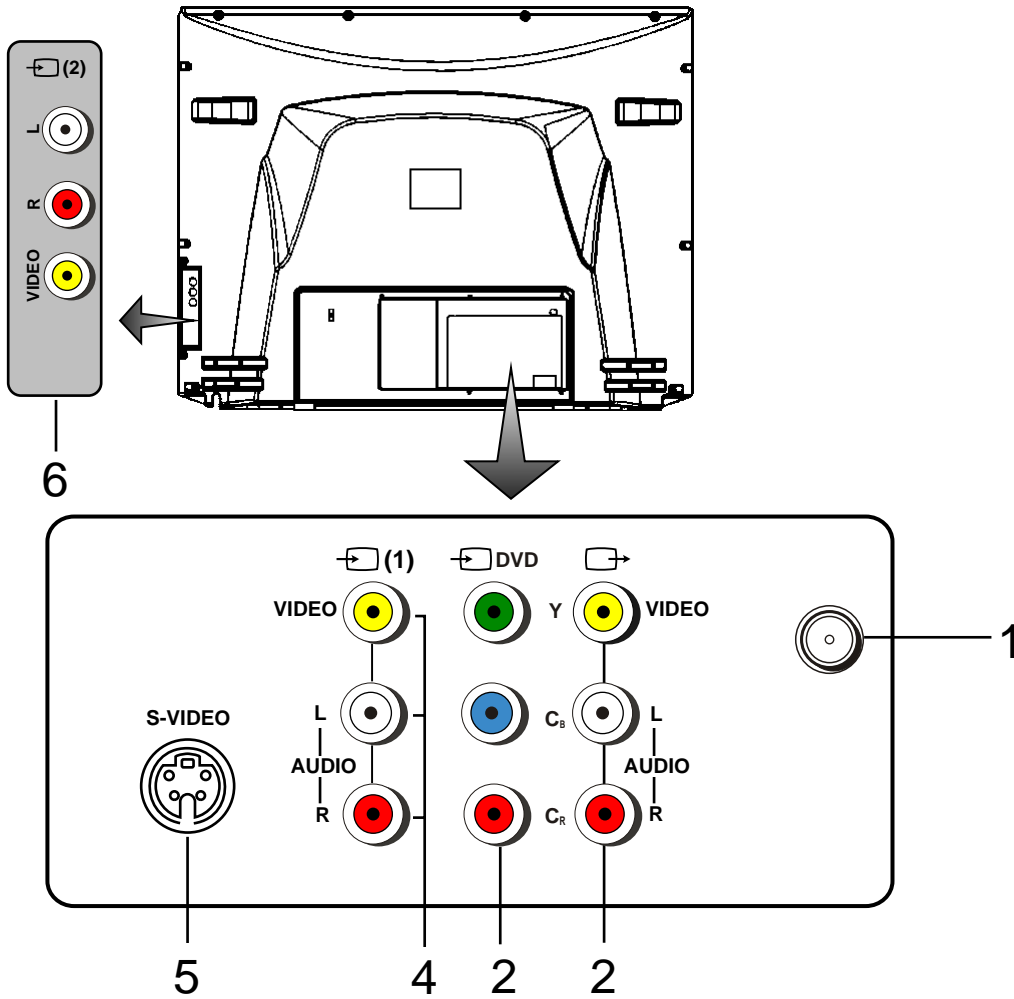

1. Antenna input
2. AV output (VIDEO, AUDIO L, R)
3. DVD input (YCbCr, AUDIO L, R)
4. AV1 input (VIDEO, AUDIO L, R)
5. S-VIDEO input
6. AV2 input (VIDEO, AUDIO L, R)



# Identification of Controls (continued)

## Remote control

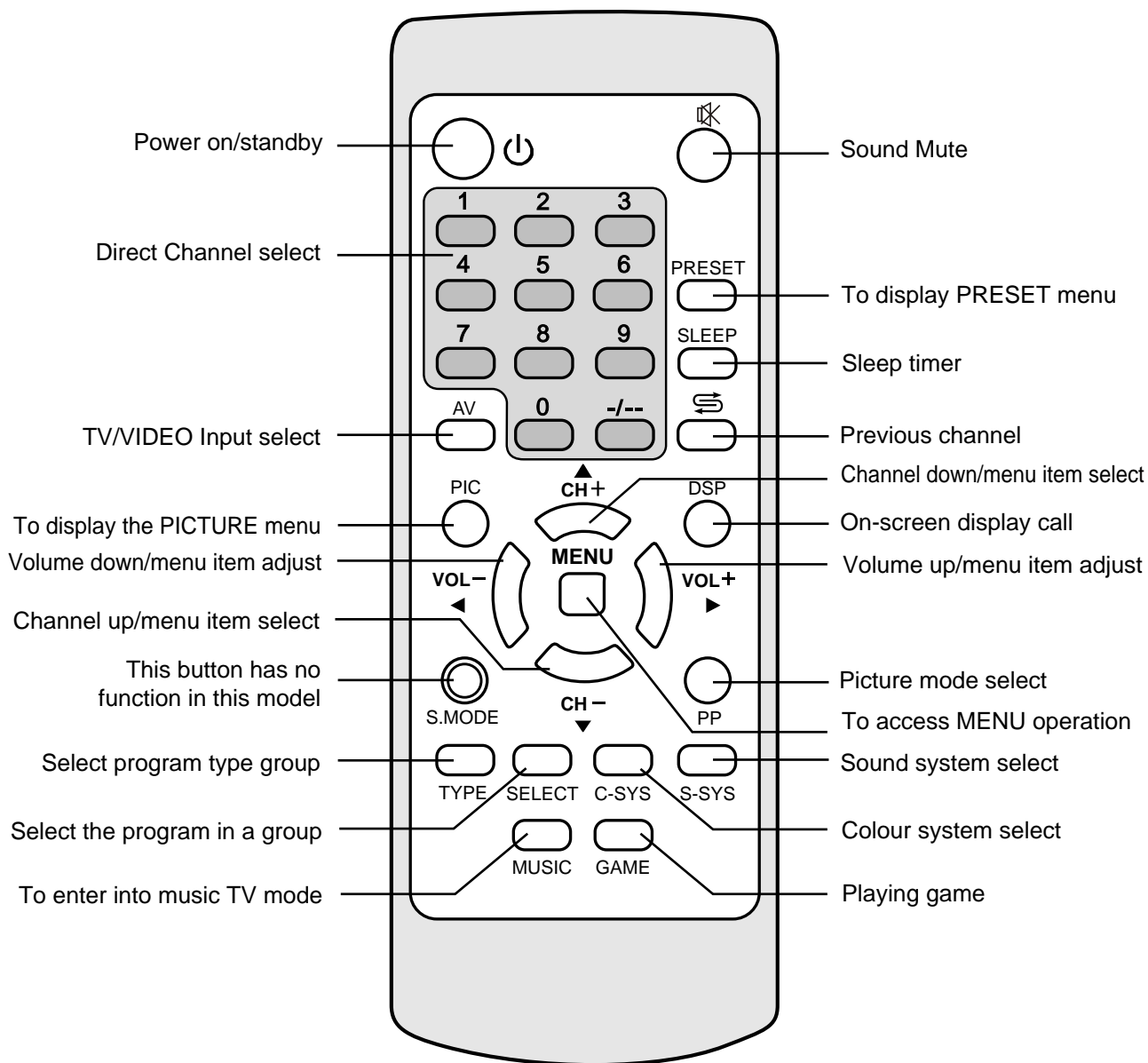

## Battery Installation

Please install the batteries before using the remote control.

**1** Open the battery cover.

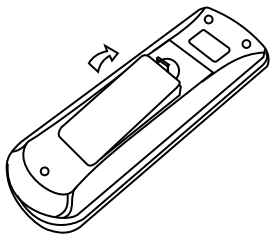

**2** Install two "AA" batteries matching the +/- polarities of the battery to the +/- marks inside the battery compartment.

**3** Replace the battery cover.

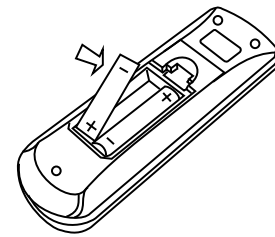

## Effective range of the remote control

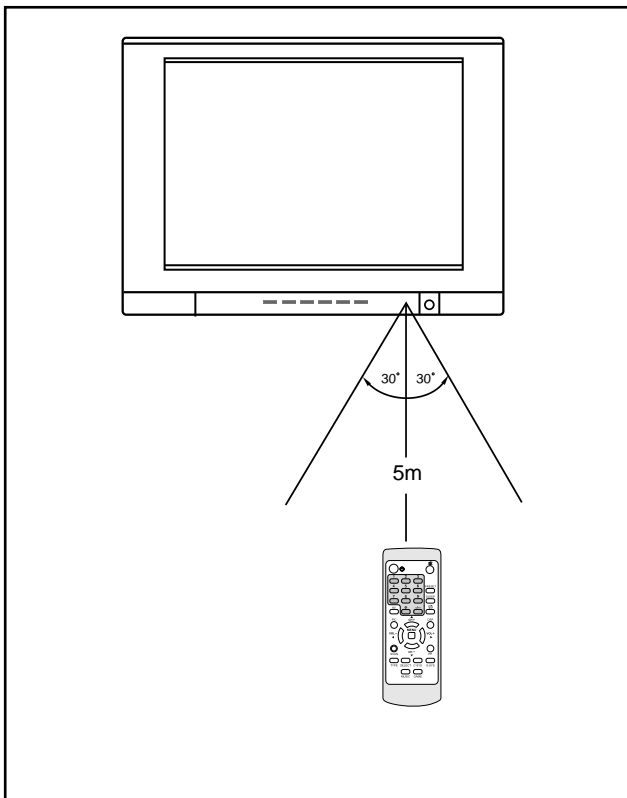

### ! Notes:

1. There should be no obstacle between the TV and the transmitter.
2. Use the remote control within the effective range as the above figure.
3. If the remote control does not work, please check whether the batteries are exhausted or the polarity is wrong.
4. When direct sunlight, and incandescent lamp, fluorescent lamp or any other strong light shines on the remote sensor of the TV, the remote operation may be unstable.
5. When the remote control will not be used for a long period of time or when the batteries are worn out, remove the batteries.
6. Do not drop or dampen the remote control.
7. Do not disassemble the remote control.

# Installation

## Connecting antenna

Optimum reception of colour requires a good signal and will generally mean that an outdoor antenna must be used. The exact type and position of the antenna will depend upon your particular area.

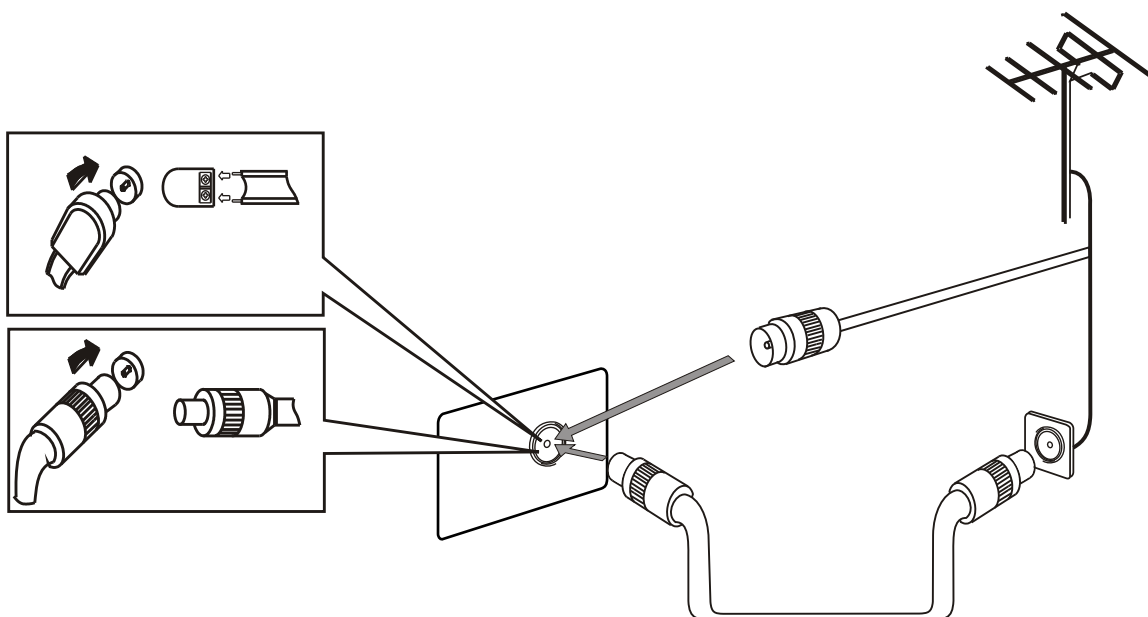

### ! Notes:

Turn off the power first, when you connect an outdoor antenna to the antenna input terminal. When installing an outside antenna system, extreme care should be taken to keep from touching power lines or circuits as contact with them might be fatal. In thunder and lightning weather, please disconnect the outdoor antenna to avoid thunder/lightning strike.

## Connecting video and audio equipment

This TV set provides 2 groups of AV input terminals (including 1 group of DVD and S-Video input terminals) for your convenient connection to VCR, DVD or other video equipment to enjoy the high quality picture.

Please refer to the owner's manual of the equipment to be connected as well.

### Connecting the rear AV and DVD input terminals.

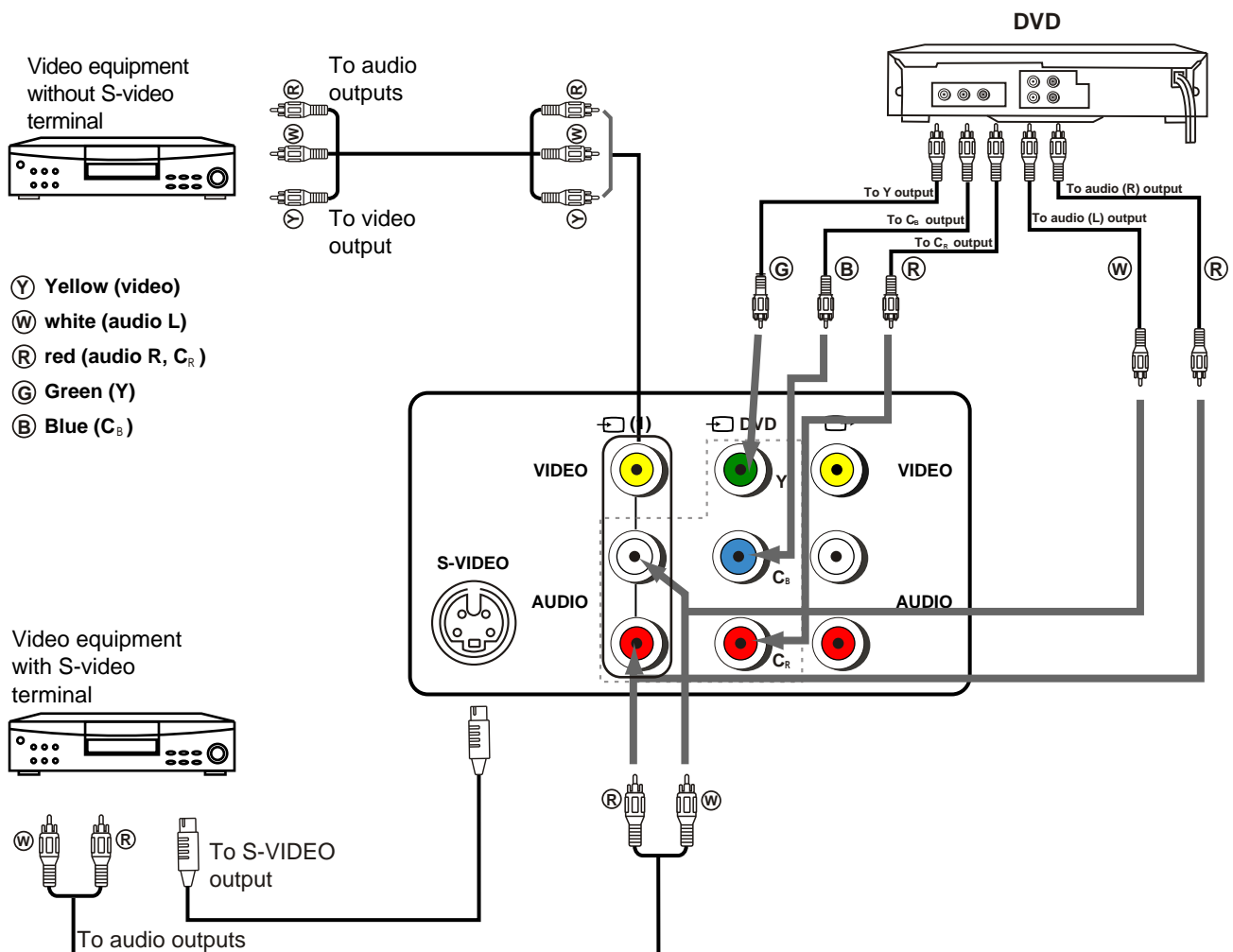

### ! Notes:

The S-VIDEO input terminal has priority over AV1 VIDEO terminal. The DVD terminal has priority over S-VIDEO input terminal. If you want to use equipment connected to S-Video terminal, please disconnect any plug from DVD terminal. If you want to use equipment connect to AV1 VIDEO terminal, please disconnect any plug from DVD and S-VIDEO terminal.

## Connecting the side AV input terminals

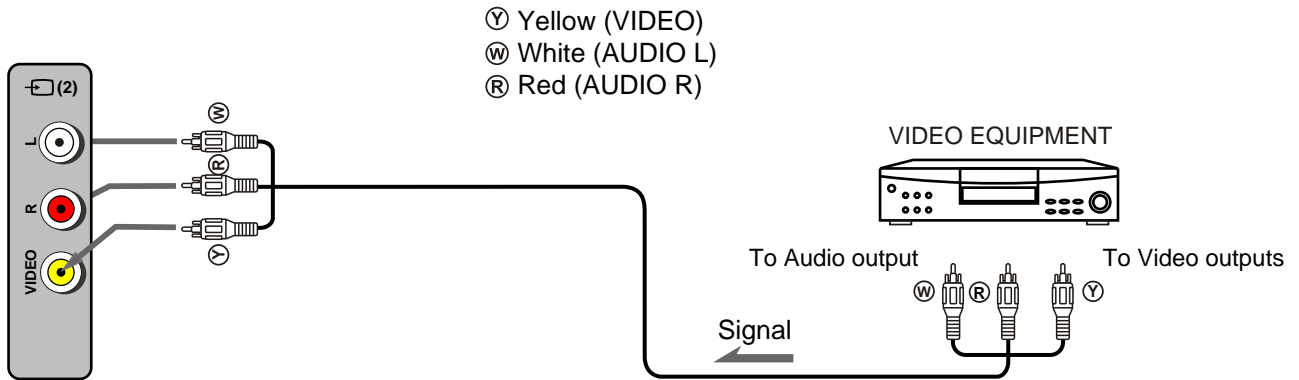

## Connecting the AV output terminals

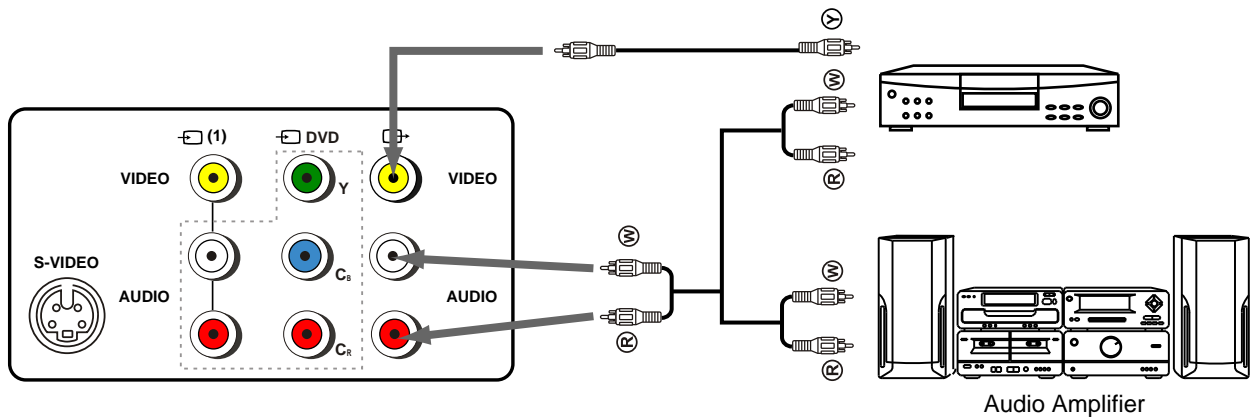

# Menu Introduction

Press the **MENU** button repeatedly to select the screen display as below. In menu operation, press **CH+/-** to select item, press **VOL+/-** to adjust selected item.

The PICTURE menu

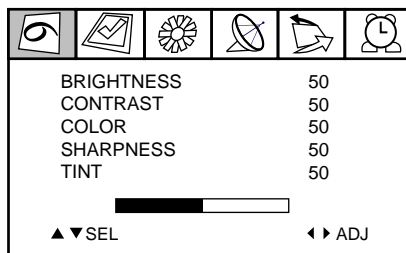

The SYSTEM1 menu

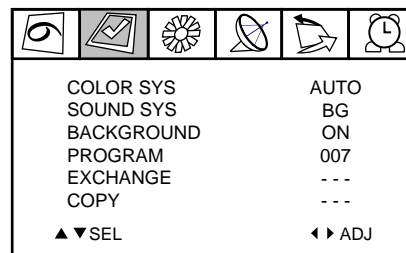

The SYSTEM2 menu

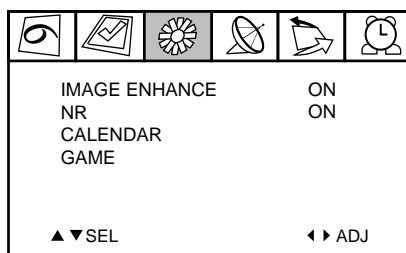

The PRESET menu  
(TV mode only)

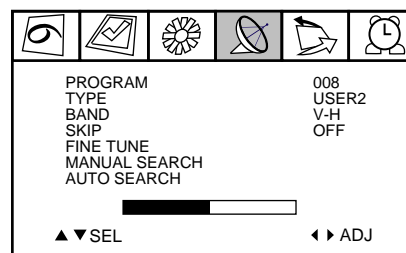

The CLOCK menu

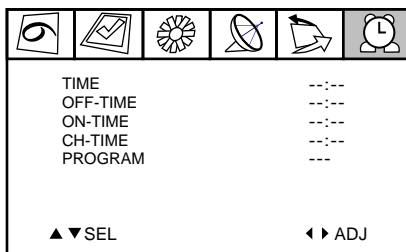

# Turning On/Turning Off

## Turning On

- 1 Press the **MAIN POWER SWITCH** to turn on the TV set.
- 2 If the TV set is in **STANDBY** mode, press  , **CH+/-** or **0-9** (one digit only) on the remote control, then the TV set is turned on.  
When the remote control is not at your hand, you can also press the **CH+/-** buttons on the TV set to turn on the TV.



### Note:

If there is no input signal to the TV when the TV is on, blue background will appear on the screen (when the **BACKGROUND** is set to **ON**). After 10 minutes if there are still no TV signals to the TV, it will access standby mode automatically.

---

---

## Turning Off

- 1 Press the **MAIN POWER SWITCH** on the TV set if you want to cut off the power completely.
- 2 If you want to turn off the TV set temporarily, press the button  on the remote control and the TV is in **STANDBY** mode.



### Notes:

*There are three kinds of Auto-Power-off function:*

1. When there is no input signal for 10 minutes.
2. Sleep-timer function.
3. Off-timer function.

*Last-Mode-Memory:*

When you turn off the set, the last TV mode, picture/sound setting and preset channels all are memorised, Therefore, next time you turn on the TV, the TV will work in the previous setting mode.

If you directly pressed the main power switch on the TV set to turn it off, you can press the main power switch to turn on the TV set.

If you press the main power switch to turn off the when in standby mode, you must do as **turning on-2** to turn on the TV.

# Presetting programs

Firstly, use the Auto search function to preset all active channels in your area automatically. Then arrange the preset channels with the manual search and program edit functions.

## Auto Search

Press the **MENU** button to select **PRESET** menu.

Press **CH+/-** to select **AUTO SEARCH**.

Press **VOL+/-** and the TV set starts Auto channel preset. All active channels will be preset and stored into the memory automatically. After presetting, the TV will display the first channel.

During the process of Auto channel preset, pressing the **MENU** button will stop the process.

**!** **Note:** Before you start Auto Search, we recommend you to set a proper Sound system and Colour system according to your local area.

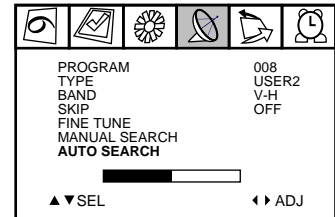

## Manual Search

If desired channel can not be preset by Auto search or if you would like to preset channels to specific position numbers one by one, use manual search function.

Access the **PRESET** menu, then select **PROGRAM** item by **CH+/-** and set the desired channel number (from 0~199) by **VOL+/-** or **Digit** buttons.

Press **CH+/-** to select **MANUAL SEARCH** item. Press **VOL+** button, the set searches towards higher frequency. Press **VOL-** button, the set searches towards lower frequency. The search stops when a program is found and this program will be stored in the specified position number.

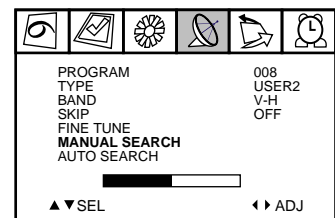

You can use band selection to quicken search process. Select **BAND** item and press **VOL+/-** buttons. The band switches among V-L, V-H and UHF. Then select **MANUAL SEARCH** item and press **VOL+/-** buttons to start manual search.

Repeat the above steps if you want to store another program in other position number.

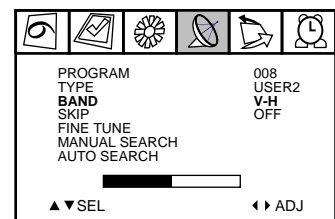



## Presetting programs (continued)

### Fine Tuning

When picture and sound's effect of a channel is poor (for example: one or two CATV channel's picture and sound are not standard), you can correct them by making use of Fine tuning.

Access the **PRESET** menu, then select **PROGRAM** item by **CH+/-** and set the desired channel number (from 0~199) by **VOL+/-** or **Digit** buttons.

In the menu, select **FINE TUNE** item, then press and hold **VOL+/-** buttons until the best picture and sound are obtained.

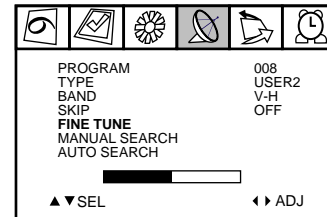

# Editing programs

## Channel skipping

After presetting the channels, you can skip unnecessary position numbers so that only the channels you want are selected.

Access the **PRESET** menu, then select **PROGRAM** item by **CH+/-** and set the desired channel number (from 0~199) by **VOL+/-** or **Digit** buttons.

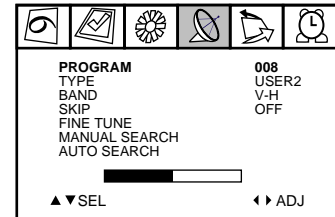

In the menu, please select **SKIP** item and press **VOL+/-** buttons to select **ON**.

Now the selected channel will be skipped when you browse channels by **CH+/-** buttons.

If the SKIP is set to ON, when you select the channel by Digit buttons, the program number displayed on the screen is purple and a " \* " symbol can be seen.

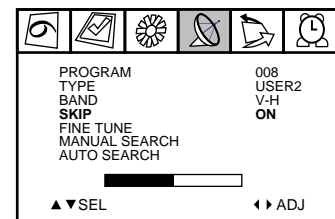

To restore a skipped channel, please select the skipped channel number by digit buttons. Then enter into the **PRESET** menu to select **SKIP** item and set it to **OFF**.

## Classifying programs

You can classify the programs as six types: USER1, USER2, NEWS, SPORTS, MOVIE, TELEPLAY. The function can help you select program more rapidly.

Access the **PRESET** menu, then select the program number. Press **CH+/-** buttons to select **TYPE** item. Press **VOL+/-** buttons to select the program type.

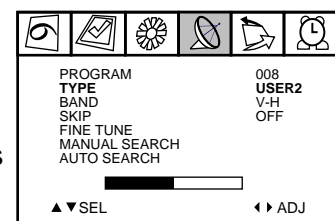

The program types are defined by yourself. The USER1 and USER2 types can be used to store the programs that the user often watches or is interested in.

# Editing programs (continued)

## Channel exchange/copy

After channel presetting, you can edit the programs by using the channel exchange and channel copy functions.

Press **MENU** button repeatedly to access the **SWAP** menu.

Select **PROGRAM** item and select a channel number **A** by Digit buttons.

COLOR SYS					AUTO
SOUND SYS					B/G
BACKGROUND					ON
PROGRAM					007
EXCHANGE					---
COPY					---
▲▼SEL		◀▶ADJ			

Select **EXCHANGE** item and press **Digit** buttons to set another channel number **B** that you would like to exchange with the program number which is displayed in the **PROGRAM** item. Then press **VOL+/-** buttons to confirm.

Now the programs of the two channels are exchanged.

COLOR SYS					AUTO
SOUND SYS					B/G
BACKGROUND					ON
PROGRAM					007
EXCHANGE					008
COPY					---
▲▼SEL		◀▶ADJ			

Select **COPY** item and press **Digit** buttons to select a channel number **C**. Then press **VOL+/-** buttons to confirm.

Now the program in channel **A** will be copied to channel **C**.

COLOR SYS					AUTO
SOUND SYS					B/G
BACKGROUND					ON
PROGRAM					007
EXCHANGE					---
COPY					008
▲▼SEL		◀▶ADJ			

## Setting colour/sound system

If the picture's colour or sound is abnormal, you can adjust colour or sound system as follows.

Press **C-SYS** button repeatedly and the colour system will be switched between **AUTO**, **PAL**, **N3.58** and **N4.43**. You can select a proper colour system.

Press **S-SYS** button can select sound system. In this model, the sound system is B/G and there is no need to adjust it.

When you press **C-SYS** or **S-SYS** button, the screen displays as shown on the right.

9	
AUTO	
B/G	

You can also access the **SYSTEM1** menu which is shown on the right and adjust the **COLOR SYS** item and the **SOUND SYS** item to set the colour system and the sound system.

COLOR SYS					AUTO
SOUND SYS					B/G
BACKGROUND					ON
PROGRAM					007
EXCHANGE					---
COPY					---
▲▼SEL		◀▶ADJ			

# Selecting Channel/input signal

## Selecting channel

### 1 Use **Digit** buttons

#### To select one-digit channel

Press **--/--** button to display "--".



Press 0-9 direct channel selector.

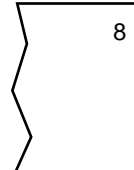

#### To select two-digit channel

Press **--/--** button repeatedly to display "--".

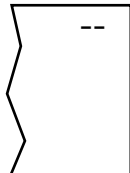

Press 1-9 buttons.

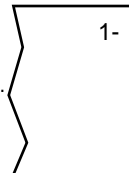

Press 0-9 buttons.

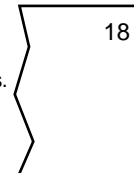

#### To select three-digit channel

Press **--/--** button repeatedly to display "1--".

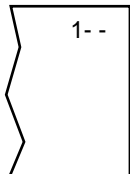

Press 0-9 buttons.

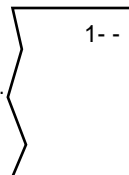

Press 0-9 buttons.

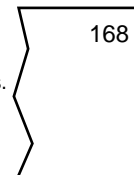

**Note:** The maximum channel number is 199, the set does not act if the channel number you input is out of the range of 0~199.

### 2 Use **CH+/-** buttons

Press **CH+** button, the channel number increases;

Press **CH-** button, the channel number decreases.

### 3 Use previous channel button

Press  button to switch between the current channel and previous channel.

### 4 Use **TYPE** and **SELECT** buttons

Press **TYPE** button to select the program type group that you want to watch.

Press **SELECT** button repeatedly, and the program is switched among the type group.

## Selecting the external Input Signal

### 1 Press **AV** button repeatedly, the screen displays input signal source **AV1 (S-VIDEO, DVD)** or **AV2**. Select the input signal source you need.

### 2 To return to TV mode, you can press **AV** button or **0-9** buttons.

# Adjusting the picture/sound

## Adjusting the picture

- Using the **PP** button:  
You can press **PP** button to select the desired picture mode: **MILD, STANDARD, NATURE, CUSTOM, COLORFUL.**

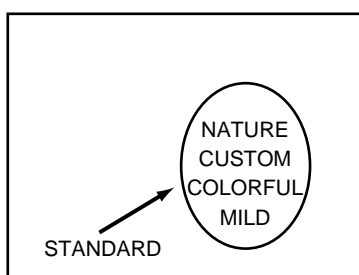

Mode	Picture quality
MILD	Soft and moody picture
STANDARD	Standard picture
NATURE	Normal picture
COLOURFUL	Bright and dynamic picture
CUSTOM	The picture quality you set

- Using the **PICTURE** menu:  
Press **MENU** button or **PIC** button to access the **PICTURE** menu.  
Press **PIC** button repeatedly or press **CH+/-** buttons to select item upwards or downwards.  
Press **VOL+/-** buttons to adjust selected item.

Item	VOL-	VOL+
CONTRAST	weaker	stronger
BRIGHT	darker	lighter
COLOR	paler	deeper
SHARPNESS	softer	sharper
TINT	purplish	greenish



### Notes:

- The item **TINT** is for **NTSC** only.
- The above parameters may be different in different models.

## Adjusting the sound

- Use **VOL+/-** buttons  
Press **VOL+** button to increase the volume.  
Press **VOL-** button to decrease the volume.
- Use button  
Press button to mute the sound completely and the screen displays .  
Press button again to restore and the **VOLUME** bar appears.

# Clock Setting

Press **MENU** button repeatedly to access the **CLOCK** menu.

## Current time setting

Select **TIME** item.

Press **VOL-** button to set the hour (0~23).  
Press **VOL+** button to set the minute (0~59).

**!** **Note:** The **ON-TIME** and **OFF-TIME** can be set only after you finish setting the **TIME** item.

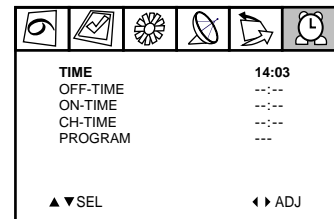

## Off timer setting

Select **OFF-TIME** item.

Set the OFF time. Press **VOL-** to set the hour (0~23).  
Press **VOL+** to set the minute (0~59).

The TV set in working mode goes to **STANDBY** mode automatically when the OFF time elapses.

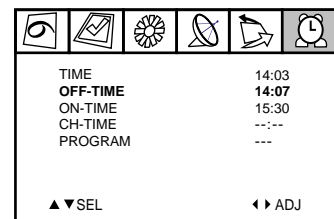

## On timer setting

Select **ON-TIME** item.

Set the ON time. Press **VOL-** to set the hour (0~23).  
Press **VOL+** to set the minute (0~59)

In **STANDBY** mode, the TV set auto turns on when your preset ON time elapses.

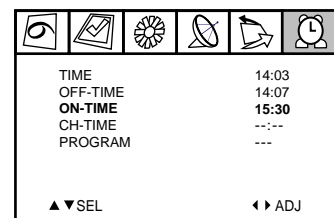

**!** **Notes:** Once the function of **ON-TIME** or **OFF-TIME** fulfil, you need to set the **ON-TIME** or **OFF-TIME** again if you want to use this function next time

# Clock Setting

## Setting channel timer

Select **CH-TIME** item.  
Set the CH-TIME. Press **VOL-** to set Press **VOL+** to set minute (0~59).

TIME	14:02				
OFF-TIME	14:07				
ON-TIME	15:30				
<b>CH-TIME</b>	<b>16:21</b>				
PROGRAM	- - -				
▲▼SEL		◀▶ADJ			

Select **PROGRAM** item. Set the channel number by **Digit** or **VOL+/-** buttons.

TIME	14:02				
OFF-TIME	14:07				
ON-TIME	15:30				
CH-TIME	16:21				
<b>PROGRAM</b>	<b>008</b>				
▲▼SEL		◀▶ADJ			

The TV set will switch to the preset channel when the **CH-TIME** elapses.

# System Setting

## Background Setting

With the background function **ON**, when no signal is being received, a preset background and customer's logo will appear.

Access the **SYSTEM1** menu. Press **CH+/-** buttons to select **BACKGROUND** item.

Press **VOL+/-** buttons to select **ON** or **OFF**.

COLOR SYS	SOUND SYS	<b>BACKGROUND</b>	PROGRAM	EXCHANGE	COPY
AUTO	B/G	<b>ON</b>	007	---	---
▲▼SEL			◀▶ADJ		

## Colour/sound system setting

Press **C-SYS** or **S-SYS** button on the remote control repeatedly to set colour system or sound system.

You can also access the **SYSTEM1** menu. Press **CH+/-** to select **COLOR SYS** item or **SOUND SYS** item.

Press **VOL+/-** buttons to select colour system or sound system.

<b>COLOR SYS</b>	SOUND SYS	BACKGROUND	PROGRAM	EXCHANGE	COPY
<b>AUTO</b>	B/G	ON	007	---	---
▲▼SEL			◀▶ADJ		

COLOR SYS	<b>SOUND SYS</b>	BACKGROUND	PROGRAM	EXCHANGE	COPY
AUTO	<b>B/G</b>	ON	007	---	---
▲▼SEL			◀▶ADJ		



## Other functions introduction

### Game introduction

There is a built-in game (Box man) for you to play.

Press **GAME** button to access game interface.

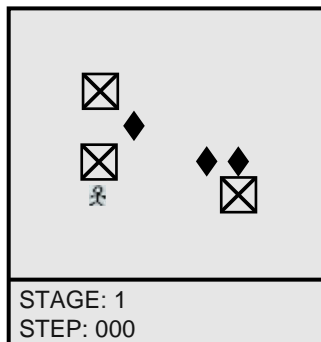

Description of icons:

- ☒ :the man you control.
- ☒ :the box to push.
- ◆ :the destination to push the box to.
- ▣ :the wall.

On the screen, press **PP** button select **STAGE**, then you can start game.

The player should control the man to push the box just push, not pull) to the destination within the wall by using **CH+**, **CH-**, **VOL+**, **VOL-** buttons.

Press **GAME** button to exit game, if you want to play again then press **GAME** button again.

# Other function introduction

## Image Enhance setting

With built-in image enhance circuit you can use the function to improve the visibility of details near black.

Access the **SYSTEM2** menu. Press **CH+/-** buttons to select **IMAGE ENHANCE** item.

Press **VOL+/-** buttons to select **ON**, the image enhance is available.

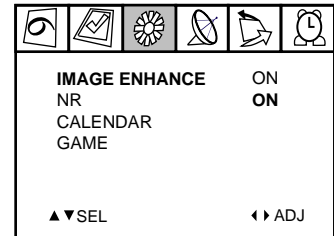

## Noise Reduction setting

If the signal being received is weak and the picture is blurry, active this function to improve the picture quality.

Access the **SYSTEM2** menu. Press **CH+/-** buttons to select **NR** item.

Press **VOL+/-** buttons to select **ON**.



## Calendar

Access the **SYSTEM2** menu. Press **CH+/-** buttons to select **CALENDAR** item.

Press **VOL+/-** buttons to access calendar interface.

Press **CH+/-** buttons to change the **year**. Press **VOL+/-** buttons to change the **month**.

The calendar is from 1990 to 2089.

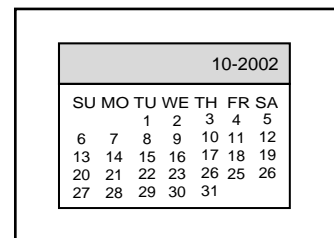

## Other functions introduction

### Setting music TV function

If you only want to listen to the music, you can press **MUSIC** button and the screen displays **MUSIC TV**. Five seconds later, the screen is blank while the sound is normal. Press any button on the remote control to exit **MUSIC** mode.



MUSIC TV

### Sleep timer

Press **SLEEP** button repeatedly to set sleep time from 15 minutes to 120 minutes.

When the sleep time elapses, the TV set goes to STANDBY mode automatically.



 90

If you want to cancel Sleep timer, press and hold **SLEEP** button until the screen displays the icon --.



 --

### Child lock

Press and hold **MUSIC** button until the screen displays a lock icon. Now the TV set is in **Child lock** state. The screen is blue and most of the buttons are useless.

If you want to resume, press and hold **MUSIC** button again until the lock icon disappears.



# Troubleshooting Guide

*Before calling service personnel, please check the following chart for a possible cause to the trouble you are experiencing.*

Symptoms	Check the following items
Power is not turned on.	<ul style="list-style-type: none"> <li>❑ Be sure the power cord is plugged in.</li> </ul>
Poor colour, poor tint.	<ul style="list-style-type: none"> <li>❑ Contrast, colour, tint are not correctly adjusted.</li> </ul>
Spots appear on the screen.	<ul style="list-style-type: none"> <li>❑ Possible interferences of automobiles, motorcycle, trolley bus, neon lamps, etc.</li> </ul>
Stripes appear on the screen.	<ul style="list-style-type: none"> <li>❑ Possible interference of electronic interference from another TV set, a computer, an electronics game machine, a broadcast station, etc.</li> </ul>
Double images or "ghosts".	<ul style="list-style-type: none"> <li>❑ This may be caused by reflections from nearby mountains or buildings.</li> <li>❑ Check the antenna direction.</li> </ul>
Snowy picture.	<ul style="list-style-type: none"> <li>❑ It is possible that the aerial "lead-in" is damaged or comes off.</li> <li>❑ Check the antenna direction.</li> </ul>
Remote controller does not work.	<ul style="list-style-type: none"> <li>❑ The batteries may be worn out.</li> <li>❑ The batteries may be installed with their polarity reversed.</li> </ul>
TV cabinet creaks.	<ul style="list-style-type: none"> <li>❑ Even if the picture or the sound is normal, changes in room temperature sometimes makes the TV cabinet expand or contract, making a noise. This does not indicate a malfunction.</li> </ul>
Unevenness in colour in some parts of the screen.	<ul style="list-style-type: none"> <li>❑ When the set is switched on, do not shift or move the set around. Sometimes it may develop an unevenness in colour in some parts of the screen. This can be eliminated by switching off the set with the POWER switch and wait for 10 minutes before switching on again.</li> </ul>
No picture and most of the buttons are useless.	<ul style="list-style-type: none"> <li>❑ It is possible that the TV set is in child lock mode.</li> </ul>
Black screen but the sound is normal.	<ul style="list-style-type: none"> <li>❑ It is possible that the TV set is in music TV mode.</li> </ul>
AV playback interference.	<ul style="list-style-type: none"> <li>❑ It is possible that both of the DVD and S-Video terminals are connected.</li> </ul>

# Specifications

Power Supply: AC 240V, 50Hz  
Power Consumption: 140W  
Dimensions (mm): 760 (W) x 595 (H) x 490 (D)  
Weight (kg): 36  
CRT: 68cm

## TV system & channel range

System	VHF	UHF	CATV
PAL-B/G	2-12	21-69	X~Z+2,S1~S41

System: PAL-BG, NTSC (AV)  
Sound output: 4W x 2  
Accessories: Remote controller x 1

 Design and specifications are subject to change without notice.

PALSONIC CORPORATION PTY LTD  
1 JOYNTON AVENUE  
WATERLOO NSW 2017 AUSTRALIA  
TEL: (02) 9313 7111  
FAX: (02) 9313 7555  
[www.palsonic.com.au](http://www.palsonic.com.au)

**PALSONIC CUSTOMER SERVICE  
TELEPHONE  
AUSTRALIA: 1300 657 888**

5944033370  
XMH Ver 1.0

## Free Manuals Download Website

<http://myh66.com>

<http://usermanuals.us>

<http://www.somanuals.com>

<http://www.4manuals.cc>

<http://www.manual-lib.com>

<http://www.404manual.com>

<http://www.luxmanual.com>

<http://aubethermostatmanual.com>

Golf course search by state

<http://golfingnear.com>

Email search by domain

<http://emailbydomain.com>

Auto manuals search

<http://auto.somanuals.com>

TV manuals search

<http://tv.somanuals.com>