

Palsonic

Instruction manual



Video cassette recorder VCR 2120

PALSONIC CORPORATION PTY LTD
1 JOYNTON AVENUE
WATERLOO NSW 2017 AUSTRALIA
TEL:(02)9313 7111
FAX:(02)9313 7555
www.palsonic.com.au

**PALSONIC CUSTOMER SERVICE
TELEPHONE
AUSTRALIA:1300 657 888**

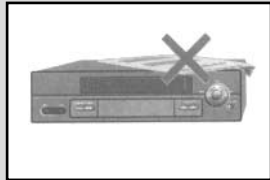
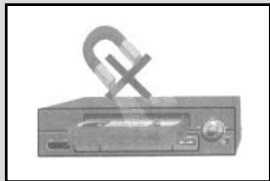
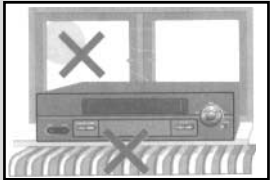

Please keep the video machines guarantee card and receipt safe for warranty purposes.

Precautions

- ◆ Read carefully through this manual to familiarize yourself with this high-quality video recorder.
- ◆ Make sure the rating of your household electricity supply matches that shown on the back of the video recorder.
- ◆ Refer to this chapter and the "Initial installation" chapter to help you install and adjust your video recorder.

Do not ...

- ... expose the video recorder to high levels of humidity and heat, to avoid the risk of fire and electric shock.
- ... open the video recorder. Have a qualified technician carry out repairs.
- ... connect the video recorder to the power supply if you have just moved it from a cold to warm environment. This can result in condensation inside the recorder and cause serious damage to the machine and cassettes. Wait around two hours to allow it to reach room temperature.

Make sure ...

- ... the recorder is placed on a steady, flat surface.
- ... you place the recorder where there is good ventilation all around.
- ... you clean the recorder only with a soft, lint-free cloth; do not use aggressive or alcohol-based cleaning agents.
- ... you disconnect the power supply if the recorder appears to be working incorrectly, is making an unusual sound, has a strange smell, has smoke emitting from it or liquids have got inside it. Have a qualified technician check the recorder.
- ... you disconnect the power supply and aerial if you will not be using the recorder for a long period or during a thunderstorm.

For your own safety!



- ◆ There are no components in this video recorder you can service or repair yourself
- ◆ Do not open the case of the video recorder. Only allow qualified personnel to repair or service your set.



- ◆ This video recorder is designed for continuous operation. Switching it off does not disconnect it from the mains (stand-by). To disconnect it from the mains, you have to unplug it.
- ◆ Recording any copyright protected material may infringe a copyright.

Before doing anything with the machine, please read the chapter "Initial installation".

W O R T H k n o w i n g

Contents

Controls

The remote control unit	2
The machine, On screen display	3

Initial installation

Connecting up the video recorder, Fitting the remote control's batteries .	4
Setting up the video recorder	5

Playing cassettes

Playing back	6
Still, Variable picture search, Variable slow motion, Accessing new recordings (index scan), CM Skip	7

Recording cassettes

Simple recording	8
One touch recording (OTR)	9

More functions

Normal timer recording	10
Timer Review - changing and erasing, Setting time and date	11
Clock/Counter display, Remaining time and Cassette length, Accessing counter zero position, Resetting the counter to zero	12
Menu languages, Child lock, Cassettes, and	13

Tuning in new stations

Tuning	14
Station names	15
Sorting programme locations, Clearing programme locations	16

Connections and copying

To the TV via antenna cable (if you are not using a RCA cable)	17
Copying, Assembling	18

Appendix

Brief instruction for experienced users	19/20
Before you ask a specialist	21
Index, Technical data	22



- ◆ On the following pages, the pictures show the buttons you press on the remote control to perform the function, and what you should see in the On Screen Display or machine display (if present)

CONTROLS

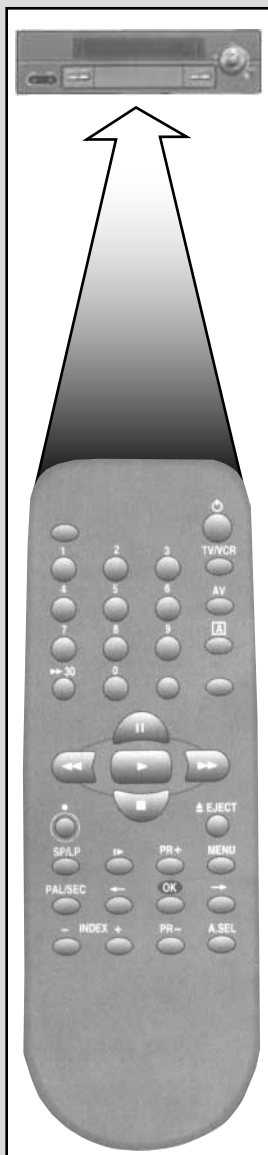

- ◆ The remote control is the principle means of control, but the main playback and record functions are also available on the front of the machine.
- ◆ Press any button **to turn on the power.**

The remote control unit



power on/off



This button is not available for this set



number buttons to select programmes (stations) or to type in numbers



This button is not available for this set



a button for selecting input sources for recording:
TV stations - input sockets



clock/counter on-screen display



This button is not available for this set



This button is not available for this set



CM skip button to cue the tape for 30 seconds



pause (record), still (playback)



playback start



playback stop



rewinding/fast forwarding a cassette from stop, or picture search backwards/forwards from playback mode



the record or OTR button
(One Touch Recording means each time you press the button recording is extended by 30 minutes)



to eject the cassette



a button that doubles the maximum recording time for very long recordings



the variable slow motion button



the menu controls, programme (station) selection
(PR +/-)



to search the beginnings of records (index)



This button is not available for this set



This button is not available for this set



The buttons to use are marked on the following pages.

◆ Press any button to turn on the power.

CONTROLS

The machine



standby/on



playback stop and ejecting the cassette



front input sockets for connecting a camcorder

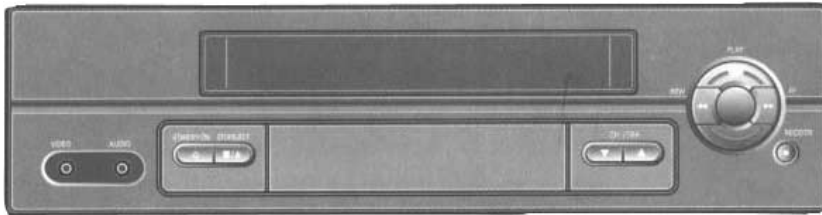

programme (station) selection



recording or OTR

(One Touch Recording means each time you press the button recording is extended by 30 minutes)



rewinding / fast forwarding a cassette from Stop, or picture search backwards / forwards from playback mode.



playback start

On screen display

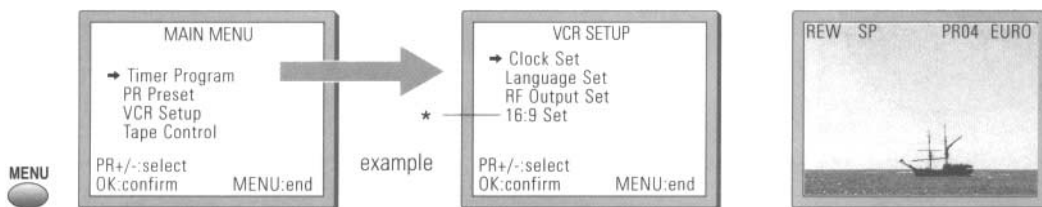

The video's menu system gives you easy-to-understand access to the less used functions such as tuning to stations, clock setting and more.

"Tape Control" Menu appears only when a tape is in the VCR.



The menus show you which button to press for the next step.



In addition, some other functions appear on screen temporarily.

* Though the "16:9 Set" is displayed on the screen, this function is not available for this set.

Initial INSTALLATION

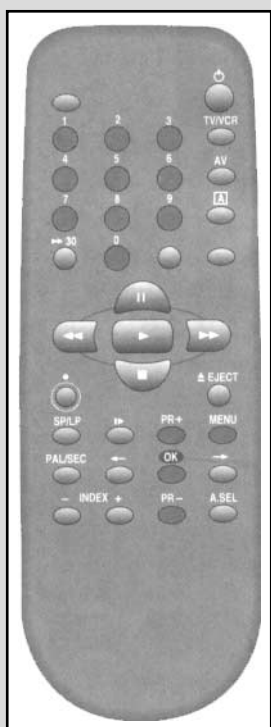

Place your video

- ◆ horizontally on a flat, steady base so that air can circulate around it for ventilation
- ◆ away from humidity and heat, magnetic fields, such as those from loudspeakers etc and with no heavy objects placed on top

Connecting up the video recorder

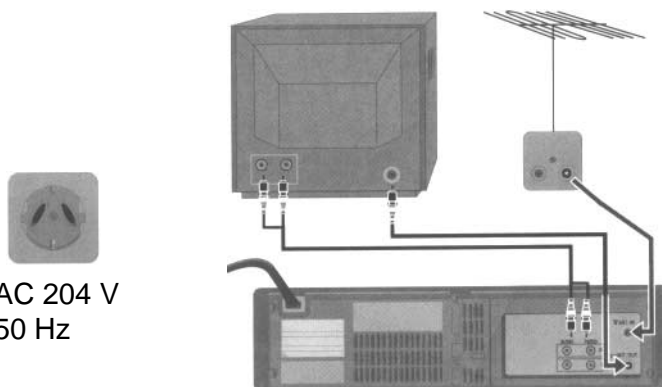

AC 204 V
50 Hz

- ◆ Unplug the aerial cable from your TV and plug it into the "ANT.IN" socket of the video.
Plug the short coaxial cable provided into the "ANT.OUT" socket of the video and the aerial socket of the TV.
- ◆ Plug a RCA cable into the "RCA" socket of the video and the AV socket on the TV if available.
This connection will provide best picture and sound quality.
Ask your dealer for an appropriate cable if you do not have one.
Without a RCA cable, you need to follow the steps described under "If you are not using a RCA cable" (right page and page 17).
- ◆ Make sure the rating of the household mains supply matches the rating shown on the back of the video.
Now plug in the mains lead. The display of the video should now light.

Fitting the remote control's batteries

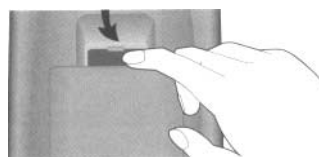
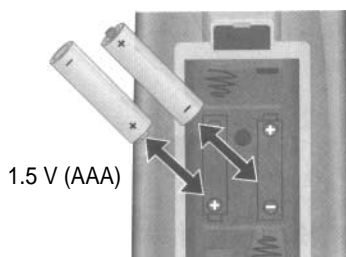

Fit the batteries as shown by the pictures in the bay.

- ◆ Protect your environment by returning used batteries to your dealer. Since batteries contain toxic substances they require special disposal methods.
- ◆ Make sure the batteries are always of the same type and age, and remove them from the remote control if you are not using it for a long period.

 The buttons to use are marked on the following pages.

Initial INSTALLATION

- ◆ Switch the TV on
- ◆ You can also start "Auto Search" in the menu "PR PRESET" → "Auto Search"
- ◆ To tune in **new stations** (manual tuning) and to enter station names see page 14- 16

Setting up the video recorder



You should see this picture the first time you switch on the TV and video



Choose your language



OK for "Auto Search"!

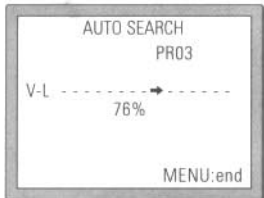

"AUTO SEARCH" tunes in all the stations you can receive in your country and...

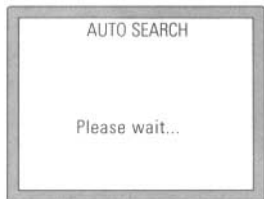

sorts them in an order common for your country

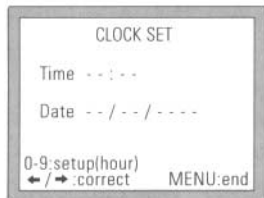

Then type in the current time and date

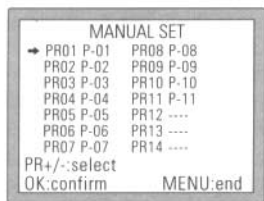

Should you wish the stations to have the same numbers as those used on the TV, follow the instructions in "Sorting programme locations" on page 16

Else exit the basic installation function and enjoy your video recorder.



- ◆ If you don't see this picture, because **you don't use a RCA cable**, search this picture now (CH 26) with the station tuning functions of your TV set (see its user manual)
- ◆  In case of interference problems on CH 26, type in an other transmission channel between 21 and 69 using the number buttons

PLAYING cassettes

- ◆ Your TV and your video recorder are switched on.
- ◆ To see the picture from your video, press the station button on the TV reserved for video input or the AV (Audio/Video) button

Playing back

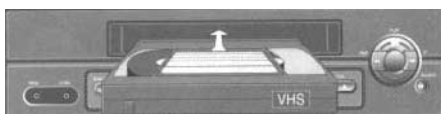

Load the cassette by pushing it smoothly and squarely into the cassette bay, with its windows pointing up.



Start playback.



Stop playback



Eject the cassette



Fast forward or rewind the cassette from stop

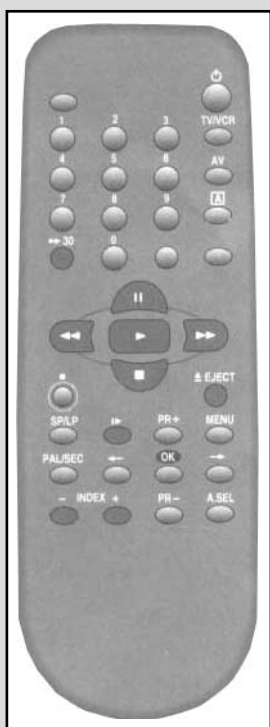

- ◆ When you load a **protected cassette** (e.g. pre-recorded film, see page 13) playback starts automatically.
- ◆ PLAY switches back to **normal playback**.
- ◆ During still, slow or search, you don't hear the **sound**.
- ◆ If the still picture is jittering, you can steady it by using the PR+/- buttons.
- ◆ You can reduce horizontal **interference stripes** resulting from inaccurate tracking (when playing tapes of poor quality or recorded on other machines) by using the PR+/- buttons during playback.
- ◆ After approx 5 minutes instill, the cassette plays back automatically.
- ◆ NTSC PLAYBACK on PAL TV, If you playback the tapes, which have been recorded on NTSC colour system, on this VCR, you can watch the pictures on a PAL TV.
- ◆ Clock / Counter / Remaining time - page 12.
- ◆ Auto Head Cleaning
This VCR has Auto Head Cleaner The video head will be cleaned automatically whenever loading or unloading the tape.



PLAYING

cassettes

Still



Still picture from playback.

Each press of the button advances the picture one frame.

"PLAY" blinks during still

PLAY switches back to normal playback

Variable picture search



Starting from playback you can control search speed in 2 steps either forwards (▶▶) or backwards (◀◀). Press repeatedly.



PLAY switches back to normal playback.

Variable slow motion



Starting from playback you can control slow motion speed in 6 steps (1/5, 1/10, 1/5, 1/30, 1/25, 1/20, 1/15, ...) Press repeatedly.

PLAY switches back to normal playback.

Accessing new recordings (index scan)

Access the beginning of recordings in the middle of the tape using the Index +/- function. The video recorder automatically sets an electronic marker (index) at the beginning of each recording. It is these markers which the Index +/- function detects.



Select INDEX + or INDEX - to search forwards or backwards.

The video will now wind to the beginning of the first recording, play it for about 6 seconds then wind on to the next one

When you see the recording you want, press PLAY.

CM Skip



If you press [CM Skip] button on the remote control, tape advances for 30 seconds segment.

RECORDING

c a s s e t t e s

- ◆ The TV stations on the video have been tuned in (page 5).
- ◆ The video is switched on.
- ◆ You can either watch the picture from the video on the TV by pressing the station button reserved for video input or the AV button, watch another TV station or switch off the TV altogether.

Simple recording

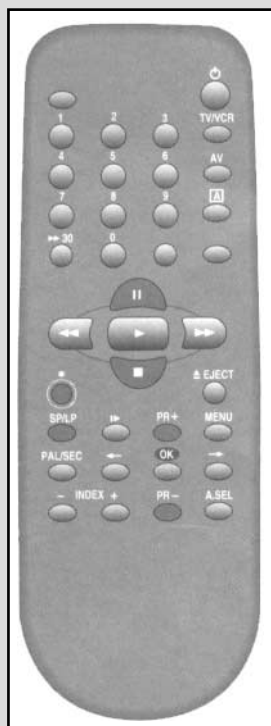

Load a cassette with its safety tab in place (see page 13)



19:37

Choose the station whose programme you want to record.



If the programme you wish to record is very long, double the possible recording time with "LP" (Long Play).



Up to eight hours with an E-240 cassette.



Start your recording.



If you wish to interrupt recording briefly - then continue.



"REC" blinks during this period.

- ◆ The video stops automatically, if pause exceeds five minutes.



Stop your recording.

21:30

RECORDING

c a s s e t t e s

- ◆ For timer recordings, clock, date, and stations must be set correctly
- ◆ Load a cassette with its safety tab in place (see page 13) and with sufficient free space for the recording

One touch recording - OTR



Choose the station you want and press the button once for every 30 minutes of programme you wish to record.

Up to ten hours are possible



- ◆ If you want to record from a **source connected** to your video see page 18
- ◆ **To cancel OTR** press the  button (stop) more than 5 seconds.
- ◆ Clock / Counter / Remaining time - page 12.

MORE functions

- ◆ For timer recordings, clock, date, and stations must be set correctly.
- ◆ Load a cassette with its safety tab in place (see page 13) and with sufficient free space for the recording.

Normal timer recording

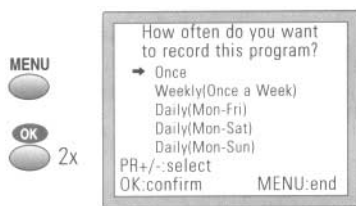
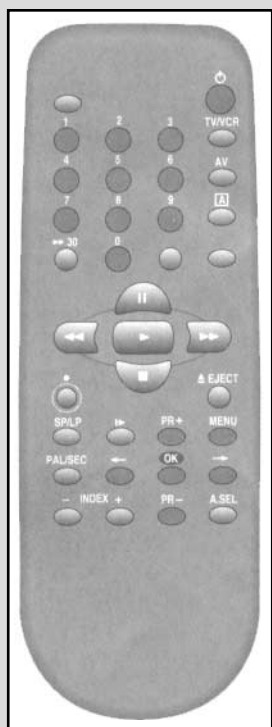

Call the video's "MAIN MENU", choose "Timer Program".

Decide if you want to record "Once", "Weekly" or "Daily" ... and confirm.

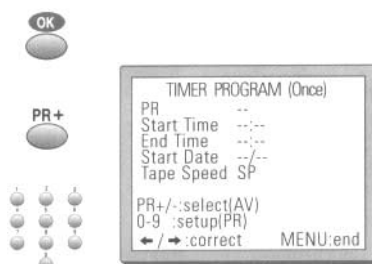

Type in one after the other.

- ◆ The programme location number,
- ◆ the time the broadcast starts,
- ◆ the time the broadcast ends,
- ◆ the day of the broadcast, if it is not today.
- ◆ Select LP if you wish to make a very long recording.



If you wish to make changes: Move to the position you want to change using the ←/→ buttons. Change the setting using the PR+/- or number buttons. If all settings are ok, press ← or → till you see "OK : confirm" in the bottom line.

Confirm.



Switch your video off.



- ◆ Wait a few seconds after typing a **one-digit-number**
- ◆ If you have made a **mistake**, move to the position you want to change using the ←/→ buttons and change the setting
- ◆ If programme timings **overlap**, the machine will give a warning message. If you don't adjust the times, the machine will record the first programme completely then continue with the second one
- ◆ If there is no sufficient free space for the recording on the cassette the video switches **automatically to "LP"** for double recording capacity
- ◆ The recorder will **eject** cassettes which have the safety tab removed (page 13).

M O R E f u n c t i o n s

Timer Review - changing and erasing

MENU

OK



Call the video's "MAIN MENU",
choose "Timer Program"

Select the programming to change or erase.

OK

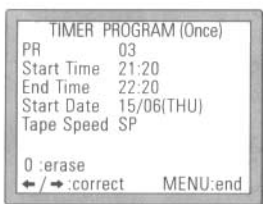
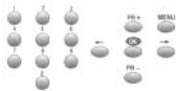

If you want to erase this programming press
button 0, confirm with OK.

If you wish to make changes:

Move to the position you want to change using
the ←/→ buttons.

Change the settings using the PR +/- or number
buttons.

If all setting are ok, press ← or → till you see
"OK: confirm" in the bottom line.

Confirm changes with OK. Exit the menus.

OK

Setting time and date

MENU

PR- 2x

OK 2x

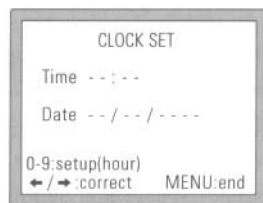

Call the video's "MAIN MENU",
choose "VCR Setup", then "Clock Set"

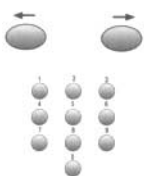

Move to the position you want to change and
type in the new values.

Wait a few seconds after typing a one-digit number

OK MENU

Store with OK button and exit with MENU button.

MORE functions

- ◆ The counter counts in real time from the point you load the cassette This does not have to be its beginning! The counter does not count unrecorded parts of the tape
- ◆ If you rewind beyond the zero position, the counter counts in negative values (e.g.- 0:01:15)

Clock / counter display



- 1x: Time and datecurrent status → Time and date
- 2x: Counter + current status → counter
- 3x: disappear

If didn't wind tape (PLAY, FF, REW,...) it doesn't appear the tape remain time.

Remaining time and cassette length

Call the video's "MAIN MENU", choose "Tape Control".

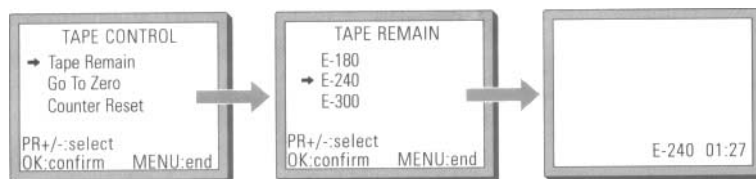

When you want the video to show the time remaining from the current video tape position (to find out if there is sufficient space for a recording, for example).

To ensure the remaining time shown is accurate, select the length of cassette currently loaded by selecting this function until you reach the correct length.

Remaining time display is only possible when the cassette is loaded

Accessing counter zero position

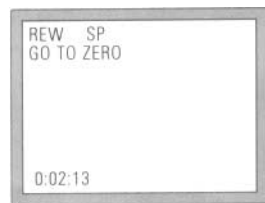

The video will wind to the position 0:00:00 and stop.

Resetting the counter to zero



Reset the counter

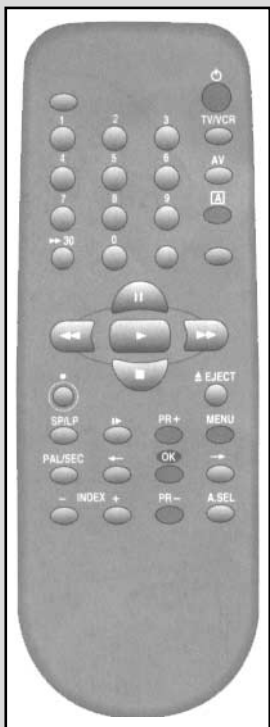

M O R E f u n c t i o n s

Menu languages

MENU



PR -



2x

OK



PR -



OK



Call the video's "MAIN MENU", choose "VCR Setup", then "Language Set"

Select your language
Confirm.

Child Lock



Press the button for about 5 seconds.

Your video can't be operated now, only timer recordings will be performed. Keep your remote control in a safe place.

To release child lock, press the button again for 5 seconds.

Cassettes



Use only good quality tape cassettes with the VHS logo.

- ◆ Keep cassettes away from excessive moisture or dust, magnetic and electrical fields (loudspeakers and computer monitors, for example).
- ◆ Always wind the tape to the beginning when you have finished. Store with the full spool at the bottom and with the cassette in its cover.

You can protect your precious recordings from being wiped by breaking out the safety tab on the side of the cassette (some cassettes have a slide).

Should you wish to re-use the tape after removing the tab, cover the hole with adhesive tape.

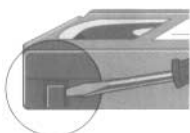

and...

Dimmer

Your video recorder dims its display when switched to stand-by mode.

Auto power off

Your video recorder switches to stand-by when no tape is played and no station is received for more than 5 minutes.

Tuning in NEW STATIONS

- ◆ The TV and video recorder are switched on.
- ◆ To see the picture from your video, press the station button on the TV reserved for video input or the AV (Audio / Video) button.
- ◆ "AV" should not be selected with the AV button on the video.

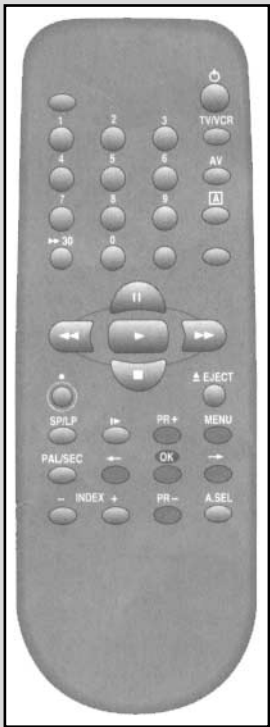

Tuning



Call the video's "MAIN MENU", choose "PR Preset".

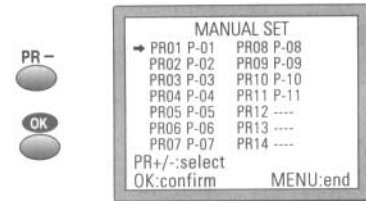

Select "Manual Set"

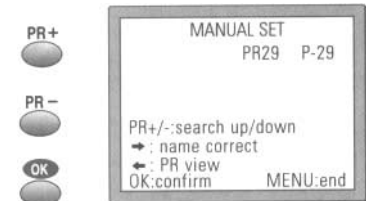

Choose any unused location number "----" or "P-xx" ...
It's simplest to use the same location number on both the TV and video.

...and confirm.

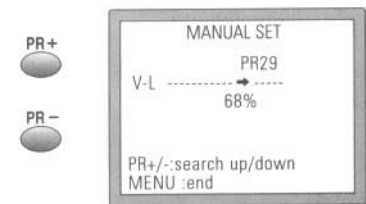

Tune in the station you want.

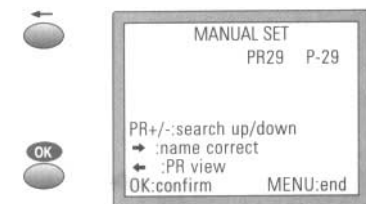

Press ← button to see the picture.
If it isn't the station you want, or the picture is disturbed, carry on tuning.
Once you see the station you want, store it.



Tune in further stations (from step 3 onwards) or exit tuning mode.

Tuning in NEW STATIONS

Station names

If your video is showing no station name or is showing a station name incorrectly, you can correct this. Select "→ : name correct" on the "MANUAL SET" menu.



2x

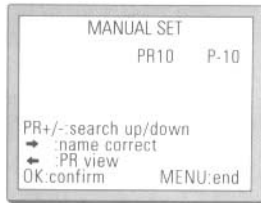

Call this menu (just see the left page), if it isn't displayed.

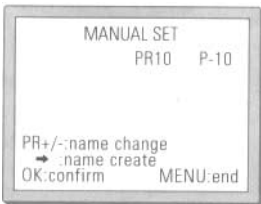

Select "name correct"
Either select the name from the stored list ..

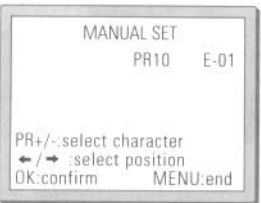

... or you select "→ :name create" and enter a 4-digit name.
Change the letters with the PR +/- buttons, move to the next letter with the ←/→ buttons.



Store and exit.



- ◆ The video's automatic tuning system usually produces the best results. In poor reception areas, fine tuning may improve reception. Choose the station and tune using the ←/→ buttons. Store, typing in the location number again.
- ◆ Should you wish to tune in all the channels available in your region, please refer to page 5.
- ◆ Should you wish to sort or clear stations, please refer to page 16.

Tuning in NEW STATIONS

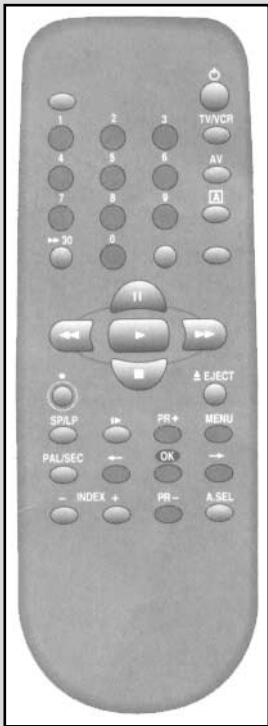

Sorting programme locations

- MENU
- PR -
- OK
- PR +
- OK
- PR +
- PR -
- OK
- PR +
- PR -
- OK
- PR -
- OK
- MENU

If the location numbers used for programmes stored in your TV and video are different, you can change them on the video. To do this, move the stations to the right numbers, until they are arranged the way you want.

Call the video's "MAIN MENU", choose "PR Preset" then "PR Align".



Select the programme to swap. Confirm.

Move the station to the desired location number Confirm

Clearing programme locations

- MENU
- PR -
- OK
- PR + 2x
- OK
- PR +
- PR -
- ←
- OK 2x
- MENU

Call the video's "MAIN MENU", choose "PR Preset" then "PR Erase".

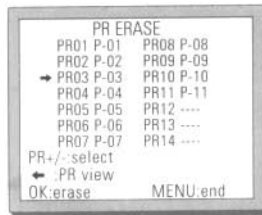

Select the station (location number) you want to clear.

Review the picture.

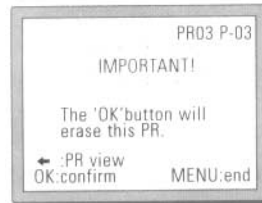

Clear.

CONNECTIONS and copying

- ◆ If you are using a RCA cable, select the AV input on the TV to see the picture from the video
- ◆ If you are not using a RCA cable, select the button number on the TV reserved for video input to see the picture from the video

To the TV via antenna cable (if you are not using a RCA cable)

If you are not using a RCA cable, your video can transmit pictures and sound to the TV via the coax aerial cable. Just tune the TV to the video's output channel (factory set to UHF CH26) Tune the TV carefully to ensure the best pictures and sound.

Once you have carried out the steps in "Connecting up the video recorder" (page 4), switch on your TV.

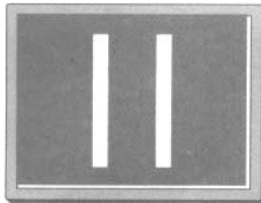

Press the OK button of the video's remote control longer than 5 seconds to call the video's test picture.

Tune the TV to the test picture using the channel pre-set functions of your TV as described in its manual.

When you have found the test picture, store it under the button number on your TV for video input.

Press the OK button of the video's remote control again longer than 5 seconds to release the test picture.

MENU



PR -



2x

OK



PR -



2x

OK



OK



MENU



If the **quality of the test picture** transmitted to the TV is poor due to interference caused by a station transmitting on channel 26, you can tune the video to a different transmitting channel Find a free channel between 21 and 69 on your TV

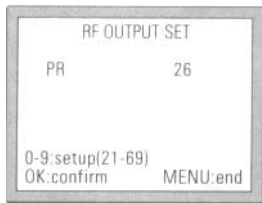

Call the video's "MAIN MENU" choose "VCR Setup" then "RF Output Set".

Type in the free channel.

Store and exit



- ◆ If the quality of the test picture transmitted to the TV is poor, fine-tuning on the TV may help (refer to the TV manual)

CONNECTIONS and copying

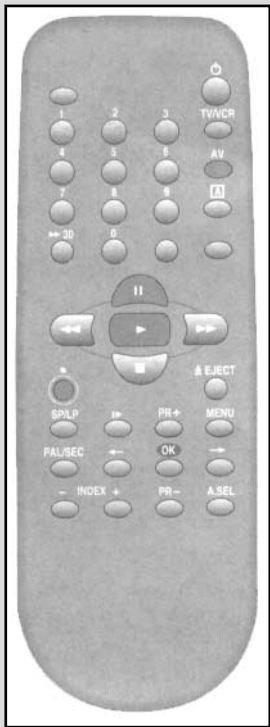

- ◆ Switch off all components when connecting or disconnecting cables

Copying

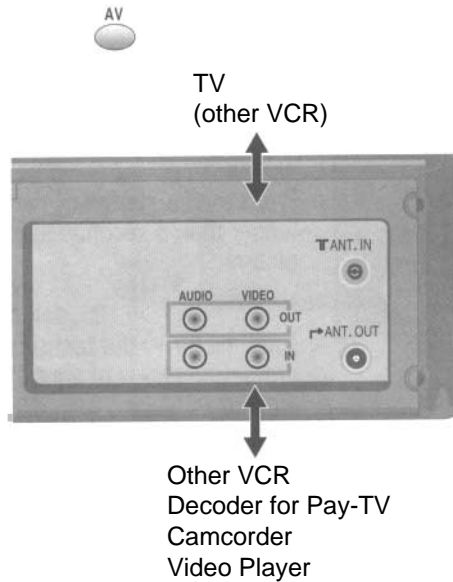

To copy to your video from another video machine, connect the two machines with a cable between their RCA sockets and select as programme "AV" using the AV button.

Set the other video machine to playback and your machine to record.

To copy to another video machine from your video, connect the two machines by means of their RCA sockets. On the other video, select its AV input and set the machine to record.

Switch your video to play back at the position you want copying to start.

Assembling

Should you wish to assemble your own film, from camcorder footage for example, use the assembly technique for smooth edit points:



- ◆ Move the tape to the position at which the new scene is to be added using the play functions (pages 6/7).



- ◆ Wind back slightly before the edit point and put the machine into pause using the || button (do not press STOP!).



- ◆ Now go directly into record.

For the best results, the source cassette from which you are recording should already be playing back when you start recording.

BRIEF INSTRUCTION

f o r e x p e r i e n c e d u s e r s

Playing back

- ◆ Your TV and your video recorder are switched on
- ◆ To see the picture from your video, press the station button on the TV reserved for video input or the AV (Audio/Video) button.



Start playback



Stop playback



Fast forward or rewind the cassette from stop



Still picture from playback. Each press of the button advances the picture one frame. PLAY switches back to normal playback.



Starting from playback you can control search speed in 2 steps either forwards (▶▶) or backwards (◀◀) Press repeatedly.

PLAY switches back to normal playback.



Starting from playback you can control slow motion speed in 6 steps (1/15, 1/10, 1/5, 1/30, 1/25, 1/20, 1/15,) Press repeatedly.

PLAY switches back to normal playback.



Select INDEX + or INDEX - to search forwards or backwards. The video will now wind to the beginning of the first recording, play it for about 6 seconds then wind on to the next one. When you see the recording you want, press play.

Simple recording

- ◆ The TV stations on the video have been tuned in (Page 5)
- ◆ The video is switched on.
- ◆ You can either watch the picture from the video on the TV by pressing the station button reserved for video input or the AV button, watch another TV station or switch off the TV altogether.

Load a cassette with its safety tab in place (see page 13).



Choose the station whose programme you want to record.



If the programme you wish to record is very long, double the possible recording time with "LP" (Long Play).



Up to eight hours with an E-240 cassette.



Start your recording.



If you wish to interrupt recording briefly - then continue.



Stop your recording

One touch recording - OTR



Choose the station you want and press the button once for every 30 minutes of programme you wish to record. Up to ten hours are possible.

BRIEF INSTRUCTION

f o r e x p e r i e n c e d u s e r s

Normal timer

- ◆ For timer recordings, clock, date, and stations must be set correctly.
- ◆ Load a cassette with safety tab in place (page 13) and with sufficient free space for the recording.



Call the video's "MAIN MENU", Confirm, choose "Timer Program".

Decide if you want to record "Once", "Weekly" or "Daily" ... and confirm.

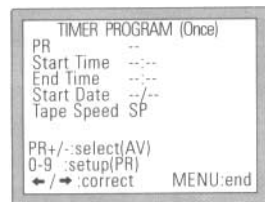

Type in one after the other:

- ◆ the programme location number,
- ◆ the time the broadcast starts,
- ◆ the time the broadcast ends,
- ◆ the day of the broadcast, if it is not today.
- ◆ select LP if you wish to make a very long recording.

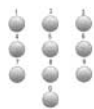

If you wish to make changes:

Move to the position you want to change using the ←/→ button.

Change the setting using the +/- or number button.

If all setting are ok, press ← or → till you see "OK:confirm" in the last line.

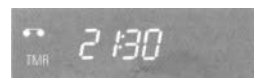

Switch your video off

A P P E N D I X

Before you ask a specialist

Mains supply

the video's display does not light
the video doesn't work

- The mains lead is not connected to the wall socket.
- condensation may have formed when moving the video recorder from a cold to a warm room. Wait until the video (and cassette!) reach room temperature.

Recording

doesn't start
the cassette starts playback
or is ejected

- Is a cassette loaded?
- the safety tab may be missing. Cover the hole with adhesive tape (page 13).

Playback

no picture

- Is the TV tuned to the video (page 5)?
- Is there a recording on the video tape?

poor picture quality

- Use PR. +/- buttons to adjust tracking if horizontal stripes appear.
- Is the cassette of poor quality or worn out? Test with another cassette.
- If you are not using a RCA cable, have you tuned the location for video input on the TV properly? pages 5/17.
- Try a different cassette. The video head drum may need cleaning - ask your dealer.

poor still picture

- Press || (pause) several times. Adjust with the PR +/- buttons until you get the best picture.

Remote control doesn't work

- are the batteries run down?
- is the distance between remote control and video more than 1 meters?
- is there an object blocking the direct line between remote control and video?

General

a cassette won't load

- is there a cassette already loaded? If so, the video's display will indicate it.

the cassette won't rewind, fast forward,
play or record mode
timer is recording incorrectly

- the cassette is already fully wound back or to the end.
- is the clock set correctly (page 11)?

a loud noise when left in Stop mode

- if no play or record function is used for about five minutes when left in Stop mode, the video switches its motor off to conserve the mechanism.

"ERR" shows in the display

- Your video has detected abnormal conditions. Release this mode with any button, your video then safely switches to stand-by.

A P P E N D I X

Index

Aerial	4	Protected cassette	13
Assembling recordings	18	RCA	17
Cassette length	12	Remaining time	12
Channel	5/14-17	RF out	5/17
Child lock	13	SP (Standard Play).....	8-10
CM Skip	7	Stand-by	Precautions
Condensation	Precautions	Station	5/14-17
Counter	12	Still frame adjustment	6
Fine Tuning	15	Test picture	17
Location number	4/14-17	Tracking	6
LP (Long Play)	8-10		
Mains	4/22		
Menu	3		
OTR	9		

Technical data

Dimensions

W x H x D	360 x 90 x 288 mm
Weight	3.85 kg

Power supply

Voltage	AC 240 V- 50 Hz
Power consumption	15 Watt

System

Video	PAL B/G
Channel range	VHF 2 - 12, UHF 21 - 69, CATV S1 -S41, x, y, z (Hyperband)
Channel locations	99 + AUX
RF Out	UHF CH 21 - 69 (26)

Video

System	VHS
Speeds	SP / LP

General

Temperature range	5 - 35 ⁰ C
Humidity range	< 80 %
Timer	8 events, 1 month

Subject to technical alterations without notice.

Quick Start Guide

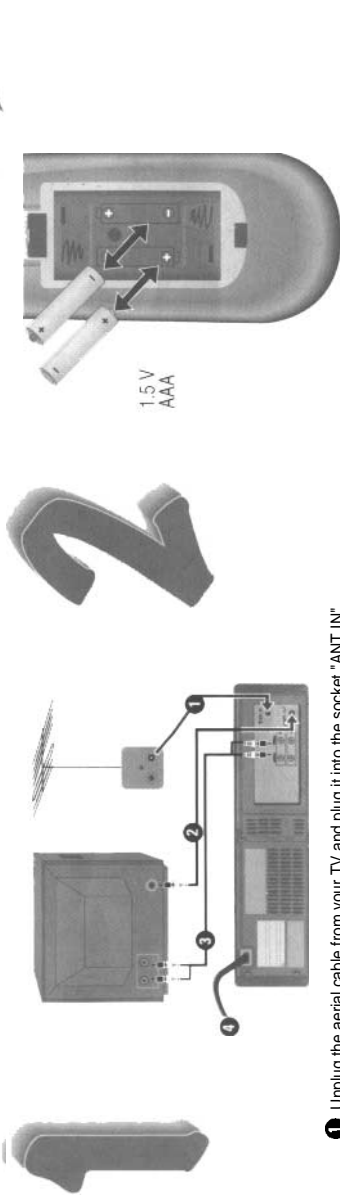

- 1 Unplug the aerial cable from your TV and plug it into the socket "ANT.IN" of the video.
- 2 Plug the short coaxial cable provided into the "ANT.OUT" socket of the video and the aerial socket of the TV.
- 3 Plug a RCA cable into the "RCA" socket of the video and the AV socket on the TV if available.
- 4 Now plug in the main lead. The display of the video should now light.

Fit the batteries as shown by the pictures in the bay.
Press any button to turn on the power.

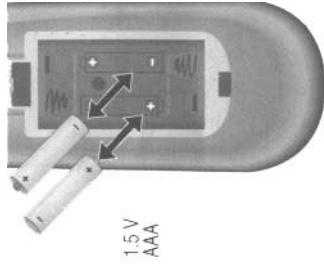

1.5 V
AAA

3



You should see this picture the first time you switch on the TV and video
Choose your language.



OK for "Auto Search!".

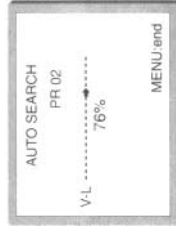

"AUTO SEARCH" tunes in all the stations you can receive in your country and ...



...sorts them in an order common for your country. Then type in the current time and date.



Exit the basic installation function and enjoy your Video cassette recorder.

Free Manuals Download Website

<http://myh66.com>

<http://usermanuals.us>

<http://www.somanuals.com>

<http://www.4manuals.cc>

<http://www.manual-lib.com>

<http://www.404manual.com>

<http://www.luxmanual.com>

<http://aubethermostatmanual.com>

Golf course search by state

<http://golfingnear.com>

Email search by domain

<http://emailbydomain.com>

Auto manuals search

<http://auto.somanuals.com>

TV manuals search

<http://tv.somanuals.com>