

Panasonic®

Operating Instructions Air Conditioner

CS-E24FKR
CS-E28FKR

CU-E24FKR
CU-E28FKR

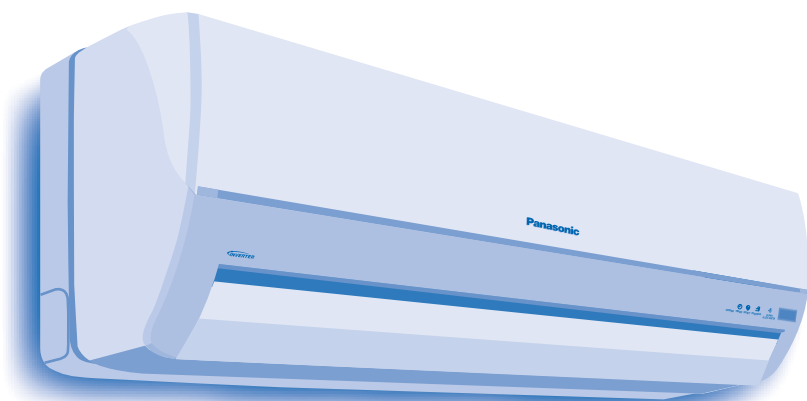

ENGLISH

Before operating the unit, read these operating instructions thoroughly and keep them for future reference.

Manufactured by:

Panasonic HA Air-Conditioning (M) Sdn. Bhd.

Lot 2, Persiaran Tengku Ampuan, Section 21, Shah Alam Industrial Site,
40300 Shah Alam, Selangor, Malaysia.

© 2006 Panasonic HA Air-Conditioning (M) Sdn Bhd
(11969-T). All rights reserved. Unauthorized copying
and distribution is a violation of law.

Thank you for purchasing Panasonic Air Conditioner

SAFETY PRECAUTIONS

■ Definition

To prevent personal injury, injury to others, or property damage, please observe the following.

Incorrect operation due to failure to follow instructions may cause harm or damage, the seriousness of which is classified as below:



Warning

This sign warns of death or serious injury.



Caution

This sign warns of injury or damage to property.

The instructions to be followed are classified by the following symbols:



This symbol denotes an action that is PROHIBITED.



These symbols denote actions that are COMPULSORY.



Warning

During Installation

- Do not install, remove and reinstall the unit by yourself; improper installation will cause leakage, electric shock or fire. Please consult an authorized dealer or specialist for the installation work.
- This equipment must be earthed and installed with ELCB. It may cause electrical shock or fire in case of malfunction

During Operation



- Do not share the same power outlet with other equipment.
- Do not modify power cords.
- Do not use extension cords.
- Do not operate with wet hands.
- Do not insert your fingers or other objects into the indoor or outdoor unit.
- Do not attempt to repair the unit by yourself.
- Do not use rechargeable (Ni-Cd) batteries.
- Do not allow infants and small children to play with the remote control to prevent them from accidentally swallowing the batteries.



- Use the specified supply cord.
- If the supply cord is damaged, it must be replaced by the manufacturer, its service agent or similarly qualified persons in order to avoid a hazard.
- Remove the batteries if the unit is not going to be used for a long period of time.
- New batteries of the same type must be inserted following the polarity stated to prevent malfunction of the remote control.



- In case of emergency or abnormal conditions (burning, unusual odour, etc), turn off the power supply.



Caution

During Installation



- Ensure that the drainage pipe is connected properly. Otherwise, leakage may occur.



- Do not install the unit in a potentially explosive atmosphere.

During Operation



- Do not wash the unit with water, benzene, thinner or scouring powder.
- Do not use for other purposes such as preservation of food.
- Do not use any combustible equipment in front of the airflow outlet.
- Do not sit or place anything on the indoor or outdoor unit.
- Do not expose directly to cold air for a long period.



- Switch off the power supply before cleaning or servicing.
- Turn off the power supply if the unit is not used for a long period of time.
- This air conditioner is equipped with a built-in surge protective device. However, in order to further protect your air conditioner from being damaged by abnormally strong lightning activity, you may want to disconnect it from the power supply. Do not touch the air conditioner during lightning, it may cause electric shock.



- Aerate the room regularly.
- After long periods of use, make sure the installation rack is not damaged.

Table of Content

SAFETY PRECAUTIONS.....	2
REGULATORY INFORMATION	3
PRODUCT OVERVIEW	4
AUTO, HEAT, COOL, DRY	5
FAN SPEED, AIR SWING	6
POWERFUL, QUIET	7
TIMER	8
CARE & CLEANING.....	9

REGULATORY INFORMATION

The appliance is not intended for use by young children or the infirm person without supervision. Young children should be supervised to ensure that they do not play with the appliance.

Environmental Requirements



Battery Disposal

The batteries must be recycled or disposed of properly.

End-of-Life Disposal



“Instructions for end-user” for air conditioners:

Information on Disposal in other countries outside the European Union

This symbol is only valid in the European Union. If you wish to discard this product, please contact your installer, dealer or local authority and ask for the correct method of disposal.

■ Operation Condition

Use this air conditioner under the following temperature range.

Temperature (°C)		Indoor	
		*DBT	*WBT
COOLING	Maximum	32	23
	Minimum	16	11
HEATING	Maximum	30	–
	Minimum	16	–

Temperature (°C)		Outdoor	
		*DBT	*WBT
COOLING	Maximum	43	26
	Minimum	16	11
HEATING	Maximum	24	18
	Minimum	-5	-6

***DBT: Dry bulb temperature**

***WBT: Wet bulb temperature**

Note:

The illustrations in this manual are for explanation purposes only and may differ from the actual unit. It is subjected to change without notice for future improvement.

PRODUCT OVERVIEW

About

Remote Control Preparation

1. Pull out the cover.
2. Insert AAA or R03 batteries.
3. Close the cover.
4. Press CLOCK.

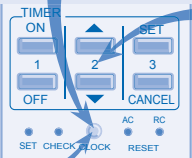

5. Press to set time.

6. Press again.
- Timer operation will be based on current time set.
 - The batteries can be used for approximately 1 year.

Remote Control Signal

- Make sure it is not obstructed.
- Maximum distances : 10m.
- Certain fluorescent lights may interfere with signal transmission. Please consult your nearest dealer.

Auto OFF/ON Button

Action	Mode
Press once.	Automatic
Press and hold until you hear one beep, then release.	Cooling
Press until you hear one beep then release. Press again until you hear two beeps then release.	Heating

- To turn off, press the AUTO OFF/ON button again.

Indoor Unit

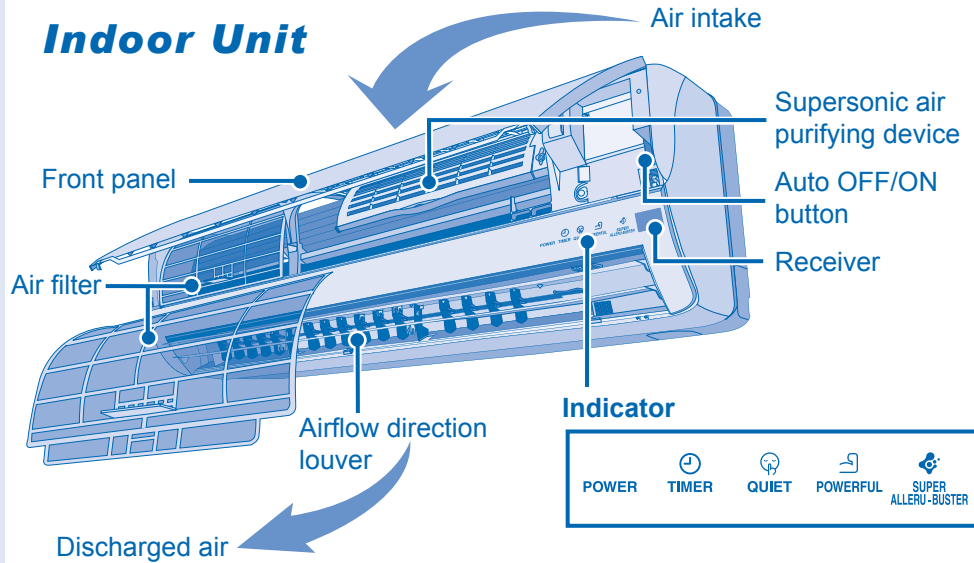

Outdoor Unit

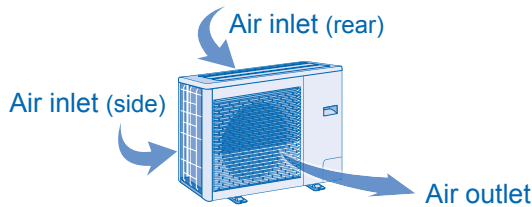

Remote Control

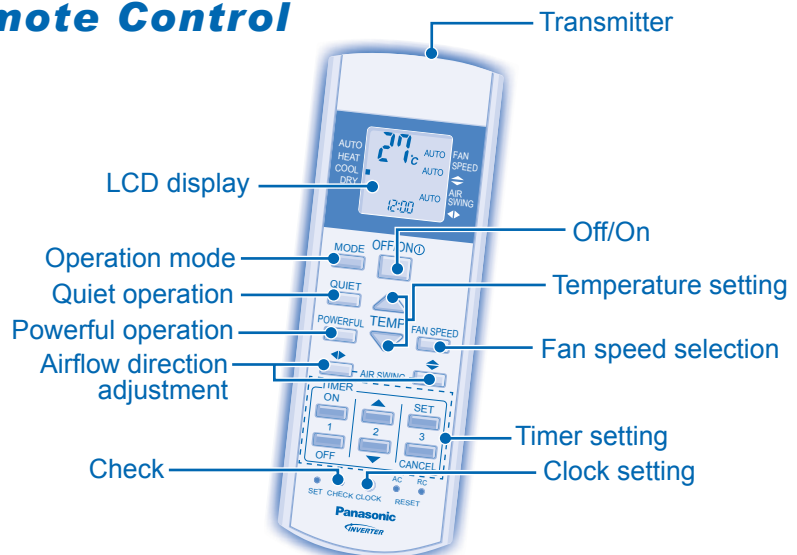

- * For normal operation, the AC and SET reset buttons are not in use.
- * Press RC reset to restore the remote control's default setting.

Troubleshooting

- In the event of an error, the unit will stop and the timer indicator will blink.

1. Press for 5 seconds.

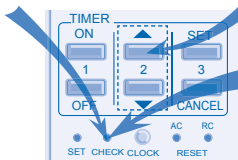

2. Press until you hear beep sound, then jot down the error code.

3. Press for 5 seconds to quit checking.

4. Turn the unit off and reveal the error code to your nearest dealer.

Notes:

- The unit may be operable (with 4 beeps) on a limited basis, depending on the error.

AUTO, HEAT, COOL, DRY

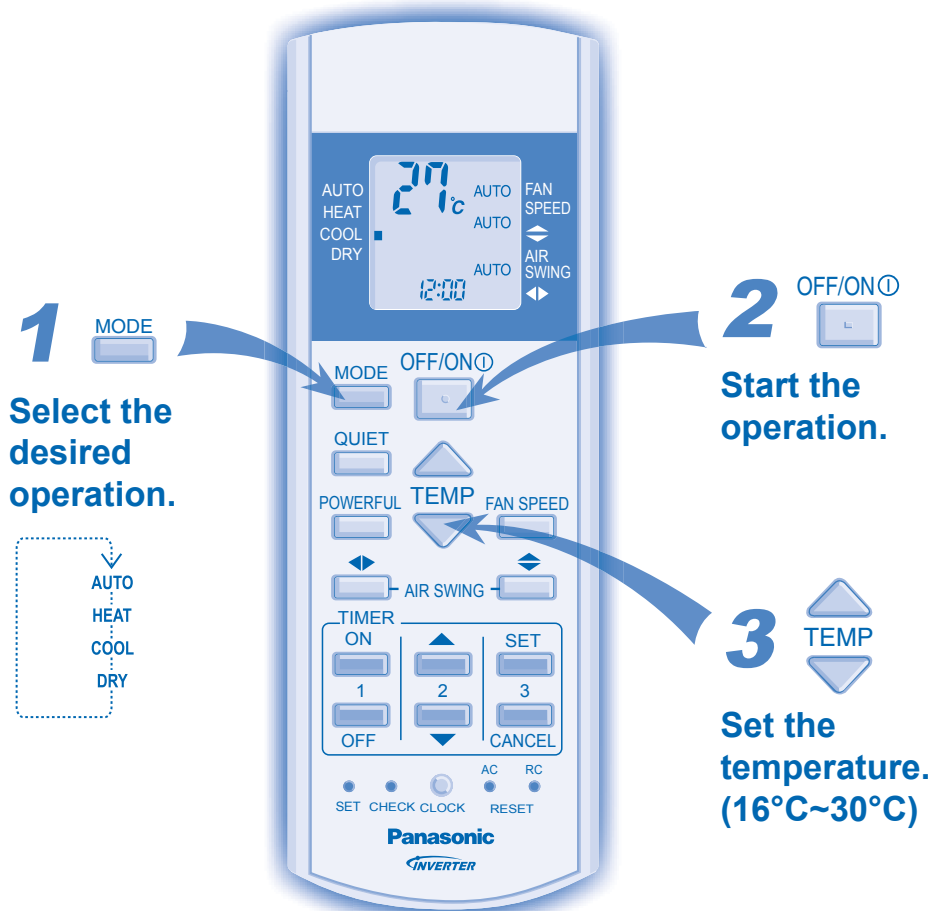

1 Select the desired operation.

2 Start the operation.

3 Set the temperature. (16°C~30°C)

■ Operation Details

AUTO - Automatic Operation

- Unit selects the operation mode according to temperature setting, outdoor and room temperature.
- The power indicator blinks during operation.
- Operation mode is reselected every 30 minutes.

HEAT - Heating Operation

- In heating mode, it takes a while for the unit to warm up. The power indicator blinks during this operation.

COOL - Cooling Operation

- Enjoy cool air at your desired temperature.

DRY - Soft Dry Operation

- Keeps your environment dehumidified by running a very gentle cooling operation.
- During soft dry operation, the indoor fan operates at low fan speed.

■ Hint

- A temperature setting 1°C higher in cooling operation or 2°C lower in heating operation than the desired temperature equates to a 10% power saving.

- Supersonic air purifying device operates automatically once the unit is switched on.
- **POWERFUL** and **QUIET** operations are available in all modes.
- Press **OFF/ON** again to stop the operation.

Troubleshooting

- | | |
|--|--|
| <ul style="list-style-type: none"> • Mist emerges from indoor unit. • Heating/Cooling operation does not work. | <ul style="list-style-type: none"> ▶ Condensation effect due to cooling process. ▶ Ensure temperature is set correctly. ▶ Make sure windows and doors are closed. ▶ Make sure filters are cleaned and replaced. ▶ Make sure inlet and outlet vents are cleared. |
| <ul style="list-style-type: none"> • Water flowing sound during operations. | <ul style="list-style-type: none"> ▶ Cause by refrigerant flow inside the unit. |
| <ul style="list-style-type: none"> • The power indicator blinks during the operation and the indoor fan is stopped. | <ul style="list-style-type: none"> ▶ The unit is in defrost mode, and the melted frost is drained from the outdoor unit. |

FAN SPEED, AIR SWING

Operations Details

FAN SPEED

- There are 5 fan speeds, as well as automatic*.
- * For automatic fan speed, the speed of the indoor fan is automatically adjusted according to the operation.

AIR SWING

- Keeps the room ventilated.
- There are 5 options for vertical/horizontal airflow direction.
- Do not adjust the vertical and horizontal louvers by hand.



- If automatic vertical airflow direction has been set, the louvers swing up and down automatically.
- For HEATING operation, the air blows horizontally for a while, then starts to blow downwards.



- If automatic horizontal airflow direction has been set, the louvers swing left and right automatically.
- For HEATING operation, the airflow louvers start to swing left/right after the temperature rises.

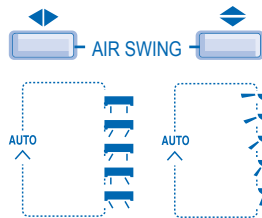

Adjust the airflow direction louver.

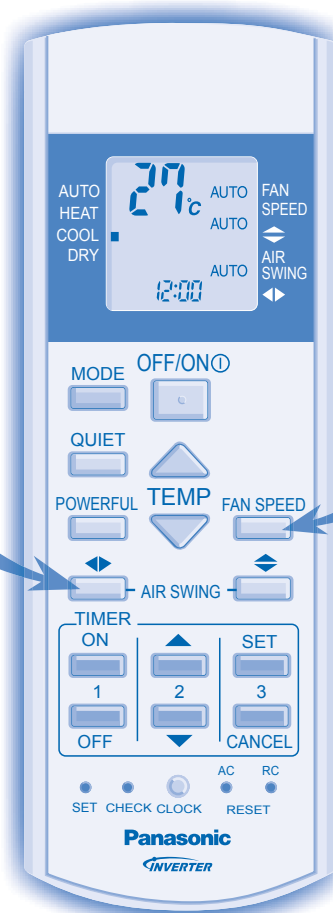

FAN SPEED

Select fan speed.

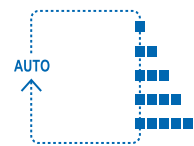

Troubleshooting



- | | |
|---|--|
| • The room has a peculiar odour. | ▶ This may be a damp smell emitted by the wall, carpet, furniture or clothing. |
| • Indoor fan stops occasionally during automatic fan speed setting. | ▶ This helps to remove the surrounding odours. |
| • Indoor fan stops occasionally during heating operation. | ▶ To avoid unintended cooling effect. |

POWERFUL, QUIET



Enables quiet operation.



Enables powerful operation.

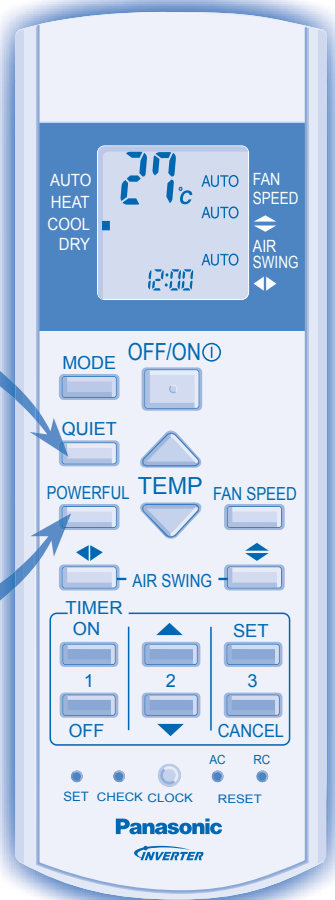

■ Operation Details



- To reach the desired set temperature quickly.



- To provide a quiet surrounding

■ Hint

- To reduce power consumption during cooling operation, close the curtains to prevent the sunlight and heat from coming in.

- and operations could not be activated at the same time.
- and operations could be cancelled by pressing the respective button again.



Troubleshooting



- Noisy during operation. ▶ The unit may have been installed at an incline, or the front panel is not closed properly.
- Operation is delayed a few minutes after restart. ▶ The delay is a protection to the unit's compressor.
- Outdoor unit emits water/steam. ▶ Condensation or evaporation occurs on pipes.

TIMER

■ Operation Details

- The timer allows you to turn the air conditioner on or off automatically.
- The unit may start in preliminary operation before the actual set time when ON timer has been set.
- The set timer repeats daily once set.
- If there is a power failure, you can restore the previous setting (once power is resumed) by pressing the  button.
- If the timer is cancelled, press  to restore the previous setting.

■ Hints

- Press and hold the  for approximately 5 seconds to set either 12-hour (am/pm) or 24-hour time indication.
- To dim the indicator display:

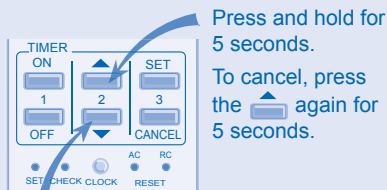

- To switch the temperature setting to °C or °F, press and hold  for approximately 10 seconds.

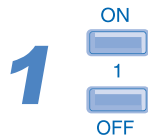

1 Select ON or OFF timer.

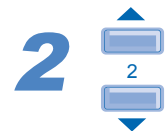

2 Set the desired time.





3 Confirm the setting.

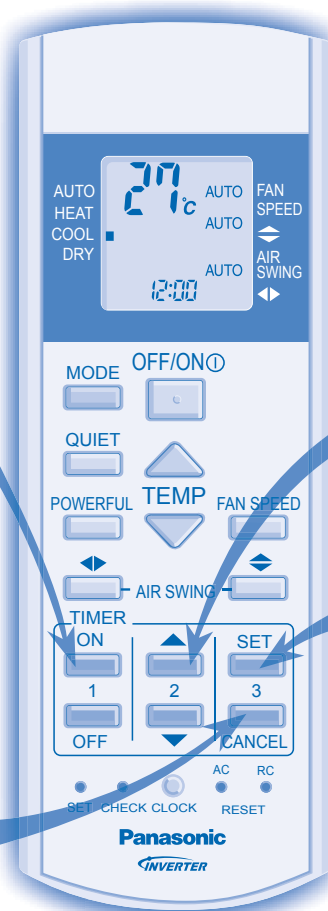

Cancel the selected timer.



- The timer is valid only when the clock is set correctly.
- You can set your preferred time for ON and OFF timers. The unit will turn ON or OFF automatically.
- To cancel ON or OFF timer, press  or , then press .

Troubleshooting

- Timer indicator always on. ▶ The timer setting repeats daily once set.
- Remote control does not work. ▶ The batteries are inserted incorrectly or need replacing.
- The unit does not work. ▶ The circuit breaker is tripped or the timer is set incorrectly.
- Power indicator blinks before the unit is switched on. ▶ This is a preliminary step in preparation for the operation when the ON timer has been set.

CARE & CLEANING



Switch off the power supply before cleaning

FRONT PANEL

Raise and pull to remove.
Wash and dry.

AIR FILTER

Vacuum, wash and dry.

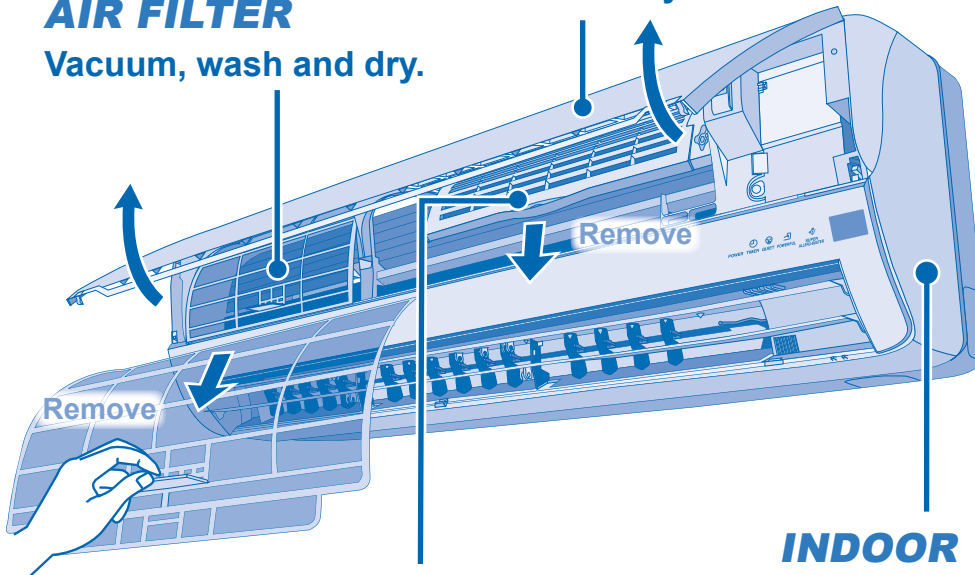

SUPERSONIC AIR PURIFYING DEVICE

INDOOR UNIT

Wipe gently.

Washing Instructions

- Do not use benzene, thinner or scouring powder.
- Use only soaps (\approx pH7) or neutral household detergent.
- Do not use water hotter than 40°C.

INDOOR UNIT

- Wipe the unit gently with a soft, dry cloth.

AIR FILTER

- Air filters cleaning is needed every two weeks.
- Replace any damaged filter.
Part no: CWD001137
CWD001138

SUPER ALLERU-BUSTER AND DEODORIZING FILTERS

- It is recommended to vacuum the filters every 6 months.
- For best performance, place the deodorizing filter under direct sunlight for at least six hours every six months.
- Replace the filter every 3 years or replace any damaged filters.
Part no: CZ-SAD13P

Hints

- Clean the filter regularly for best performance and to reduce power consumption.
- Please consult your nearest dealer for seasonal inspection.

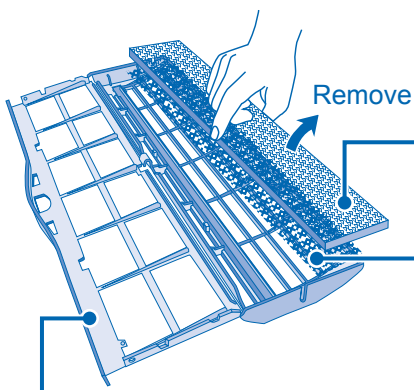

Vacuum the super alleru-buster filter.

Vacuum the deodorizing filter and place under direct sunlight.

Vacuum, wash and dry the frame.

For extended non-use

- Activate heating for 2~3 hours to thoroughly dry the unit.
- Turn off the power supply.
- Remove the remote control batteries.

SEASONAL INSPECTION AFTER EXTENDED NON-USE:

- Checking of remote control batteries.
- No obstruction at inlet and outlet vents.
- After 15 minutes of operation, it is normal to have the following temperature difference between inlet and outlet vents:
Cooling: $\geq 8^{\circ}\text{C}$
Heating: $\geq 14^{\circ}\text{C}$

NON SERVICEABLE CRITERIAS

TURN OFF POWER SUPPLY and CALL Authorized Distributor under the following conditions:

- Abnormal noise during operation
- Water/foreign particles have entered the Remote Control
- Water leak from Indoor unit
- Circuit breaker switches off frequently
- Power cord becomes unnaturally warm
- Switches or buttons are not functioning properly



Free Manuals Download Website

<http://myh66.com>

<http://usermanuals.us>

<http://www.somanuals.com>

<http://www.4manuals.cc>

<http://www.manual-lib.com>

<http://www.404manual.com>

<http://www.luxmanual.com>

<http://aubethermostatmanual.com>

Golf course search by state

<http://golfingnear.com>

Email search by domain

<http://emailbydomain.com>

Auto manuals search

<http://auto.somanuals.com>

TV manuals search

<http://tv.somanuals.com>