

TECHNICAL & SERVICE MANUAL

OUTDOOR UNIT : CU-3KS19NBU

CU-4KS24NBU

CU-4KS31NBU

DC INVERTER MULTI-SYSTEM AIR CONDITIONER

Capacity at 230V	Outdoor Model No.	Product Code No.
19,700 BTU/h	CU-3KS19NBU	1 852 361 24
25,400 BTU/h	CU-4KS24NBU	1 852 361 25
30,600 BTU/h	CU-4KS31NBU	1 852 361 26

CU-3KS19NBU

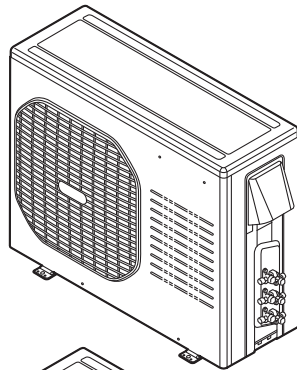

CU-4KS24NBU

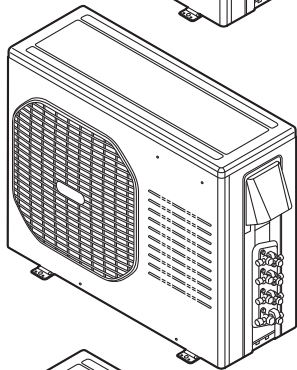

CU-4KS31NBU

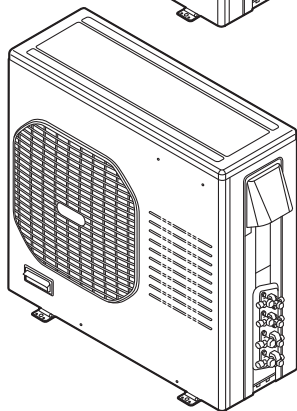

< Applicable Indoor Units >

- Wall mounted type
 - CS-MKS7NКУ
 - CS-MKS9NКУ
 - CS-MKS12NКУ
 - CS-MKS18NКУ
 - CS-MKS24NКУ
- Semi-concealed type
 - CS-MKS9NB4U & CZ-18BT1U
 - CS-MKS12NB4U & CZ-18BT1U
 - CS-KS18NB4UW & CZ-18BT1U

IMPORTANT









These air conditioners employ new refrigerant R410A.















Pay special attention when servicing the unit.









R410A

REFERENCE NO. SM700877

SAFETY PRECAUTIONS

- Before doing repair work, please read the " SAFETY PRECAUTIONS" carefully and fully understand them.
- The precautionary items here are divided into " Warning" and " Caution" items.
Items in particular which may cause death or serious injury to the service personnel if the work is not performed correctly, are included in the " Warning" table.
However, even precautionary items identified as " Caution" also have the potential for serious consequences if not performed correctly.
Important safety precautions are described for all items in both categories. Be sure to carefully follow all of them.
- Symbol Indication
 -  : This symbol indicates items to which we need to pay attention.
In this triangle, a definite precautionary item is described.
 -  : This symbol indicates the item to be prohibited.
In or close to this circle, a prohibited item is described.
 -  : This symbol indicates the items requiring special attention or instruction.
In or close to this circle, a prohibited item is described.
- After doing repair work, perform a test run to confirm that there are no abnormalities.
At the same time, explain the precautions in use to the user.

 Warning	
Before performing an overhaul, disconnect the power plug or power cable from the unit. Performing the work with the power supplied to the unit, may cause an electric shock.	
When repair work or circuit inspection that requires power supply for the air conditioner, is to be performed, do not touch the charging section. Doing so may cause an electric shock.	 Prohibit
For the step-up capacitor attached to the electric section, perform the repair work after sufficiently discharging it. Insufficient capacitor discharge may cause an electric shock.	
Do not perform repair work on the electric sections with wet hands. Doing so may cause an electric shock.	 Prohibit
Do not start or stop the air conditioner by means of connecting or disconnecting the power plug. Doing so may cause an electric shock or fire.	 Prohibit
When conducting repair work only use components included in the parts list for the corresponding unit and perform the work with the appropriate tools. Incorrect or poor repair work may cause an electric shock or fire.	
Never modify the unit. Doing so may cause an electric shock or fire.	 Prohibit
Perform all electric work according to local applicable regulations related to electrical equipment or interior wiring regulation and make sure to use the exclusive circuit. Insufficient capacity to the electric circuit or defective arrangement results may cause an electric shock or fire.	
Make sure to replace any power cable or lead wire showing any signs of scratch or deterioration. Failure to do so may cause an electric shock, overheating or fire.	
Make sure that there is no dust on or slack in the power plug and insert fully into the socket. Dust or incomplete connections may cause an electric shock or fire.	
Do not damage or process the power cord, as it may cause an electric shock or fire.	 Prohibit
For the wiring between the indoor unit and outdoor unit, securely fix the specified cable onto the terminal plate. Poorly fixed wiring may cause a heat or fire.	
After connecting the wiring between the indoor unit and outdoor unit, attach the terminal cover securely. Incomplete attachment of the terminal cover may cause overheating or fire.	

 Warning	
If refrigerant gas blows off during the work, do not touch the refrigerant gas as it may cause frostbite.	 Prohibit
If refrigerant gas leaks during the work, ventilate the room. If refrigerant gas catches fire, harmful gas may be generated.	
Do not mix any gas other than the specified refrigerant gas in the refrigerating cycle. If air or other contaminants mix with the gas, pressure will become extremely high in the refrigerating cycle, which may cause a unit breakdown."	 Prohibit
When the welded section of the compressor intake or discharge pipe is to be disconnected, perform it in a well-ventilated place after sufficiently recovering the refrigerant gas. Any residue gas may jet out refrigerant or refrigerating machine oil, which may cause an injury.	
When the work is to be performed in a high place (About 2 meters or more), make sure to wear a safety helmet, gloves and safety belt. Insufficient safety gear may cause a serious injury in case of a fall.	
When the unit is to be relocated, confirm that the new installation location has sufficient strength for the weight of the unit. Insufficient strength of the installation location and incomplete installation work may cause an injury due to the unit falling.	
When the remote controller batteries are replaced, dispose of the old batteries out of the reach of children. If a child swallows a battery, make sure that the child gets immediate medical attention.	













 Caution	
Do not wash the air conditioner with water, as this may cause an electric shock or fire.	 Prohibit
For the repair work in places with high humidity or moisture, make sure to ground the unit. Failure to do so may cause an electric shock.	
Confirm that the component attachment position, wiring condition, soldering condition and connector connection are normal. If not, it may cause overheating or fire.	
Confirm that the temperature around the compressor is not too high, and then perform the repair work. Failure to do so may cause a burn.	
Perform welding work in a place with good ventilation. If the work is performed in a poorly ventilated area, it might cause a lack of oxygen.	
If the installation plate or attachment frame has deteriorated due to corrosion, etc., replace it. Failure to do so may cause an injury due to the unit falling.	
When the cleaning is to be performed, make sure to turn off the power and pull out the plug. Touching the fan that is rotating at high speed may result in an injury.	
When the indoor unit is to be removed, do not place it on an incline. Doing so may cause wet furniture because water left inside may trickle down.	 Prohibit
Do not hold the sharp end of the unit or the aluminum fins, as it may cause an injury to your hand or finger.	 Prohibit
After repairs, make sure to measure the insulation resistance and confirm that the value is 1 Mohm or more. Any insulation error may cause an electric shock.	
After repairs, make sure to check the drainage of the indoor unit. Inappropriate drainage may cause wet furniture and floors due to water leakage.	

Table of Contents

	Page
⚠ SAFETY PRECAUTIONS	2
TABLE OF CONTENTS	4
■ APPLICABLE INDOOR UNITS	6
1. OPERATING RANGE	7
2. SPECIFICATIONS	
2-1. Unit Specifications	8
2-2. Major Component Specifications	17
2-3. Other Component Specifications	20
3. DIMENSIONAL DATA	21
4. REFRIGERANT FLOW DIAGRAM	
4-1. Refrigerant Flow Diagram	24
5. PERFORMANCE DATA	
5-1. Temperature Charts	27
5-2. Cooling Capacity	50
5-3. Cooling Capacity (Low Ambient)	56
6. ELECTRICAL DATA	62
6-1. Electric Wiring Diagrams	
7. FUNCTIONS	65
7-1. Explanation of Functions.....	69
7-2. Protective Functions	
8. TROUBLESHOOTING (BEFORE CALLING FOR SERVICE)	71
8-1. Precautions before Performing Inspection or Repair.....	72
8-2. Trouble Diagnosis by Error Monitor Lamps.....	73
8-3. Checking the Outdoor System	74
8-4. Trouble Diagnosis of Each Part	78
8-5. Trouble Diagnosis of Fan Motor	

9. REFRIGERANT R410A:**SPECIAL PRECAUTIONS WHEN SERVICING UNIT**

9-1. Characteristics of New Refrigerant R410A	79
9-2. Checklist before Servicing	80
9-3. Tools Specifically for R410A	81
9-4. Tubing Installation Procedures	81
9-5. In Case of Compressor Malfunction	82
9-6. In Case Refrigerant is Leaking	84
9-7. Charging Additional Refrigerant	85
9-8. Retro-Fitting Existing Systems	85

APPENDIX A INSTALLATION INSTRUCTIONS	A-1
---	-----

■ APPLICABLE INDOOR UNITS

● Wall Mounted Type

Multi-Outdoor Unit \ Indoor Unit		CS-MKS7NKH	CS-MKS9NKH	CS-MKS12NKH	CS-MKS18NKH	CS-MKS24NKH
		3-Room	CU-3KS19NBU	YES	YES	YES
4-Room	CU-4KS24NBU	YES	YES	YES	YES	YES
4-Room	CU-4KS31NBU	YES	YES	YES	YES	YES

● Semi-Concealed Type

Multi-Outdoor Unit \ Indoor Unit		CS-MKS9NB4U & CZ-18BT1U	CS-MKS12NB4U & CZ-18BT1U	CS-KS18NB4UW & CZ-18BT1U
		3-Room	CU-3KS19NBU	YES
4-Room	CU-4KS24NBU	YES	YES	YES
4-Room	CU-4KS31NBU	YES	YES	YES

1. OPERATING RANGE

	Temperature	Indoor Air Intake Temp.	Outdoor Air Intake Temp.
Cooling	Maximum	95 °F DB / 71 °F WB	115 °F DB
	Minimum	67 °F DB / 57 °F WB	14 °F DB

2. SPECIFICATIONS

2-1. Unit Specifications

Outdoor Unit **CU-3KS19NBU**

Indoor Unit **CS-MKS9NKU × 2**

Duct Less Type Rated

< 230V >

Type		3-Room Multi Outdoor Unit		
Number of Connectable Indoor Units		3		
Number of Operatable Indoor Units		3		
Voltage Rating		230V Single-Phase 60Hz		
		Cooling		
Performance	Total Capacity	BTU/h	17,000 (6,800 to 18,800)	
		kW	5.00 (1.90 to 5.50)	
	Sensible Capacity	BTU/h	14,300	
	Latent Capacity	BTU/h	2,700	
	Air Circulation (High)	ft ³ /min (m ³ /h)	1,707 (2,900)	
Electrical Rating	Available Voltage Range	V	187 to 253	
	Running Amperes	A	6.3	
	Power Input	W	1,420	
	Power Factor	%	98	
	EER	BTU/h/W	12.0	
	SEER	BTU/Wh	18.0	
	Compressor Locked Rotor Amperes	A	13.0	
	Fuse or Circuit Breaker Capacity	A	15	
		Outdoor Unit		
Features	Control		Microprocessor	
	Fan Speeds		Auto (Hi, Me, Lo)	
	Compressor		DC Twin Rotary (Inverter)	
	Refrigerant / Amount charged at shipment	lbs (g)	R410A / 6.17 (2,800)	
	Refrigerant Control		Electric Expansion Valve	
	Operation Sound (High) Cool	dB-A	50	
	Refrigerant Tubing Connections		Flare Type	
	Max. allowable tubing length per unit	ft (m)	82 (25)	
	Refrigerant	Narrow tube inch (mm)	1/4 (6.35) × 3	
	Tube Diameter	Wide tube inch (mm)	3/8 (9.52) × 3	
		Outdoor Unit		
Dimensions & Weight	Unit Dimensions		29-1/8 × 35-7/16 × 12-19/32	
	Height × Width × Depth		(740 × 900 × 320)	
	Package Dimensions		34-3/16 × 41-11/32 × 16-21/32	
	Height × Width × Depth		(868 × 1,050 × 423)	
	Weight	Net	lbs (kg)	138.9 (63.0)
		Shipping	lbs (kg)	147.7 (67.0)
Shipping Volume		cu.ft (m ³)	13.41 (0.38)	

DATA SUBJECT TO CHANGE WITHOUT NOTICE.

Remarks:

- The values shown in performance section and electrical rating section above are based on the following unit combination.
For other combination unit, please refer to the "Unit Combination Tables" in this manual.
Indoor Unit : CS-MKS9NKU 2units Outdoor Unit : CU-3KS19NBU 1unit
The combination indoor unit is AHRI 210/240.
- Rating conditions are: Cooling : Indoor air temp. 80 °F DB / 67 °F WB
Outdoor air temp. 95 °F DB / 75 °F WB

Outdoor Unit **CU-3KS19NBU**
 Indoor Unit **CS-MKS9NKU × 3**

< 230V >

Type		3-Room Multi Outdoor Unit			
Number of Connectable Indoor Units		3			
Number of Operatable Indoor Units		3			
Voltage Rating		230V Single-Phase 60Hz			
		Cooling			
Performance	Total Capacity	BTU/h	18,800 (9,800 to 18,800)		
		kW	5.50 (2.90 to 5.50)		
	Sensible Capacity	BTU/h	16,000		
	Latent Capacity	BTU/h	2,800		
	Air Circulation (High)	ft ³ /min (m ³ /h)	1,707 (2,900)		
Electrical Rating	Available Voltage Range		V	187 to 253	
	Running Amperes		A	6.7	
	Power Input		W	1,500	
	Power Factor		%	98	
	EER		BTU/h/W	12.5	
	Compressor Locked Rotor Amperes		A	13.0	
	Fuse or Circuit Breaker Capacity		A	15	
			Outdoor Unit		
Features	Control		Microprocessor		
	Fan Speeds		Auto (Hi, Me, Lo)		
	Compressor		DC Twin Rotary (Inverter)		
	Refrigerant / Amount charged at shipment		lbs (g)	R410A / 6.17 (2,800)	
	Refrigerant Control		Electric Expansion Valve		
	Operation Sound (High) Cool		dB-A	50	
	Refrigerant Tubing Connections		Flare Type		
	Max. allowable tubing length per unit		ft (m)	82 (25)	
	Refrigerant		Narrow tube	inch (mm)	1/4 (6.35) × 3
	Tube Diameter		Wide tube	inch (mm)	3/8 (9.52) × 3
		Outdoor Unit			
Dimensions & Weight	Unit Dimensions		inch	29-1/8 × 35-7/16 × 12-19/32	
	Height × Width × Depth		(mm)	(740 × 900 × 320)	
	Package Dimensions		inch	34-3/16 × 41-11/32 × 16-21/32	
	Height × Width × Depth		(mm)	(868 × 1,050 × 423)	
	Weight		Net	lbs (kg)	138.9 (63.0)
			Shipping	lbs (kg)	147.7 (67.0)
Shipping Volume		cu.ft (m ³)	13.41 (0.38)		

DATA SUBJECT TO CHANGE WITHOUT NOTICE.

Remarks:

- The values shown in performance section and electrical rating section above are based on the following unit combination.
 For other combination unit, please refer to the "Unit Combination Tables" in this manual.
 Indoor Unit : CS-MKS9NKU 3units Outdoor Unit : CU-3KS19NBU 1unit
- Rating conditions are: Cooling : Indoor air temp. 80 °F DB / 67 °F WB
 Outdoor air temp. 95 °F DB / 75 °F WB

Outdoor Unit **CU-3KS19NBU**
 Indoor Unit **CS-MKS9NKU × 3**

< 208V >

Type		3-Room Multi Outdoor Unit		
Number of Connectable Indoor Units		3		
Number of Operatable Indoor Units		3		
Voltage Rating		208V Single-Phase 60Hz		
		Cooling		
Performance	Total Capacity	BTU/h	18,800 (9,800 to 18,800)	
		kW	5.50 (2.90 to 5.50)	
	Sensible Capacity	BTU/h	16,000	
	Latent Capacity	BTU/h	2,800	
	Air Circulation (High)	ft ³ /min (m ³ /h)	1,707 (2,900)	
Electrical Rating	Available Voltage Range	V	187 to 253	
	Running Amperes	A	7.4	
	Power Input	W	1,500	
	Power Factor	%	98	
	EER	BTU/h/W	12.5	
	Compressor Locked Rotor Amperes	A	13.0	
	Fuse or Circuit Breaker Capacity	A	15	
			Outdoor Unit	
Features	Control		Microprocessor	
	Fan Speeds		Auto (Hi, Me, Lo)	
	Compressor		DC Twin Rotary (Inverter)	
	Refrigerant / Amount charged at shipment	lbs (g)	R410A / 6.17 (2,800)	
	Refrigerant Control		Electric Expansion Valve	
	Operation Sound (High) Cool	dB-A	50	
	Refrigerant Tubing Connections		Flare Type	
	Max. allowable tubing length per unit	ft (m)	82 (25)	
	Refrigerant	Narrow tube inch (mm)	1/4 (6.35) × 3	
	Tube Diameter	Wide tube inch (mm)	3/8 (9.52) × 3	
		Outdoor Unit		
Dimensions & Weight	Unit Dimensions		29-1/8 × 35-7/16 × 12-19/32	
	Height × Width × Depth	(mm)	(740 × 900 × 320)	
	Package Dimensions		34-3/16 × 41-11/32 × 16-21/32	
	Height × Width × Depth	(mm)	(868 × 1,050 × 423)	
	Weight	Net	lbs (kg)	138.9 (63.0)
		Shipping	lbs (kg)	147.7 (67.0)
Shipping Volume		cu.ft (m ³)	13.41 (0.38)	

DATA SUBJECT TO CHANGE WITHOUT NOTICE.

Remarks:

- The values shown in performance section and electrical rating section above are based on the following unit combination.
 For other combination unit, please refer to the "Unit Combination Tables" in this manual.
 Indoor Unit : CS-MKS9NKU 3units Outdoor Unit : CU-3KS19NBU 1unit
- Rating conditions are: Cooling : Indoor air temp. 80 °F DB / 67 °F WB
 Outdoor air temp. 95 °F DB / 75 °F WB

Outdoor Unit **CU-4KS24NBU**

Indoor Unit **CS-MKS7NKU + CS-MKS9NKU × 2**

Duct Less Type Rated

< 230V >

Type		4-Room Multi Outdoor Unit	
Number of Connectable Indoor Units		4	
Number of Operatable Indoor Units		4	
Voltage Rating		230V Single-Phase 60Hz	
Performance	Cooling		
	Total Capacity	BTU/h	24,200 (9,800 to 25,400)
		kW	7.10 (2.90 to 7.50)
	Sensible Capacity	BTU/h	20,300
	Latent Capacity	BTU/h	3,900
	Air Circulation (High)	ft ³ /min (m ³ /h)	1,707 (2,900)
Electrical Rating	Available Voltage Range	V	187 to 253
	Running Amperes	A	10.7
	Power Input	W	2,420
	Power Factor	%	98
	EER	BTU/h/W	10.0
	SEER	BTU/Wh	18.0
	Compressor Locked Rotor Amperes	A	13.0
	Fuse or Circuit Breaker Capacity	A	20
Features			Outdoor Unit
	Control		Microprocessor
	Fan Speeds		Auto (Hi, Me, Lo)
	Compressor		DC Twin Rotary (Inverter)
	Refrigerant / Amount charged at shipment	lbs (g)	R410A / 6.17 (2,800)
	Refrigerant Control		Electric Expansion Valve
	Operation Sound (High) Cool	dB-A	50
	Refrigerant Tubing Connections		Flare Type
	Max. allowable tubing length per unit	ft (m)	82 (25)
	Refrigerant	Narrow tube inch (mm)	1/4 (6.35) × 4
Tube Diameter	Wide tube inch (mm)	3/8 (9.52) × 3 + 1/2 (12.7) × 1	
Dimensions & Weight			Outdoor Unit
	Unit Dimensions	inch	29-1/8 × 35-7/16 × 12-19/32
	Height × Width × Depth	(mm)	(740 × 900 × 320)
	Package Dimensions	inch	34-3/16 × 41-11/32 × 16-21/32
	Height × Width × Depth	(mm)	(868 × 1,050 × 423)
	Weight	Net lbs (kg)	138.9 (63.0)
	Shipping lbs (kg)	147.7 (67.0)	
Shipping Volume	cu.ft (m ³)	13.41 (0.38)	

DATA SUBJECT TO CHANGE WITHOUT NOTICE.

Remarks:

- The values shown in performance section and electrical rating section above are based on the following unit combination.
For other combination unit, please refer to the "Unit Combination Tables" in this manual.
Indoor Unit : CS-MKE7NKU 1units / CS-MKE9NKU 2units Outdoor Unit : CU-4KS24NBU 1unit
The combination indoor unit is AHRI 210/240.
- Rating conditions are: Cooling : Indoor air temp. 80 °F DB / 67 °F WB
Outdoor air temp. 95 °F DB / 75 °F WB

Outdoor Unit **CU-4KS24NBU**
 Indoor Unit **CS-MKS9NKU × 3**

< 230V >

Type		4-Room Multi Outdoor Unit		
Number of Connectable Indoor Units		4		
Number of Operatable Indoor Units		4		
Voltage Rating		230V Single-Phase 60Hz		
		Cooling		
Performance	Total Capacity	BTU/h	25,400 (9,800 to 25,400)	
		kW	7.50 (2.90 to 7.50)	
	Sensible Capacity	BTU/h	21,400	
	Latent Capacity	BTU/h	4,000	
	Air Circulation (High)	ft ³ /min (m ³ /h)	1,707 (2,900)	
Electrical Rating	Available Voltage Range	V	187 to 253	
	Running Amperes	A	11.3	
	Power Input	W	2,560	
	Power Factor	%	98	
	EER	BTU/h/W	9.9	
	Compressor Locked Rotor Amperes	A	13.0	
	Fuse or Circuit Breaker Capacity	A	20	
		Outdoor Unit		
Features	Control	Microprocessor		
	Fan Speeds	Auto (Hi, Me, Lo)		
	Compressor	DC Twin Rotary (Inverter)		
	Refrigerant / Amount charged at shipment	lbs (g)	R410A / 6.17 (2,800)	
	Refrigerant Control	Electric Expansion Valve		
	Operation Sound (High) Cool	dB-A	50	
	Refrigerant Tubing Connections	Flare Type		
	Max. allowable tubing length per unit	ft (m)	82 (25)	
	Refrigerant	Narrow tube	inch (mm)	1/4 (6.35) × 4
	Tube Diameter	Wide tube	inch (mm)	3/8 (9.52) × 3 + 1/2 (12.7) × 1
		Outdoor Unit		
Dimensions & Weight	Unit Dimensions	inch	29-1/8 × 35-7/16 × 12-19/32	
	Height × Width × Depth	(mm)	(740 × 900 × 320)	
	Package Dimensions	inch	34-3/16 × 41-11/32 × 16-21/32	
	Height × Width × Depth	(mm)	(868 × 1,050 × 423)	
	Weight	Net	lbs (kg)	138.9 (63.0)
		Shipping	lbs (kg)	147.7 (67.0)
	Shipping Volume	cu.ft (m ³)	13.41 (0.38)	

DATA SUBJECT TO CHANGE WITHOUT NOTICE.

Remarks:

- The values shown in performance section and electrical rating section above are based on the following unit combination.
 For other combination unit, please refer to the "Unit Combination Tables" in this manual.
 Indoor Unit : CS-MKS9NKU 3units Outdoor Unit : CU-4KS24NBU 1unit
- Rating conditions are: Cooling : Indoor air temp. 80 °F DB / 67 °F WB
 Outdoor air temp. 95 °F DB / 75 °F WB

Outdoor Unit **CU-4KS24NBU**
 Indoor Unit **CS-MKS9NKU × 3**

< 208V >

Type		4-Room Multi Outdoor Unit			
Number of Connectable Indoor Units		4			
Number of Operatable Indoor Units		4			
Voltage Rating		208V Single-Phase 60Hz			
		Cooling			
Performance	Total Capacity	BTU/h	24,400 (9,800 to 24,400)		
		kW	7.20 (2.90 to 7.20)		
	Sensible Capacity	BTU/h	20,600		
	Latent Capacity	BTU/h	3,800		
	Air Circulation (High)	ft ³ /min (m ³ /h)	1,707 (2,900)		
Electrical Rating	Available Voltage Range		V	187 to 253	
	Running Amperes		A	12.1	
	Power Input		W	2,460	
	Power Factor		%	98	
	EER		BTU/h/W	9.9	
	Compressor Locked Rotor Amperes		A	13.0	
	Fuse or Circuit Breaker Capacity		A	20	
			Outdoor Unit		
Features	Control		Microprocessor		
	Fan Speeds		Auto (Hi, Me, Lo)		
	Compressor		DC Twin Rotary (Inverter)		
	Refrigerant / Amount charged at shipment		lbs (g)	R410A / 6.17 (2,800)	
	Refrigerant Control		Electric Expansion Valve		
	Operation Sound (High) Cool		dB-A	50	
	Refrigerant Tubing Connections		Flare Type		
	Max. allowable tubing length per unit		ft (m)	82 (25)	
	Refrigerant		Narrow tube	inch (mm)	1/4 (6.35) × 4
	Tube Diameter		Wide tube	inch (mm)	3/8 (9.52) × 3 + 1/2 (12.7) × 1
		Outdoor Unit			
Dimensions & Weight	Unit Dimensions		inch	29-1/8 × 35-7/16 × 12-19/32	
	Height × Width × Depth		(mm)	(740 × 900 × 320)	
	Package Dimensions		inch	34-3/16 × 41-11/32 × 16-21/32	
	Height × Width × Depth		(mm)	(868 × 1,050 × 423)	
	Weight		Net	lbs (kg)	138.9 (63.0)
			Shipping	lbs (kg)	147.7 (67.0)
Shipping Volume		cu.ft (m ³)		13.41 (0.38)	

DATA SUBJECT TO CHANGE WITHOUT NOTICE.

Remarks:

- The values shown in performance section and electrical rating section above are based on the following unit combination.
 For other combination unit, please refer to the "Unit Combination Tables" in this manual.
 Indoor Unit : CS-MKS9NKU 3units Outdoor Unit : CU-4KS24NBU 1unit
- Rating conditions are: Cooling : Indoor air temp. 80 °F DB / 67 °F WB
 Outdoor air temp. 95 °F DB / 75 °F WB

Outdoor Unit **CU-4KS31NBU**

Indoor Unit **CS-MKS7NKU × 3 + CS-MKS9NKU**

Duct Less Type Rated

< 230V >

Type		4-Room Multi Outdoor Unit		
Number of Connectable Indoor Units		4		
Number of Operatable Indoor Units		4		
Voltage Rating		230V Single-Phase 60Hz		
Performance			Cooling	
	Total Capacity	BTU/h kW	29,000 (9,800 to 29,000) 8.50 (2.90 to 8.50)	
	Sensible Capacity	BTU/h	24,400	
	Latent Capacity	BTU/h	4,600	
Air Circulation (High)	ft ³ /min (m ³ /h)	1,942 (3,300)		
Electrical Rating	Available Voltage Range	V	187 to 253	
	Running Amperes	A	11.4	
	Power Input	W	2,600	
	Power Factor	%	99	
	EER	BTU/h/W	11.2	
	SEER	BTU/Wh	17.6	
	Compressor Locked Rotor Amperes	A	17.0	
	Fuse or Circuit Breaker Capacity	A	20	
Features			Outdoor Unit	
	Control	Microprocessor		
	Fan Speeds	Auto (Hi, Me, Lo)		
	Compressor	DC Twin Rotary (Inverter)		
	Refrigerant / Amount charged at shipment	lbs (g)	R410A / 8.38 (3,800)	
	Refrigerant Control	Electric Expansion Valve		
	Operation Sound (High) Cool	dB-A	53	
	Refrigerant Tubing Connections	Flare Type		
	Max. allowable tubing length per unit	ft (m)	100 (30.5)	
	Refrigerant	Narrow tube inch (mm)	1/4 (6.35) × 4	
Tube Diameter	Wide tube inch (mm)	3/8 (9.52) × 2 + 1/2 (12.7) × 2		
Dimensions & Weight			Outdoor Unit	
	Unit Dimensions	inch	35-1/32 × 35-7/16 × 12-19/32	
	Height × Width × Depth	(mm)	(890 × 900 × 320)	
	Package Dimensions	inch	40-1/8 × 41-11/32 × 16-21/32	
	Height × Width × Depth	(mm)	(1,019 × 1,050 × 423)	
	Weight	Net Shipping	lbs (kg)	174.2 (79.0) 183.0 (83.0)
Shipping Volume		cu.ft (m ³)	15.88 (0.45)	

DATA SUBJECT TO CHANGE WITHOUT NOTICE.

Remarks:

- The values shown in performance section and electrical rating section above are based on the following unit combination.
For other combination unit, please refer to the "Unit Combination Tables" in this manual.
Indoor Unit : CS-MKE7NKU 3units / CS-MKE9NKU 1units Outdoor Unit : CU-4KS31NBU 1unit
The combination indoor unit is AHRI 210/240.
- Rating conditions are: Cooling : Indoor air temp. 80 °F DB / 67 °F WB
Outdoor air temp. 95 °F DB / 75 °F WB

Outdoor Unit **CU-4KS31NBU**
 Indoor Unit **CS-MKS9NKU × 4**

< 230V >

Type		4-Room Multi Outdoor Unit		
Number of Connectable Indoor Units		4		
Number of Operatable Indoor Units		4		
Voltage Rating		230V Single-Phase 60Hz		
		Cooling		
Performance	Total Capacity	BTU/h	30,600 (9,800 to 30,600)	
		kW	9.00 (2.90 to 9.00)	
	Sensible Capacity	BTU/h	25,800	
	Latent Capacity	BTU/h	4,800	
	Air Circulation (High)	ft ³ /min (m ³ /h)	1,942 (3,300)	
Electrical Rating	Available Voltage Range		V 187 to 253	
	Running Amperes		A 12.3	
	Power Input		W 2,800	
	Power Factor		% 99	
	EER	BTU/h/W	10.9	
	Compressor Locked Rotor Amperes		A 17.0	
	Fuse or Circuit Breaker Capacity		A 20	
			Outdoor Unit	
Features	Control		Microprocessor	
	Fan Speeds		Auto (Hi, Me, Lo)	
	Compressor		DC Twin Rotary (Inverter)	
	Refrigerant / Amount charged at shipment	lbs (g)	R410A / 8.38 (3,800)	
	Refrigerant Control		Electric Expansion Valve	
	Operation Sound (High) Cool	dB-A	53	
	Refrigerant Tubing Connections		Flare Type	
	Max. allowable tubing length per unit	ft (m)	100 (30.5)	
	Refrigerant	Narrow tube inch (mm)	1/4 (6.35) × 4	
	Tube Diameter	Wide tube inch (mm)	3/8 (9.52) × 2 + 1/2 (12.7) × 2	
		Outdoor Unit		
Dimensions & Weight	Unit Dimensions		inch 35-1/32 × 35-7/16 × 12-19/32	
	Height × Width × Depth		(mm) (890 × 900 × 320)	
	Package Dimensions		inch 40-1/8 × 41-11/32 × 16-21/32	
	Height × Width × Depth		(mm) (1,019 × 1,050 × 423)	
	Weight	Net	lbs (kg)	174.2 (79.0)
		Shipping	lbs (kg)	183.0 (83.0)
Shipping Volume		cu.ft (m ³)	15.88 (0.45)	

DATA SUBJECT TO CHANGE WITHOUT NOTICE.

Remarks:

- The values shown in performance section and electrical rating section above are based on the following unit combination.
 For other combination unit, please refer to the "Unit Combination Tables" in this manual.
 Indoor Unit : CS-MKS9NKU 4units Outdoor Unit : CU-4KS31NBU 1unit
- Rating conditions are: Cooling : Indoor air temp. 80 °F DB / 67 °F WB
 Outdoor air temp. 95 °F DB / 75 °F WB

Outdoor Unit **CU-4KS31NBU**
 Indoor Unit **CS-MKS9NKU × 4**

< 208V >

Type		4-Room Multi Outdoor Unit		
Number of Connectable Indoor Units		4		
Number of Operatable Indoor Units		4		
Voltage Rating		208V Single-Phase 60Hz		
		Cooling		
Performance	Total Capacity	BTU/h	28,600 (9,800 to 28,600)	
		kW	8.40 (2.90 to 8.40)	
	Sensible Capacity	BTU/h	24,200	
	Latent Capacity	BTU/h	4,400	
	Air Circulation (High)	ft ³ /min (m ³ /h)	1,942 (3,300)	
Electrical Rating	Available Voltage Range	V	187 to 253	
	Running Amperes	A	12.7	
	Power Input	W	2,560	
	Power Factor	%	99	
	EER	BTU/h/W	11.2	
	Compressor Locked Rotor Amperes	A	17.0	
	Fuse or Circuit Breaker Capacity	A	20	
			Outdoor Unit	
Features	Control		Microprocessor	
	Fan Speeds		Auto (Hi, Me, Lo)	
	Compressor		DC Twin Rotary (Inverter)	
	Refrigerant / Amount charged at shipment	lbs (g)	R410A / 8.38 (3,800)	
	Refrigerant Control		Electric Expansion Valve	
	Operation Sound (High) Cool	dB-A	53	
	Refrigerant Tubing Connections		Flare Type	
	Max. allowable tubing length per unit	ft (m)	100 (30.5)	
	Refrigerant	Narrow tube inch (mm)	1/4 (6.35) × 4	
	Tube Diameter	Wide tube inch (mm)	3/8 (9.52) × 2 + 1/2 (12.7) × 2	
		Outdoor Unit		
Dimensions & Weight	Unit Dimensions		inch	
	Height × Width × Depth	(mm)	35-1/32 × 35-7/16 × 12-19/32 (890 × 900 × 320)	
	Package Dimensions		inch	
	Height × Width × Depth	(mm)	40-1/8 × 41-11/32 × 16-21/32 (1,019 × 1,050 × 423)	
	Weight	Net	lbs (kg)	174.2 (79.0)
		Shipping	lbs (kg)	183.0 (83.0)
Shipping Volume		cu.ft (m ³)	15.88 (0.45)	

DATA SUBJECT TO CHANGE WITHOUT NOTICE.

Remarks:

- The values shown in performance section and electrical rating section above are based on the following unit combination.
 For other combination unit, please refer to the "Unit Combination Tables" in this manual.
 Indoor Unit : CS-MKS9NKU 4units Outdoor Unit : CU-4KS31NBU 1unit
- Rating conditions are: Cooling : Indoor air temp. 80 °F DB / 67 °F WB
 Outdoor air temp. 95 °F DB / 75 °F WB

2-2. Major Component Specifications

2-2-1. Outdoor Unit

Outdoor Unit **CU-3KS19NBU**

Control PCB	
Part No.	CB-CU-3KS19NBU
Controls	Microprocessor
Control Circuit Fuse	250V 25A

Compressor	
Type	DC Twin Rotary (Hermetic)
Compressor Model / Nominal Output	5KD240XAB21 / 1,700W
Compressor Oil ... Amount	Pints (cc) FV50S ... 1.91 (900)
Coil Resistance (Ambient Temp. 68 °F (20 °C))	Ohm U - V : 0.720 V - W : 0.708 W - U : 0.726
Safety Device	
CT (Peak current cut-off control)	Yes
Compressor Discharge Temp. Control	Yes
Operation cut-off control in abnormal ambient Temp.	Yes
Overload Relay	Model CS-7L-2515
	Operation Temp. Open : 239 °F (115 °C), Close : 212 °F (100 °C)
Run Capacitor	Micro F -
	VAC -
Crankcase Heater	230V 30W

Fan	
Type	Propeller
Q'ty ... Dia.	inch (mm) 1 ... D18-1/8 (D460)

Fan Motor	
Type	DC Motor
Model ... Q'ty	SIC-71FW-D490-1 ... 1
No. of Poles	8
Rough Measure RPM (Cool)	750
Nominal Output	W 90
Coil Resistance	Ohm -
(Ambient Temp. 68 °F (20 °C))	
Safety Device	
Type	Internal Controller
Over-Current Protection	Yes
Over-Heat Protection	Yes
Run Capacitor	Micro F -
	VAC -

Heat Exchanger Coil	
Coil	Aluminum Plate Fin / Copper Tube
Rows	2
Fins per inch	18.1
Face Area	ft ² (m ²) 6.40 (0.595)

External Finish	Acrylic baked-on enamel finish
------------------------	--------------------------------

DATA SUBJECT TO CHANGE WITHOUT NOTICE.

Outdoor Unit **CU-4KS24NBU**

Control PCB	
Part No.	CB-CU-4KS24NBU
Controls	Microprocessor
Control Circuit Fuse	250V 25A

Compressor	
Type	DC Twin Rotary (Hermetic)
Compressor Model / Nominal Output	5KD240XAB21 / 1,700W
Compressor Oil ... Amount	Pints (cc) FV50S ... 1.91 (900)
Coil Resistance (Ambient Temp. 68 °F (20 °C))	Ohm U - V : 0.720 V - W : 0.708 W - U : 0.726
Safety Device	
CT (Peak current cut-off control)	Yes
Compressor Discharge Temp. Control	Yes
Operation cut-off control in abnormal ambient Temp.	Yes
Overload Relay	Model CS-7L-2515
	Operation Temp. Open : 239 °F (115 °C), Close : 212 °F (100 °C)
Run Capacitor	Micro F -
	VAC -
Crankcase Heater	230V 30W

Fan	
Type	Propeller
Q'ty ... Dia.	inch (mm) 1 ... D18-1/8 (D460)

Fan Motor	
Type	DC Motor
Model ... Q'ty	SIC-71FW-D490-1 ... 1
No. of Poles	8
Rough Measure RPM (Cool)	750
Nominal Output	W 90
Coil Resistance	Ohm
(Ambient Temp. 68 °F (20 °C))	-
Safety Device	
Type	Internal Controller
Over-Current Protection	Yes
Over-Heat Protection	Yes
Run Capacitor	Micro F -
	VAC -

Heat Exchanger Coil	
Coil	Aluminum Plate Fin / Copper Tube
Rows	2
Fins per inch	18.1
Face Area	ft ² (m ²) 6.40 (0.595)

External Finish	Acrylic baked-on enamel finish
------------------------	--------------------------------

DATA SUBJECT TO CHANGE WITHOUT NOTICE.

Outdoor Unit **CU-4KS31NBU**

Control PCB	
Part No.	CB-CU-4KS31NBU
Controls	Microprocessor
Control Circuit Fuse	250V 25A

Compressor	
Type	DC Twin Rotary (Hermetic)
Compressor Model / Nominal Output	5JD420XAB22 / 3,000W
Compressor Oil ... Amount	Pints (cc) FV50S ... 2.55 (1,200)
Coil Resistance (Ambient Temp. 68 °F (20 °C))	Ohm U - V : 0.435 V - W : 0.441 W - U : 0.452
Safety Device	
CT (Peak current cut-off control)	Yes
Compressor Discharge Temp. Control	Yes
Operation cut-off control in abnormal ambient Temp.	Yes
Overload Relay	Model CS-7L-2515
	Operation Temp. Open : 239 °F (115 °C), Close : 212 °F (100 °C)
Run Capacitor	Micro F -
	VAC -
Crankcase Heater	230V 30W

Fan	
Type	Propeller
Q'ty ... Dia.	inch (mm) 1 ... D18-1/8 (D460)

Fan Motor	
Type	DC Motor
Model ... Q'ty	SIC-71FW-D490-1 ... 1
No. of Poles	8
Rough Measure RPM (Cool)	800
Nominal Output	W 90
Coil Resistance	Ohm
(Ambient Temp. 68 °F (20 °C))	-
Safety Device	
Type	Internal Controller
Over-Current Protection	Yes
Over-Heat Protection	Yes
Run Capacitor	Micro F -
	VAC -

Heat Exchanger Coil	
Coil	Aluminum Plate Fin / Copper Tube
Rows	2
Fins per inch	18.1
Face Area	ft ² (m ²) 7.75 (0.72)

External Finish	Acrylic baked-on enamel finish
------------------------	--------------------------------

DATA SUBJECT TO CHANGE WITHOUT NOTICE.

2-3. Other Component Specifications

Sensor Name	Model No. of sensor	Quantity of Sensor		
		CU-3KS19NBU	CU-4KS24NBU	CU-4KS31NBU
Outdoor air temp sensor	TKS295B	1	1	1
Outdoor heat exchanger sensor	TKS292B	1	1	1
AW / AN sensor	TKS292B	1 / 1	1 / 1	1 / 1
BW / BN sensor	TKS292B	1 / 1	1 / 1	1 / 1
CW / CN sensor	TKS292B	1 / 1	1 / 1	1 / 1
DW / DN sensor	TKS292B	0	1 / 1	1 / 1

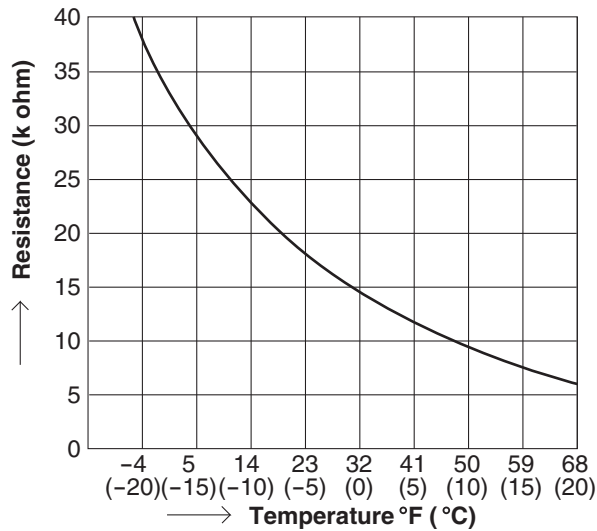

Sensor Name	Model No. of sensor	Quantity of Sensor		
		CU-3KS19NBU	CU-4KS24NBU	CU-4KS31NBU
Compressor temp sensor	TKS293B	1	1	1

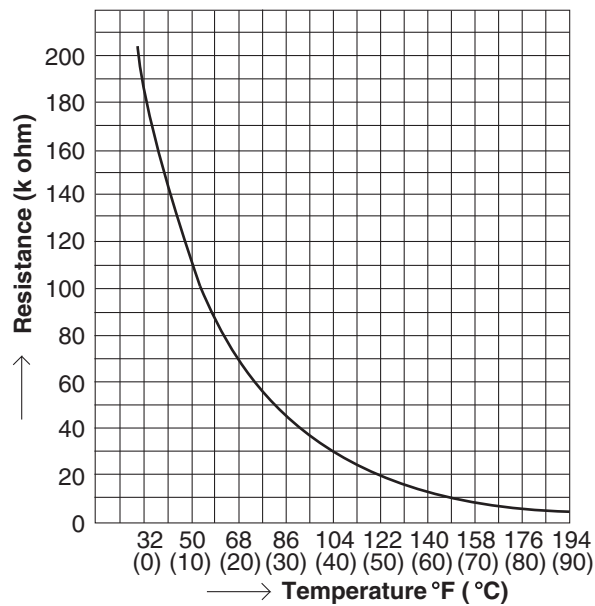

3. DIMENSIONAL DATA

Outdoor Unit CU-3KS19NBU

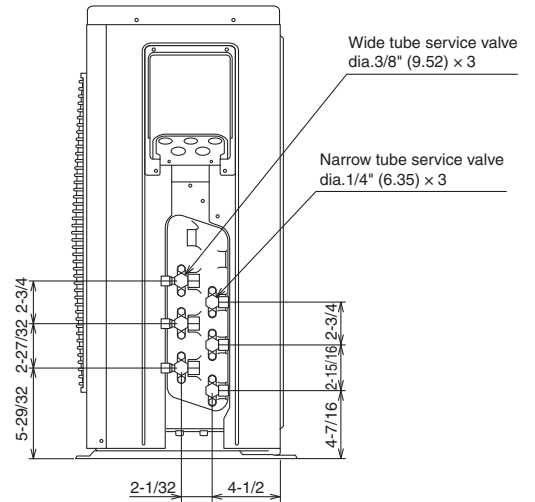
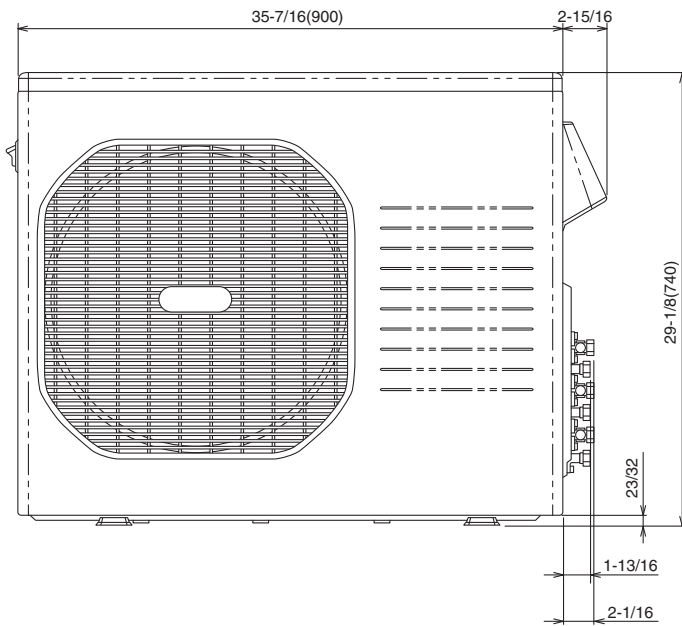
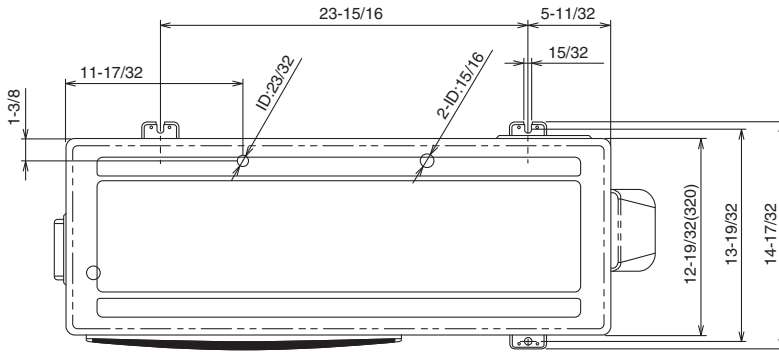

Unit: inch(mm)
(852-0-0010-11500-0)

Outdoor Unit **CU-4KS24NBU**

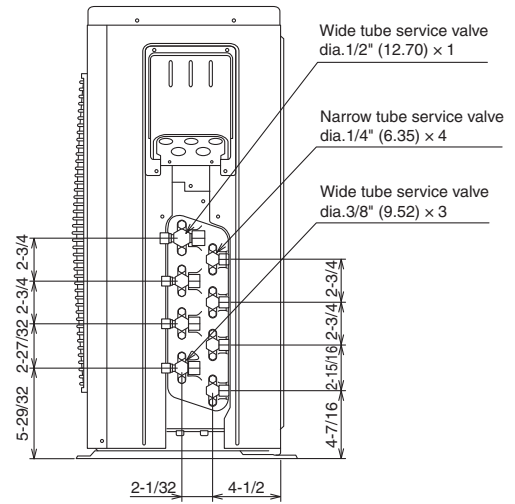
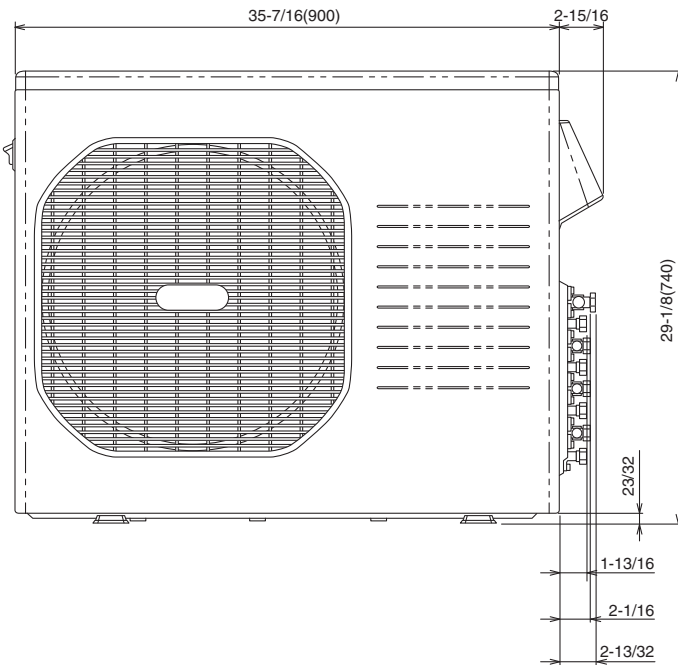
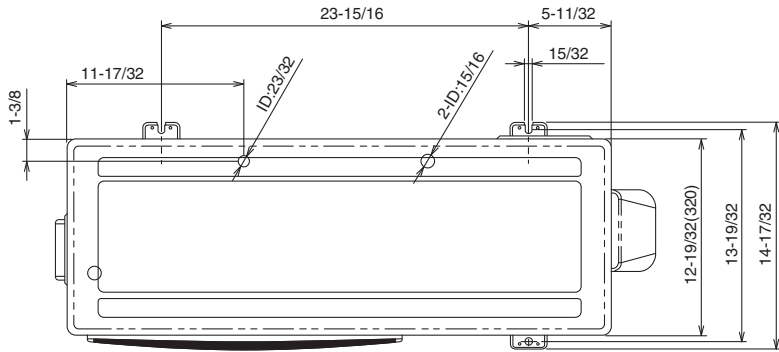

Unit: inch(mm)
(852-0-0010-20500-0)

4. REFRIGERANT FLOW DIAGRAM

4-1. Refrigerant Flow Diagram

Outdoor Unit CU-3KS19NBU

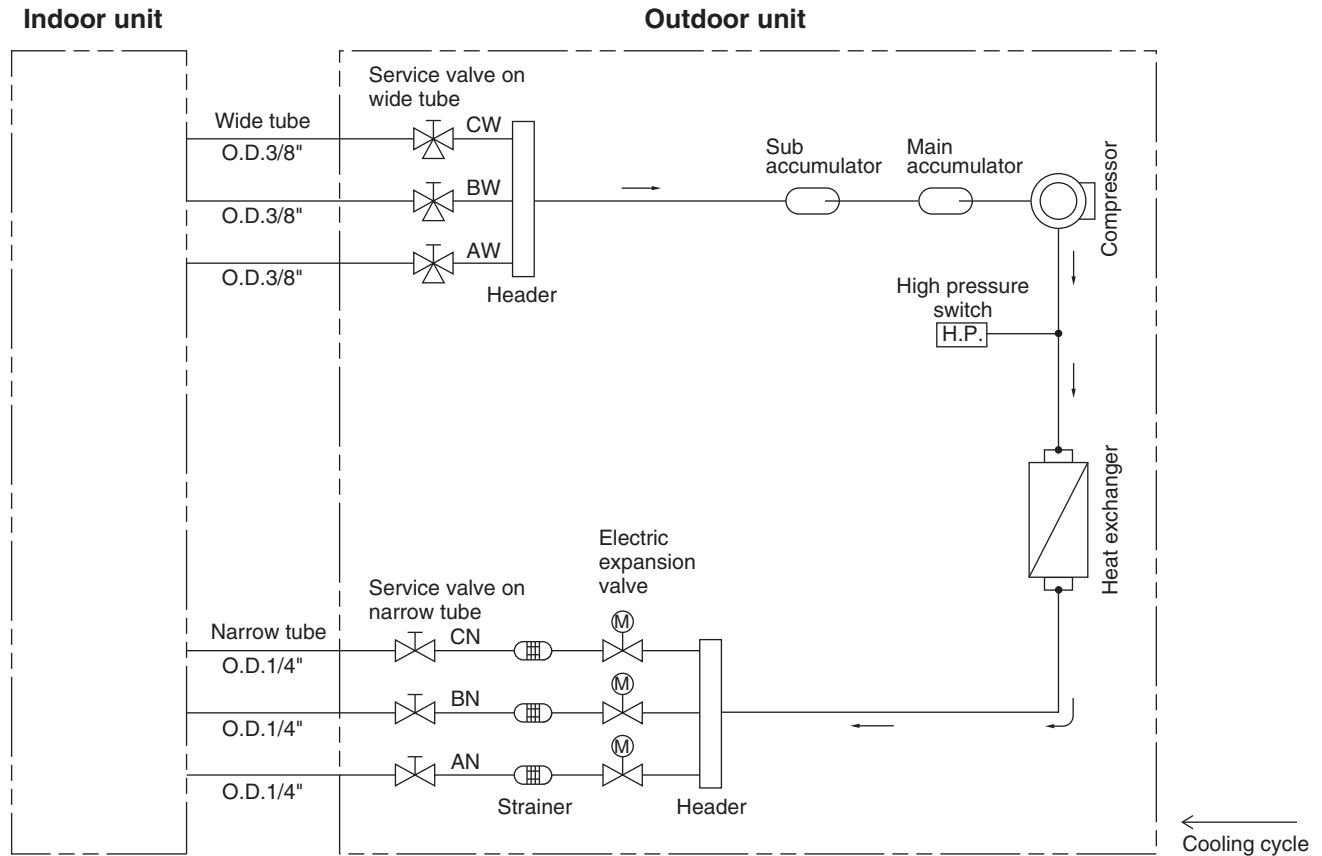

Insulation of Refrigerant Tubing

IMPORTANT

Because capillary tubing is used in the outdoor unit, both the wide and narrow tubes of this air conditioner become cold. To prevent heat loss and wet floors due to dripping of condensation, **both tubes must be well insulated** with a proper insulation material. The thickness of the insulation should be a min.5/16"(8 mm).

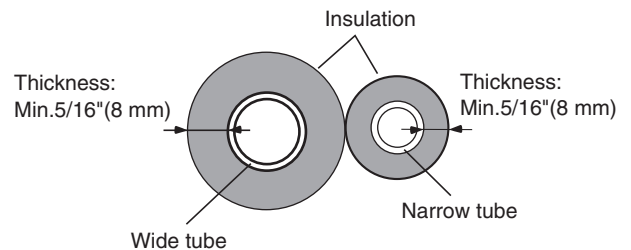

CAUTION

After a tube has been insulated, never try to bend it into a narrow curve because it can cause the tube to break or crack.

Outdoor Unit **CU-4KS24NBU**

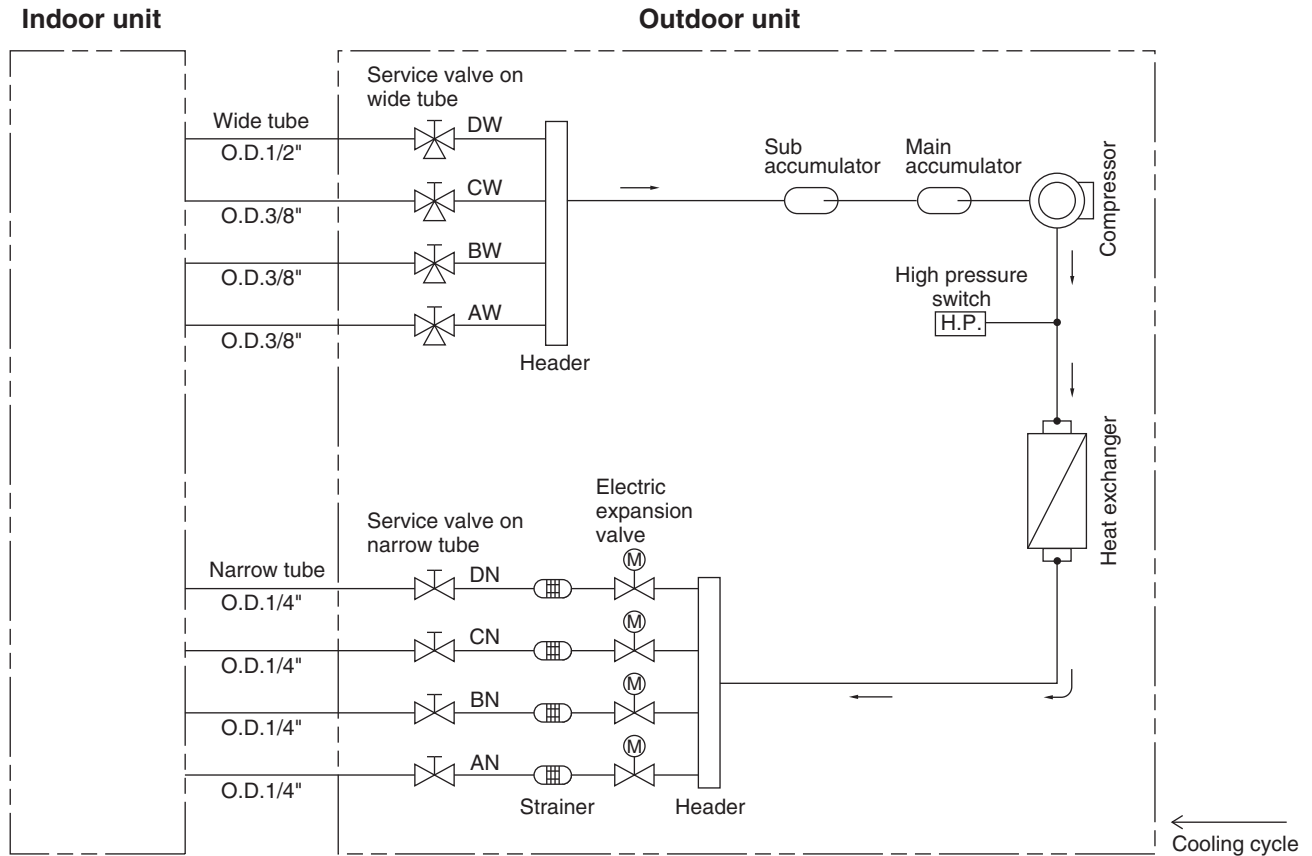

Insulation of Refrigerant Tubing

IMPORTANT

Because capillary tubing is used in the outdoor unit, both the wide and narrow tubes of this air conditioner become cold. To prevent heat loss and wet floors due to dripping of condensation, **both tubes must be well insulated** with a proper insulation material. The thickness of the insulation should be a min.5/16"(8 mm).

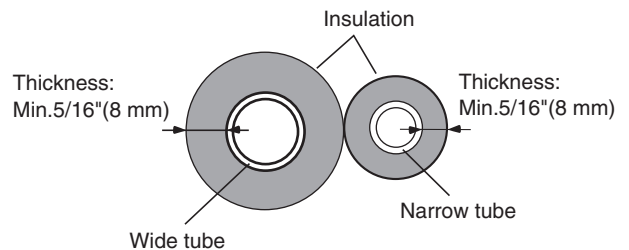

CAUTION

After a tube has been insulated, never try to bend it into a narrow curve because it can cause the tube to break or crack.

Outdoor Unit **CU-4KS31NBU**

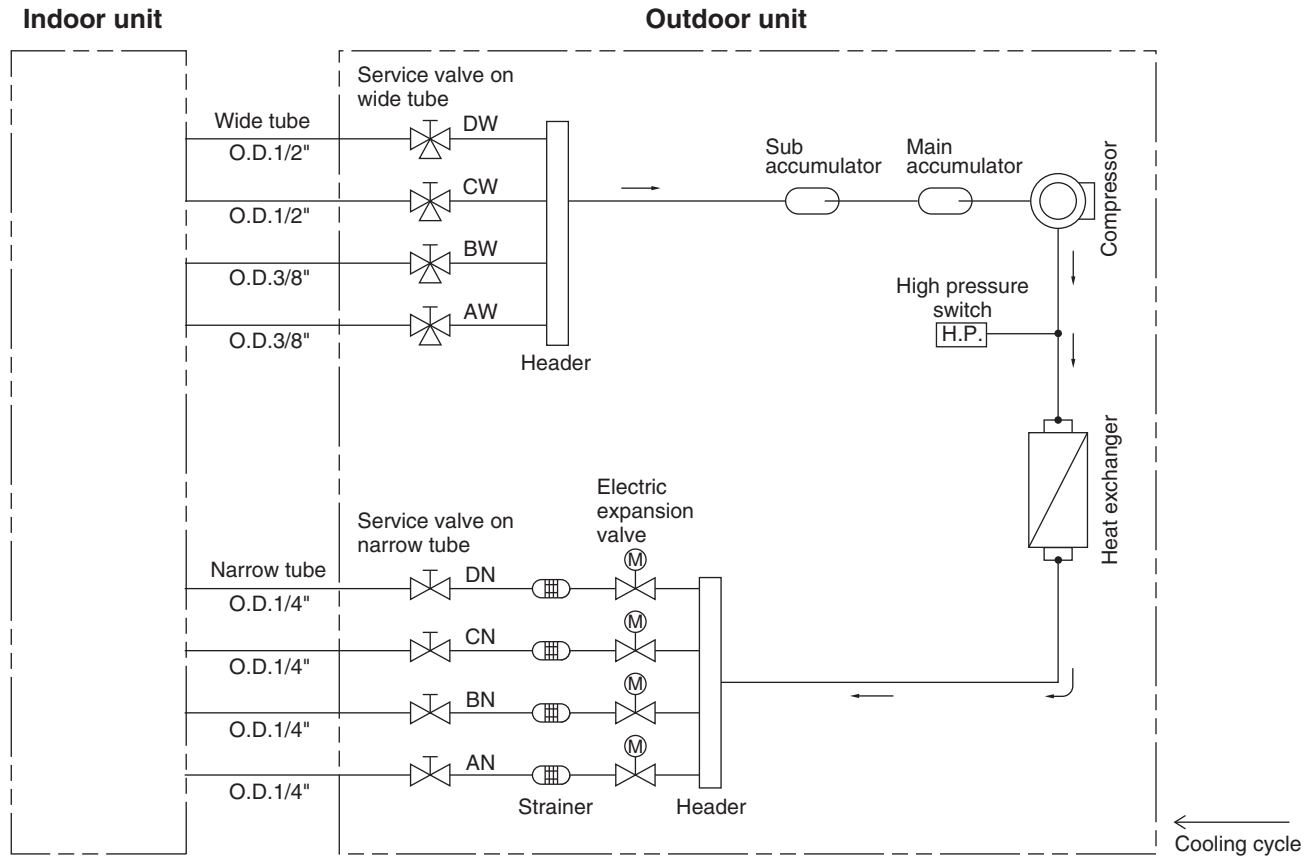

Insulation of Refrigerant Tubing

IMPORTANT

Because capillary tubing is used in the outdoor unit, both the wide and narrow tubes of this air conditioner become cold. To prevent heat loss and wet floors due to dripping of condensation, **both tubes must be well insulated** with a proper insulation material. The thickness of the insulation should be a min.5/16"(8 mm).

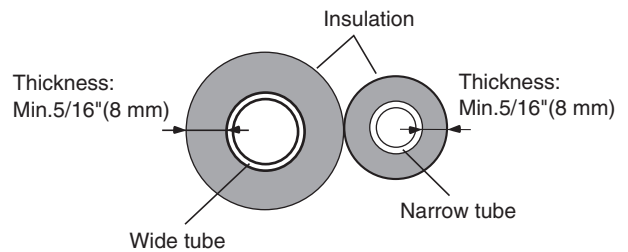

CAUTION

After a tube has been insulated, never try to bend it into a narrow curve because it can cause the tube to break or crack.

5. PERFORMANCE DATA

5-1. Temperature Charts

5-1-1. Temperature Charts (CU-3KS19NBU)

Outdoor Unit **CU-3KS19NBU** Indoor Unit **CS-MKS7NKU × 1**

■ Cooling Characteristics

(RH : 46%, Indoor fan speed : High fan)
(230V, 60Hz)

(1) Low pressure performance chart

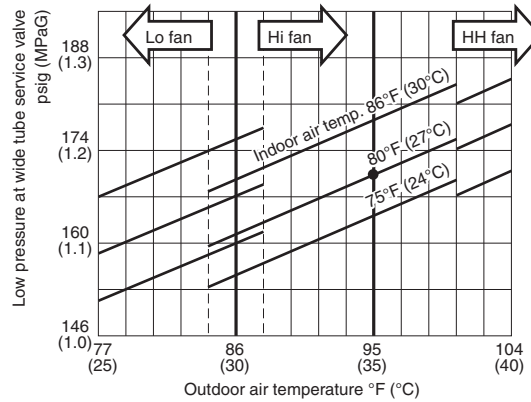

(2) Operating current performance chart

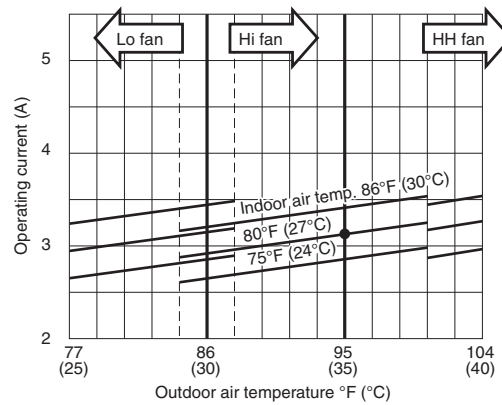

(3) Indoor discharge air performance chart

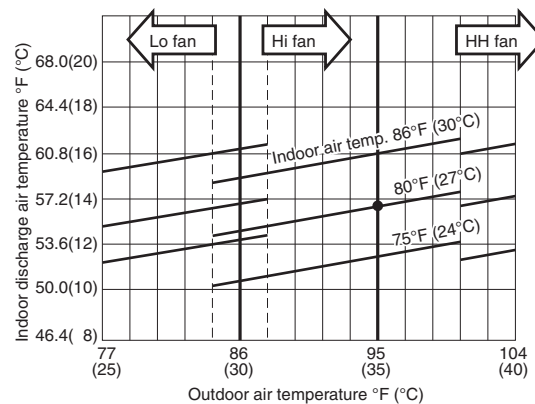

NOTE

- This performance chart shows operation of a single wall-mounted indoor unit. The performance chart will vary depending on the indoor unit type.
- Check each performance value in test-run mode. Electrical performance values represent a combined indoor/outdoor value. (In this case, be sure to stop all the indoor units where performance is not being checked.)
- The performance is for a tubing length of 24.6t (7.5m). If the tubing length is different, the performance chart will vary.

Outdoor Unit **CU-3KS19NBU** Indoor Unit **CS-MKS9NKU × 1**

■ **Cooling Characteristics**

(RH : 46%, Indoor fan speed : High fan)
(230V, 60Hz)

(1) Low pressure performance chart

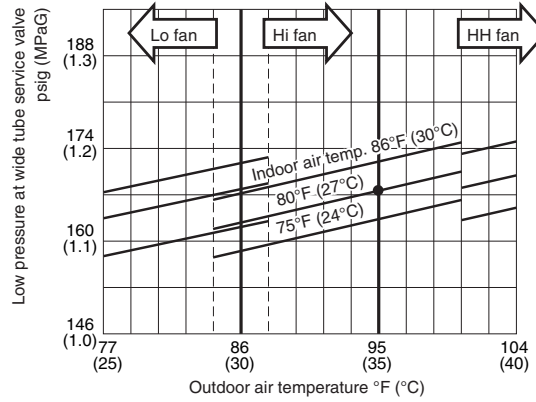

(2) Operating current performance chart

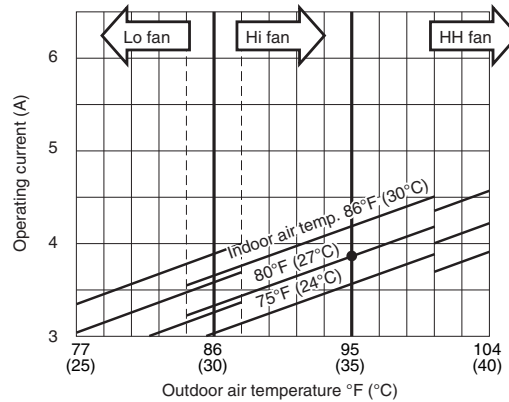

(3) Indoor discharge air performance chart

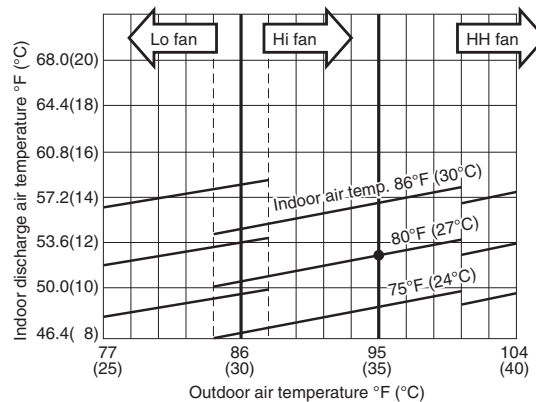

NOTE

- This performance chart shows operation of a single wall-mounted indoor unit. The performance chart will vary depending on the indoor unit type.
- Check each performance value in test-run mode. Electrical performance values represent a combined indoor/outdoor value. (In this case, be sure to stop all the indoor units where performance is not being checked.)
- The performance is for a tubing length of 24.6ft (7.5m). If the tubing length is different, the performance chart will vary.

Outdoor Unit **CU-3KS19NBU** Indoor Unit **CS-MKS12NKU × 1**

■ **Cooling Characteristics**

(RH : 46%, Indoor fan speed : High fan)
(230V, 60Hz)

(1) Low pressure performance chart

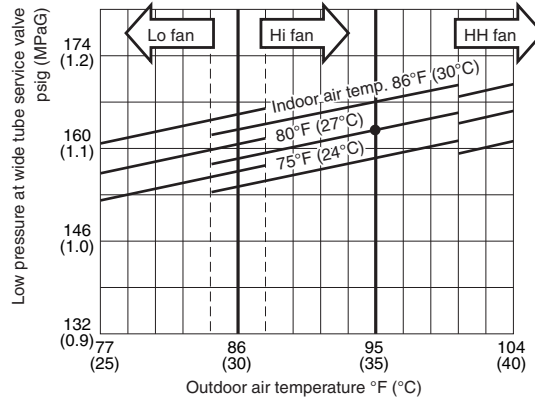

(2) Operating current performance chart

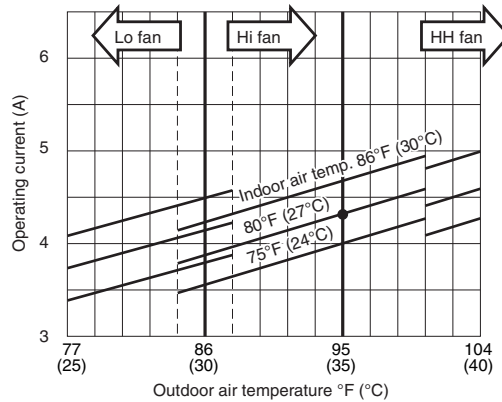

(3) Indoor discharge air performance chart

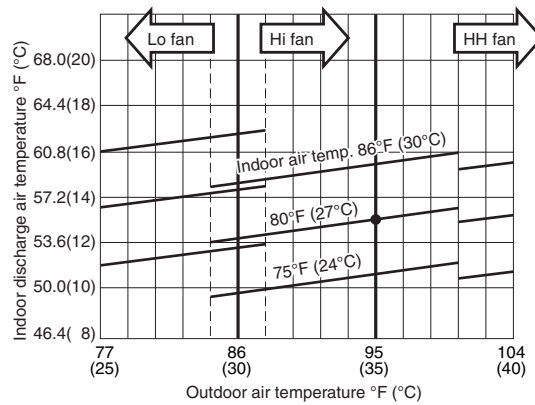

NOTE

- This performance chart shows operation of a single wall-mounted indoor unit. The performance chart will vary depending on the indoor unit type.
- Check each performance value in test-run mode. Electrical performance values represent a combined indoor/outdoor value. (In this case, be sure to stop all the indoor units where performance is not being checked.)
- The performance is for a tubing length of 24.6ft (7.5m). If the tubing length is different, the performance chart will vary.

Outdoor Unit **CU-3KS19NBU** Indoor Unit **CS-MKS18NKU x 1**

■ **Cooling Characteristics**

(RH : 46%, Indoor fan speed : High fan)
(230V, 60Hz)

(1) Low pressure performance chart

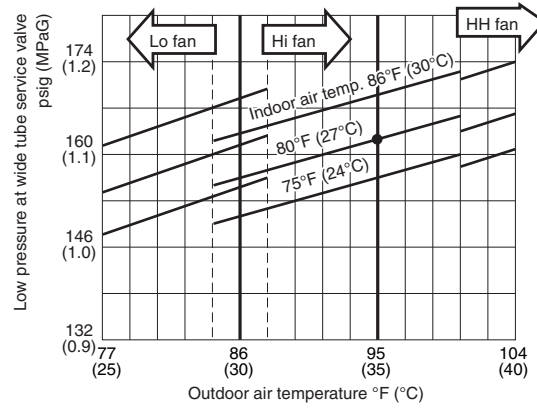

(2) Operating current performance chart

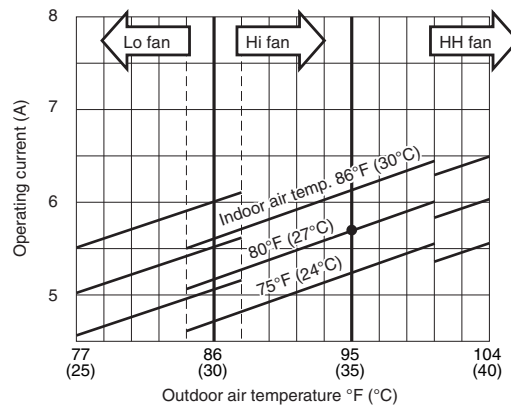

(3) Indoor discharge air performance chart

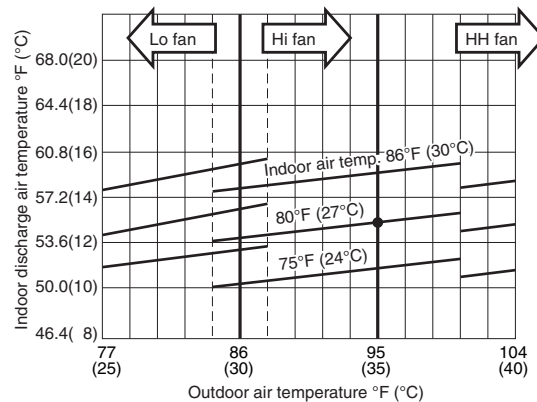

NOTE

- This performance chart shows operation of a single wall-mounted indoor unit. The performance chart will vary depending on the indoor unit type.
- Check each performance value in test-run mode. Electrical performance values represent a combined indoor/outdoor value. (In this case, be sure to stop all the indoor units where performance is not being checked.)
- The performance is for a tubing length of 24.6ft (7.5m). If the tubing length is different, the performance chart will vary.

Outdoor Unit **CU-3KS19NBU** Indoor Unit **CS-MKS9NB4U × 1**

■ **Cooling Characteristics**

(RH : 46%, Indoor fan speed : High fan)
(230V, 60Hz)

(1) Low pressure performance chart

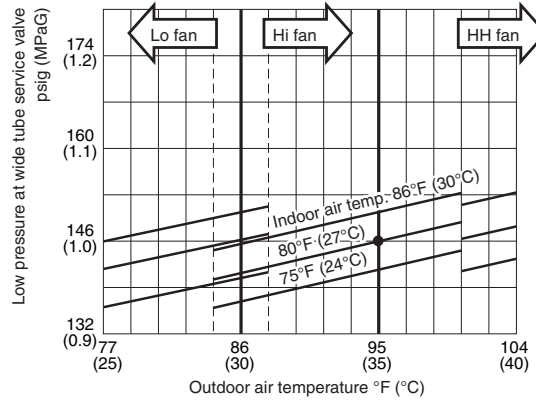

(2) Operating current performance chart

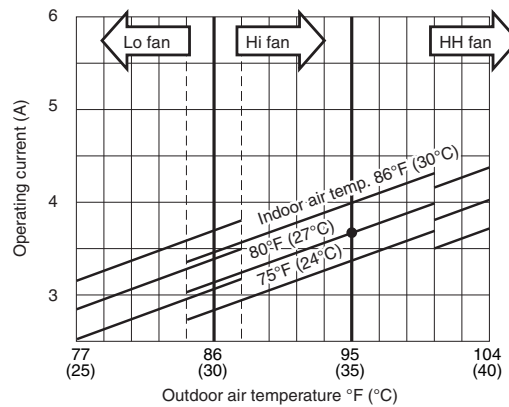

(3) Indoor discharge air performance chart

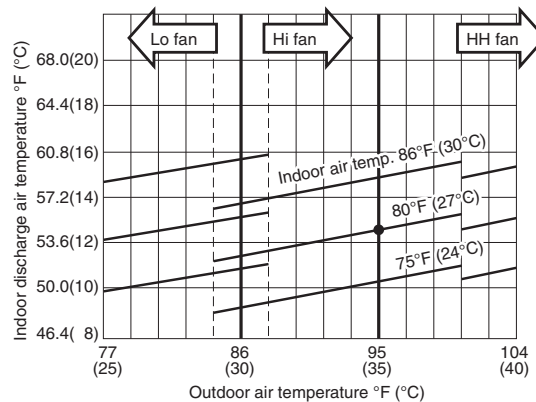

NOTE

- This performance chart shows operation of a single wall-mounted indoor unit. The performance chart will vary depending on the indoor unit type.
- Check each performance value in test-run mode. Electrical performance values represent a combined indoor/outdoor value. (In this case, be sure to stop all the indoor units where performance is not being checked.)
- The performance is for a tubing length of 24.6ft (7.5m). If the tubing length is different, the performance chart will vary.

Outdoor Unit **CU-3KS19NBU** Indoor Unit **CS-MKS12NB4U x 1**

■ **Cooling Characteristics**

(RH : 46%, Indoor fan speed : High fan)
(230V, 60Hz)

(1) **Low pressure performance chart**

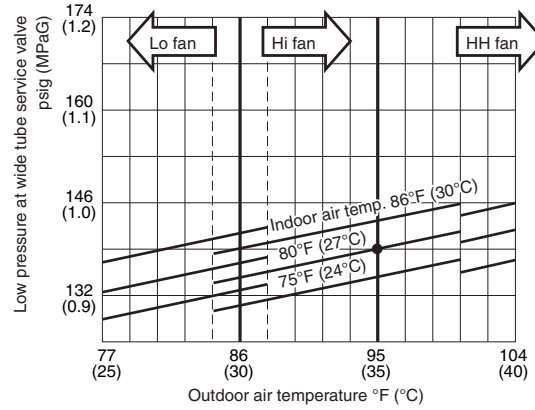

(2) **Operating current performance chart**

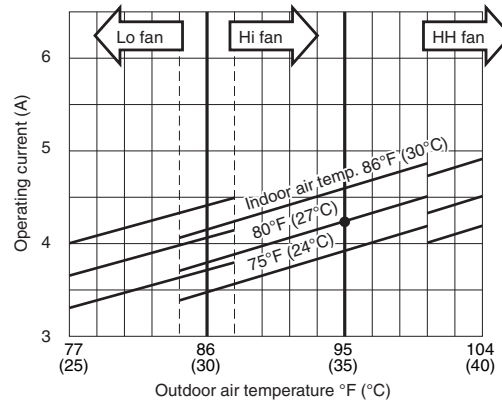

(3) **Indoor discharge air performance chart**

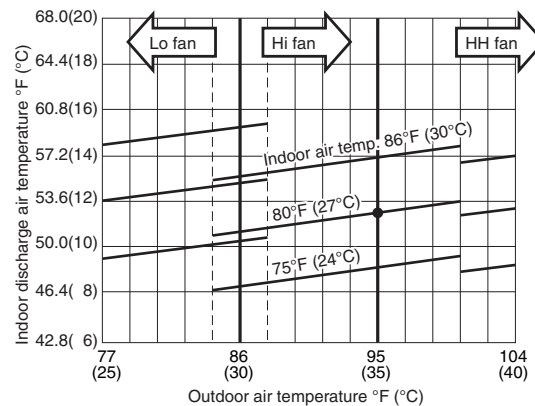

NOTE

- This performance chart shows operation of a single wall-mounted indoor unit. The performance chart will vary depending on the indoor unit type.
- Check each performance value in test-run mode. Electrical performance values represent a combined indoor/outdoor value. (In this case, be sure to stop all the indoor units where performance is not being checked.)
- The performance is for a tubing length of 24.6ft (7.5m). If the tubing length is different, the performance chart will vary.

Outdoor Unit **CU-3KS19NBU** Indoor Unit **CS-KS18NB4UW × 1**

■ **Cooling Characteristics**

(RH : 46%, Indoor fan speed : High fan)
(230V, 60Hz)

(1) Low pressure performance chart

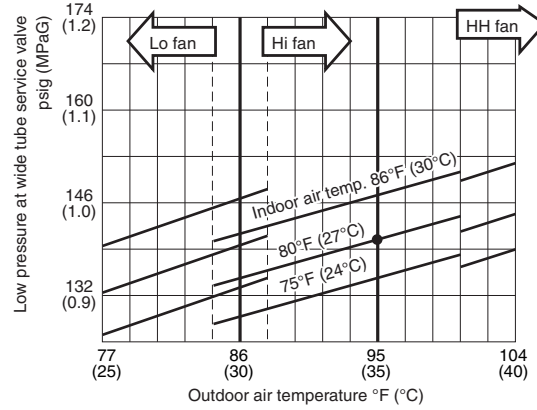

(2) Operating current performance chart

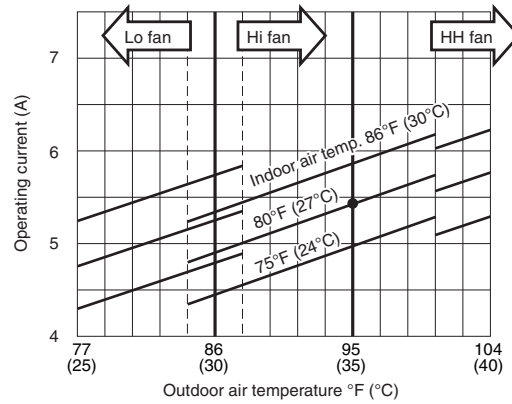

(3) Indoor discharge air performance chart

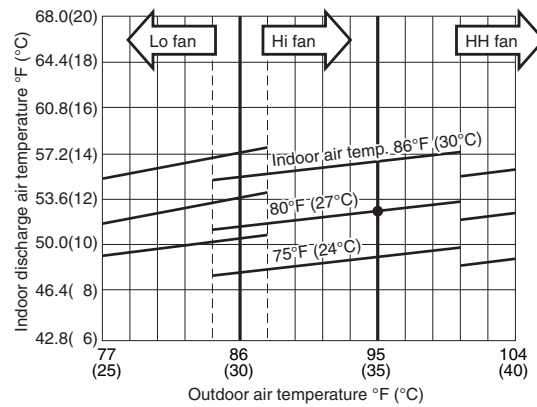

NOTE

- This performance chart shows operation of a single wall-mounted indoor unit. The performance chart will vary depending on the indoor unit type.
- Check each performance value in test-run mode. Electrical performance values represent a combined indoor/outdoor value. (In this case, be sure to stop all the indoor units where performance is not being checked.)
- The performance is for a tubing length of 24.6ft (7.5m). If the tubing length is different, the performance chart will vary.

5-1-2. Temperature Charts (CU-4KS24NBU)

Outdoor Unit **CU-4KS24NBU** Indoor Unit **CS-MKS7NKU × 1**

■ Cooling Characteristics

(RH : 46%, Indoor fan speed : High fan)
(230V, 60Hz)

(1) Low pressure performance chart

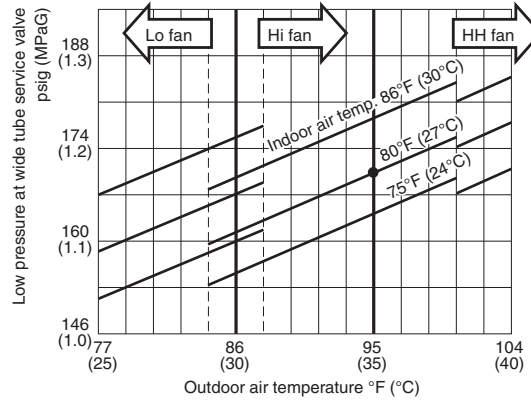

(2) Operating current performance chart

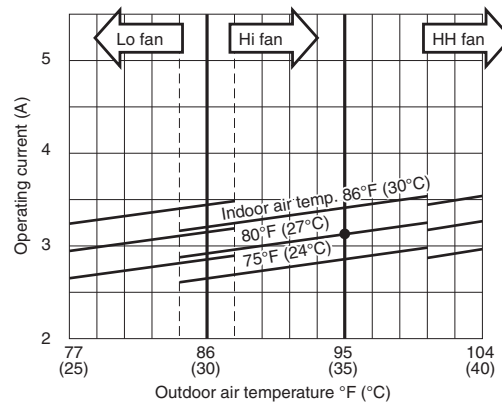

(3) Indoor discharge air performance chart

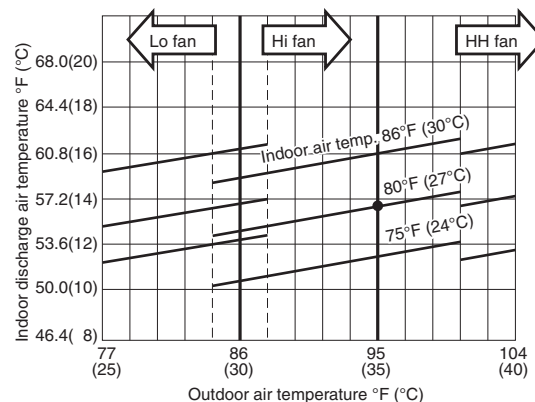

NOTE

- This performance chart shows operation of a single wall-mounted indoor unit. The performance chart will vary depending on the indoor unit type.
- Check each performance value in test-run mode. Electrical performance values represent a combined indoor/outdoor value. (In this case, be sure to stop all the indoor units where performance is not being checked.)
- The performance is for a tubing length of 24.6t (7.5m). If the tubing length is different, the performance chart will vary.

Outdoor Unit **CU-4KS24NBU** Indoor Unit **CS-MKS9NKU × 1**

■ **Cooling Characteristics**

(RH : 46%, Indoor fan speed : High fan)
(230V, 60Hz)

(1) Low pressure performance chart

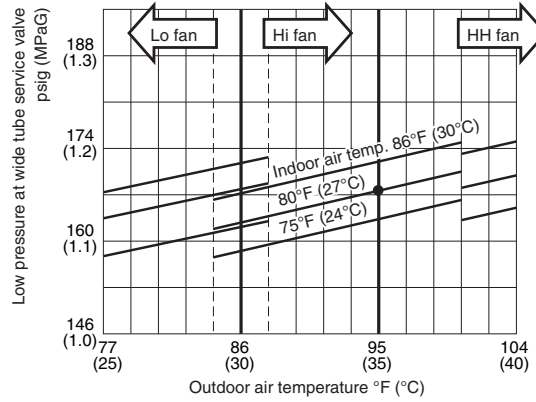

(2) Operating current performance chart

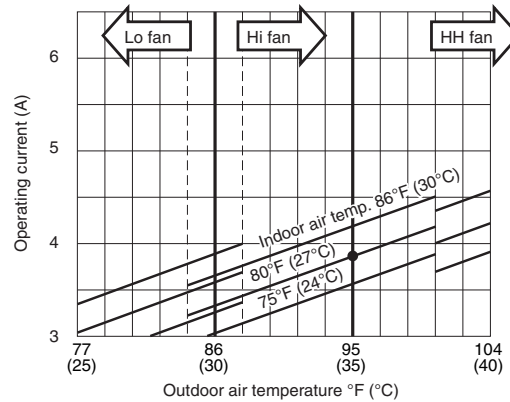

(3) Indoor discharge air performance chart

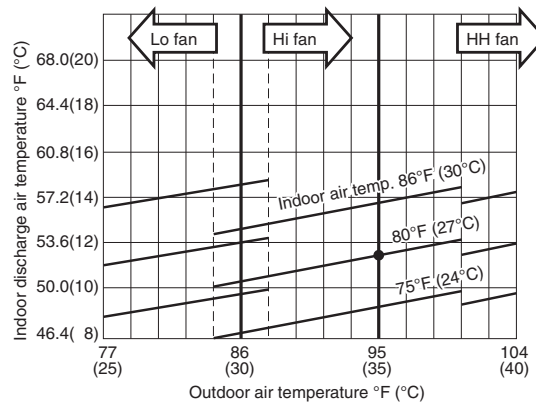

NOTE

- This performance chart shows operation of a single wall-mounted indoor unit. The performance chart will vary depending on the indoor unit type.
- Check each performance value in test-run mode. Electrical performance values represent a combined indoor/outdoor value. (In this case, be sure to stop all the indoor units where performance is not being checked.)
- The performance is for a tubing length of 24.6ft (7.5m). If the tubing length is different, the performance chart will vary.

Outdoor Unit **CU-4KS24NBU** Indoor Unit **CS-MKS12NKU × 1**

■ **Cooling Characteristics**

(RH : 46%, Indoor fan speed : High fan)
(230V, 60Hz)

(1) Low pressure performance chart

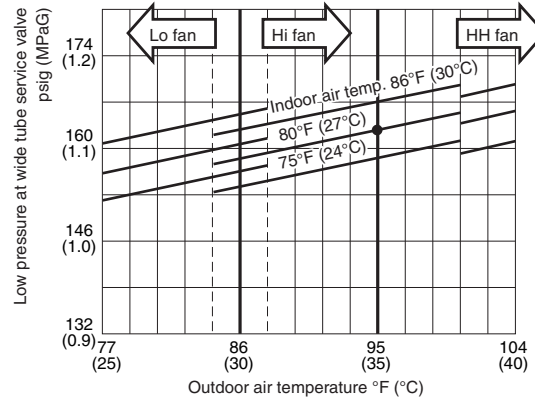

(2) Operating current performance chart

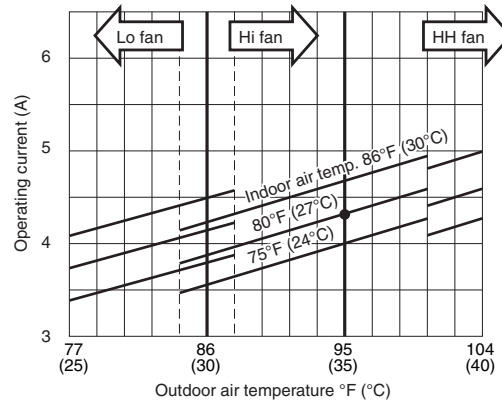

(3) Indoor discharge air performance chart

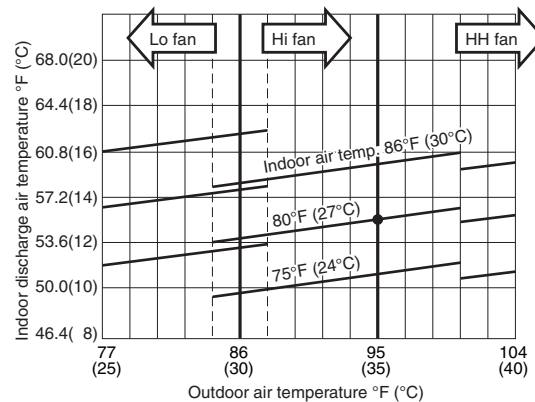

NOTE

- This performance chart shows operation of a single wall-mounted indoor unit. The performance chart will vary depending on the indoor unit type.
- Check each performance value in test-run mode. Electrical performance values represent a combined indoor/outdoor value. (In this case, be sure to stop all the indoor units where performance is not being checked.)
- The performance is for a tubing length of 24.6ft (7.5m). If the tubing length is different, the performance chart will vary.

Outdoor Unit **CU-4KS24NBU** Indoor Unit **CS-MKS18NKU x 1**

■ **Cooling Characteristics**

(RH : 46%, Indoor fan speed : High fan)
(230V, 60Hz)

(1) Low pressure performance chart

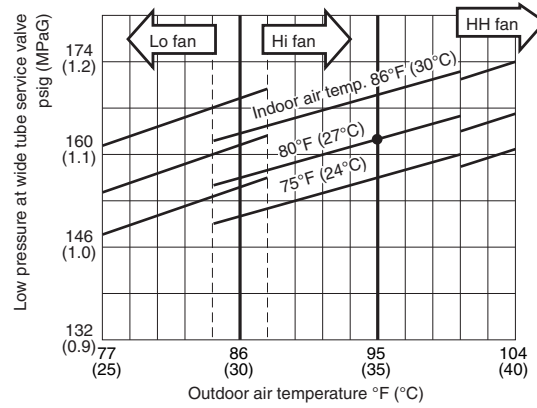

(2) Operating current performance chart

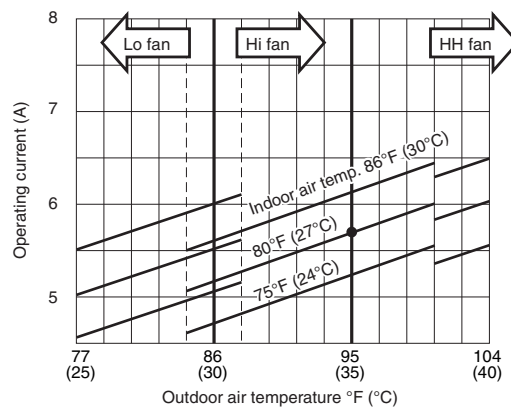

(3) Indoor discharge air performance chart

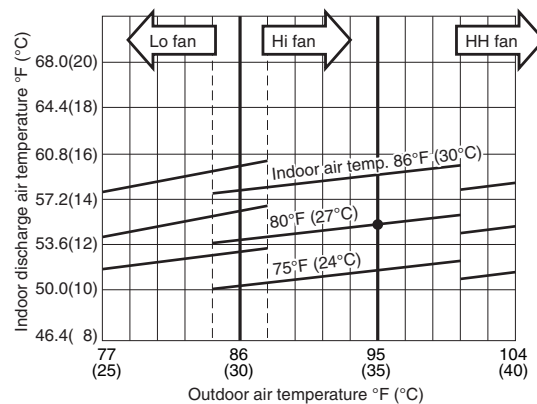

NOTE

- This performance chart shows operation of a single wall-mounted indoor unit. The performance chart will vary depending on the indoor unit type.
- Check each performance value in test-run mode. Electrical performance values represent a combined indoor/outdoor value. (In this case, be sure to stop all the indoor units where performance is not being checked.)
- The performance is for a tubing length of 24.6ft (7.5m). If the tubing length is different, the performance chart will vary.

Outdoor Unit **CU-4KS24NBU** Indoor Unit **CS-MKS24NKU x 1**

■ **Cooling Characteristics**

(RH : 46%, Indoor fan speed : High fan)
(230V, 60Hz)

(1) **Low pressure performance chart**

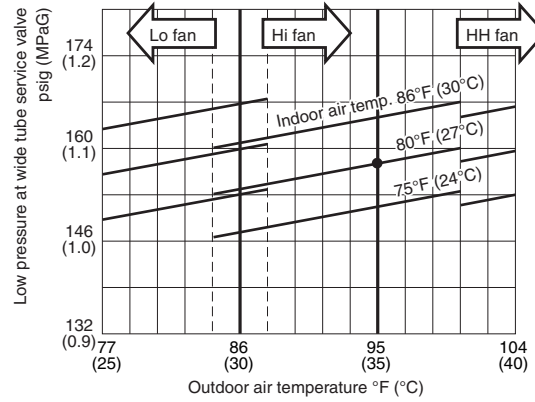

(2) **Operating current performance chart**

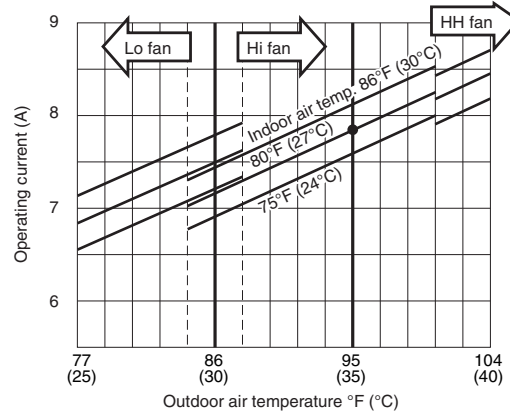

(3) **Indoor discharge air performance chart**

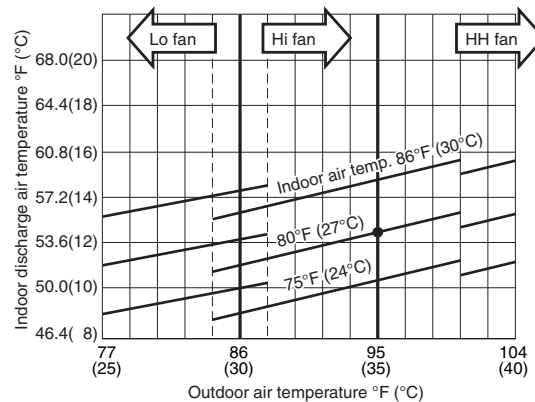

NOTE

- This performance chart shows operation of a single wall-mounted indoor unit. The performance chart will vary depending on the indoor unit type.
- Check each performance value in test-run mode. Electrical performance values represent a combined indoor/outdoor value. (In this case, be sure to stop all the indoor units where performance is not being checked.)
- The performance is for a tubing length of 24.6ft (7.5m). If the tubing length is different, the performance chart will vary.

Outdoor Unit **CU-4KS24NBU** Indoor Unit **CS-MKS9NB4U x 1**

■ **Cooling Characteristics**

(RH : 46%, Indoor fan speed : High fan)
(230V, 60Hz)

(1) Low pressure performance chart

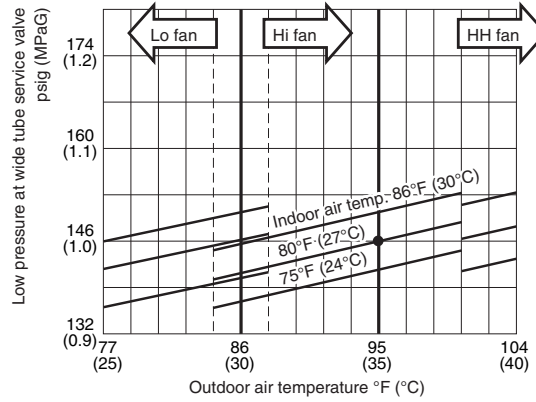

(2) Operating current performance chart

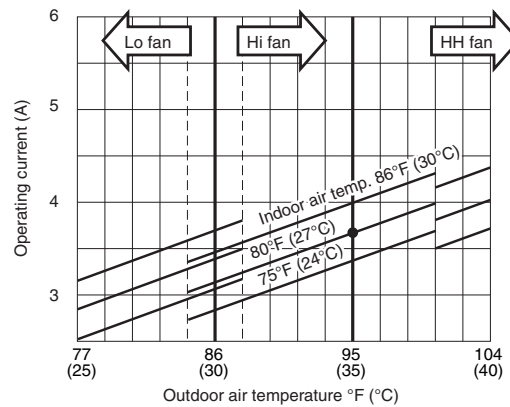

(3) Indoor discharge air performance chart

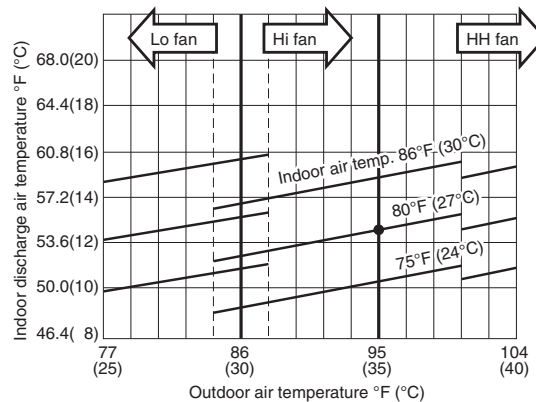

NOTE

- This performance chart shows operation of a single wall-mounted indoor unit. The performance chart will vary depending on the indoor unit type.
- Check each performance value in test-run mode. Electrical performance values represent a combined indoor/outdoor value. (In this case, be sure to stop all the indoor units where performance is not being checked.)
- The performance is for a tubing length of 24.6ft (7.5m). If the tubing length is different, the performance chart will vary.

Outdoor Unit **CU-4KS24NBU** Indoor Unit **CS-MKS12NB4U x 1**

■ **Cooling Characteristics**

(RH : 46%, Indoor fan speed : High fan)
(230V, 60Hz)

(1) **Low pressure performance chart**

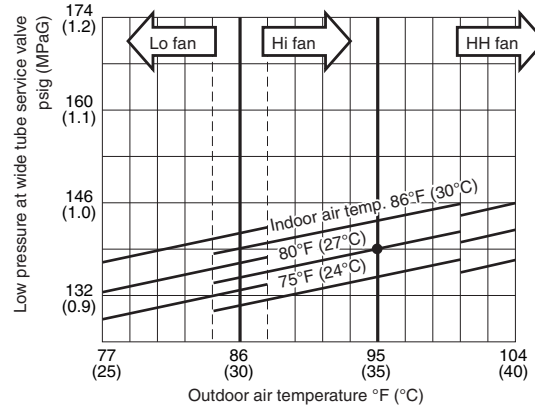

(2) **Operating current performance chart**

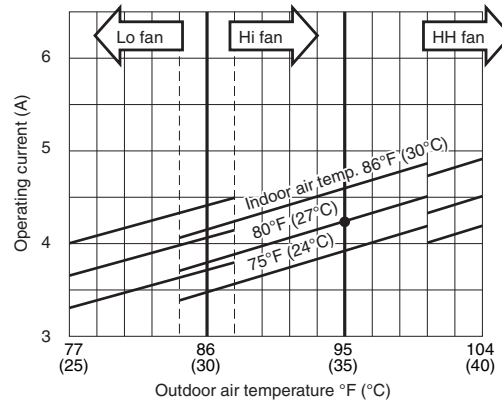

(3) **Indoor discharge air performance chart**

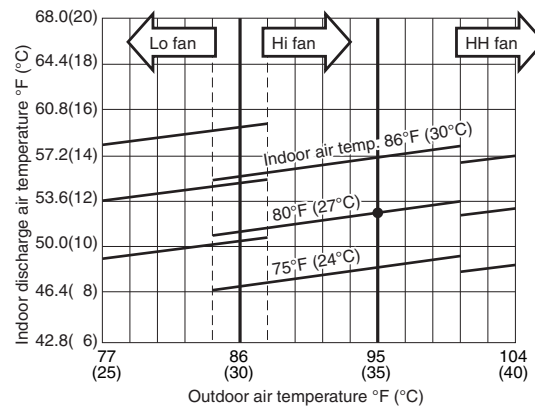

NOTE

- This performance chart shows operation of a single wall-mounted indoor unit. The performance chart will vary depending on the indoor unit type.
- Check each performance value in test-run mode. Electrical performance values represent a combined indoor/outdoor value. (In this case, be sure to stop all the indoor units where performance is not being checked.)
- The performance is for a tubing length of 24.6ft (7.5m). If the tubing length is different, the performance chart will vary.

Outdoor Unit **CU-4KS24NBU** Indoor Unit **CS-KS18NB4UW × 1**

■ **Cooling Characteristics**

(RH : 46%, Indoor fan speed : High fan)
(230V, 60Hz)

(1) Low pressure performance chart

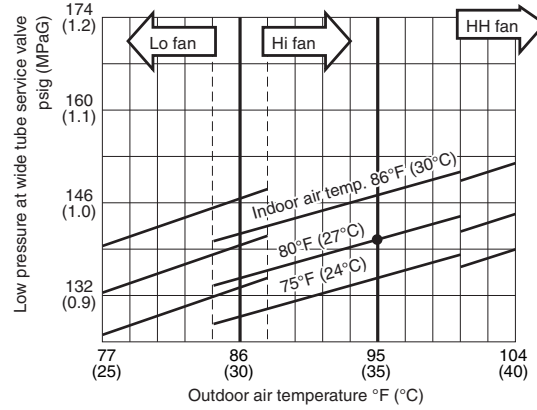

(2) Operating current performance chart

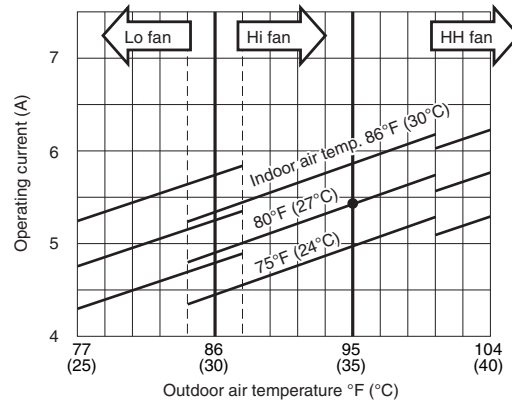

(3) Indoor discharge air performance chart

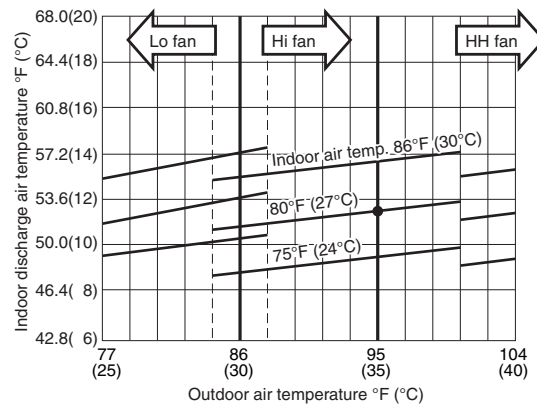

NOTE

- This performance chart shows operation of a single wall-mounted indoor unit. The performance chart will vary depending on the indoor unit type.
- Check each performance value in test-run mode. Electrical performance values represent a combined indoor/outdoor value. (In this case, be sure to stop all the indoor units where performance is not being checked.)
- The performance is for a tubing length of 24.6ft (7.5m). If the tubing length is different, the performance chart will vary.

5-1-3. Temperature Charts (CU-4KS31NBU)

Outdoor Unit **CU-4KS31NBU** Indoor Unit **CS-MKS7NKU 1**

■ Cooling Characteristics
 (RH : 46%, Indoor fan speed : High fan)
 (230V, 60Hz)

(1) Low pressure performance chart

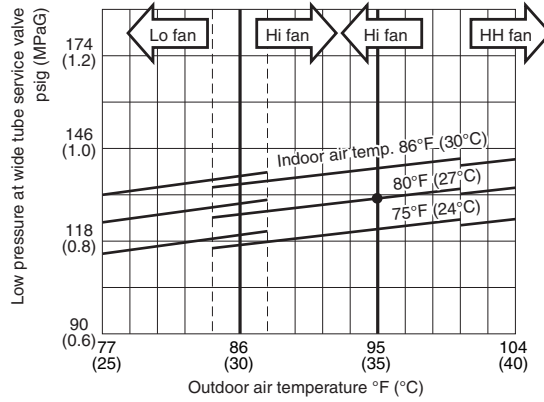

(2) Operating current performance chart

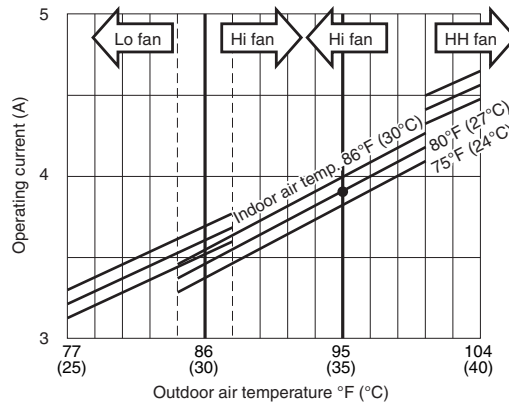

(3) Indoor discharge air performance chart

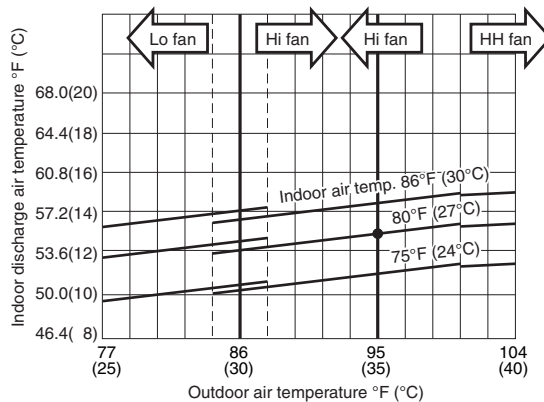

NOTE

- This performance chart shows operation of a single wall-mounted indoor unit. The performance chart will vary depending on the indoor unit type.
- Check each performance value in test-run mode. Electrical performance values represent a combined indoor/outdoor value. (In this case, be sure to stop all the indoor units where performance is not being checked.)
- The performance is for a tubing length of 24.6ft (7.5m). If the tubing length is different, the performance chart will vary.

Outdoor Unit **CU-4KS31NBU** Indoor Unit **CS-MKS9NKU × 1**

■ **Cooling Characteristics**

(RH : 46%, Indoor fan speed : High fan)
(230V, 60Hz)

(1) **Low pressure performance chart**

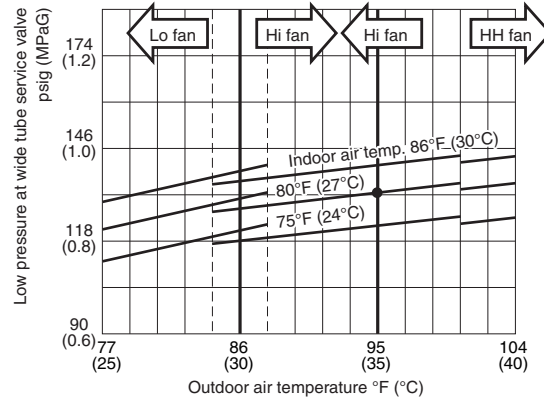

(2) **Operating current performance chart**

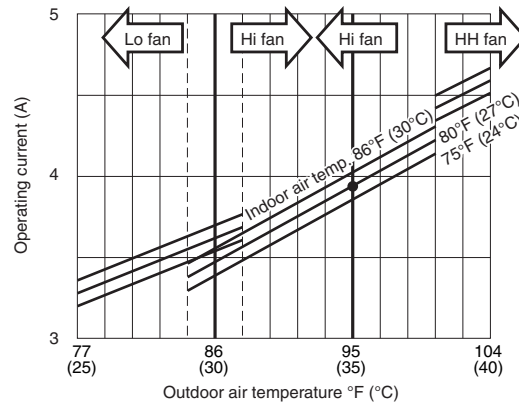

(3) **Indoor discharge air performance chart**

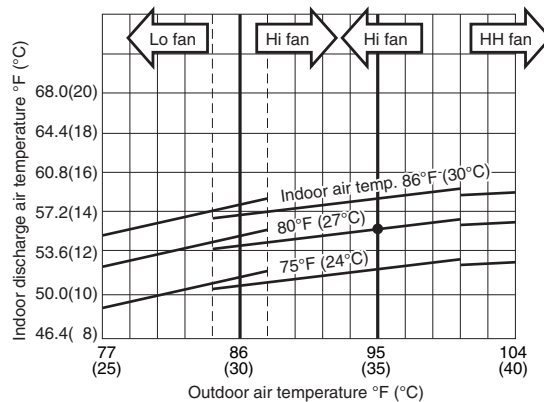

NOTE

- This performance chart shows operation of a single wall-mounted indoor unit. The performance chart will vary depending on the indoor unit type.
- Check each performance value in test-run mode. Electrical performance values represent a combined indoor/outdoor value. (In this case, be sure to stop all the indoor units where performance is not being checked.)
- The performance is for a tubing length of 24.6ft (7.5m). If the tubing length is different, the performance chart will vary.

Outdoor Unit **CU-4KS31NBU** Indoor Unit **CS-MKS12NKU × 1**

■ **Cooling Characteristics**

(RH : 46%, Indoor fan speed : High fan)
(230V, 60Hz)

(1) Low pressure performance chart

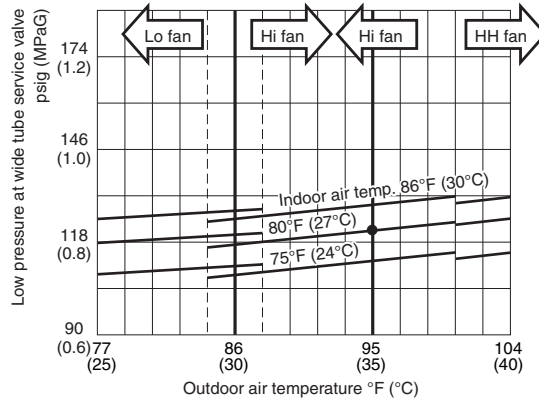

(2) Operating current performance chart

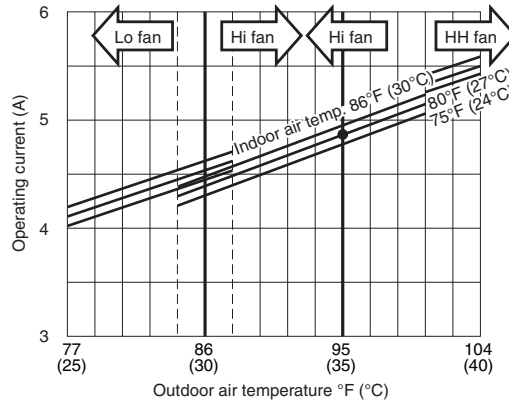

(3) Indoor discharge air performance chart

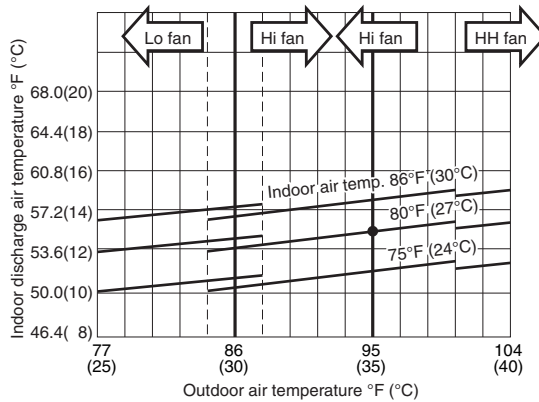

NOTE

- This performance chart shows operation of a single wall-mounted indoor unit. The performance chart will vary depending on the indoor unit type.
- Check each performance value in test-run mode. Electrical performance values represent a combined indoor/outdoor value. (In this case, be sure to stop all the indoor units where performance is not being checked.)
- The performance is for a tubing length of 24.6ft (7.5m). If the tubing length is different, the performance chart will vary.

Outdoor Unit **CU-4KS31NBU** Indoor Unit **CS-MKS18NKU × 1**

■ **Cooling Characteristics**

(RH : 46%, Indoor fan speed : High fan)
(230V, 60Hz)

(1) Low pressure performance chart

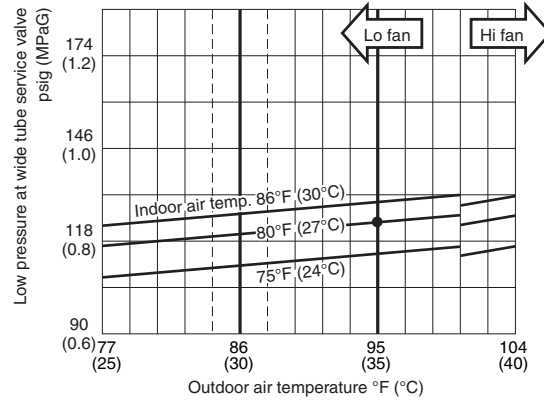

(2) Operating current performance chart

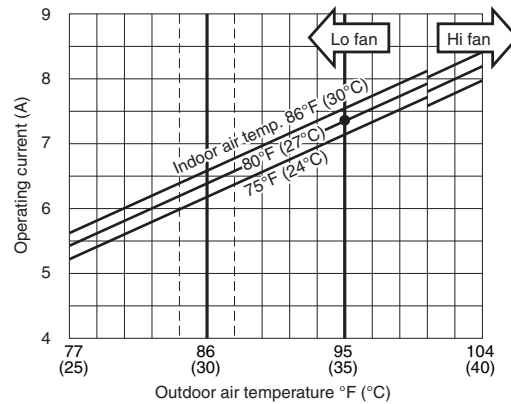

(3) Indoor discharge air performance chart

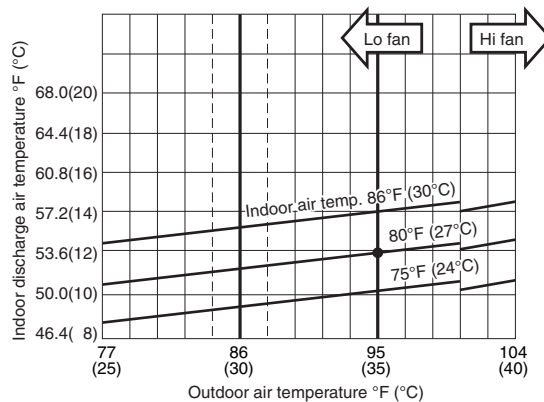

NOTE

- This performance chart shows operation of a single wall-mounted indoor unit. The performance chart will vary depending on the indoor unit type.
- Check each performance value in test-run mode. Electrical performance values represent a combined indoor/outdoor value. (In this case, be sure to stop all the indoor units where performance is not being checked.)
- The performance is for a tubing length of 24.6ft (7.5m). If the tubing length is different, the performance chart will vary.

Outdoor Unit **CU-4KS31NBU** Indoor Unit **CS-MKS24NKU × 1**

■ Cooling Characteristics

(RH : 46%, Indoor fan speed : High fan)
(230V, 60Hz)

(1) Low pressure performance chart

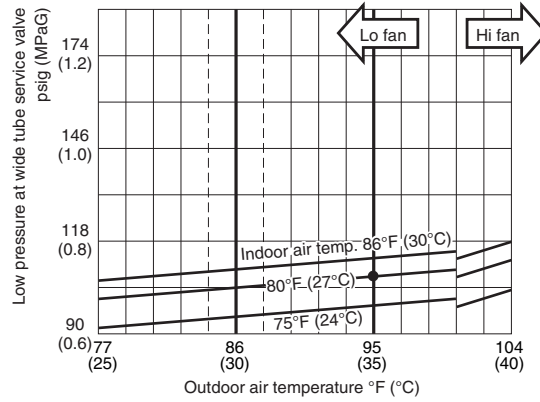

(2) Operating current performance chart

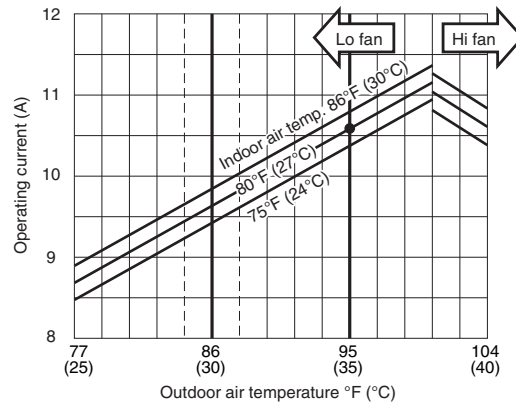

(3) Indoor discharge air performance chart

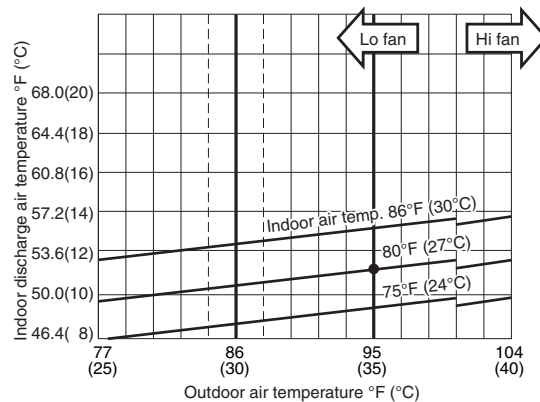

NOTE

- This performance chart shows operation of a single wall-mounted indoor unit. The performance chart will vary depending on the indoor unit type.
- Check each performance value in test-run mode. Electrical performance values represent a combined indoor/outdoor value. (In this case, be sure to stop all the indoor units where performance is not being checked.)
- The performance is for a tubing length of 24.6ft (7.5m). If the tubing length is different, the performance chart will vary.

Outdoor Unit **CU-4KS31NBU** Indoor Unit **CS-MKS9NB4U × 1**

■ Cooling Characteristics

(RH : 46%, Indoor fan speed : High fan)
(230V, 60Hz)

(1) Low pressure performance chart

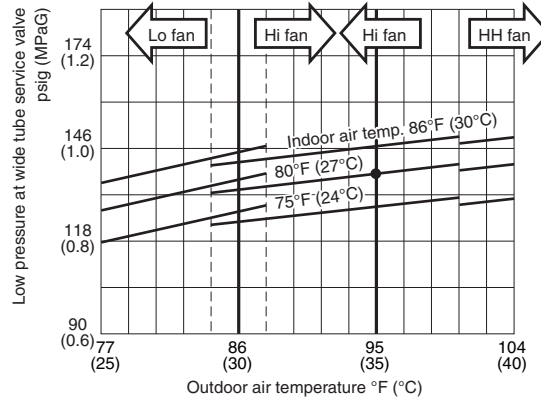

(2) Operating current performance chart

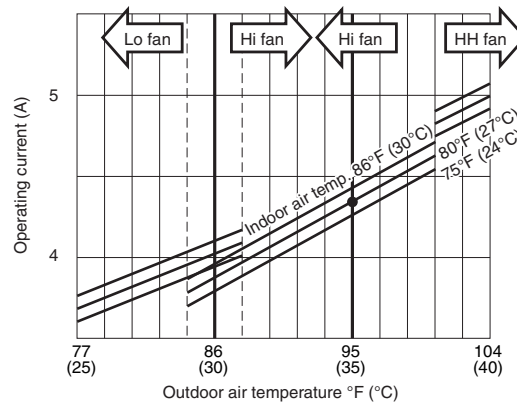

(3) Indoor discharge air performance chart

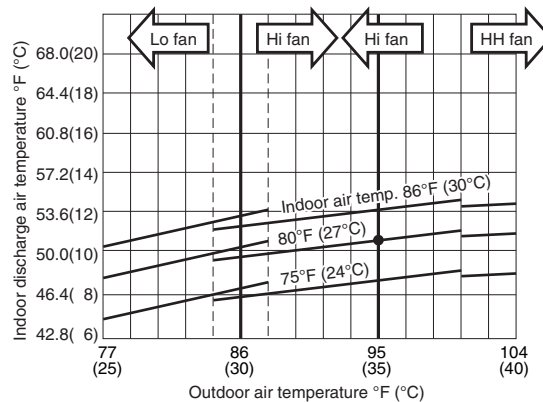

NOTE

- This performance chart shows operation of a single wall-mounted indoor unit. The performance chart will vary depending on the indoor unit type.
- Check each performance value in test-run mode. Electrical performance values represent a combined indoor/outdoor value. (In this case, be sure to stop all the indoor units where performance is not being checked.)
- The performance is for a tubing length of 24.6ft (7.5m). If the tubing length is different, the performance chart will vary.

Outdoor Unit **CU-4KS31NBU** Indoor Unit **CS-MKS12NB4U x 1**

■ **Cooling Characteristics**

(RH : 46%, Indoor fan speed : High fan)
(230V, 60Hz)

(1) Low pressure performance chart

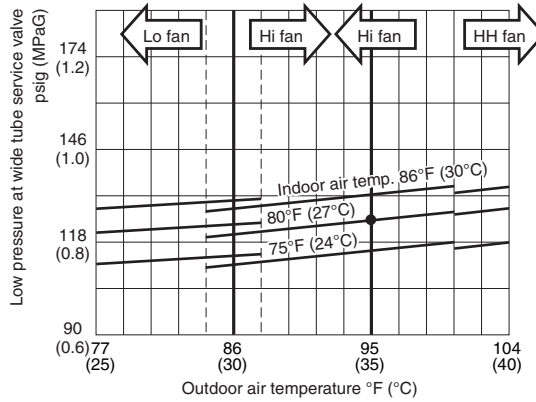

(2) Operating current performance chart

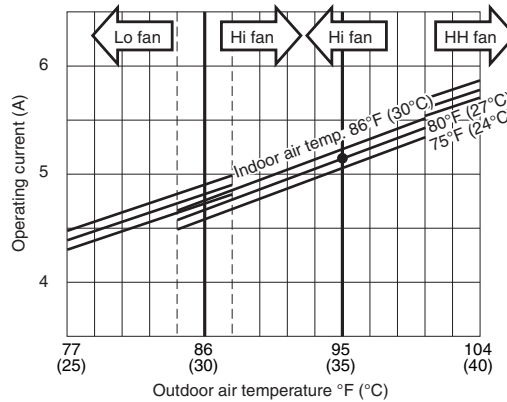

(3) Indoor discharge air performance chart

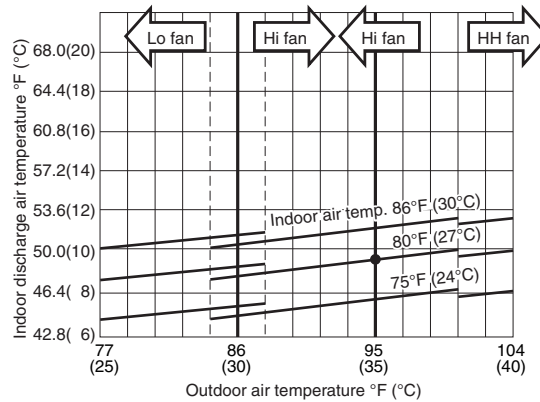

NOTE

- This performance chart shows operation of a single wall-mounted indoor unit. The performance chart will vary depending on the indoor unit type.
- Check each performance value in test-run mode. Electrical performance values represent a combined indoor/outdoor value. (In this case, be sure to stop all the indoor units where performance is not being checked.)
- The performance is for a tubing length of 24.6ft (7.5m). If the tubing length is different, the performance chart will vary.

Outdoor Unit **CU-4KS31NBU** Indoor Unit **CS-KS18NB4UW × 1**

■ Cooling Characteristics

(RH : 46%, Indoor fan speed : High fan)
(230V, 60Hz)

(1) Low pressure performance chart

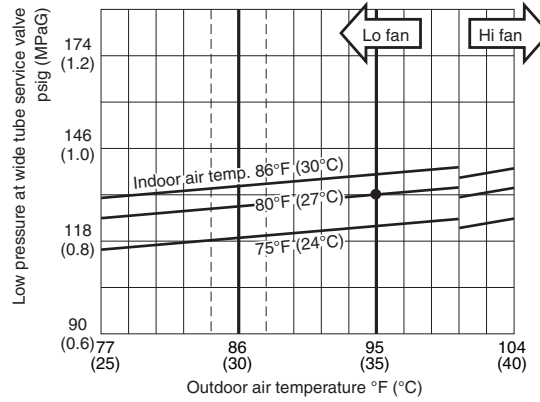

(2) Operating current performance chart

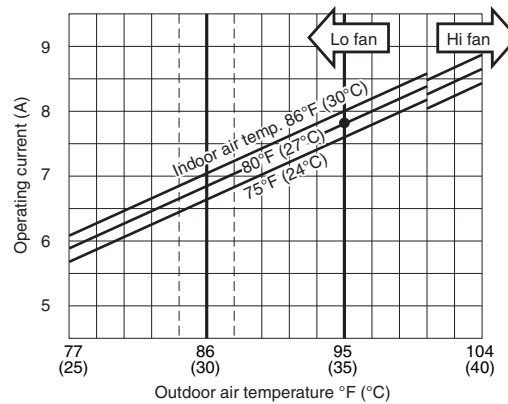

(3) Indoor discharge air performance chart

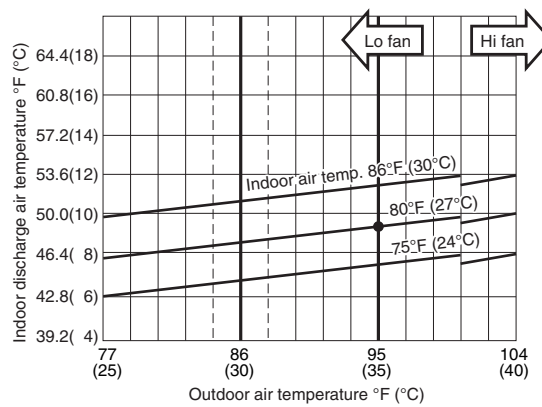

NOTE

- This performance chart shows operation of a single wall-mounted indoor unit. The performance chart will vary depending on the indoor unit type.
- Check each performance value in test-run mode. Electrical performance values represent a combined indoor/outdoor value. (In this case, be sure to stop all the indoor units where performance is not being checked.)
- The performance is for a tubing length of 24.6ft (7.5m). If the tubing length is different, the performance chart will vary.

5-2. Cooling Capacity

Outdoor Unit : **CU-3KS19NBU**

Indoor Unit : **CS-MKS9NKU × 3**

Power Supply : 230V Single Phase 60Hz

< Cooling Capacity >

RATING CAPACITY:		18,800 BTU/h		AIR FLOW RATE:		777 CFM		
INDOOR		OUTDOOR						
ENT. TEMP. °F (°C)		AMBIENT TEMP. °F (°C)						
WB	DB		65 (18.3)	75 (23.9)	85 (29.4)	95 (35.0)	105 (40.6)	115 (46.1)
59 (15.0)		TC	18,880	18,230	17,540	16,990	16,170	15,290
	72 (22.2)	SHC	16,240	15,940	15,630	15,330	15,030	14,580
	76 (24.4)	SHC	18,800	18,230	17,540	16,990	16,170	15,290
	80 (26.7)	SHC	18,880	18,230	17,540	16,990	16,170	15,290
	84 (28.9)	SHC	18,880	18,230	17,540	16,990	16,170	15,290
	88 (31.1)	SHC	18,880	18,230	17,540	16,990	16,170	15,290
63 (17.2)		TC	19,800	19,130	18,420	17,880	17,030	16,120
	72 (22.2)	SHC	13,220	12,920	12,620	12,470	12,010	11,710
	76 (24.4)	SHC	15,940	15,630	15,330	15,030	14,730	14,430
	80 (26.7)	SHC	18,650	18,350	18,050	17,880	17,030	16,120
	84 (28.9)	SHC	19,800	19,130	18,420	17,880	17,030	16,120
	88 (31.1)	SHC	19,800	19,130	18,420	17,880	17,030	16,120
67 (19.4)		TC	20,730	20,050	19,320	# 18,800	17,920	16,970
	72 (22.2)	SHC	10,200	9,900	9,750	9,450	9,150	8,840
	76 (24.4)	SHC	12,920	12,620	12,310	12,160	11,860	11,560
	80 (26.7)	SHC	15,630	15,480	15,180	15,030	14,580	14,280
	84 (28.9)	SHC	18,350	18,050	17,900	17,600	17,290	16,970
	88 (31.1)	SHC	20,730	20,050	19,320	18,800	17,920	16,970
71 (21.7)		TC	21,650	20,970	20,220	19,730	18,830	17,850
	72 (22.2)	SHC	7,030	6,880	6,580	6,430	6,130	5,830
	76 (24.4)	SHC	9,750	9,450	9,300	9,000	8,690	8,390
	80 (26.7)	SHC	12,470	12,310	12,010	11,860	11,560	11,260
	84 (28.9)	SHC	15,180	15,030	14,730	14,580	14,280	13,970
	88 (31.1)	SHC	17,900	17,600	17,440	17,140	16,840	16,540
75 (23.9)		TC	22,470	21,780	21,020	20,570	19,650	18,620
	76 (24.4)	SHC	6,580	6,430	6,280	6,130	5,830	5,530
	80 (26.7)	SHC	9,450	9,300	9,000	8,840	8,540	8,240
	84 (28.9)	SHC	12,160	11,860	11,710	11,560	11,260	10,960
	88 (31.1)	SHC	14,880	14,580	14,430	14,280	13,970	13,670

TC : Total Cooling Capacity (BTU/h) SHC : Sensible Heat Capacity (BTU/h)

NOTE

- Rating conditions (#) : Indoor Unit Entering Air Temp. 80 °F (26.7 °C) DB / 67 °F (19.4 °C) WB
: Outdoor Ambient Temp. 95 °F (35 °C) DB
- Above data does not take Freeze Prevention Protection during cooling operation into account.
For this reason, the value may vary from the actual cooling characteristics.
- Above data represents the value when the operation frequency of a compressor is fixed.

Outdoor Unit : **CU-3KS19NBU**
 Indoor Unit : **CS-MKS12NB4U × 3**
 Power Supply : 230V Single Phase 60Hz

< Cooling Capacity >

RATING CAPACITY:		18,300 BTU/h		AIR FLOW RATE:		706 CFM		
INDOOR		OUTDOOR						
ENT. TEMP. °F (°C)		AMBIENT TEMP. °F (°C)						
WB	DB		65 (18.3)	75 (23.9)	85 (29.4)	95 (35.0)	105 (40.6)	115 (46.1)
59 (15.0)		TC	18,370	17,750	17,080	16,550	15,760	14,900
	72 (22.2)	SHC	15,040	14,770	14,490	14,220	13,940	13,530
	76 (24.4)	SHC	17,370	17,100	16,820	16,550	15,760	14,900
	80 (26.7)	SHC	18,370	17,750	17,080	16,550	15,760	14,900
	84 (28.9)	SHC	18,370	17,750	17,080	16,550	15,760	14,900
	88 (31.1)	SHC	18,370	17,750	17,080	16,550	15,760	14,900
63 (17.2)		TC	19,260	18,620	17,930	17,410	16,590	15,710
	72 (22.2)	SHC	12,430	12,160	11,890	11,610	11,340	10,930
	76 (24.4)	SHC	14,770	14,490	14,220	13,940	13,670	13,260
	80 (26.7)	SHC	17,230	16,960	16,690	16,410	16,140	15,710
	84 (28.9)	SHC	19,260	18,620	17,930	17,410	16,590	15,710
	88 (31.1)	SHC	19,260	18,620	17,930	17,410	16,590	15,710
67 (19.4)		TC	20,150	19,500	18,800	# 18,300	17,450	16,540
	72 (22.2)	SHC	9,830	9,550	9,280	9,140	8,730	8,460
	76 (24.4)	SHC	12,160	11,890	11,610	11,470	11,060	10,790
	80 (26.7)	SHC	14,630	14,350	14,080	13,810	13,530	13,260
	84 (28.9)	SHC	16,960	16,690	16,410	16,270	15,860	15,590
	88 (31.1)	SHC	19,290	19,020	18,740	18,300	17,450	16,540
71 (21.7)		TC	21,050	20,390	19,670	19,200	18,330	17,390
	72 (22.2)	SHC	6,950	6,810	6,540	6,400	5,990	5,710
	76 (24.4)	SHC	9,280	9,140	8,870	8,730	8,320	8,040
	80 (26.7)	SHC	11,750	11,470	11,340	11,060	10,790	10,510
	84 (28.9)	SHC	14,080	13,940	13,670	13,530	13,120	12,850
	88 (31.1)	SHC	16,410	16,270	16,000	15,860	15,450	15,180
75 (23.9)		TC	21,830	21,170	20,440	20,010	19,120	18,040
	76 (24.4)	SHC	6,540	6,400	6,120	5,990	5,710	5,440
	80 (26.7)	SHC	9,000	8,870	8,590	8,460	8,180	7,910
	84 (28.9)	SHC	11,340	11,200	10,930	10,790	10,510	10,240
	88 (31.1)	SHC	13,670	13,530	13,260	13,120	12,850	12,570

TC : Total Cooling Capacity (BTU/h) SHC : Sensible Heat Capacity (BTU/h)

NOTE

- Rating conditions (#) : Indoor Unit Entering Air Temp. 80 °F (26.7 °C) DB / 67 °F (19.4 °C) WB
: Outdoor Ambient Temp. 95 °F (35 °C) DB
- Above data does not take Freeze Prevention Protection during cooling operation into account.
For this reason, the value may vary from the actual cooling characteristics.
- Above data represents the value when the operation frequency of a compressor is fixed.

Outdoor Unit : **CU-4KS24NBU**
 Indoor Unit : **CS-MKS9NKU × 3**
 Power Supply : 230V Single Phase 60Hz

< Cooling Capacity >

RATING CAPACITY:		25,400 BTU/h		AIR FLOW RATE:		777 CFM		
INDOOR		OUTDOOR						
ENT. TEMP. °F (°C)		AMBIENT TEMP. °F (°C)						
WB	DB		65 (18.3)	75 (23.9)	85 (29.4)	95 (35.0)	105 (40.6)	115 (46.1)
59 (15.0)		TC	25,520	24,880	23,960	23,340	18,890	14,000
	72 (22.2)	SHC	19,410	19,100	18,650	18,350	16,240	13,970
	76 (24.4)	SHC	21,970	21,670	21,220	20,910	18,800	14,000
	80 (26.7)	SHC	24,840	24,530	23,960	23,340	18,890	14,000
	84 (28.9)	SHC	25,520	24,880	23,960	23,340	18,890	14,000
	88 (31.1)	SHC	25,520	24,880	23,960	23,340	18,890	14,000
63 (17.2)		TC	26,760	25,900	24,950	24,370	19,290	14,270
	72 (22.2)	SHC	16,240	15,940	15,480	15,180	13,070	10,960
	76 (24.4)	SHC	18,950	18,500	18,200	17,900	15,630	13,670
	80 (26.7)	SHC	21,820	21,370	20,910	20,610	18,500	14,270
	84 (28.9)	SHC	24,380	24,080	23,630	23,330	19,290	14,270
	88 (31.1)	SHC	26,760	25,900	24,950	24,370	19,290	14,270
67 (19.4)		TC	27,750	26,880	25,910	# 25,400	19,630	14,500
	72 (22.2)	SHC	13,070	12,620	12,310	12,010	9,750	7,940
	76 (24.4)	SHC	15,780	15,330	14,880	14,730	12,470	10,660
	80 (26.7)	SHC	18,500	18,200	17,750	17,600	15,330	13,370
	84 (28.9)	SHC	21,220	20,760	20,460	20,160	17,900	14,500
	88 (31.1)	SHC	23,930	23,480	23,180	22,880	19,630	14,500
71 (21.7)		TC	28,690	27,810	26,830	26,400	19,890	14,670
	72 (22.2)	SHC	9,600	9,300	8,840	8,690	6,430	4,770
	76 (24.4)	SHC	12,310	12,010	11,560	11,410	9,150	7,340
	80 (26.7)	SHC	15,030	14,730	14,430	14,280	11,860	10,200
	84 (28.9)	SHC	17,750	17,440	16,990	16,840	14,580	12,920
	88 (31.1)	SHC	20,460	20,160	19,710	19,560	17,290	14,670
75 (23.9)		TC	29,440	28,560	27,580	26,850	20,020	14,760
	76 (24.4)	SHC	9,000	8,690	8,240	8,090	5,830	4,320
	80 (26.7)	SHC	11,710	11,410	11,110	10,810	8,690	7,190
	84 (28.9)	SHC	14,430	14,130	13,820	13,520	11,410	9,750
	88 (31.1)	SHC	17,140	16,840	16,390	16,240	13,970	12,470

TC : Total Cooling Capacity (BTU/h) SHC : Sensible Heat Capacity (BTU/h)

NOTE

- Rating conditions (#) : Indoor Unit Entering Air Temp. 80 °F (26.7 °C) DB / 67 °F (19.4 °C) WB
: Outdoor Ambient Temp. 95 °F (35 °C) DB
- Above data does not take Freeze Prevention Protection during cooling operation into account.
For this reason, the value may vary from the actual cooling characteristics.
- Above data represents the value when the operation frequency of a compressor is fixed.

Outdoor Unit : **CU-4KS24NBU**

Indoor Unit : **CS-KS18NB4UW + CS-MKS12NB4U + CS-MKS12NB4U**

Power Supply : 230V Single Phase 60Hz

< Cooling Capacity >

RATING CAPACITY:		24,800 BTU/h		AIR FLOW RATE:		812 CFM		
INDOOR		OUTDOOR						
ENT. TEMP. °F (°C)		AMBIENT TEMP. °F (°C)						
WB	DB		65 (18.3)	75 (23.9)	85 (29.4)	95 (35.0)	105 (40.6)	115 (46.1)
59 (15.0)		TC	25,120	24,260	23,340	22,720	18,300	13,510
	72 (22.2)	SHC	19,520	19,040	18,570	18,410	16,360	13,510
	76 (24.4)	SHC	22,360	21,880	21,410	21,100	18,300	13,510
	80 (26.7)	SHC	25,120	24,260	23,340	22,720	18,300	13,510
	84 (28.9)	SHC	25,120	24,260	23,340	22,720	18,300	13,510
	88 (31.1)	SHC	25,120	24,260	23,340	22,720	18,300	13,510
63 (17.2)		TC	26,160	25,290	24,340	23,760	18,710	13,790
	72 (22.2)	SHC	16,210	15,890	15,420	15,260	13,050	11,160
	76 (24.4)	SHC	19,040	18,730	18,260	17,940	15,890	13,790
	80 (26.7)	SHC	21,880	21,570	21,100	20,940	18,710	13,790
	84 (28.9)	SHC	24,720	24,410	23,930	23,620	18,710	13,790
	88 (31.1)	SHC	26,160	25,290	24,340	23,760	18,710	13,790
67 (19.4)		TC	27,180	26,290	25,320	# 24,800	19,070	14,020
	72 (22.2)	SHC	12,890	12,580	12,260	11,950	9,740	8,000
	76 (24.4)	SHC	15,730	15,420	14,940	14,790	12,580	10,690
	80 (26.7)	SHC	18,730	18,260	17,940	17,630	15,420	13,680
	84 (28.9)	SHC	21,410	21,100	20,620	20,460	18,260	14,020
	88 (31.1)	SHC	24,250	23,780	23,460	23,300	19,070	14,020
71 (21.7)		TC	28,150	27,250	26,260	25,820	19,350	14,210
	72 (22.2)	SHC	9,420	9,110	8,790	8,630	6,430	4,690
	76 (24.4)	SHC	12,260	11,950	11,470	11,320	9,110	7,530
	80 (26.7)	SHC	15,100	14,790	14,470	14,310	12,100	10,370
	84 (28.9)	SHC	17,940	17,630	17,310	17,150	14,790	13,210
	88 (31.1)	SHC	20,780	20,310	19,990	19,830	17,630	14,210
75 (23.9)		TC	28,950	28,050	27,050	26,320	19,520	14,320
	76 (24.4)	SHC	8,790	8,480	8,160	8,000	5,800	4,380
	80 (26.7)	SHC	11,790	11,470	11,160	10,840	8,790	7,220
	84 (28.9)	SHC	14,470	14,310	13,840	13,680	11,470	10,050
	88 (31.1)	SHC	17,310	16,990	16,680	16,520	14,310	12,740

TC : Total Cooling Capacity (BTU/h) SHC : Sensible Heat Capacity (BTU/h)

NOTE

- Rating conditions (#) : Indoor Unit Entering Air Temp. 80 °F (26.7 °C) DB / 67 °F (19.4 °C) WB
: Outdoor Ambient Temp. 95 °F (35 °C) DB
- Above data does not take Freeze Prevention Protection during cooling operation into account.
For this reason, the value may vary from the actual cooling characteristics.
- Above data represents the value when the operation frequency of a compressor is fixed.

Outdoor Unit : **CU-4KS31NBU**
 Indoor Unit : **CS-MKS9NKU × 4**
 Power Supply : 230V Single Phase 60Hz

< Cooling Capacity >

RATING CAPACITY:		30,600 BTU/h		AIR FLOW RATE:		1,036 CFM		
INDOOR		OUTDOOR						
ENT. TEMP. °F (°C)		AMBIENT TEMP. °F (°C)						
WB	DB		65 (18.3)	75 (23.9)	85 (29.4)	95 (35.0)	105 (40.6)	115 (46.1)
59 (15.0)		TC	30,850	29,770	28,590	27,980	22,750	16,560
	72 (22.2)	SHC	24,260	23,660	23,260	22,860	20,440	16,560
	76 (24.4)	SHC	27,890	27,280	26,680	26,480	22,750	16,560
	80 (26.7)	SHC	30,850	29,770	28,590	27,980	22,750	16,560
	84 (28.9)	SHC	30,850	29,770	28,590	27,980	22,750	16,560
	88 (31.1)	SHC	30,850	29,770	28,590	27,980	22,750	16,560
63 (17.2)		TC	32,150	31,030	29,820	29,290	23,300	16,930
	72 (22.2)	SHC	20,040	19,640	19,030	18,830	16,420	13,800
	76 (24.4)	SHC	23,660	23,260	22,660	22,450	19,840	16,930
	80 (26.7)	SHC	27,480	26,880	26,480	26,080	23,300	16,930
	84 (28.9)	SHC	30,900	30,500	29,820	29,290	23,300	16,930
	88 (31.1)	SHC	32,150	31,030	29,820	29,290	23,300	16,930
67 (19.4)		TC	33,410	32,280	31,030	# 30,600	23,790	17,260
	72 (22.2)	SHC	15,820	15,410	15,010	14,810	12,200	9,780
	76 (24.4)	SHC	19,440	19,030	18,430	18,430	15,820	13,400
	80 (26.7)	SHC	23,260	22,660	22,250	22,050	19,440	17,020
	84 (28.9)	SHC	26,680	26,280	25,870	25,670	23,060	17,260
	88 (31.1)	SHC	30,300	29,900	29,290	29,290	23,790	17,260
71 (21.7)		TC	34,630	33,470	32,190	31,890	24,200	17,520
	72 (22.2)	SHC	11,390	10,990	10,590	10,380	7,770	5,560
	76 (24.4)	SHC	15,010	14,610	14,210	14,010	11,390	9,180
	80 (26.7)	SHC	18,830	18,230	17,830	17,830	15,010	13,000
	84 (28.9)	SHC	22,250	21,850	21,450	21,250	18,630	16,420
	88 (31.1)	SHC	25,870	25,470	25,070	24,870	22,250	17,520
75 (23.9)		TC	35,630	34,460	33,160	33,010	24,460	17,680
	76 (24.4)	SHC	10,790	10,380	9,980	9,780	7,170	5,150
	80 (26.7)	SHC	14,410	14,010	13,600	13,600	10,990	8,980
	84 (28.9)	SHC	18,030	17,630	17,220	17,220	14,410	12,400
	88 (31.1)	SHC	21,650	21,250	20,840	20,640	18,030	16,020

TC : Total Cooling Capacity (BTU/h) SHC : Sensible Heat Capacity (BTU/h)

NOTE

- Rating conditions (#) : Indoor Unit Entering Air Temp. 80 °F (26.7 °C) DB / 67 °F (19.4 °C) WB
 : Outdoor Ambient Temp. 95 °F (35 °C) DB
- Above data does not take Freeze Prevention Protection during cooling operation into account.
 For this reason, the value may vary from the actual cooling characteristics.
- Above data represents the value when the operation frequency of a compressor is fixed.

Outdoor Unit : **CU-4KS31NBU**
 Indoor Unit : **CS-MKS9NB4U × 4**
 Power Supply : 230V Single Phase 60Hz

< Cooling Capacity >

RATING CAPACITY:		28,600 BTU/h		AIR FLOW RATE:		883 CFM		
INDOOR		OUTDOOR						
ENT. TEMP. °F (°C)		AMBIENT TEMP. °F (°C)						
WB	DB		65 (18.3)	75 (23.9)	85 (29.4)	95 (35.0)	105 (40.6)	115 (46.1)
59 (15.0)		TC	28,830	27,880	26,840	26,270	21,300	15,500
	72 (22.2)	SHC	22,560	22,210	21,700	21,360	19,130	15,500
	76 (24.4)	SHC	25,810	25,470	24,960	24,610	21,300	15,500
	80 (26.7)	SHC	28,830	27,880	26,840	26,270	21,300	15,500
	84 (28.9)	SHC	28,830	27,880	26,840	26,270	21,300	15,500
	88 (31.1)	SHC	28,830	27,880	26,840	26,270	21,300	15,500
63 (17.2)		TC	29,960	29,000	27,940	27,440	21,790	15,830
	72 (22.2)	SHC	18,780	18,270	17,930	17,580	15,360	12,960
	76 (24.4)	SHC	22,040	21,700	21,180	21,010	18,610	15,830
	80 (26.7)	SHC	25,470	25,130	24,610	24,440	21,790	15,830
	84 (28.9)	SHC	28,730	28,390	27,870	27,440	21,790	15,830
	88 (31.1)	SHC	29,960	29,000	27,940	27,440	21,790	15,830
67 (19.4)		TC	31,060	30,090	29,010	# 28,600	22,220	16,110
	72 (22.2)	SHC	14,840	14,500	13,980	13,810	11,410	9,180
	76 (24.4)	SHC	18,100	17,760	17,410	17,240	14,670	12,440
	80 (26.7)	SHC	21,530	21,180	20,840	20,670	18,100	15,870
	84 (28.9)	SHC	24,780	24,440	24,100	23,930	21,360	16,110
	88 (31.1)	SHC	28,210	27,700	27,360	27,180	22,220	16,110
71 (21.7)		TC	32,080	31,110	30,020	29,730	22,560	16,340
	72 (22.2)	SHC	10,730	10,380	10,040	9,870	7,470	5,410
	76 (24.4)	SHC	13,980	13,640	13,300	13,130	10,730	8,670
	80 (26.7)	SHC	17,410	17,070	16,730	16,560	14,160	12,100
	84 (28.9)	SHC	20,670	20,330	19,980	19,810	17,410	15,360
	88 (31.1)	SHC	23,930	23,580	23,240	23,240	20,670	16,340
75 (23.9)		TC	32,920	31,940	30,850	30,690	22,770	16,470
	76 (24.4)	SHC	10,040	9,700	9,360	9,360	6,780	4,900
	80 (26.7)	SHC	13,470	13,130	12,780	12,780	10,210	8,330
	84 (28.9)	SHC	16,730	16,380	16,040	16,040	13,470	11,760
	88 (31.1)	SHC	19,980	19,640	19,300	19,300	16,730	15,010

TC : Total Cooling Capacity (BTU/h) SHC : Sensible Heat Capacity (BTU/h)

NOTE

- Rating conditions (#) : Indoor Unit Entering Air Temp. 80 °F (26.7 °C) DB / 67 °F (19.4 °C) WB
 : Outdoor Ambient Temp. 95 °F (35 °C) DB
- Above data does not take Freeze Prevention Protection during cooling operation into account.
 For this reason, the value may vary from the actual cooling characteristics.
- Above data represents the value when the operation frequency of a compressor is fixed.

5-3. Cooling Capacity (Low Ambient)

Outdoor Unit : **CU-3KS19NBU**

Indoor Unit : **CS-MKS9NKU × 3**

Power Supply : 230V Single Phase 60Hz

< Cooling Capacity (Low Ambient) >

RATING CAPACITY:		18,800 BTU/h		AIR FLOW RATE:		777 CFM			
INDOOR		OUTDOOR							
ENT. TEMP. °F (°C)		AMBIENT TEMP. °F (°C)							
WB	DB			15 (-9.4)	25 (-3.9)	35 (1.7)	45 (7.2)	55 (12.8)	
59 (15.0)		TC		19,220	19,090	19,080	19,160	19,010	
	72 (22.2)	SHC		16,390	19,090	16,240	16,390	16,240	
	76 (24.4)	SHC		18,950	19,090	18,950	18,950	18,950	
	80 (26.7)	SHC		19,220	19,090	19,080	19,160	19,010	
	84 (28.9)	SHC		19,220	19,090	19,080	19,160	19,010	
	88 (31.1)	SHC		19,220	19,090	19,080	19,160	19,010	
63 (17.2)		TC		19,620	19,540	19,610	19,780	19,680	
	72 (22.2)	SHC		13,220	19,540	13,070	13,220	13,220	
	76 (24.4)	SHC		15,780	19,540	15,780	15,940	15,780	
	80 (26.7)	SHC		18,650	19,540	18,650	18,650	18,650	
	84 (28.9)	SHC		19,620	19,540	19,610	19,780	19,680	
	88 (31.1)	SHC		19,620	19,540	19,610	19,780	19,680	
67 (19.4)		TC		19,910	19,890	20,060	20,340	20,320	
	72 (22.2)	SHC		9,900	19,890	9,900	10,050	10,050	
	76 (24.4)	SHC		12,620	19,890	12,620	12,770	12,770	
	80 (26.7)	SHC		15,330	19,890	15,480	15,480	15,480	
	84 (28.9)	SHC		18,050	19,890	18,050	18,200	18,200	
	88 (31.1)	SHC		19,910	19,890	20,060	20,340	20,320	
71 (21.7)		TC		20,060	20,120	20,400	20,830	20,890	
	72 (22.2)	SHC		6,430	20,120	6,580	6,730	6,730	
	76 (24.4)	SHC		9,150	20,120	9,300	9,450	9,450	
	80 (26.7)	SHC		12,010	20,120	12,160	12,310	12,310	
	84 (28.9)	SHC		14,580	20,120	14,730	14,880	14,880	
	88 (31.1)	SHC		17,290	20,120	17,440	17,600	17,600	
75 (23.9)		TC		20,040	20,180	20,600	21,180	21,340	
	76 (24.4)	SHC		5,980	20,180	6,130	6,280	6,280	
	80 (26.7)	SHC		8,690	20,180	8,840	9,000	9,150	
	84 (28.9)	SHC		11,410	20,180	11,560	11,710	11,710	
	88 (31.1)	SHC		14,130	20,180	14,280	14,430	14,430	

TC : Total Cooling Capacity (BTU/h) SHC : Sensible Heat Capacity (BTU/h)

NOTE

- Above data does not take Freeze Prevention Protection during cooling operation into account. For this reason, the value may vary from the actual cooling characteristics.
- Above data represents the value when the operation frequency of a compressor is fixed.

Outdoor Unit : **CU-3KS19NBU**
 Indoor Unit : **CS-MKS12NB4U x 3**
 Power Supply : 230V Single Phase 60Hz

< Cooling Capacity (Low Ambient) >

RATING CAPACITY:		18,300 BTU/h		AIR FLOW RATE:		706 CFM			
INDOOR		OUTDOOR							
ENT. TEMP. °F (°C)		AMBIENT TEMP. °F (°C)							
WB	DB			15 (-9.4)	25 (-3.9)	35 (1.7)	45 (7.2)	55 (12.8)	
59 (15.0)		TC		18,680	18,570	18,560	18,620	18,490	
	72 (22.2)	SHC		15,180	18,570	15,180	15,180	15,180	
	76 (24.4)	SHC		17,510	18,570	17,510	17,510	17,510	
	80 (26.7)	SHC		18,680	18,570	18,560	18,620	18,490	
	84 (28.9)	SHC		18,680	18,570	18,560	18,620	18,490	
	88 (31.1)	SHC		18,680	18,570	18,560	18,620	18,490	
63 (17.2)		TC		19,020	18,960	19,030	19,180	19,100	
	72 (22.2)	SHC		12,300	18,960	12,300	12,430	12,430	
	76 (24.4)	SHC		14,630	18,960	14,770	14,770	14,770	
	80 (26.7)	SHC		17,100	18,960	17,100	17,230	17,230	
	84 (28.9)	SHC		19,020	18,960	19,030	19,180	19,100	
	88 (31.1)	SHC		19,020	18,960	19,030	19,180	19,100	
67 (19.4)		TC		19,260	19,260	19,420	19,690	19,670	
	72 (22.2)	SHC		9,420	19,260	9,550	9,690	9,550	
	76 (24.4)	SHC		11,750	19,260	11,890	12,020	12,020	
	80 (26.7)	SHC		14,220	19,260	14,350	14,350	14,350	
	84 (28.9)	SHC		16,550	19,260	16,690	16,690	16,690	
	88 (31.1)	SHC		18,880	19,260	19,020	19,020	19,020	
71 (21.7)		TC		19,360	19,430	19,700	20,110	20,170	
	72 (22.2)	SHC		6,400	19,430	6,540	6,670	6,670	
	76 (24.4)	SHC		8,730	19,430	8,870	9,000	9,000	
	80 (26.7)	SHC		11,200	19,430	11,340	11,470	11,470	
	84 (28.9)	SHC		13,530	19,430	13,670	13,810	13,810	
	88 (31.1)	SHC		15,860	19,430	16,000	16,140	16,140	
75 (23.9)		TC		19,290	19,440	19,840	20,390	20,550	
	76 (24.4)	SHC		5,850	19,440	5,990	6,120	6,120	
	80 (26.7)	SHC		8,180	19,440	8,460	8,590	8,590	
	84 (28.9)	SHC		10,510	19,440	10,790	10,930	10,930	
	88 (31.1)	SHC		12,980	19,440	13,120	13,260	13,260	

TC : Total Cooling Capacity (BTU/h) SHC : Sensible Heat Capacity (BTU/h)

NOTE

1. Above data does not take Freeze Prevention Protection during cooling operation into account. For this reason, the value may vary from the actual cooling characteristics.
2. Above data represents the value when the operation frequency of a compressor is fixed.

Outdoor Unit : **CU-4KS24NBU**
 Indoor Unit : **CS-MKS9NKU × 3**
 Power Supply : 230V Single Phase 60Hz

< Cooling Capacity (Low Ambient) >

RATING CAPACITY:		25,400 BTU/h		AIR FLOW RATE:		777 CFM			
INDOOR		OUTDOOR							
ENT. TEMP. °F (°C)		AMBIENT TEMP. °F (°C)							
WB	DB			15 (-9.4)	25 (-3.9)	35 (1.7)	45 (7.2)	55 (12.8)	
59 (15.0)		TC		25,470	25,420	25,470	25,670	25,610	
	72 (22.2)	SHC		19,250	25,420	19,250	19,410	19,410	
	76 (24.4)	SHC		21,970	25,420	21,970	22,120	22,120	
	80 (26.7)	SHC		24,840	25,420	24,840	24,840	24,840	
	84 (28.9)	SHC		25,470	25,420	25,470	25,670	25,610	
	88 (31.1)	SHC		25,470	25,420	25,470	25,670	25,610	
63 (17.2)		TC		25,540	25,590	25,780	26,160	26,210	
	72 (22.2)	SHC		15,780	25,590	15,780	15,940	16,090	
	76 (24.4)	SHC		18,350	25,590	18,500	18,650	18,650	
	80 (26.7)	SHC		21,220	25,590	21,370	21,520	21,520	
	84 (28.9)	SHC		23,930	25,590	23,930	24,080	24,230	
	88 (31.1)	SHC		25,540	25,590	25,780	26,160	26,210	
67 (19.4)		TC		25,380	25,550	25,930	26,510	26,700	
	72 (22.2)	SHC		12,010	25,550	12,310	12,470	12,620	
	76 (24.4)	SHC		14,730	25,550	15,030	15,180	15,330	
	80 (26.7)	SHC		17,600	25,550	17,750	18,050	18,050	
	84 (28.9)	SHC		20,160	25,550	20,460	20,610	20,760	
	88 (31.1)	SHC		22,880	25,550	23,180	23,330	23,480	
71 (21.7)		TC		24,930	25,240	25,840	26,690	27,040	
	72 (22.2)	SHC		8,240	25,240	8,540	8,840	9,000	
	76 (24.4)	SHC		10,960	25,240	11,260	11,560	11,710	
	80 (26.7)	SHC		13,670	25,240	13,970	14,280	14,430	
	84 (28.9)	SHC		16,390	25,240	16,690	16,990	17,140	
	88 (31.1)	SHC		19,100	25,240	19,410	19,710	19,860	
75 (23.9)		TC		24,210	24,680	25,530	26,670	27,190	
	76 (24.4)	SHC		7,190	24,680	7,640	7,940	8,240	
	80 (26.7)	SHC		10,050	24,680	10,500	10,810	10,960	
	84 (28.9)	SHC		12,620	24,680	13,070	13,520	13,670	
	88 (31.1)	SHC		15,330	24,680	15,780	16,090	16,390	

TC : Total Cooling Capacity (BTU/h) SHC : Sensible Heat Capacity (BTU/h)

NOTE

1. Above data does not take Freeze Prevention Protection during cooling operation into account. For this reason, the value may vary from the actual cooling characteristics.
2. Above data represents the value when the operation frequency of a compressor is fixed.

Outdoor Unit : **CU-4KS24NBU**

Indoor Unit : **CS-KS18NB4UW + CS-MKS12NB4U + CS-MKS12NB4U**

Power Supply : 230V Single Phase 60Hz

< Cooling Capacity (Low Ambient) >

RATING CAPACITY:		24,800 BTU/h		AIR FLOW RATE:		812 CFM			
INDOOR		OUTDOOR							
ENT. TEMP. °F (°C)		AMBIENT TEMP. °F (°C)							
WB	DB			15 (-9.4)	25 (-3.9)	35 (1.7)	45 (7.2)	55 (12.8)	
59 (15.0)		TC		24,890	24,830	24,880	25,090	25,020	
	72 (22.2)	SHC		19,360	24,830	19,360	19,520	19,520	
	76 (24.4)	SHC		22,200	24,830	22,200	22,200	22,200	
	80 (26.7)	SHC		24,890	24,830	24,880	25,090	25,020	
	84 (28.9)	SHC		24,890	24,830	24,880	25,090	25,020	
	88 (31.1)	SHC		24,890	24,830	24,880	25,090	25,020	
63 (17.2)		TC		25,020	25,050	25,250	25,620	25,660	
	72 (22.2)	SHC		15,730	25,050	15,890	16,050	16,050	
	76 (24.4)	SHC		18,570	25,050	18,570	18,730	18,890	
	80 (26.7)	SHC		21,410	25,050	21,570	21,730	21,730	
	84 (28.9)	SHC		24,250	25,050	24,250	24,410	24,570	
	88 (31.1)	SHC		25,020	25,050	25,250	25,620	25,660	
67 (19.4)		TC		24,930	25,080	25,450	26,030	26,200	
	72 (22.2)	SHC		12,100	25,080	12,260	12,420	12,580	
	76 (24.4)	SHC		14,790	25,080	15,100	15,260	15,420	
	80 (26.7)	SHC		17,780	25,080	17,940	18,260	18,260	
	84 (28.9)	SHC		20,460	25,080	20,780	20,940	21,100	
	88 (31.1)	SHC		23,300	25,080	23,460	23,780	23,780	
71 (21.7)		TC		24,560	24,850	25,440	26,280	26,600	
	72 (22.2)	SHC		8,160	24,850	8,480	8,790	8,950	
	76 (24.4)	SHC		11,000	24,850	11,320	11,630	11,630	
	80 (26.7)	SHC		13,840	24,850	14,160	14,470	14,630	
	84 (28.9)	SHC		16,680	24,850	16,990	17,310	17,310	
	88 (31.1)	SHC		19,360	24,850	19,680	19,990	20,150	
75 (23.9)		TC		23,930	24,370	25,200	26,320	26,810	
	76 (24.4)	SHC		7,220	24,370	7,690	8,000	8,160	
	80 (26.7)	SHC		10,050	24,370	10,530	10,840	11,000	
	84 (28.9)	SHC		12,890	24,370	13,370	13,680	13,840	
	88 (31.1)	SHC		15,730	24,370	16,050	16,520	16,680	

TC : Total Cooling Capacity (BTU/h) SHC : Sensible Heat Capacity (BTU/h)

NOTE

1. Above data does not take Freeze Prevention Protection during cooling operation into account. For this reason, the value may vary from the actual cooling characteristics.
2. Above data represents the value when the operation frequency of a compressor is fixed.

Outdoor Unit : **CU-4KS31NBU**
 Indoor Unit : **CS-MKS9NKU × 4**
 Power Supply : 230V Single Phase 60Hz

< Cooling Capacity (Low Ambient) >

RATING CAPACITY:		30,600 BTU/h		AIR FLOW RATE:		1,036 CFM			
INDOOR		OUTDOOR							
ENT. TEMP. °F (°C)		AMBIENT TEMP. °F (°C)							
WB	DB			15 (-9.4)	25 (-3.9)	35 (1.7)	45 (7.2)	55 (12.8)	
59 (15.0)		TC		30,870	30,760	30,800	31,010	30,890	
	72 (22.2)	SHC		24,260	30,760	24,260	24,260	24,260	
	76 (24.4)	SHC		27,890	30,760	27,890	27,890	27,890	
	80 (26.7)	SHC		30,870	30,760	30,800	31,010	30,890	
	84 (28.9)	SHC		30,870	30,760	30,800	31,010	30,890	
	88 (31.1)	SHC		30,870	30,760	30,800	31,010	30,890	
63 (17.2)		TC		31,140	31,130	31,320	31,720	31,730	
	72 (22.2)	SHC		19,640	31,130	19,840	19,840	19,840	
	76 (24.4)	SHC		23,260	31,130	23,260	23,460	23,460	
	80 (26.7)	SHC		26,880	31,130	27,080	27,280	27,280	
	84 (28.9)	SHC		30,500	31,130	30,700	30,700	30,700	
	88 (31.1)	SHC		31,140	31,130	31,320	31,720	31,730	
67 (19.4)		TC		31,150	31,270	31,660	32,300	32,450	
	72 (22.2)	SHC		15,010	31,270	15,210	15,410	15,610	
	76 (24.4)	SHC		18,630	31,270	18,830	19,030	19,030	
	80 (26.7)	SHC		22,250	31,270	22,450	22,860	22,860	
	84 (28.9)	SHC		25,870	31,270	26,080	26,280	26,480	
	88 (31.1)	SHC		29,490	31,270	29,700	29,900	29,900	
71 (21.7)		TC		30,850	31,120	31,750	32,680	33,020	
	72 (22.2)	SHC		10,180	31,120	10,380	10,790	10,790	
	76 (24.4)	SHC		13,600	31,120	14,010	14,410	14,410	
	80 (26.7)	SHC		17,430	31,120	17,630	18,030	18,230	
	84 (28.9)	SHC		21,050	31,120	21,250	21,650	21,650	
	88 (31.1)	SHC		24,470	31,120	24,870	25,270	25,270	
75 (23.9)		TC		30,230	30,670	31,570	32,820	33,340	
	76 (24.4)	SHC		8,980	30,670	9,380	9,780	9,980	
	80 (26.7)	SHC		12,600	30,670	13,200	13,600	13,600	
	84 (28.9)	SHC		16,220	30,670	16,620	17,020	17,220	
	88 (31.1)	SHC		19,840	30,670	20,240	20,640	20,840	

TC : Total Cooling Capacity (BTU/h) SHC : Sensible Heat Capacity (BTU/h)

NOTE

- Above data does not take Freeze Prevention Protection during cooling operation into account. For this reason, the value may vary from the actual cooling characteristics.
- Above data represents the value when the operation frequency of a compressor is fixed.

Outdoor Unit : **CU-4KS31NBU**
 Indoor Unit : **CS-MKS9NB4U x 4**
 Power Supply : 230V Single Phase 60Hz

< Cooling Capacity (Low Ambient) >

RATING CAPACITY:		28,600 BTU/h		AIR FLOW RATE:		883 CFM			
INDOOR		OUTDOOR							
ENT. TEMP. °F (°C)		AMBIENT TEMP. °F (°C)							
WB	DB			15 (-9.4)	25 (-3.9)	35 (1.7)	45 (7.2)	55 (12.8)	
59 (15.0)		TC		28,890	28,790	28,810	28,990	28,870	
	72 (22.2)	SHC		22,560	28,790	22,560	22,730	22,560	
	76 (24.4)	SHC		25,980	28,790	25,810	25,980	25,980	
	80 (26.7)	SHC		28,890	28,790	28,810	28,990	28,870	
	84 (28.9)	SHC		28,890	28,790	28,810	28,990	28,870	
	88 (31.1)	SHC		28,890	28,790	28,810	28,990	28,870	
63 (17.2)		TC		29,170	29,150	29,320	29,660	29,650	
	72 (22.2)	SHC		18,440	29,150	18,440	18,610	18,610	
	76 (24.4)	SHC		21,700	29,150	21,700	21,870	21,870	
	80 (26.7)	SHC		25,130	29,150	25,130	25,300	25,300	
	84 (28.9)	SHC		28,390	29,150	28,390	28,560	28,560	
	88 (31.1)	SHC		29,170	29,150	29,320	29,660	29,650	
67 (19.4)		TC		29,210	29,310	29,650	30,210	30,330	
	72 (22.2)	SHC		14,160	29,310	14,330	14,500	14,500	
	76 (24.4)	SHC		17,410	29,310	17,580	17,760	17,930	
	80 (26.7)	SHC		20,840	29,310	21,010	21,180	21,360	
	84 (28.9)	SHC		24,100	29,310	24,270	24,440	24,610	
	88 (31.1)	SHC		27,360	29,310	27,530	27,870	27,870	
71 (21.7)		TC		28,970	29,200	29,760	30,580	30,860	
	72 (22.2)	SHC		9,700	29,200	9,870	10,210	10,210	
	76 (24.4)	SHC		12,960	29,200	13,130	13,470	13,640	
	80 (26.7)	SHC		16,380	29,200	16,560	16,900	17,070	
	84 (28.9)	SHC		19,640	29,200	19,810	20,160	20,330	
	88 (31.1)	SHC		22,900	29,200	23,240	23,410	23,580	
75 (23.9)		TC		28,440	28,820	29,620	30,720	31,170	
	76 (24.4)	SHC		8,500	28,820	9,010	9,360	9,530	
	80 (26.7)	SHC		11,930	28,820	12,440	12,780	12,960	
	84 (28.9)	SHC		15,360	28,820	15,700	16,040	16,210	
	88 (31.1)	SHC		18,610	28,820	18,960	19,300	19,470	

TC : Total Cooling Capacity (BTU/h) SHC : Sensible Heat Capacity (BTU/h)

NOTE

- Above data does not take Freeze Prevention Protection during cooling operation into account. For this reason, the value may vary from the actual cooling characteristics.
- Above data represents the value when the operation frequency of a compressor is fixed.

6. ELECTRICAL DATA

6-1. Electric Wiring Diagrams

Outdoor Unit CU-3KS19NBU

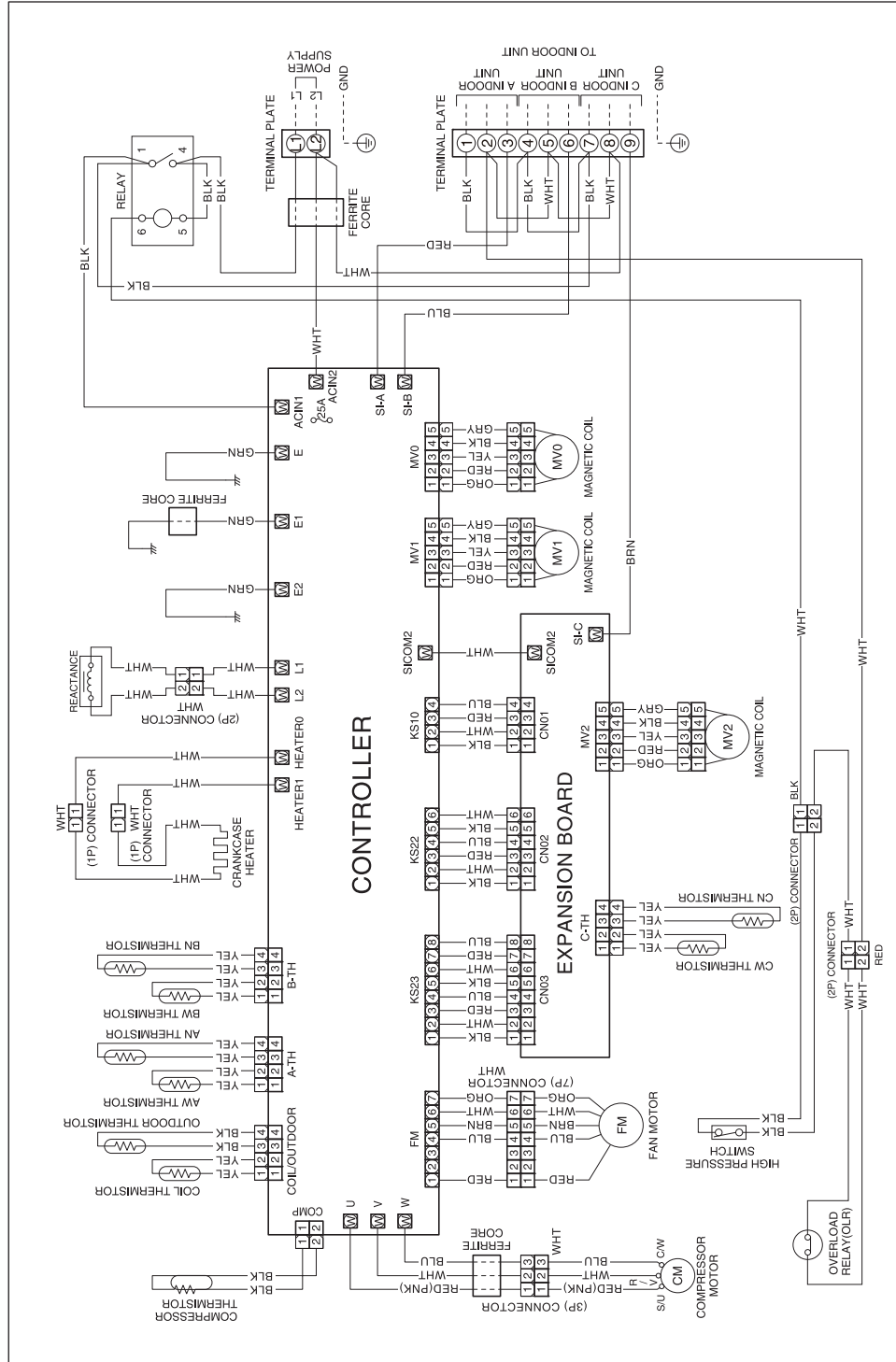

8FA2-5251-11800-1

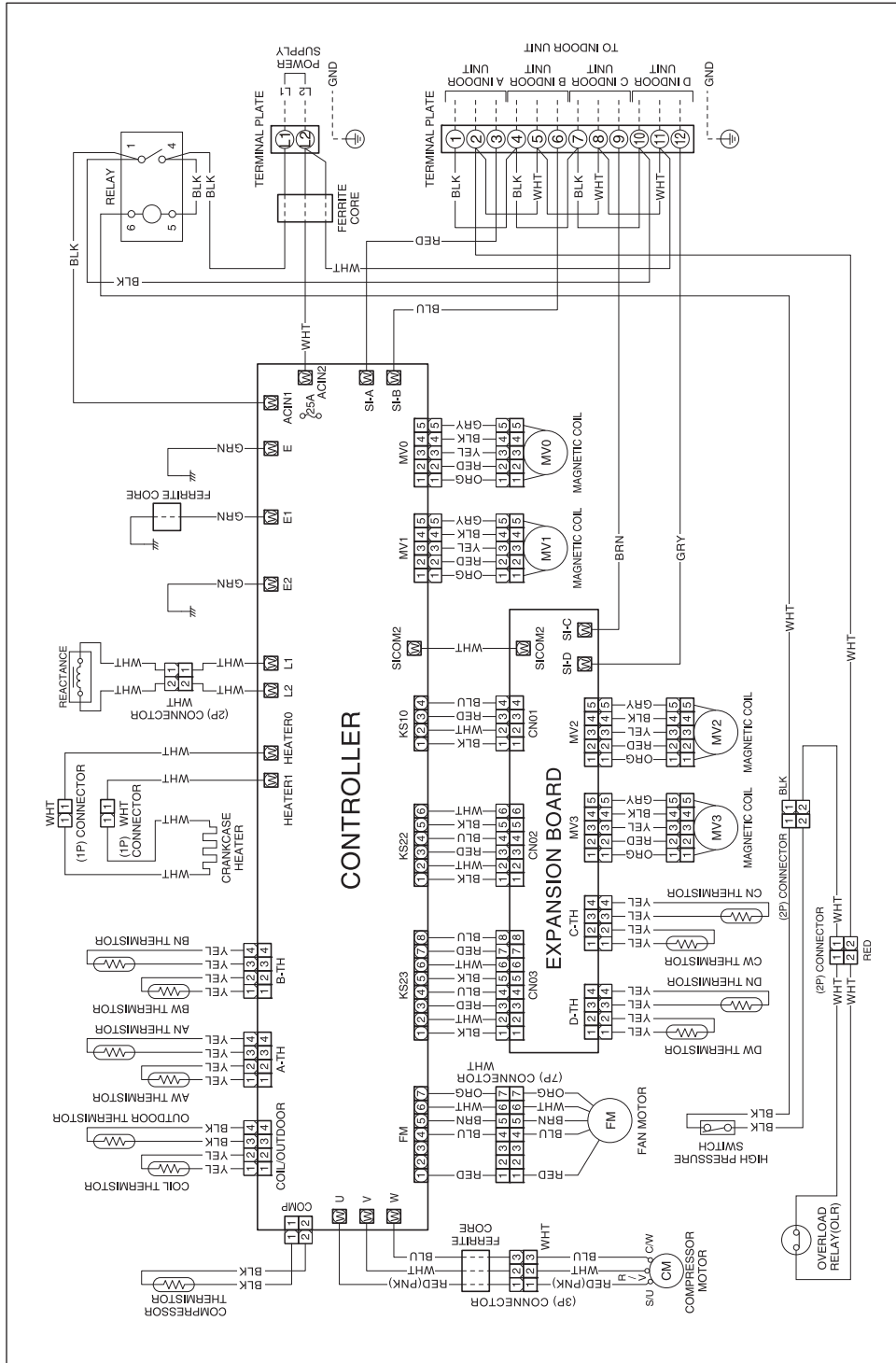

8FA2-5251-11600-1

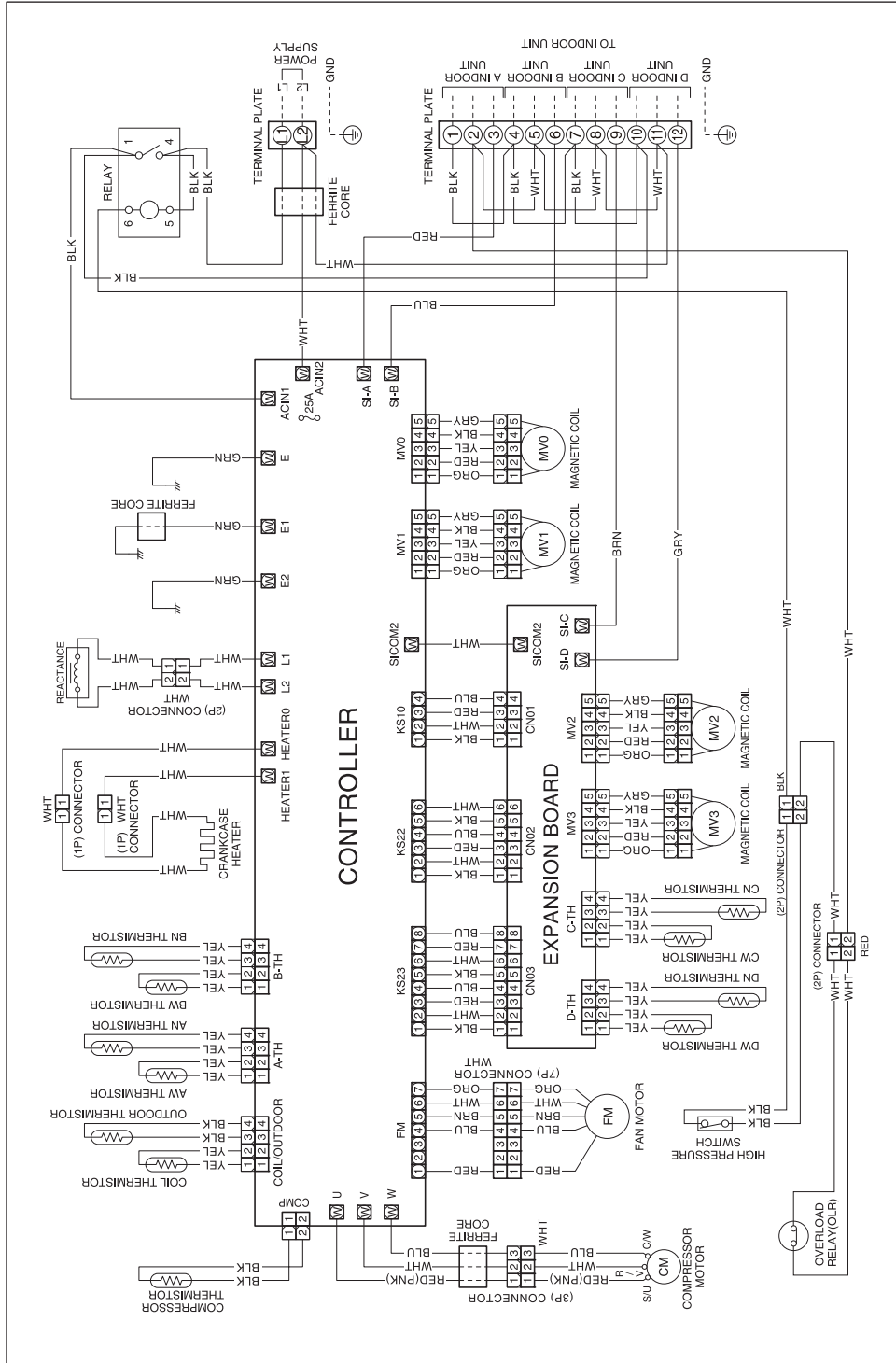

8FA2-5251-11400-1

7. FUNCTIONS

7-1. Explanation of Functions

NOTE The numerical values such as temperature, frequency, time and current in parentheses are an example of CU-4KS31NBU and the values are different from the other models.

	Control/conditions	Unit operation	Explanation
INITIAL	Breaker is ON.	_____	Power is supplied to the indoor and outdoor unit control circuits, however the unit remains stopped. Positioning of the outdoor unit electric expansion valve is performed.
	The ON/OFF operation button on the remote controller is pressed.	If automatic operation mode has been selected with the remote controller, operation begins in SENSOR DRY, or COOL mode depending on the room temperature and outdoor temperature at the time operation starts.	<ul style="list-style-type: none"> ● This applies in the case of automatic COOL operation.
			Depending on the operational mode, refer to the SENSOR DRY, or COOL item.

	Control/conditions	Unit operation	Explanation
COOL	The ON/OFF operation button on the remote controller is pressed.	<ul style="list-style-type: none"> ● The operation lamp illuminates. ● The indoor fan operates at the set fan speed. ● The outdoor unit stops. 	The outdoor unit does not operate for 3 minutes even after the breaker is turned ON.
		The outdoor unit starts. (Compressor and the outdoor fan start.)	<ul style="list-style-type: none"> ● The frequency is increased at the rate of 0.5 Hz every 1 seconds.
		When the frequency reaches α Hz, frequency increases are stopped for a period of β seconds. (Refer to Table 1.)	This is in order to stabilize the return of oil to the compressor.
		The frequency then increases.	If the indoor and outdoor temperatures are high, the current peak cut-off activates, stopping any increases in frequency.
	The room temperature has reached the desired temperature.	The indoor temperature and the desired temperature are approximately equal.	Operating frequency is stabilized in order to maintain a comfortable environment.
	The thermostat turns OFF.	_____	The outdoor unit stops. (It does not stop if the thermostat for another indoor unit is ON.)
	The thermostat turns ON again.	After the thermostat turns ON again, the outdoor unit will not operate for 3 minutes, even if the room temperature increases above the desired temperature.	After 3 minutes, the outdoor unit begins operating automatically. During these 3 minutes, a pressure balance is achieved, allowing the compressor to start more easily.
	Freeze prevention	<ul style="list-style-type: none"> ● When the temperature of the indoor heat exchanger drops to approximately 35.6 °F or below, the compressor turns OFF, the outdoor fan turns OFF, and the indoor fan continues operating with no changes. <p style="text-align: center;">↓</p> <ul style="list-style-type: none"> ● Approximately 3 minutes later, if the temperature of the indoor heat exchanger is above 46.4 °F, the system returns to its original conditions. 	In order to protect against freezing, the compressor stops temporarily, until the temperature of the indoor heat exchanger has risen.
	Stop	All indicator lamps turn OFF. The indoor and outdoor units stop.	_____
Operation is restarted within 4 hours (only when AUTO mode is selected with the remote controller).	Starts operating in the same operating mode (COOL) and with the same temperature settings as before operation was stopped.	Within 4 hours after operation was stopped, it is assumed that there has been no significant change in the indoor and outdoor temperatures, and the previous conditions (COOL) are stored.	
Operation starts after 4 hours or more have passed.	New operating mode is determined based on the temperature conditions at the time the ON/OFF operation button is pressed.	_____	

Frequency control

α (Hz)	β (seconds)	
	Outdoor air temperature is below 32 °F.	Outdoor air temperature is 32 °F or higher.
(25) Hz	(120) seconds	(60) seconds
(35) Hz	(60) seconds	(30) seconds
(45) Hz	(60) seconds	(30) seconds
(55) Hz	(180) seconds	(90) seconds

Table 1

(1/f fluctuation fan)

	Control/conditions	Unit operation	Explanation
SENSOR DRY	The ON/OFF operation button on the remote controller is pressed.	<ul style="list-style-type: none"> ● The operation lamp illuminates. ● The indoor fan operates at the set fan speed. ● The outdoor unit stops. 	The outdoor unit does not operate for 3 minutes even after the breaker is turned ON.
		The outdoor unit starts. (Compressor and the outdoor fan start.)	<ul style="list-style-type: none"> ● The frequency is increased at the rate of 0.5 Hz every 1 seconds.
		When the frequency reaches α Hz, frequency increases are stopped for a period of β seconds. (Refer to Table 1.)	This is in order to stabilize the return of oil to the compressor.
		The frequency then increases.	If the indoor and outdoor temperatures are high, the current peak cut-off activates, stopping any increases in frequency.
	The room temperature reaches the desired temperature, and there is no need for further cooling.	<ul style="list-style-type: none"> ● DRY operation starts <p>DRY A operation</p> <ul style="list-style-type: none"> ● The indoor fan changes between "Low" and "LL" (very low) over a 6-minute cycle. This is 1/f fluctuation fan operation. (Refer to Fig. 1.) 	Operating frequency is stabilized in order to maintain a comfortable environment. <ul style="list-style-type: none"> ● Operates to effectively dehumidify the air while not excessively reducing the indoor temperature. ● The indoor unit operates at 1/f fluctuation fan operation, at a fan speed that does not cause a chilly feeling.
	The room temperature is 59 °F or higher, and is slightly too cold.	<p>DRY B operation</p> (1) The indoor fan changes between "Low" and "LL" (very low) over a 6-minute cycle. This is 1/f fluctuation fan operation. ↓ (2) After approximately 3 minutes, the compressor turns OFF, the outdoor fan turns OFF, and the indoor fan turns OFF. ↓ (3) After approximately 6 minutes, the conditions return to (1).	The compressor operates on a 3-minutes ON, 6-minutes OFF cycle, to prevent the room temperature from dropping too much.
	The room temperature is below 59 °F.	<ul style="list-style-type: none"> ● Monitoring operation begins. 	When monitoring operation begins, the compressor stops, and the indoor fan operates at "LL" (very low) speed.

● **1/f fluctuation fan**

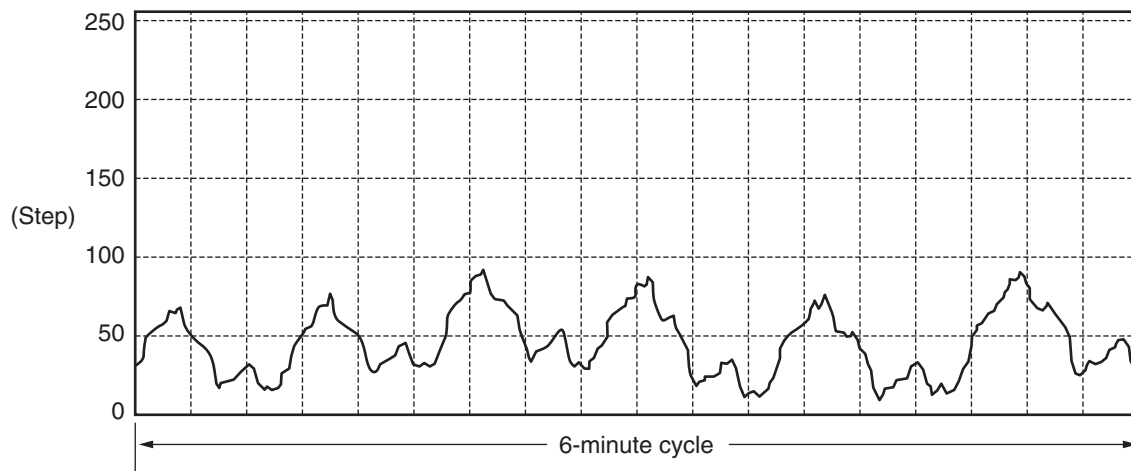
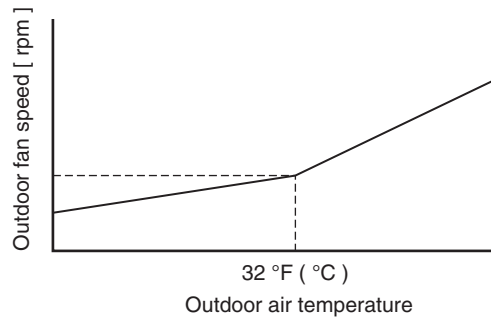

Fig. 1

< Low Ambient Cooling Operation >

- When the outdoor air temperature reaches 57.2 °F (14 °C) or less during the cooling operation, the operation mode is switched to low ambient cooling operation.
- When the mode is switched from cooling operation to low ambient cooling operation, the compressor is stopped for 150 seconds temporarily.
- When the mode has been switched to low ambient cooling operation, the outdoor fan speed is lowered as the outdoor air temperature falls.



- When the outdoor air temperature reaches 62.6 °F (17 °C) or more during the low ambient cooling operation, the operation mode is switched to cooling operation.
- The following protective actions are available to prevent the compressor from operating with abnormal loads.

At that time, they initiate thermo-off (stopping the outdoor unit) of the air conditioner.

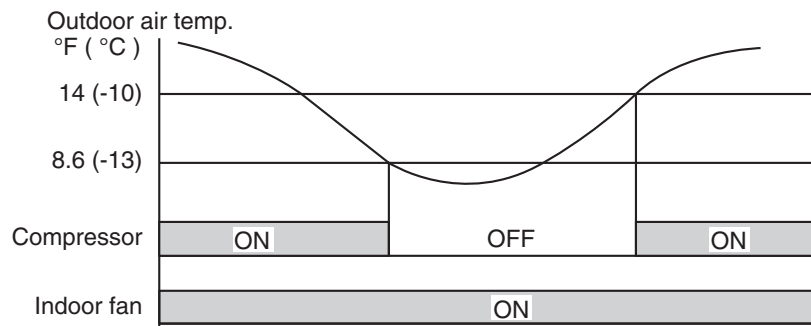

7-2. Protective Functions

NOTE The numerical values such as temperature, frequency, time and current in parentheses are an example of CU-4KS31NBU and the values are different from the other models.

7-2-1. Current Control

- The operating current may rise as a result of causes including increasing cooling loads or decreases in power voltage. In these cases, the operating frequency is automatically reduced, or operation is stopped, in order to control the operating current so that it is (20 A) or less.

As a result: 

- Power breakers and fuses will not be tripped.
- Operation can continue during this period with somewhat reduced cooling capacity.
- Operation at normal capacity is restored when the cause of the current rise is eliminated.

Description of function

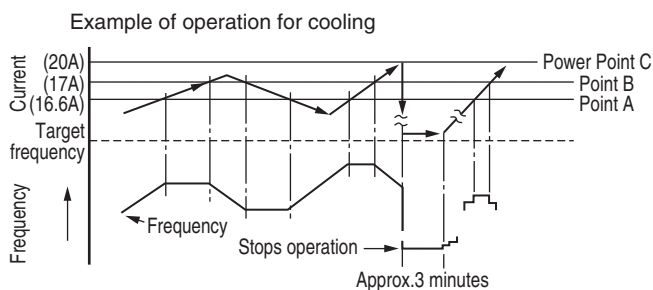

- Operates at the target frequency at Point A and below.
- Stops increases to the frequency between Points A and B.
- Reduces the frequency by 1 Hz per 0.5 seconds when Point B is exceeded.
- Stops operation, and restarts it approximately 3 minutes later, if Point C is exceeded. (May operate when sudden voltage fluctuations occur. → Indicates trouble.)

(1) Automatic frequency control

The operating frequency is reduced automatically, or operation is stopped, in order to control the operating current so that it is at or below the values shown in the table below.

	(20A)
	COOL
Point C (peak cut trip)	(20.0)
Point B (Hz reduction)	(17.0)
Point A (Hz increase prohibit)	(16.6)

(2) Current control

The operating frequency upper limits shown in the figure below are established for frequency reduction and increase-prohibit.

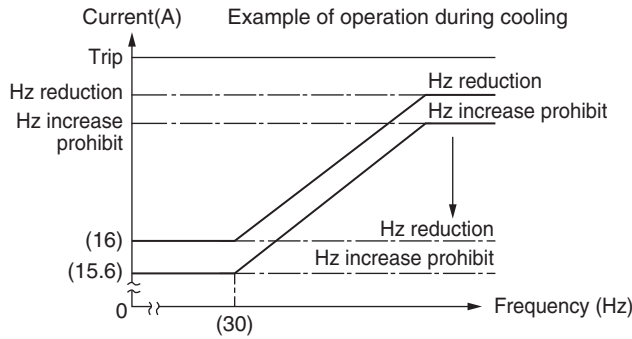

7-2-2. Low Start Current

Operation starts at (8 Hz), and the start current is less than the normal operating current. This prevents the flickering of fluorescent lights or television screens that occurs when ordinary A/C units start.

7-2-3. Compressor Temperature Control

To protect the compressor coil from overheating, the operating frequency is controlled based on the compressor discharge temperature.

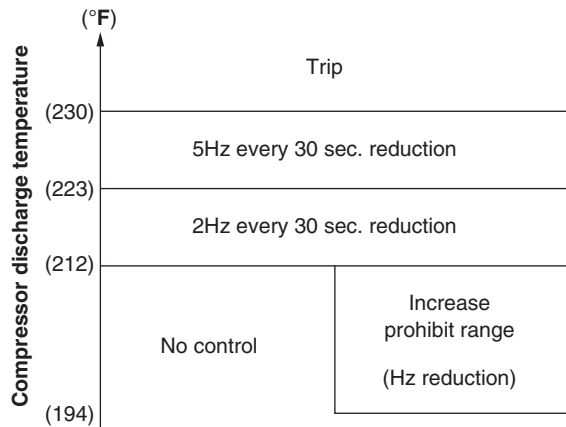

* Within the increase-prohibit range, the range changes to the Hz reduction range (2 Hz every 30 seconds) if the compressor temperature rises by 4 °F.

8. TROUBLESHOOTING (BEFORE CALLING FOR SERVICE)

8-1. Precautions before Performing Inspection or Repair

■ **Both the indoor unit and outdoor unit include electronic control circuits.**

Be sure to pay attention to the following before inspecting or repairing the outdoor-side electronic circuits.

- High-capacity electrolytic capacitors are used inside the outdoor unit controller (inverter). They retain an electrical charge (charging voltage DC 311 V) even after the power is turned OFF, and some time is required for the charge to dissipate.

Be careful not to touch any electrified parts before the control circuit board Power Lamp (red) turns OFF.

If the outdoor control circuit board is normal, approximately 180 seconds will be required for the charge to dissipate. However, allow at least 30 minutes for the charge to dissipate if it is thought there might be trouble with the outdoor control circuit board.

For example, if the outdoor control circuit board fuse has blown, approximately 30 minutes will be required to discharge the high-capacity electrolytic capacitors.

8-2. Trouble Diagnosis by Error Monitor Lamps

	Warning To prevent electric shock, do not inspect or repair until the Power Lamp on the P.C.Board is turned off.	
---	---	---

8-2-1. Location of the Error Monitor Lamps

Remove the top plate of outdoor unit and the cover of Electrical Component Box.

The Power Lamp and Error Monitor Lamps are located on the P.C.Board of Electrical Component Box. (Fig.1)

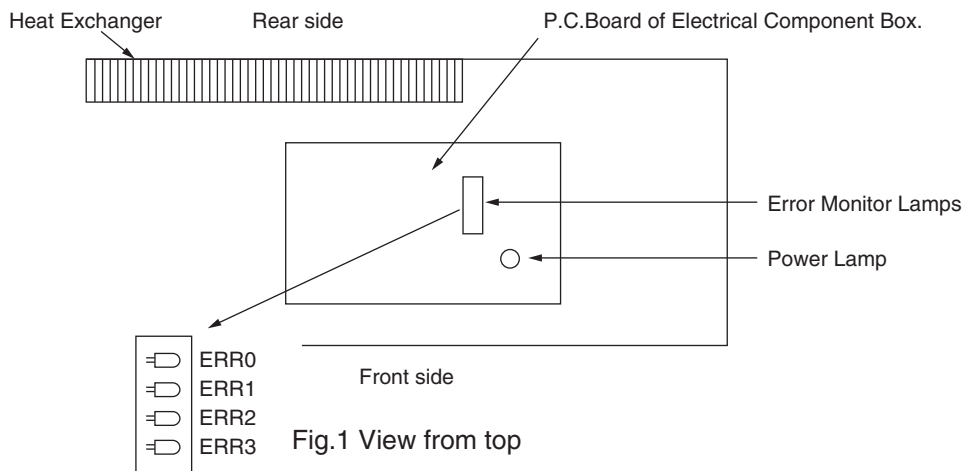

8-2-2. Display of the Error Monitor Lamps

If a protective device has activated or there is a sensor failure in the outdoor unit, the 4 error monitor lamps on the outdoor control circuit board will indicate the nature of the trouble.

○ : ON × : OFF

Error Monitor Lamp				Error Contents
ERR0	ERR1	ERR2	ERR3	
○	×	×	○	Sensor for compressor discharge temp
×	○	×	○	Sensor for heat exchange temp
○	×	×	×	Sensor for branch pipe A (Narrow tube)
×	○	×	×	Sensor for branch pipe B (Narrow tube)
○	○	×	×	Sensor for branch pipe C (Narrow tube)
×	×	○	×	Sensor for branch pipe D (Narrow tube)
○	○	×	○	Outdoor temp sensor
○	×	○	×	Sensor for branch pipe A (Wide tube)
×	○	○	×	Sensor for branch pipe B (Wide tube)
○	○	○	×	Sensor for branch pipe C (Wide tube)
×	×	×	○	Sensor for branch pipe D (Wide tube)
×	×	○	○	HIC circuit trouble (current, temp)
×	○	○	○	Actuation of comp over load relay
○	×	○	○	Actuation of freeze protection function
○	○	○	○	Outdoor unit error. Detail of error message indicate on indoor LED

8-3. Checking the Outdoor System

8-3-1. Checking the outdoor unit

No.	Work procedure	Check items (unit operation)
1	<ul style="list-style-type: none">• Apply 220 V AC between terminals L1 and L2 on the outdoor unit terminal plate.	<ul style="list-style-type: none">• The LED (red) on the control board must illuminate.
2	<ul style="list-style-type: none">• Short-circuit the T-RUN terminal to the COM terminal of TEST/T-RUN terminals.	<ul style="list-style-type: none">• The compressor and fan motor must turn ON. (They turn ON about (70) seconds later after the power is turned ON.)

NOTE If the above check items are okay, but the outdoor unit does not operate, there may be a faulty connection between the indoor unit and the outdoor unit.

8-4. Trouble Diagnosis of Each Part

8-4-1. Problems of Each Part and Inspection Points

- For details about the inspection points, refer to the Inspection Points for Each Part.

Problems Inspection points		Indoor unit				Outdoor unit					Others	No. of Inspection Points for Each part	
		Indoor unit does not operate.	Operation lamp blinking.	Operation lamp does not illuminate.	Indoor fan dose not turn.	Outdoor unit does not operate.	Outdoor fan dose not turn.	The compressor (only) does not operate.	The compressor stops on occasion.	The compressor speed does not increase.	The electric expansion valve does not operate.		Does not cool or cooling performance is inadequate.
Self-Diagnostics check			<input type="radio"/>		<input type="radio"/>	<input type="radio"/>	<input type="radio"/>	<input type="radio"/>					
Indoor unit	Indoor controller (control unit)	<input type="radio"/>	<input type="radio"/>	<input type="radio"/>	<input type="radio"/>	<input type="radio"/>							
	Indoor fan motor		<input type="radio"/>		<input type="radio"/>								
	Room temperature sensor		<input type="radio"/>										
	Heat exchanger temperature sensor		<input type="radio"/>		<input type="radio"/>								
	Inter-unit cable		<input type="radio"/>			<input type="radio"/>	<input type="radio"/>	<input type="radio"/>	<input type="radio"/>	<input type="radio"/>			
	Switch circuit board	<input type="radio"/>		<input type="radio"/>									
Outdoor unit	Outdoor control circuit board		<input type="radio"/>			<input type="radio"/>	<input type="radio"/>	<input type="radio"/>	<input type="radio"/>	<input type="radio"/>			(1)
	Diode module		<input type="radio"/>			<input type="radio"/>							
	HIC		<input type="radio"/>			<input type="radio"/>							
	Electrolytic capacitor		<input type="radio"/>			<input type="radio"/>							
	Fuse		<input type="radio"/>			<input type="radio"/>							(2)
	Compressor		<input type="radio"/>			<input type="radio"/>	<input type="radio"/>	<input type="radio"/>	<input type="radio"/>	<input type="radio"/>			(3)
	Compressor protective sensor		<input type="radio"/>			<input type="radio"/>		<input type="radio"/>	<input type="radio"/>				(4)
	Outdoor fan motor		<input type="radio"/>			<input type="radio"/>	<input type="radio"/>		<input type="radio"/>				
	Coil thermistor		<input type="radio"/>			<input type="radio"/>							(5)
	Electric expansion valve									<input type="radio"/>	<input type="radio"/>		(6)
	Branch tubing temperature sensor		<input type="radio"/>										(7)

		Indoor unit				Outdoor unit					Others	No. of Inspection Points for Each part	
		Indoor unit does not operate.	Operation lamp blinking.	Operation lamp does not illuminate.	Indoor fan dose not turn.	Outdoor unit does not operate.	Outdoor fan dose not turn.	The compressor (only) does not operate.	The compressor stops on occasion.	The compressor speed does not increase.	The electric expansion valve does not operate.		Does not cool or cooling performance is inadequate.
Others	Breaker	<input type="radio"/>				<input type="radio"/>							(8)
	Refrigerant gas pressure							<input type="radio"/>				<input type="radio"/>	(9)

8-4-2. Inspection Points for Each Part

(1) Outdoor control circuit board

Refer to 8-3-1. Checking the outdoor unit.

NOTE Do not remove or insert the outdoor control circuit board connector when power is being supplied to it.
(The controller will be damaged.)

(2) Fuse

Check it visually or the continuity with a tester.

(3) Compressor

Check for an open circuit in the compressor coil winding.

(4) Compressor protective sensor (compressor discharge temperature thermistor)

Check that the sensor is securely contained in the thermostart holder.

(5) Coil thermistor

Check that the sensor is securely contained in the thermostat holder.

(6) Electric expansion valve

- When replacing the electric expansion valve and coil, be sure to attach the connectors in the correct positions. Labels are applied to the valve body and coil, corresponding to the connector colors, to identify them.

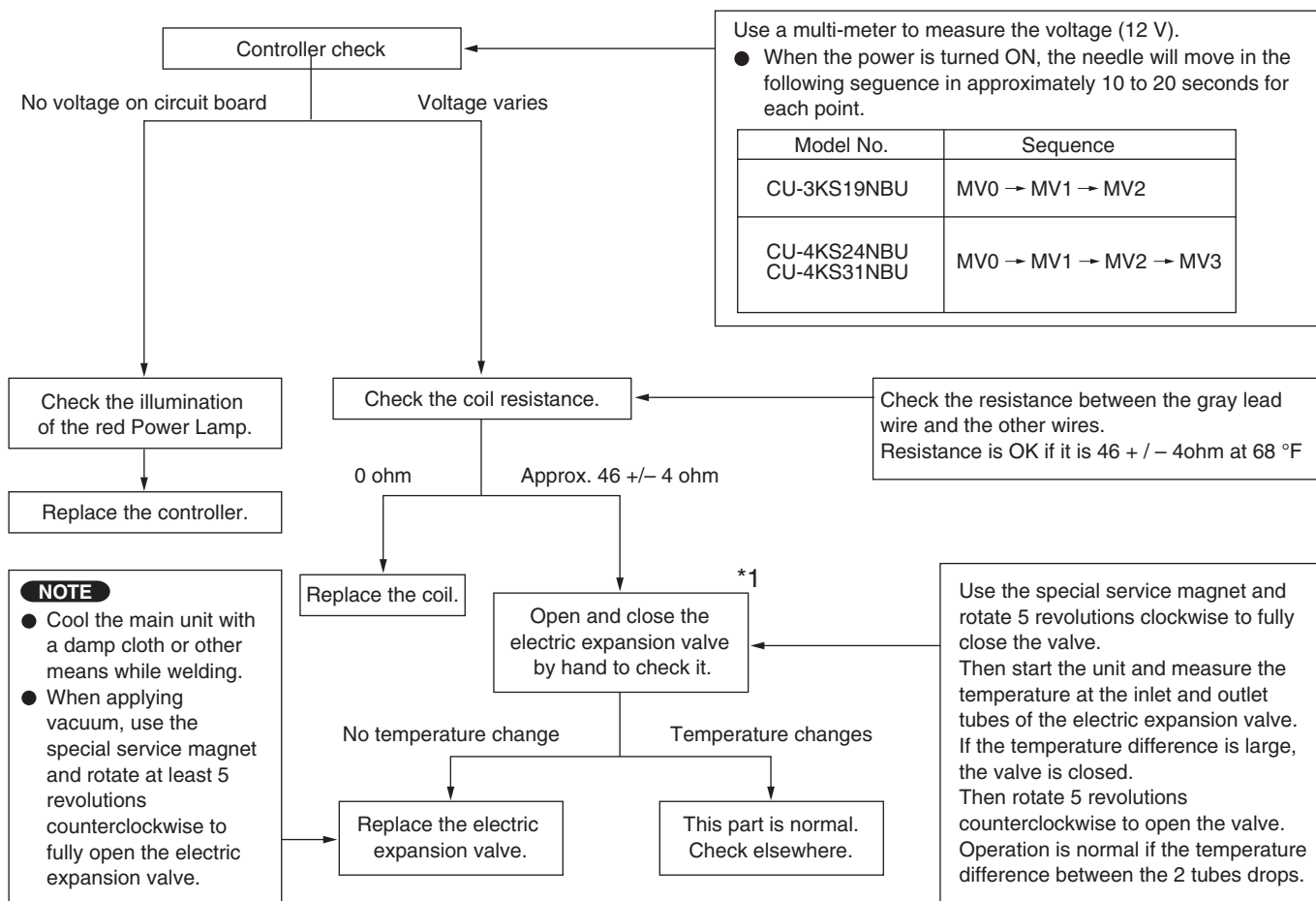

*1 If you have manually checked the electric expansion valve, be sure to reapply the outdoor power after you have replaced the wiring. (The position of the electric expansion valve will change.)

(7) Branch tubing temperature sensor

Check that the sensor is securely contained in the thermostat holder.

(8) Breaker

Check whether or not the breaker has been tripped.

- Check that the breakers and fuses used are of the specified capacity.
- Check that the breaker and its line are exclusive for A/C use.

(9) Refrigerant gas pressure

Start a COOL test run, and measure the temperatures of the A/C intake air and discharge air. Compare the values with the performance charts.

- If the values are higher than the performance charts:

Check for refrigerant shortage or blockage of the refrigerant circuit.

< Assessment of refrigerant shortage >

1. The pressure in the low-pressure section is 5 MPa or more below the value in the performance charts.
2. There is little condensation on the indoor heat exchanger, which overall appears dry.

< Distinguishing between refrigerant shortage and refrigerant circuit blockage >

If the pressure in the low-pressure section does not change when the circuit is charged 2 to 3 times with refrigerant gas (0.44 lbs each time), or if the change is small, then the problem may not be refrigerant shortage.

The problem may be a blockage of the refrigerant circuit.

1. Check that there is no internal leakage inside the 4-way valve:

At the low-pressure side tubing, check that there is no temperature difference between the intake and discharge of the 4-way valve.

2. Check that the electric expansion valve is not blocked. Check as described on the preceding page.

8-5. Trouble Diagnosis of Fan Motor

- This outdoor DC fan motor contains an internal control PCB. Therefore, it is not possible to measure the coil resistance, and the following procedure should be used to check the motor.
- Perform the trouble diagnosis by Test Run mode described on Installation Instructions of indoor unit.

Important: (A) Turn OFF the power before connecting or disconnecting the motor connectors.
 (B) When performing voltage measurement at the outdoor controller connector for (3) in the table below, the DC motor will trip and voltage output will stop approximately 10 seconds after operation is started. For this reason, to measure the voltage again, first turn OFF the outdoor unit power, then, measure the voltage in Test Run mode.

[Trouble symptom 1] The fan does not stop when the outdoor unit stops. →Outdoor unit controller trouble

[Trouble symptom 2] The fan motor does not rotate when the outdoor unit is operating.

(Diagnostic procedure)

* Disconnect the motor connectors and measure the voltage at the DC motor connectors on the outdoor unit controller (3 locations).

Measurement location	Normal value
(1) Vm-Gnd: Between pin 1 and pin 4	DC 230V or more
(2) Vcc-Gnd: Between pin 5 and pin 4	DC 14V or more
(3) Vsp-Gnd: Between pin 7 and pin 4	After fluctuating 4 times between DC 1.7 to 6.1V (1 sec. ON) and DC 0 V (1 sec. OFF), the DC motor trips.

(Diagnostic results)

All of the above measured values are normal. →Fan motor trouble (Replace the motor.)

Any one of the above measured values is not normal. →Outdoor unit controller trouble (Replace the controller .)

(Reference) DC motor connector pin arrangement

- Pin 1: Vm (red)
- Pin 2: Not used
- Pin 3: Not used
- Pin 4: Gnd (blue)
- Pin 5: Vcc (brown)
- Pin 6: PG (white)
- Pin 7: Vsp (orange)

[Trouble symptom 3] Motor rotates for some time (several seconds), but then quickly stops, when the outdoor unit operates.

(There is trouble in the system that provides feedback of motor rotation speed from the motor to the outdoor unit controller.)

[Trouble symptom 4] Fan motor rotation speed does not change during outdoor unit operation.

[Trouble symptom 5] Fan motor rotation speed varies excessively during outdoor unit operation.

(Remedy for symptom 3 to 5)

It is not possible to identify whether the trouble is outdoor unit controller trouble or motor trouble. Therefore, first replace the outdoor unit controller, then (if necessary) replace the DC motor.

9. REFRIGERANT R410A: SPECIAL PRECAUTIONS WHEN SERVICING UNIT

9-1. Characteristics of New Refrigerant R410A

9-1-1. What is New Refrigerant R410A?

R410A is a new refrigerant that contains two types of pseudo-non-azeotropic refrigerant mixture. Its refrigeration capacity and energy efficiency are about the same level as the conventional refrigerant, R22.

9-1-2. Components (mixing proportions)

HFC32 (50%) / HFC125 (50%)

9-1-3. Characteristics

- Less toxic, more chemically stable refrigerant
- The composition of refrigerant R410A changes whether it is in a gaseous phase or liquid phase. Thus, when there is a refrigerant leak the basic performance of the air conditioner may be degraded because of a change in composition of the remaining refrigerant. **Therefore, do not add new refrigerant.** Instead, recover the remaining refrigerant with the refrigerant recovery unit. Then, after evacuation, totally recharge the specified amount of refrigerant with the new refrigerant at its normal mixed composition state (in liquid phase).
- When refrigerant R410A is used, the composition will differ depending on whether it is in gaseous or liquid phase, and the basic performance of the air conditioner will be degraded if it is charged while the refrigerant is in gaseous state. **Thus, always charge the refrigerant while it is in liquid phase.**



CAUTION

Ether-type oil is used for compressor oil for R410A-type units, which is different from the mineral oil used for R22. Thus more attention to moisture prevention and faster replacement work compared with conventional models are required.

9-2. Checklist before Servicing

Use a clutch-type flare tool for R410A or the conventional flare tool. Note that sizes of the resultant flares differ between these two tools. Where a conventional flare tool is used, make sure to observe A Specification (amount of extrusion) by using the flare spacer.

Diameter of tube D	Specification A	
	Flare tool for R410A	Conventional flare tool (for R22)
Dia.1/4" (6.35 mm)	0 to 0.0196" (0 to 0.5 mm)	0.0472" (1.2 mm)
Dia.3/8" (9.52 mm)		
Dia.1/2" (12.7 mm)		
Dia.5/8" (15.88 mm)		

● Size of flare

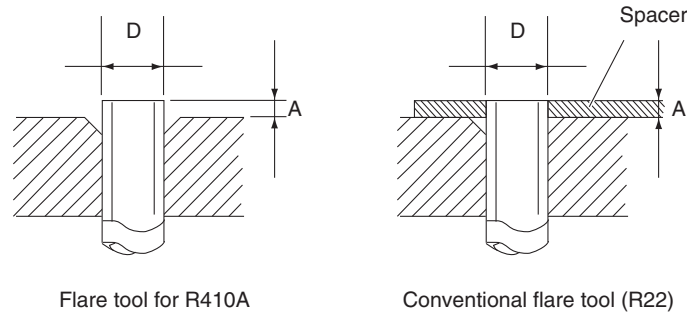

● Tubing precautions

- Refrigerant R410A is more easily affected by dust or moisture compared with R22, thus be sure to temporarily cover the ends of the tubing with caps or tape prior to installation.

Never use 0.0276" (0.7 mm)-thick copper tubing or tubing which is less than 0.0315" (0.8 mm) in thickness, since air conditioners with R410A are subject to higher pressure than those using R22 and R407C.

● No addition of compressor oil for R410A

No additional charge of compressor oil is permitted.

● No use of refrigerant other than R410A

Never use a refrigerant other than R410A.

● If refrigerant R410A is exposed to fire

Through welding, etc., toxic gas may be released when R410A refrigerant is exposed to fire. Therefore, be sure to provide ample ventilation during installation work.

● Caution in case of R410A leak

Check for possible leak points with the special leak detector for R410A. If a leak occurs inside the room, immediately provide thorough ventilation.

9-3. Tools Specifically for R410A

- For servicing, use the following tools for R410A

Tool Distinction	Tool Name
Tools specifically for R410A	<ul style="list-style-type: none"> ● Gauge manifold ● Charging hose ● Gas leak detector ● Refrigerant cylinder ● Charging cylinder ● Refrigerant recovery unit ● Vacuum pump with anti-reverse flow (*1) (Solenoid valve-installed type, which prevents oil from flowing back into the unit when the power is off, is recommended.) ● Vacuum pump (*2)...can be used if the following adapter is attached. ● Vacuum pump adapter (reverse-flow prevention adapter) (*3). (Solenoid valve-installed adapter attached to a conventional vacuum pump.) ● Electronic scale for charging refrigerant ● Flare tool
Tools which can be commonly used for R22, R407C, and R410A	<ul style="list-style-type: none"> ● Bender ● Torque wrench ● Cutter, reamer ● Welding tool, nitrogen gas cylinder



CAUTION

- The above tools specifically for R410A must not be used for R22 and R407C. Doing so will cause malfunction of the unit.
- For the above vacuum pump (*1, *2) and vacuum pump adapter (*3), those for R22-type units can be used for R410A-type. However, they must be used exclusively for R410A and never alternately with R22 and R407C.

- To prevent other refrigerants (R22, R407C) from being mistakenly charged to this unit, shape and external diameter of the service port screw has been altered.

<External diameter of service port> R410A : 5/16"
R22, R407C : 1/4"

9-4. Tubing Installation Procedures

When the tubes are connected, **always apply HAB oil on the flare portions to improve the sealing of tubing.**

The following is the **HAB oil** generally used:

Esso: ZERICE S32

NOTE

For details on tubing installation procedures, refer to the installation manuals attached to the indoor unit and outdoor unit.

9-5. In Case of Compressor Malfunction



CAUTION

- Should the compressor malfunction, be sure to make the switch to a replacement compressor as quickly as possible.
- Use only the tools indicated exclusively for R410A. → See "9-3. Tools Specifically for R410A."

9-5-1. Procedure for Replacing Compressor

(1) Recovering refrigerant

- Any remaining refrigerant inside the unit should not be released to the atmosphere, but recovered using the refrigerant recovery unit for R410A.
- Do not reuse the recovered refrigerant, since it will contain impurities.

(2) Replacing Compressor

- Soon after removing seals of both discharge and suction tubes of the new compressor, replace it quickly.

(3) Checking for sealing

- Use nitrogen gas for the pressurized gas, and never use a refrigerant other than R410A. Also do not use oxygen or any flammable gas.

(4) Evacuation

- **Use a solenoid valve-installed vacuum pump** so that even if power is cut off in the middle of evacuation of air due to a power interruption, the valve will prevent the pump oil from flowing back.
- The equipment may be damaged if moisture remains in the tubing, thus carry out the evacuation thoroughly.
- When using a vacuum pump with exhaust air volume more than 0.883 cu.ft./min. and ultimate vacuum pressure rate of 50 micron Hg.

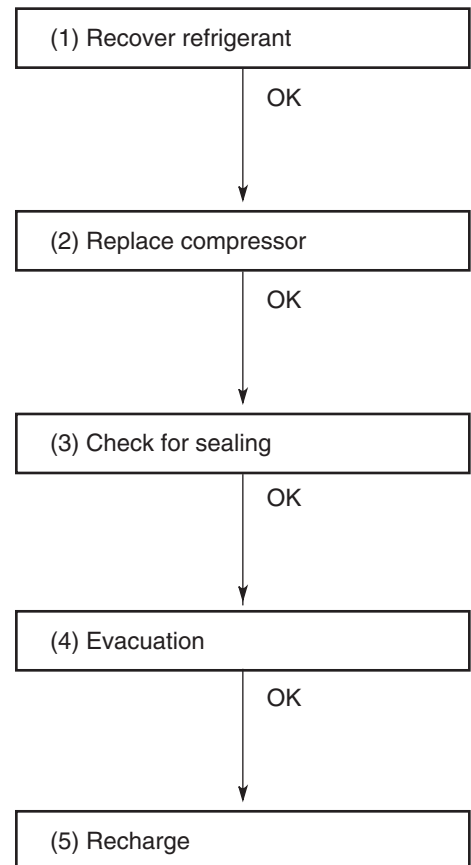

Standard time for evacuation

Length of tubing	Less than 33 ft. (10 m)	More than 33 ft. (10 m)
Evacuation time	More than 10 minutes	More than 15 minutes

(5) Recharging

- **Be sure to charge the specified amount of refrigerant in liquid state** using the service port of the wide tube service valve. The proper amount is listed on the unit's nameplate.

When the entire amount cannot be charged all at once, charge gradually while operating the unit in Cooling Operation.



CAUTION

Never charge a large amount of liquid refrigerant at once to the unit. This may cause damage to the compressor.

- When charging with a refrigerant cylinder, use an electronic scale for charging refrigerant. In this case, if the volume of refrigerant in the cylinder becomes less than 20% of the fully-charged amount, the composition of the refrigerant starts to change. Thus, **do not use the refrigerant if the amount in the charging cylinder is less than 20%.**

Also, charge the minimum necessary amount to the charging cylinder before using it to charge the air conditioning unit.

Example:

In case of charging refrigerant to a unit requiring 1.68 lb. (0.76 Kg) using a capacity of a 22 lb. (10 Kg) cylinder, the minimum necessary amount for the cylinder is:

$$1.68 + 22 \times 0.20 = 6.08 \text{ lb.}$$

$$(0.76 + 10 \times 0.20 = 2.76 \text{ Kg})$$

- **For the remaining refrigerant, refer to the instructions of the refrigerant manufacturer.**

If using a charging cylinder, transfer the specified amount of liquid refrigerant from the refrigerant cylinder to the charging cylinder.

Prepare an evacuated charging cylinder beforehand.



CAUTION

- **To prevent the composition of R410A from changing, never bleed the refrigerant gas into the atmosphere while transferring the refrigerant. (Fig. 3)**

Do not use the refrigerant if the amount in the charging cylinder is less than 20%.

Configuration and characteristics of cylinders

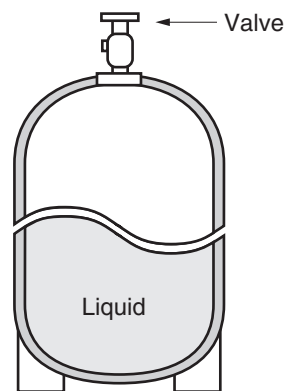

Single valve

Charge liquid refrigerant with cylinder in up-side-down position.

Fig. 1

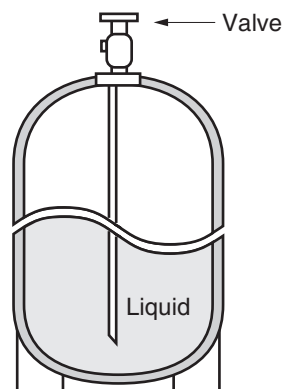

Single valve (with siphon tube)

Charge with cylinder in normal position.

Fig. 2

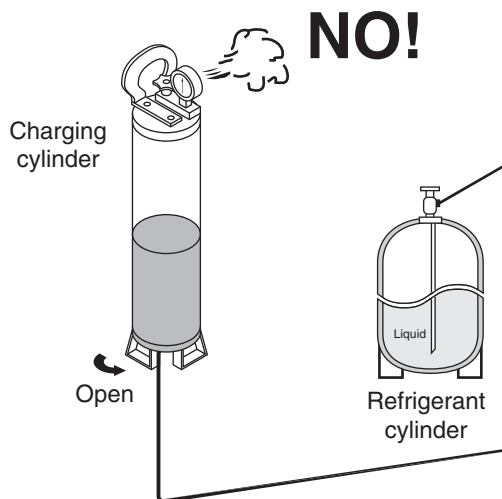

Fig. 3

9-6. In Case Refrigerant is Leaking



CAUTION

Never attempt to charge additional refrigerant when refrigerant has been leaking from the unit. Follow the procedure described below to locate points of leaks and carry out repairs, then recharge the refrigerant.

(1) Detecting Leaks

- Use the detector for R410A to locate refrigerant leak points.

(2) Recovering refrigerant

- Never release the gas to the atmosphere; recover residual refrigerant using the refrigerant recovery unit for R410A, instead.
- Do not reuse the recovered refrigerant because its composition will have been altered.

(3) Welding leaking points

- Confirm again that no residual refrigerant exists in the unit before starting welding.
- Weld securely using flux and wax for R410A.
- Prevent oxide film from forming inside the tubes utilizing substitution with nitrogen (N₂) in the refrigerant circuit of the unit. Leave ends of tubes open during welding.

(4) Checking for sealing

- Use nitrogen gas for the pressurized gas, and never use a refrigerant other than R410A. Also do not use oxygen or any flammable gas.

(5) Evacuation

- **Use a solenoid valve-installed vacuum pump** so that even if power is cut off in the middle of evacuation of air due to a power interruption, the valve will prevent the pump oil from flowing back.
- The equipment may be damaged if moisture remains in the tubing, thus carry out the evacuation thoroughly.
- When using a vacuum pump with exhaust air volume more than 0.883 cu.ft./min. and ultimate vacuum pressure rate of 50 micron Hg.

Standard time for evacuation

Length of tubing	Less than 33 ft. (10 m)	More than 33 ft. (10 m)
Evacuation time	More than 10 minutes	More than 15 minutes

(6) Recharging

- Recharge unit in the same manner explained on the previous page "(5) Recharging."

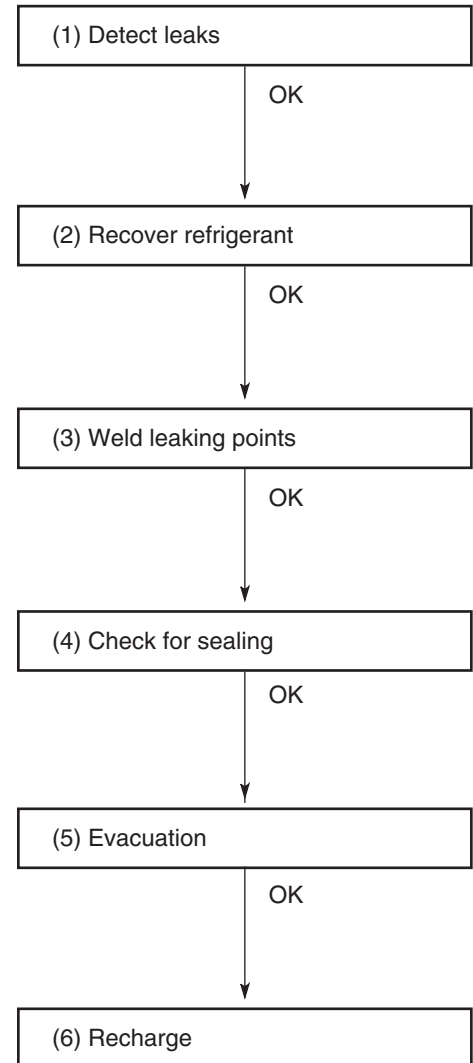

9-7. Charging Additional Refrigerant

9-7-1. When Tubes are Extended

- Observe the proper amount of refrigerant as stated in this service manual or the installation manual that came with the indoor unit. **Charge additional refrigerant in liquid state only.**



CAUTION

Never charge additional refrigerant if refrigerant is leaking from the unit. Follow instructions given in "9-6. In Case Refrigerant is Leaking" and completely carry out repairs. Only then should you recharge the refrigerant.

9-8. Retro-Fitting Existing Systems

9-8-1. Use of Existing Units

- **Never use new refrigerant R410A for existing units which use R22.** This will cause the air conditioner to operate improperly and may result in a hazardous condition.

9-8-2. Use of Existing Tubing

- If replacing an older unit that used refrigerant R22 with a R410A unit, **do not use its existing tubing.** Instead, completely new tubing must be used.

APPENDIX A INSTALLATION INSTRUCTIONS

CU-3KS19NBU
CU-4KS24NBU
CU-4KS31NBU

(852-6-4190-581-00-1)

INSTALLATION INSTRUCTIONS

Split System Air Conditioner

Contents

This air conditioner uses the refrigerant R410A.

NOTE External diameter of service port R410A: 5/16"

IMPORTANT!

Please Read Before Starting 2

Page

Model Combinations

Combine indoor and outdoor units only as listed below.

Model No.

<u>Indoor Unit</u>	<u>Outdoor Unit</u>
CS-MKS7NKH	CU-3KS19NBU
CS-MKS9NKH	CU-4KS24NBU
CS-MKS12NKH	CU-4KS31NBU
CS-MKS18NKH	
CS-MKS24NKH	
CS-MKS9NB4U	
CS-MKS12NB4U	
CS-KS18NB4UW	

Power Source:
60 Hz, single-phase, 230 / 208 VAC

- 1. GENERAL** 4
 - 1-1. Tools Required for Installation (not supplied)
 - 1-2. Accessories Supplied with Unit
 - 1-3. Optional Copper Tubing Kit
 - 1-4. Type of Copper Tube and Insulation Material
 - 1-5. Additional Materials Required for Installation
- 2. INSTALLATION SITE SELECTION** 5
 - 2-1. Indoor Unit
 - 2-2. Connecting Indoor Units
 - 2-3. Outdoor Unit
 - 2-4. Baffle Plate for the Outdoor Unit
 - 2-5. Outer Dimensions of Outdoor Unit
 - 2-6. Diagram of Outdoor Unit Installation
- 3. INSTALLATION PROCESS** 16
 - 3-1. Embedding the Tubing and Wiring
 - 3-2. Use of the Flaring Method
 - 3-3. Flaring Procedure with a Flare Tool
 - 3-4. Caution before Connecting Tubes Tightly
 - 3-5. Tubing Connections
 - 3-6. Insulation of Refrigerant Tubing
 - 3-7. Taping the Tubes
 - 3-8. Finishing the Installation
- 4. AIR PURGING** 19
 - Air Purging with a Vacuum Pump (for Test Run)
 - Pump Down
- 5. WIRING INSTRUCTIONS** 22
 - 5-1. General Precautions on Wiring
 - 5-2. Recommended Wire Length and Diameter
 - 5-3. Wiring System Diagram
 - 5-4. How to Connect Wiring to the Terminal
 - 5-5. Wiring Instructions for the Outdoor Unit
- 6. TEST RUN** 26
- 7. CONNECTING A HOME AUTOMATION DEVICE** 27
- 8. INSTALLATION CHECK SHEET** 27

Combination example

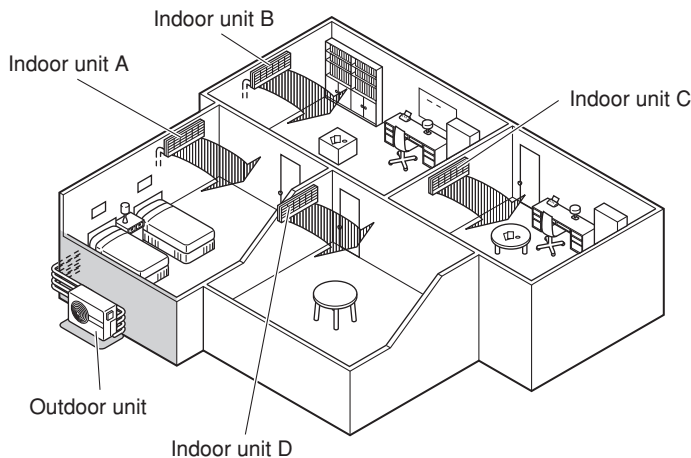

IMPORTANT!

Please Read Before Starting

This air conditioning system meets strict safety and operating standards. As the installer or service person, it is an important part of your job to install or service the system so it operates safely and efficiently.

For safe installation and trouble-free operation, you must:

- Carefully read this instruction booklet before beginning.
- Follow each installation or repair step exactly as shown.
- Observe all local, state, and national electrical codes.
- Pay close attention to all warning and caution notices given in this manual.



WARNING

This symbol refers to a hazard or unsafe practice which can result in severe personal injury or death.



CAUTION

This symbol refers to a hazard or unsafe practice which can result in personal injury or product or property damage.

If Necessary, Get Help

These instructions are all you need for most installation sites and maintenance conditions. If you require help for a special problem, contact our sales/service outlet or your certified dealer for additional instructions.

In Case of Improper Installation

The manufacturer shall in no way be responsible for improper installation or maintenance service, including failure to follow the instructions in this document.

SPECIAL PRECAUTIONS

WARNING When Wiring



ELECTRICAL SHOCK CAN CAUSE SEVERE PERSONAL INJURY OR DEATH. ONLY A QUALIFIED, EXPERIENCED ELECTRICIAN SHOULD ATTEMPT TO WIRE THIS SYSTEM.

- Do not supply power to the unit until all wiring and tubing are completed or reconnected and checked.
- Highly dangerous electrical voltages are used in this system. Carefully refer to the wiring diagram and these instructions when wiring. Improper connections and inadequate grounding can cause **accidental injury or death**.
- **Ground the unit** following local electrical codes.
- Connect all wiring tightly. Loose wiring may cause overheating at connection points and a possible fire hazard.
- To prevent possible hazards from insulation failure,  the unit must be grounded.

When Transporting

Be careful when picking up and moving the indoor and outdoor units. Get a partner to help, and bend your knees when lifting to reduce strain on your back. Sharp edges or thin aluminum fins on the air conditioner can cut your fingers.

When Installing...

Select an installation location which is rigid and strong enough to support or hold the unit, and select a location for easy maintenance.

...In a Ceiling or Wall

Make sure the ceiling/wall is strong enough to hold the unit's weight. It may be necessary to construct a strong wood or metal frame to provide added support.

...In a Room

Properly insulate any tubing run inside a room to prevent "sweating" that can cause dripping and water damage to walls and floors.



CAUTION

Keep the fire alarm and the air outlet at least 1.5 m away from the unit.

...In Moist or Uneven Locations

Use a raised concrete pad or concrete blocks to provide a solid, level foundation for the outdoor unit. This prevents water damage and abnormal vibration.

...In an Area with High Winds

Securely anchor the outdoor unit down with bolts and a metal frame. Provide a suitable air baffle.

...In a Snowy Area

Install the outdoor unit on a raised platform that is higher than drifting snow. Provide snow vents.

When Connecting Refrigerant Tubing



WARNING

- When performing piping work do not mix air except for specified refrigerant (R410A) in refrigeration cycle. It causes capacity down, and risk of explosion and injury due to high tension inside the refrigerant cycle.
- Refrigerant gas leakage may cause fire.
- Do not add or replace refrigerant other than specified type. It may cause product damage, burst and injury etc.
- Ventilate the room well, in the event that refrigerant gas leaks during the installation. Be careful not to allow contact of the refrigerant gas with a flame as this will cause the generation of poisonous gas.

- Use the flare method for connecting tubing.
- Apply refrigerant lubricant to the matching surfaces of the flare and union tubes before connecting them, then tighten the nut with a torque wrench for a leak-free connection.
- Check carefully for leaks before starting the test run.
- Do not leak refrigerant while piping work for an installation or re-installation, and while repairing refrigeration parts. Handle liquid refrigerant carefully as it may cause frost-bite.



When Servicing

- Turn the power OFF at the main power box (mains) before opening the unit to check or repair electrical parts and wiring. 
- Keep your fingers and clothing away from any moving parts.
- Clean up the site after you finish, remembering to check that no metal scraps or bits of wiring have been left inside the unit being serviced.

Others



CAUTION

- Ventilate any enclosed areas when installing or testing the refrigeration system. Escaped refrigerant gas, on contact with fire or heat, can produce dangerously toxic gas.
- Confirm upon completing installation that no refrigerant gas is leaking. If escaped gas comes in contact with a stove, gas water heater, electric room heater or other heat source, it can produce dangerously toxic gas.
- Do not install only a single indoor unit.
- Do not touch the air inlet or the sharp aluminum fins of the outdoor unit. You may get injured. 
- Do not sit or step on the unit, you may fall down accidentally. 
- Do not stick any object into the FAN CASE. You may be injured and the unit may be damaged. 



NOTE

The illustrations are based on the typical appearance of a standard model. Consequently, the shape may differ from that of the air conditioner that you are installing.

1. General





This booklet briefly outlines where and how to install the air conditioning system. Please read over the entire set of instructions for the indoor and outdoor units and make sure all accessory parts listed are with the system before beginning. If the electric wiring diagram does not appear in this manual, please check for the diagram on the indoor unit.

1-1. Tools Required for Installation (not supplied)

- | | | |
|------------------------------|-----------------------|-----------------------------|
| 1. Standard screwdriver | 7. Hacksaw | 13. Torque wrench |
| 2. Phillips head screwdriver | 8. Core bits | 14. Adjustable wrench |
| 3. Knife or wire stripper | 9. Hammer | 15. Reamer (for deburring) |
| 4. Tape measure | 10. Drill | 16. Vacuum pump (For R410A) |
| 5. Carpenter's level | 11. Tube cutter | 17. Manifold valve |
| 6. Sabre saw or key hole saw | 12. Tube flaring tool | |

1-2. Accessories Supplied with Unit

Table 1

Parts	Figure	Q'ty	Parts	Figure	Q'ty	Parts	Figure	Q'ty				
Labels for inter-unit cable and tube		4 each	Cushion rubber		4	Reducer (1/2" x 3/8")		<table border="1"> <tr> <td>CU-4KS24NBU</td> <td>1</td> </tr> <tr> <td>CU-4KS31NBU</td> <td>2</td> </tr> </table>	CU-4KS24NBU	1	CU-4KS31NBU	2
CU-4KS24NBU	1											
CU-4KS31NBU	2											
Reducer (3/8" x 1/2")		CU-3KS19NBU	1	Packed in the outdoor unit.								

1-3. Optional Copper Tubing Kit

Copper tubing for connecting the outdoor unit to the indoor unit is available in kits which contain the narrow and wide tubing, fittings and insulation. Consult your nearest sales outlet or air conditioning workshop.

1-4. Type of Copper Tube and Insulation Material

If you wish to purchase these materials separately from a local source, you will need:

- Deoxidized annealed copper tube for refrigerant tubing as detailed in Table 2.
Cut each tube to the appropriate lengths 1' to 1'4" (30 cm to 40 cm) to dampen vibration between units.

2. Foamed polyethylene insulation for the specified copper tubes as required to precise length of tubing. Wall thickness of the insulation should be not less than 5/16" (8 mm).
3. Use insulated copper wire for field wiring. Wire size varies with the total length of wiring. Refer to 5. Wiring Instructions for details.



CAUTION

Check local electrical codes and regulations before obtaining wire. Also, check any specified instructions or limitations.

Table 2

Model	Narrow Tube		Wide Tube	
	Outer Dia.	Thickness	Outer Dia.	Thickness
CS-MKS7NКУ, CS-MKS9NКУ, CS-MKS12NКУ	1/4" (6.35 mm)	0.0314" (0.8 mm)	3/8" (9.52 mm)	0.0314" (0.8 mm)
CS-MKS18NКУ	1/4" (6.35 mm)	0.0314" (0.8 mm)	1/2" (12.70 mm)	0.0314" (0.8 mm)
CS-MKS24NКУ	1/4" (6.35 mm)	0.0314" (0.8 mm)	5/8" (15.88 mm)	0.0393" (1.0 mm)
CS-MKS9NB4U, CS-MKS12NB4U	1/4" (6.35 mm)	0.0314" (0.8 mm)	3/8" (9.52 mm)	0.0314" (0.8 mm)
CS-KS18NB4UW	1/4" (6.35 mm)	0.0314" (0.8 mm)	1/2" (12.70 mm)	0.0314" (0.8 mm)

1-5. Additional Materials Required for Installation

1. Refrigeration (armored) tape
2. Insulated staples or clamps for connecting wire (See local codes.)
3. Putty
4. Refrigeration lubricant
5. Clamps or saddles to secure refrigerant tubing

2. Installation Site Selection

2-1. Indoor Unit



WARNING

To prevent abnormal heat generation and the possibility of fire, do not place obstacles, enclosures and grilles in front of or surrounding the air conditioner in a way that may block air flow.

AVOID:

- direct sunlight.
- nearby heat sources that may affect performance of the unit.
- areas where leakage of flammable gas may be expected.
- placing or allowing any obstructions near the air conditioner inlet or outlet.
- installing in rooms that contain instant-on (rapid-start) fluorescent lamps. (These may prevent the air conditioner from receiving signals.)
- places where large amounts of oil mist exist.
- installing in locations where there are devices that generate high-frequency emissions.

DO:

- select an appropriate position from which every corner of the room can be uniformly air-conditioned. (High on a wall is best for wall-mounted types.)
- select a location that will hold the weight of the unit.
- select a location where tubing and drain hose have the shortest run to the outside. (Fig. 1)
- allow room for operation and maintenance as well as unrestricted air flow around the unit. (Fig. 2a or 2b)
- install the unit within the maximum elevation difference (H1, H2, H3, H4) above or below the outdoor unit and within a total tubing length (L1+L2+L3, L1+L2+L3+L4) from the outdoor unit as detailed in Table 3 and Fig. 3a.

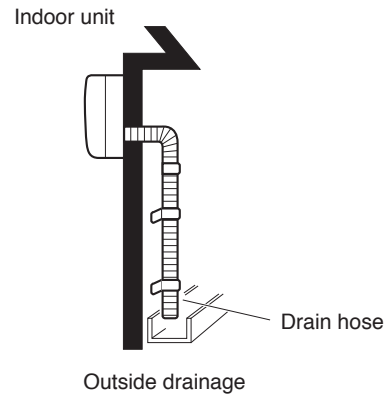
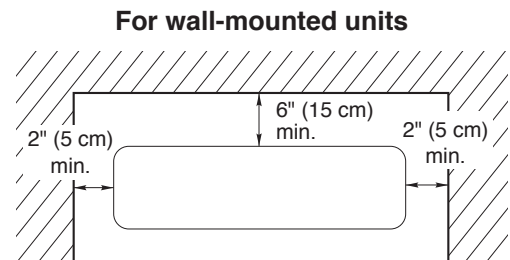

Fig. 1



Front View

Fig. 2a

For ceiling-mounted cassette units

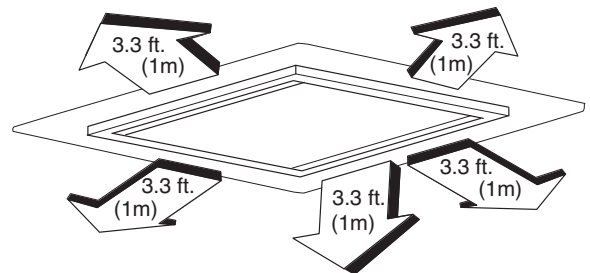

Fig. 2b



CAUTION

- Air delivery from a ceiling-mounted cassette unit will be degraded if the distance from the floor to the ceiling is greater than 10 ft. (3 m).
- For stable operation of the air conditioner, do not install wall-mounted units less than 5' (1.5 m) from floor level. (Fig. 3b)

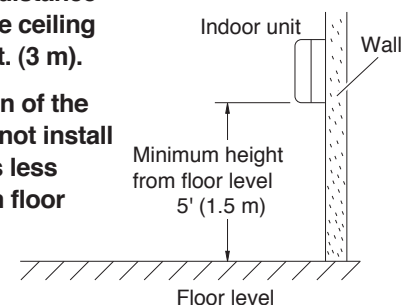

Fig. 3b

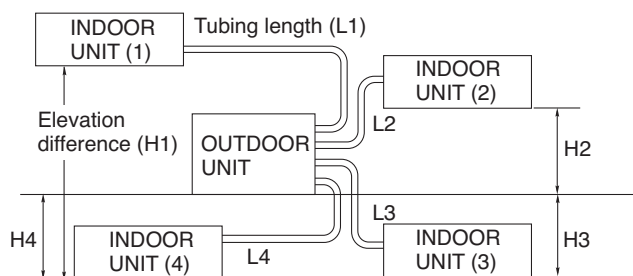

Fig. 3a

- install the indoor unit more than 3.3' (1 m) away from any antenna or power lines or connecting wires used for television, radio, telephone, security system, or intercom. Electrical noise from any of these sources may affect operation.
- install in a sturdy manner to avoid increased operating noise.

Table 3

Model	Max. Allowable Tubing Length Per Unit (ft.)	Max. Allowable Total Tubing Length at Shipment (L1+L2+L3) or (L1+L2+L3+L4) (ft.)	Limit of Total Tubing Length (L1+L2+L3) or (L1+L2+L3+L4) (ft.)	Limit of Elevation Difference (H1, H2, H3, H4) (ft.)	Required Amount of Additional Refrigerant (oz./ft.)*
CU-3KS19NBU	82	150 (L1+L2+L3)	150 (L1+L2+L3)	50	—
CU-4KS24NBU	82	150 (L1+L2+L3+L4)	200 (L1+L2+L3+L4)	50	0.22
CU-4KS31NBU	100	150 (L1+L2+L3+L4)	230 (L1+L2+L3+L4)	50	0.22

* If total tubing length becomes 150 to 200 ft. (Max.) or 150 to 230 ft. (Max.), charge additional refrigerant (R410A) by 0.22 oz./ft. No additional charge of compressor oil is necessary. For more detailed charging information, refer to the Technical & Service Manual.

2-2. Connecting Indoor Units

Figures (4a) – (4k) show the different types of indoor unit connections, including the use of a reducer. To select the required indoor unit to be connected, refer to the Combination Table that was included in the outdoor unit package.

(1) Connecting indoor unit for CU-3KS19NBU

(A)

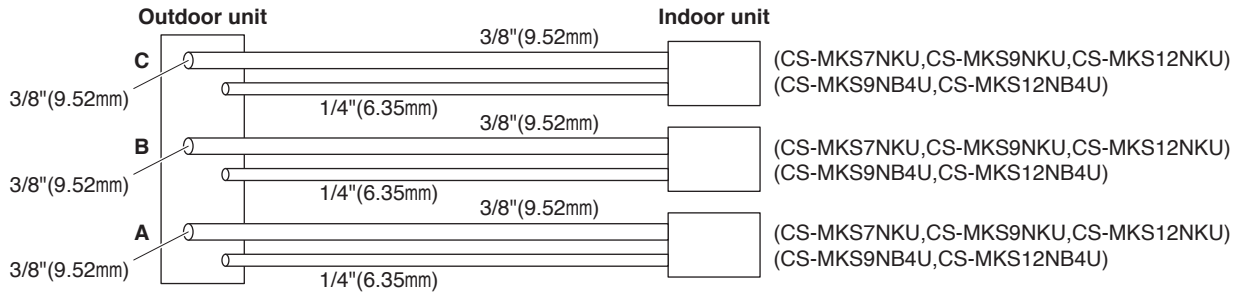

Fig. 4a

(B)

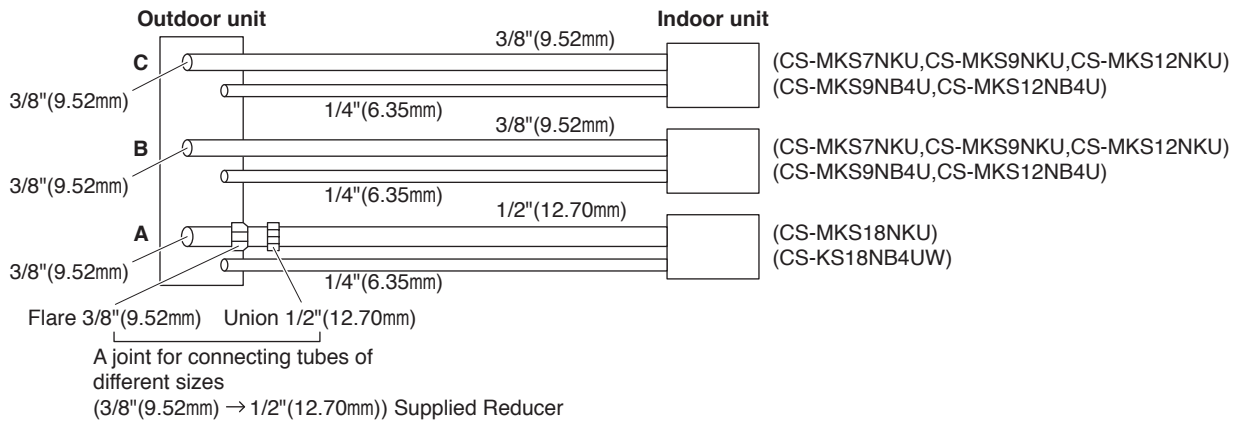

Fig. 4b

(2) Connecting indoor unit for CU-4KS24NBU

(A)

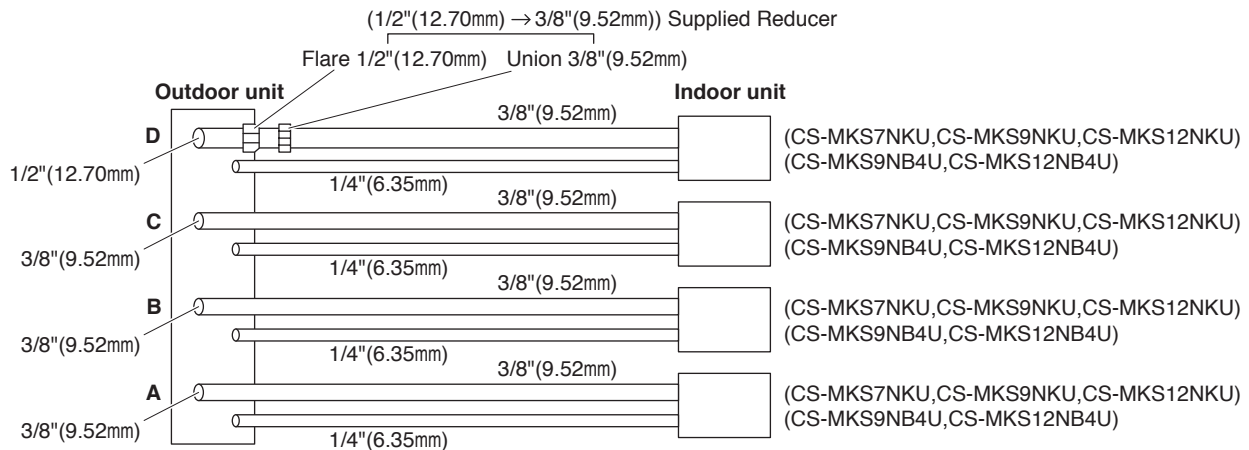

Fig. 4c

(3) Connecting indoor unit for CU-4KS31NBU

(A)

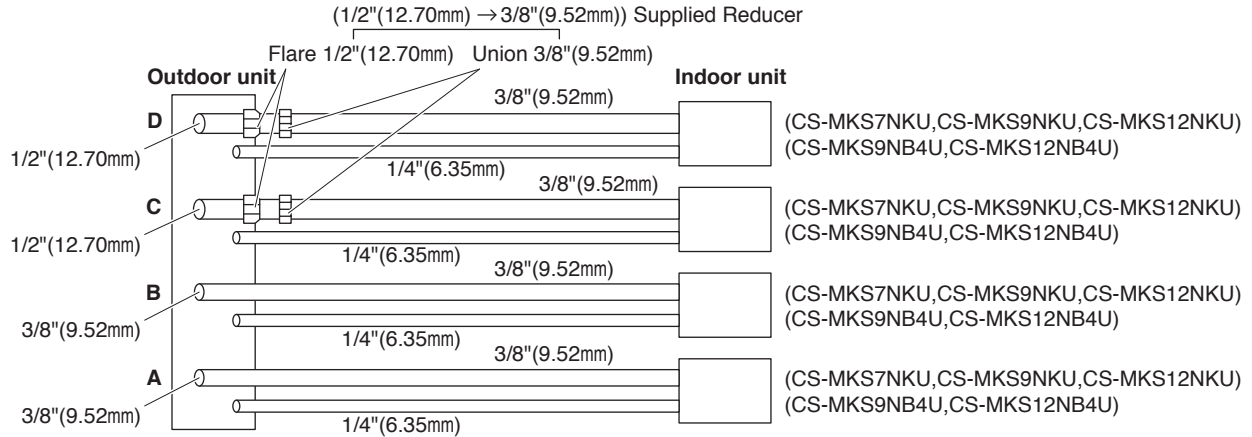

Fig. 4g

(B)

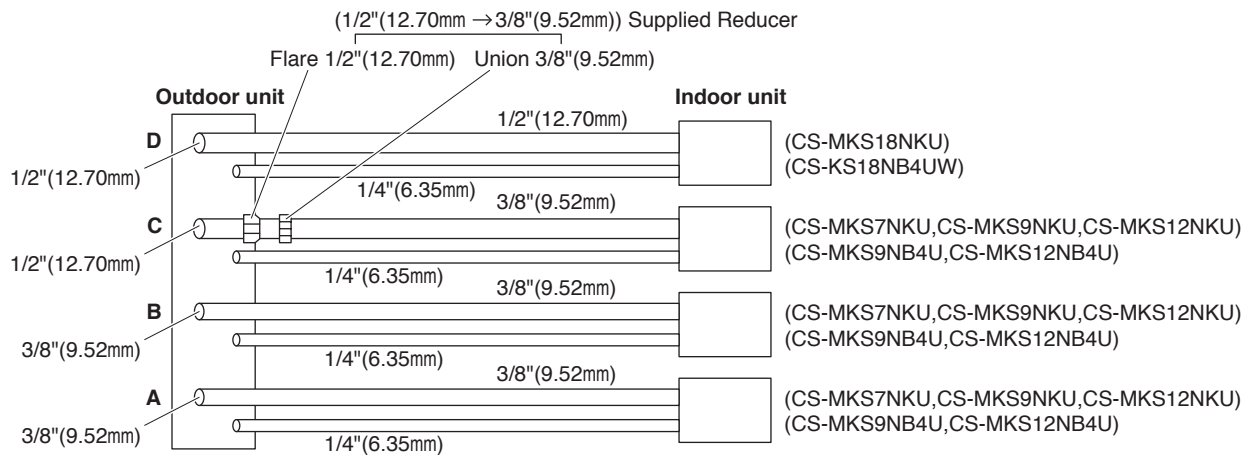

Fig. 4h

(C)

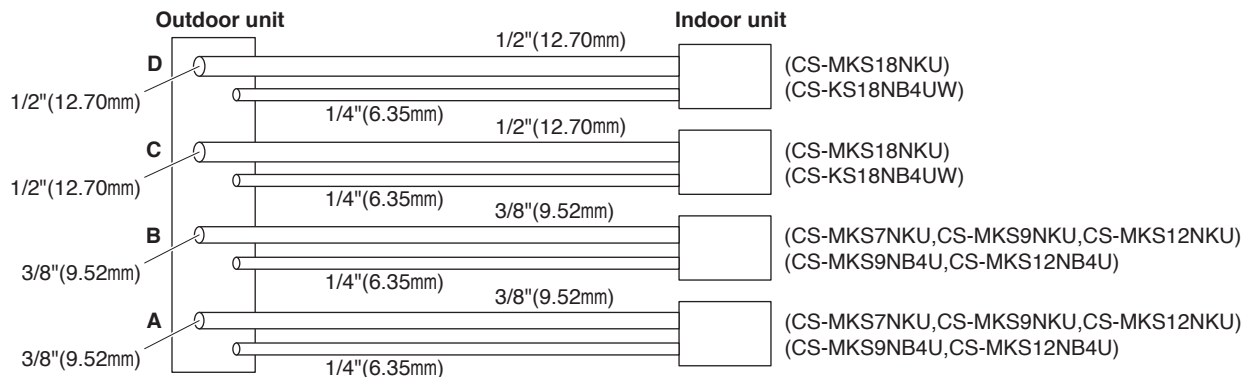

Fig. 4i

(D)

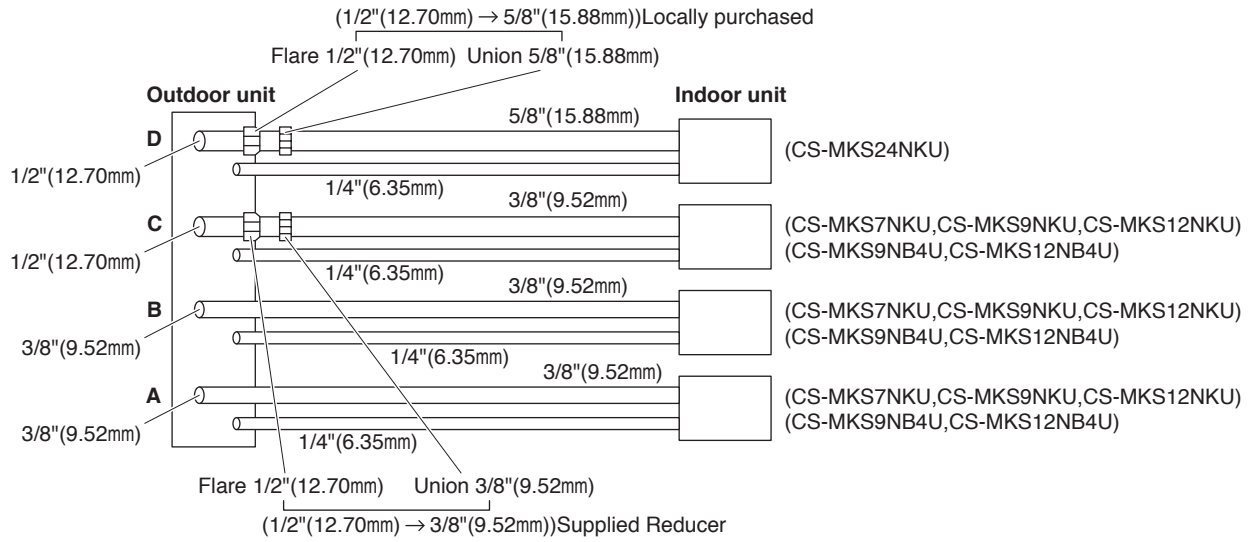

Fig. 4j

(E)

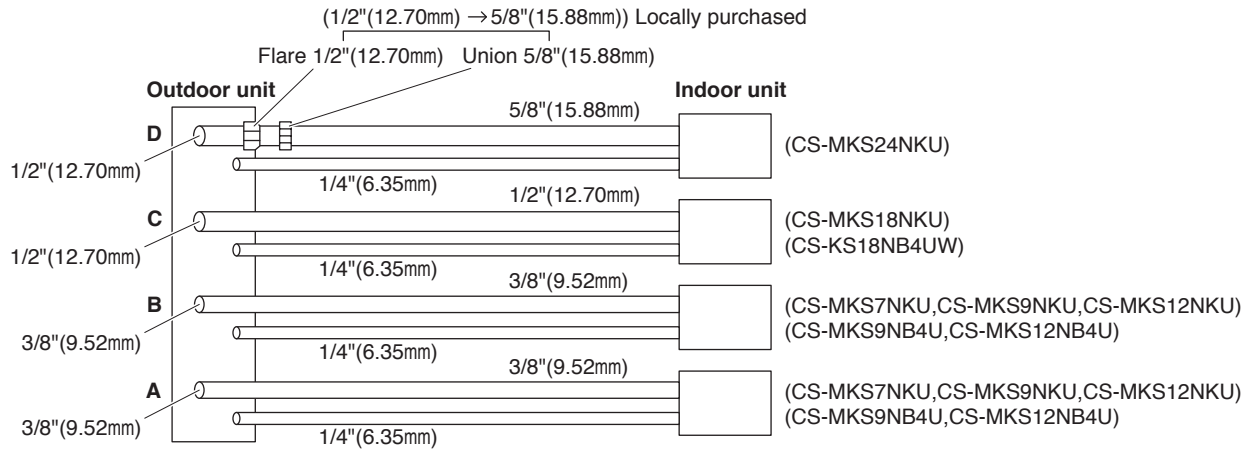

Fig. 4k

2-3. Outdoor Unit

AVOID:

- heat sources, exhaust fans, etc. (Fig. 5a)
- damp, humid or uneven locations.

DO:

- choose a place as cool as possible.
- choose a place that is well ventilated.
- install in a location where at least two sides are unobstructed, so that the flow of air at the intake port or exhaust port is not blocked, and so that sufficient space is ensured for maintenance to be carried out without trouble. In general the top also must be unobstructed. (Fig. 5b)
- provide a solid base (level concrete pad, concrete block, 6" × 1'4" (15 × 40 cm) beams or equal), a minimum of 6" (15 cm) above ground level to reduce humidity and protect the unit against possible water damage and decreased service life. (Figs. 5c and 5d)



CAUTION

A solid base must not cover the hole of the bottom plate.

- install cushion rubber under unit's feet to reduce vibration and noise. (Fig. 5e)
- use lug bolts or equal to bolt down unit, reducing vibration and noise.
- install in a location where no antenna of a television or radio exists within 10' (3 m).

2-4. Baffle Plate for the Outdoor Unit

NOTE

It is recommended to use baffle plates.

When the outdoor unit is installed in a position exposed to strong wind (such as seasonal winds with low air temperature in winter), baffle plates must be installed on the outdoor unit. (Fig. 5f)

This unit is designed so that the fan of the outdoor unit runs at low speed when the air conditioner is operated at low outdoor air temperatures. When the outdoor unit is exposed to strong wind, the system pressure drops because of the freeze protector.

Install a pair of windbaffle plates at the front and back of the outdoor unit if it will be subject to strong wind during the winter. (Figs. 5f, 5g, 5h, 5i, and 5j)

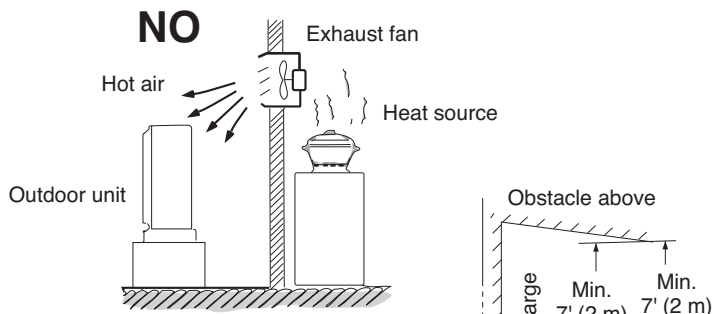

Fig. 5a

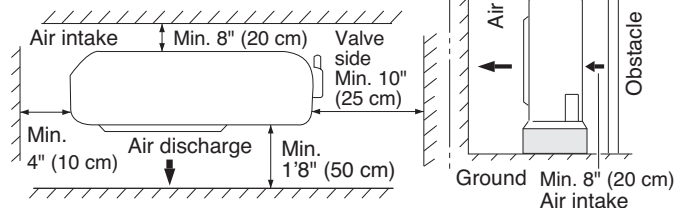

Fig. 5b

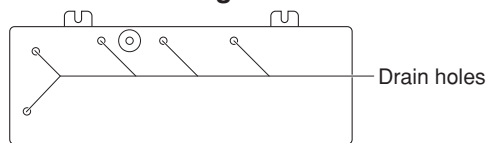

Fig. 5c

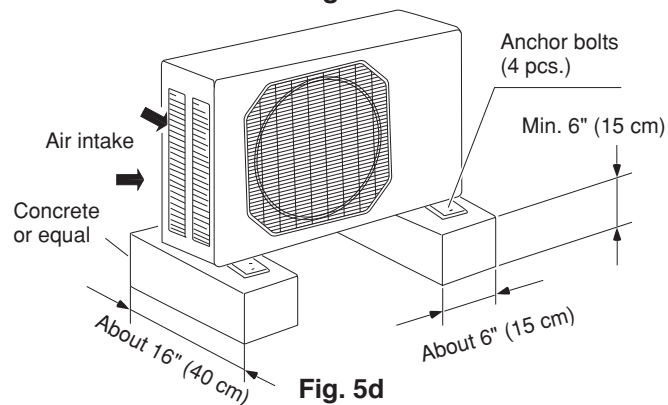

Fig. 5d

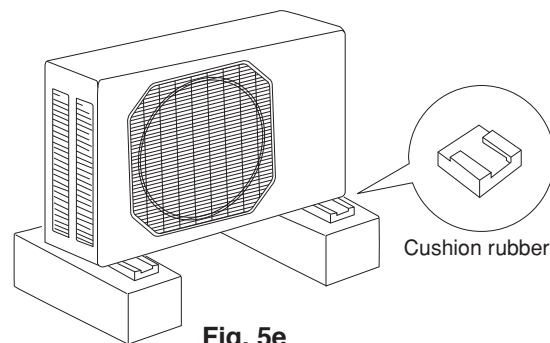

Fig. 5e

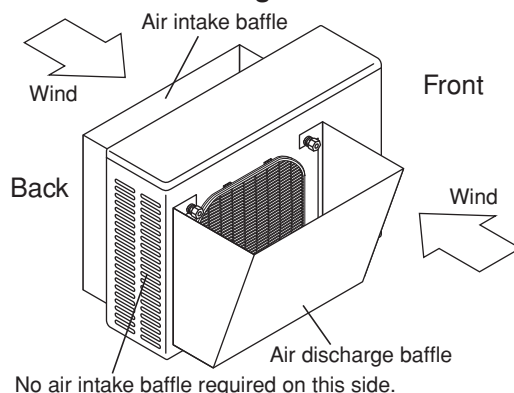

Fig. 5f

(1) Recommended dimensions of the baffle plates

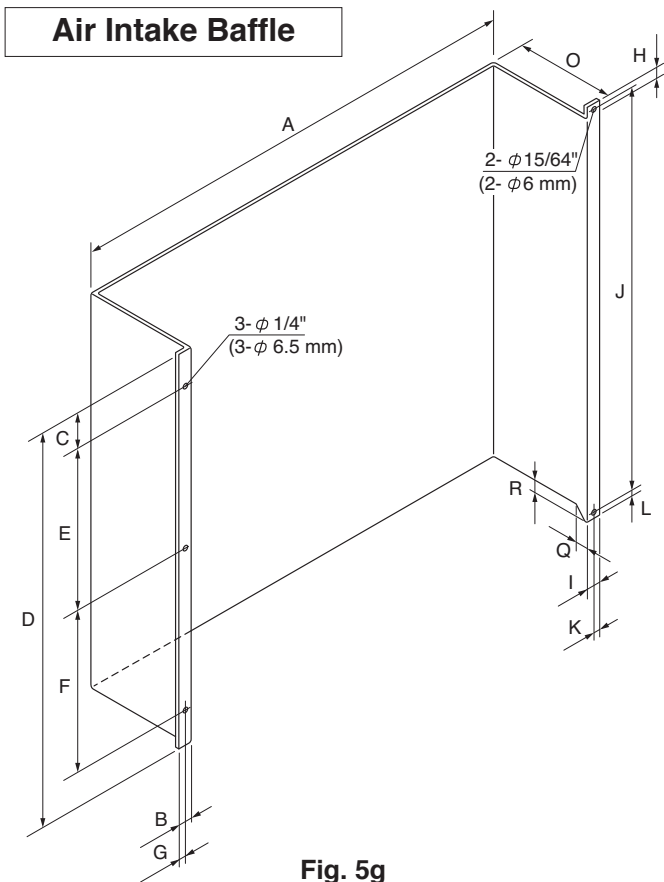

Fig. 5g

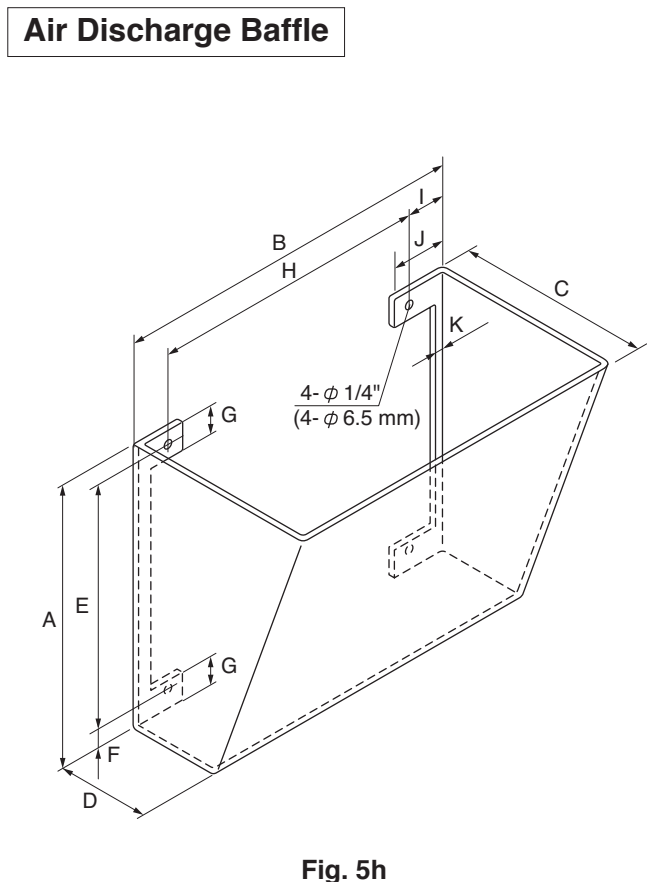

Fig. 5h

For Air Intake

Dimensions		A	B	C	D	E	F	G	H	I	J	K	L	O	Q	R
Model	(inch)	25-3/16	25/32	1-31/32	25	10-5/8	10-5/8	25/64	25/32	19/32	25-7/8	19/64	25/64	5-29/32	25/32	25/32
	(mm)	640	20	50	635	270	270	10	20	15	657	7.5	10	150	20	20
CU-4KS31NBU	(inch)	25-3/16	25/32	1-3/8	30-29/32	13-25/32	13-25/32	25/64	25/32	19/32	31-25/32	19/64	25/64	5-29/32	25/32	25/32
	(mm)	640	20	35	785	350	350	10	20	15	807	7.5	10	150	20	20

For Air Discharge

Dimensions		A	B	C	D	E	F	G	H	I	J	K
Model	(inch)	22-1/16	23-1/32	13-25/32	5-29/32	19-9/32	1-3/8	2-5/32	18-5/16	2-3/8	3-11/32	31/32
	(mm)	560	585	350	150	490	35	55	465	60	85	25

Material to be used: Metal plate with corrosion protection treatment

Plate thickness: 0.0394 to 0.0472" (1.0 to 1.2 mm)

(2) Parts required (field supply except for screws)

Air Intake Baffle

Item	Q'ty	Remarks
Baffle plate	1	
Screw 5/32 × 15/32" (4 × 12 mm) tapping	2	Attached to outdoor unit
Bolt 15/64 × 19/32 – 25/32" (M6 × 15 – 20 mm)	3	
Nut 15/64" (M6)	3	
Washer	3	
Spring washer	3	

Air Discharge Baffle

Item	Q'ty	Remarks
Baffle plate	1	
Bolt 15/64 × 13/32 – 19/32" (M6 × 10 – 15 mm)	4	
Nut 15/64" (M6)	4	
Washer	4	
Spring washer	4	

(3) Installation procedure

1. Air Intake Baffle

(1) Left side

1. Remove the top panel from the unit.
2. Remove the panel side L, and drill 3 holes of $\varnothing 1/4$ inch (6.5 mm) at the prescribed position.
3. Install the windbaffle on the unit using field supply bolts and nuts.
4. Recommended bolts to be used are 15/64" (M6 ISO standard), and the recommended length of the bolts is between 19/32 – 25/32 inch (15 – 20 mm).
5. Use washers and spring washers to tightly fasten the windbaffle to the unit.

(2) Right side

1. Remove the top panel from the unit.
2. Use 2 preholes on the panel side R to install the baffle plate.
3. Remove the panel side R from the unit by removing the screws. These screws are used in step 4 below.
4. Put (sandwich) the windbaffle between the unit and the panel side R, then install the windbaffle on the unit using the above screws. Be careful not to damage the screw holes.

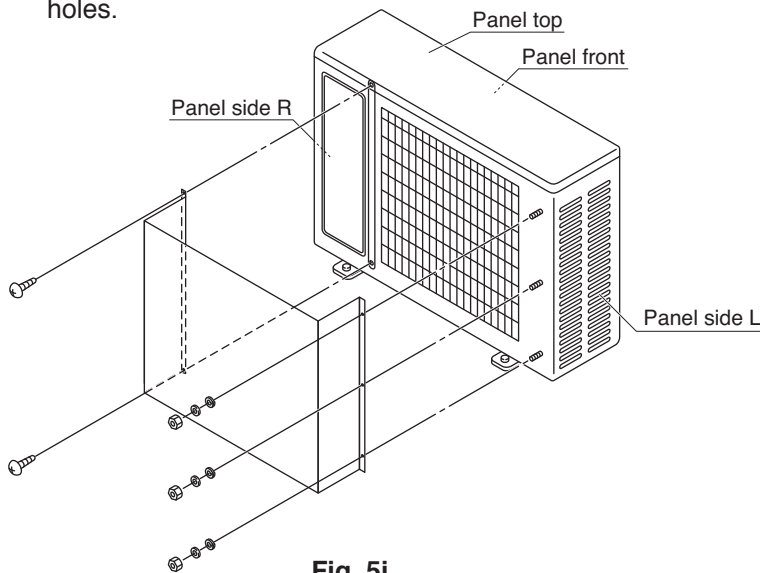

Fig. 5i

2. Air Discharge Baffle

1. Remove the panels front, top, side L and R from the unit and drill 4 holes of $\varnothing 1/4$ inch (6.5 mm) at the prescribed positions.
2. Install the windbaffle on the unit using field supply bolts and nuts.
3. Recommended bolts to be used are 15/64" (M6 ISO standard), and the recommended length of the bolts is between 13/32 – 19/32 inch (10 – 15 mm).
4. Use washers and spring washers to tightly fasten the windbaffle to the unit.

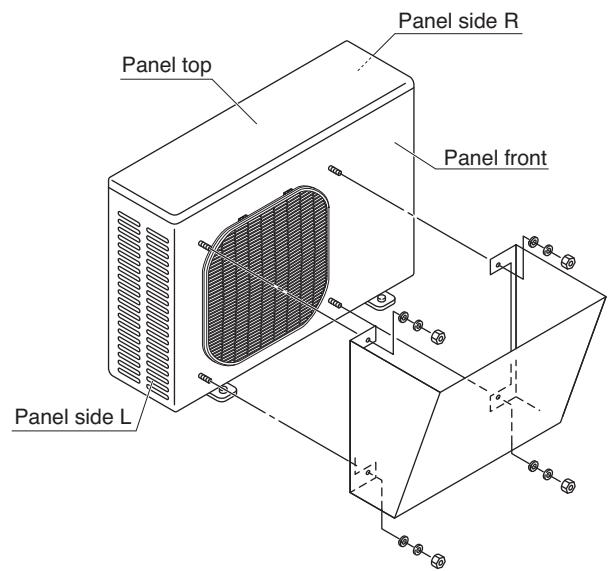

Fig. 5j

NOTE

- In order to prevent contact of the bolts and heat exchanger and other parts inside the unit, install the windbaffle using bolts from inside the unit and fasten the bolts with nuts from outside the unit.
- When the windbaffle is installed on the unit, the unit has higher wind resistance. In order to prevent the unit from falling over, anchor the legs of the unit using anchor bolts (or similar method).

(4) Precautions for installation

1. Be sure not to damage painted surfaces.
2. Finish the edges of the windbaffle to avoid cuts or injury.
3. Drilling of holes must be carefully done so that no damage is caused to external or internal parts of the unit. Particular care must be taken that drill chips do not drop into the unit.

2-5. Outer Dimensions of Outdoor Unit

(1) CU-3KS19NBU

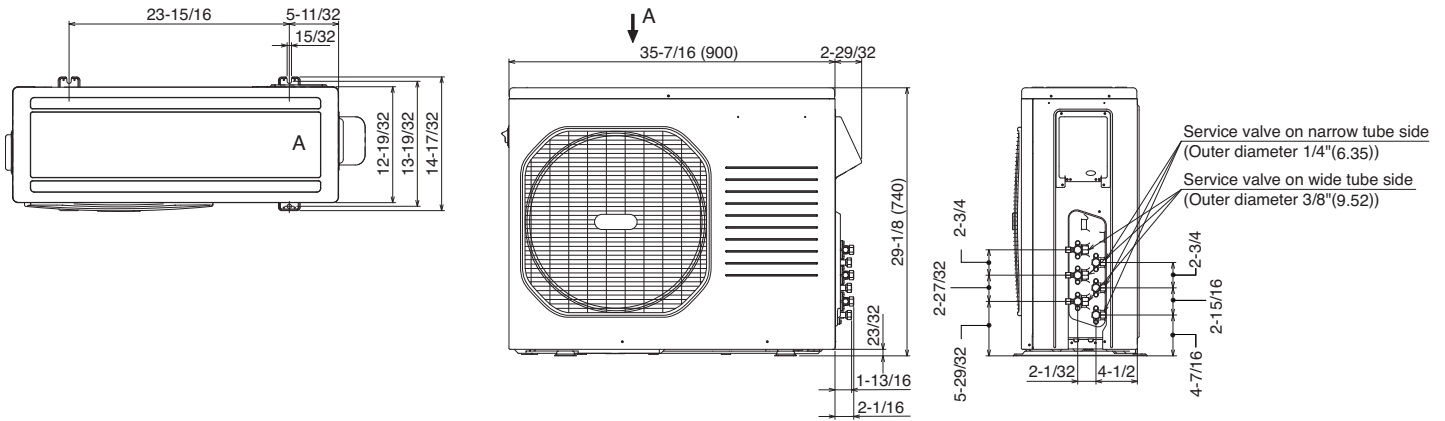

Fig. 6a

(2) CU-4KS24NBU

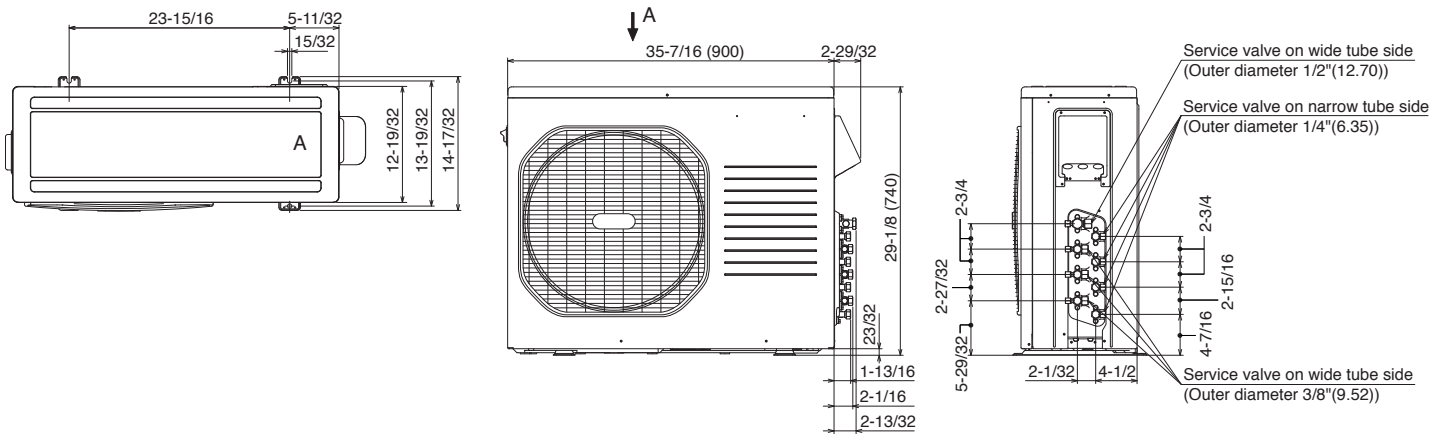

Fig. 6b

(3) CU-4KS31NBU

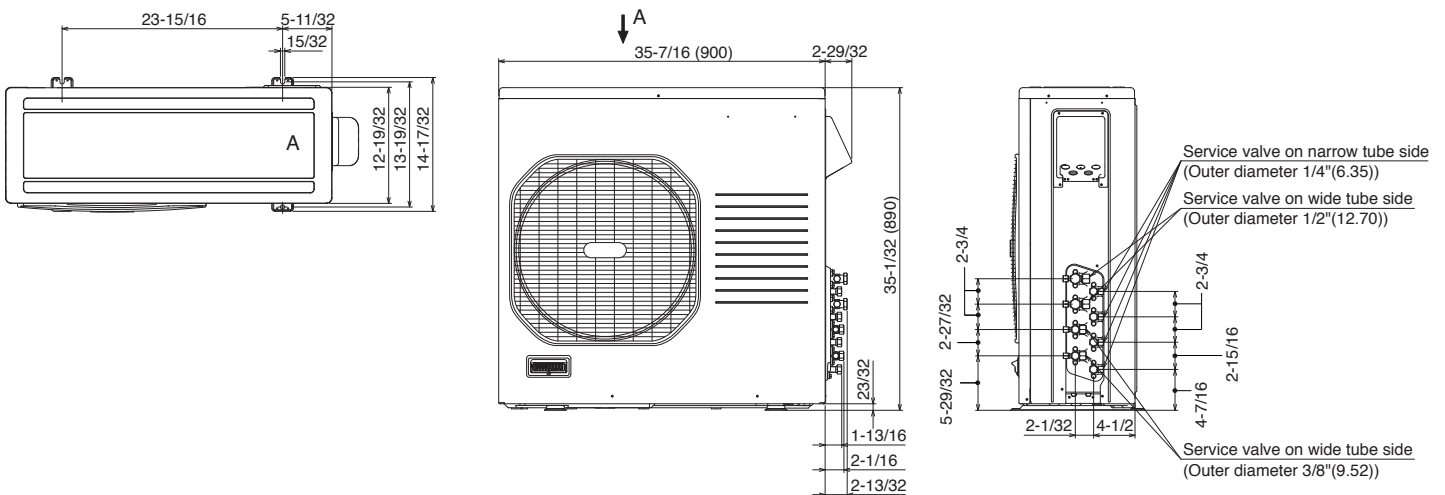

Fig. 6c

unit: inch (mm)

2-6. Diagram of Outdoor Unit Installation

Never install only a single indoor unit.

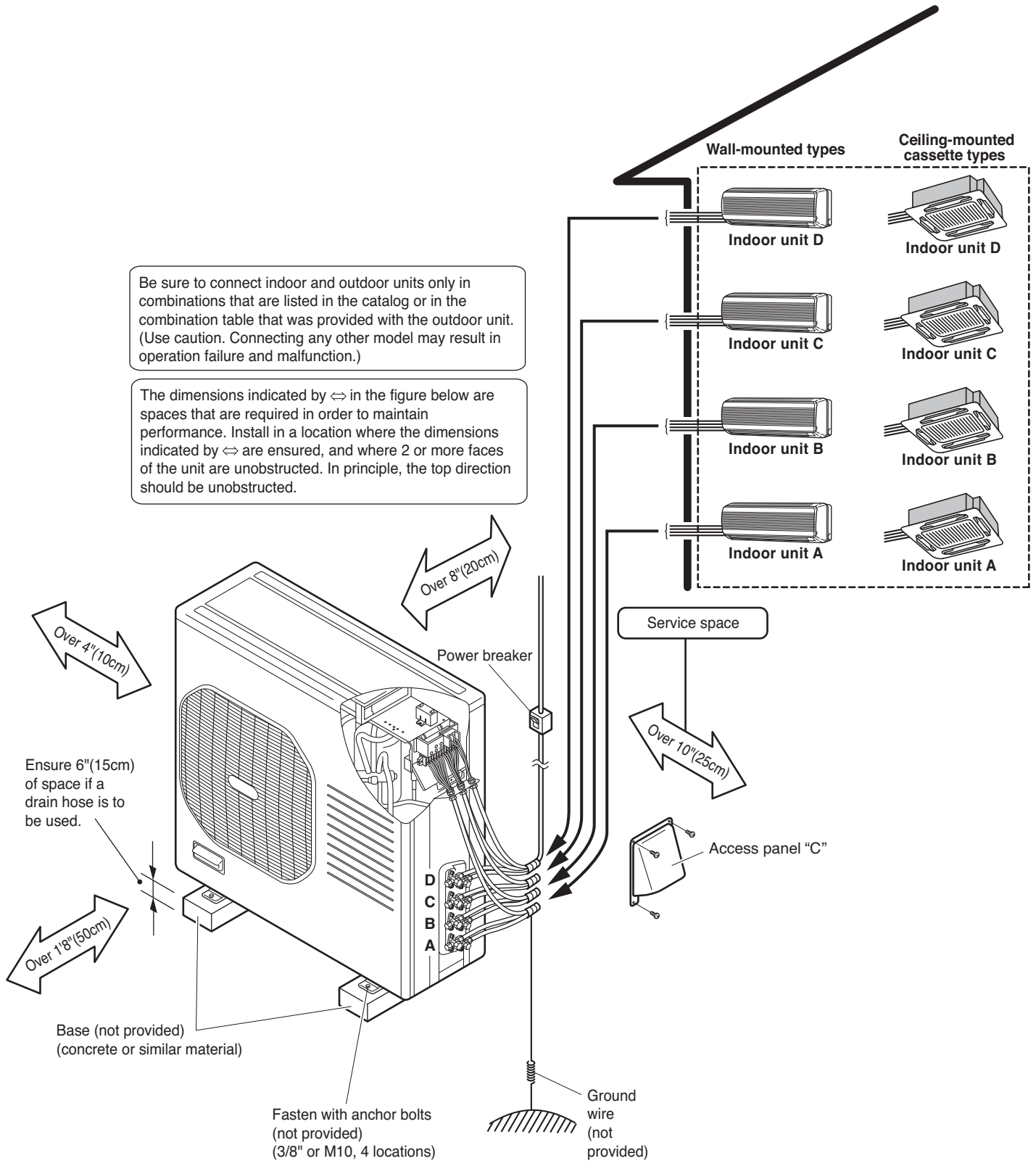

Fig. 7

3. Installation Process

3-1. Embedding the Tubing and Wiring

- Do not connect tubes to locations that are embedded.
- Be sure to bind refrigerant tubing and inter-unit cables together with vinyl tape.
- The power cable must be obtained on-site.
(#12: Less than 85 ft.)
... AWG (American Wire Gauge)
- Be sure to apply the provided labels to both ends of the inter-unit cables to prevent miswiring.
- Securely seal the end of embedded tubing with vinyl tape in order to prevent dirt or moisture entry.
- In order to prevent insulation breakdown and ground faults, do not allow the wire ends to come in contact with rainwater, or be subject to dew condensation.

3-2. Use of the Flaring Method

Many of the conventional split system air conditioners employ the flaring method to connect refrigerant tubes which run between indoor and outdoor units. In this method, the copper tubes are flared at each end and connected with flare nuts.

3-3. Flaring Procedure with a Flare Tool

- (1) Cut the copper tube to the required length with a tube cutter. It is recommended to cut approx. 12" to 20" (30 to 50 cm) longer than the tubing length you estimate.
- (2) Remove burrs at the end of the copper tube with a tube reamer or file. This process is important and should be done carefully to make a good flare.
(Fig. 8)

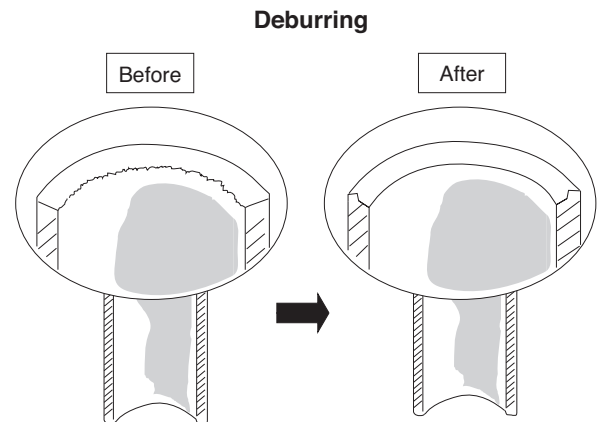

Fig. 8

NOTE

When reaming, hold the tube end downward and be sure that no copper scraps fall into the tube. (Fig. 9)

(3) Remove the flare nut from the unit and be sure to mount it on the copper tube.

(4) Make a flare at the end of copper tube with a flare tool.* (Figs. 10 and 11)

(*Use "RIDGID" or equivalent.)

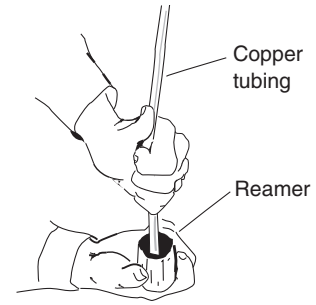

Fig. 9

NOTE

A good flare should have the following characteristics:

- inside surface is glossy and smooth.
- edge is smooth.
- tapered sides are of uniform length.

If the special R410A flare tool is used:

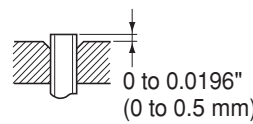

If the previous flare tool (clutch-type) is used:

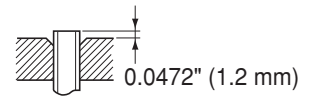

Adjust so that the amount of tube protrusion is as shown in the figure.

Fig. 10

3-4. Caution before Connecting Tubes Tightly

a) Be sure to apply a sealing cap or water-proof tape to prevent dust or water from getting into the tubes before they are used.

b) Be sure to apply refrigerant lubricant to the matching surfaces of the flare and union before connecting them together. This is effective for reducing gas leaks. (Fig. 12)

c) For proper connection, align the union tube and flare tube straight with each other, then screw in the flare nut lightly at first to obtain a smooth match. (Fig. 13)

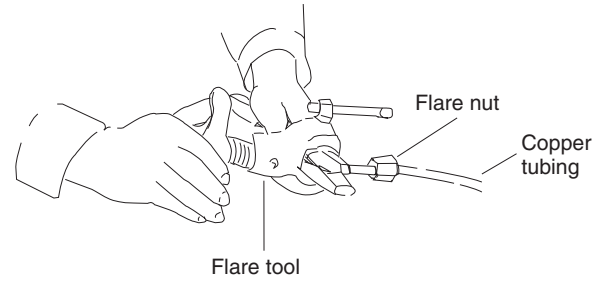

Fig. 11

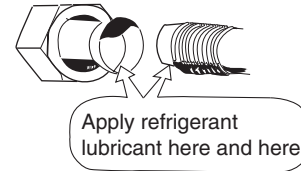

Fig. 12

3-5. Tubing Connections

a) Temporary connection: Screw in 3 – 5 turns by hand. (Fig. 14)

b) To fasten the flare nuts, apply specified torque as:

Table 4

Tube Dia.	Nut	Tightening Torque
1/4" (6.35 mm)	21/32" (17 mm)	Approx. 120 – 160 lbs-in (140 – 180 kgf-cm)
3/8" (9.52 mm)	7/8" (22 mm)	Approx. 300 – 360 lbs-in (340 – 420 kgf-cm)
1/2" (12.70 mm)	1-1/32" (26 mm)	Approx. 430 – 480 lbs-in (490 – 550 kgf-cm)
5/8" (15.88 mm)	1-5/32" (29 mm)	Approx. 590 – 710 lbs-in (680 – 820 kgf-cm)

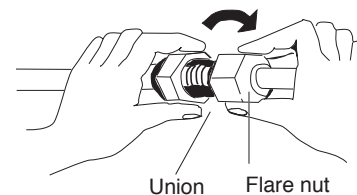
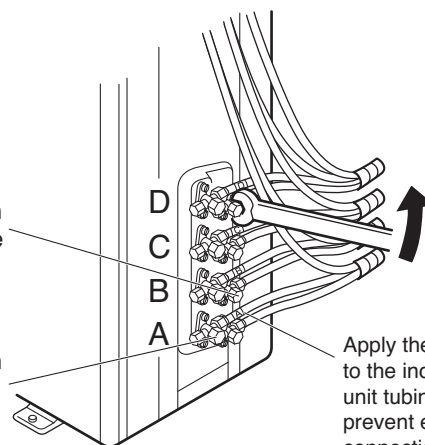

Fig. 13



Service valve on narrow tube side

Service valve on wide tube side



Apply the provided labels to the indoor and outdoor unit tubing connectors to prevent errors in connections.

Fig. 14



CAUTION

Be sure to match refrigerant tubing and electric wiring between indoor and outdoor units.

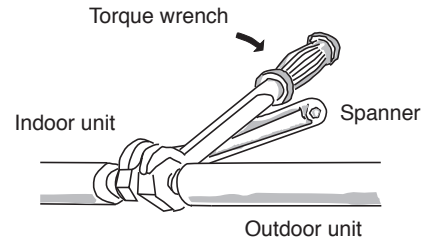

Fig. 15

3-6. Insulation of Refrigerant Tubing

IMPORTANT

To prevent heat loss and wet floors due to dripping of condensation, **both tubes must be well insulated with a proper insulation material.**

The thickness of the insulation should be a minimum 5/16" (8 mm). (Fig. 16)

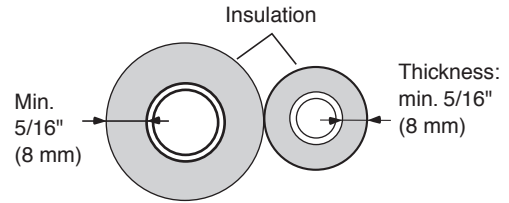

Fig. 16

■ For wall-mounted units

After connecting the refrigerant tubing to the outdoor unit and performing a leak test on the connecting part, insulate it with the tubing insulation. (Fig 17a)

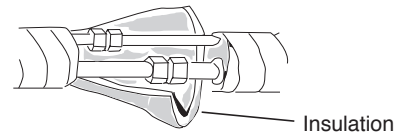

Fig. 17a

■ For ceiling-mounted cassette units

Wind the insulation tape around the flare nuts at the tube connections. Secondly cover up the tubing connections with the flare insulation (1/8" (T3, supplied)). Then wind the other flare insulation (3/16" (T5, supplied)). Finally, fasten the insulation at both ends with the supplied vinyl ties. (Fig. 17b)

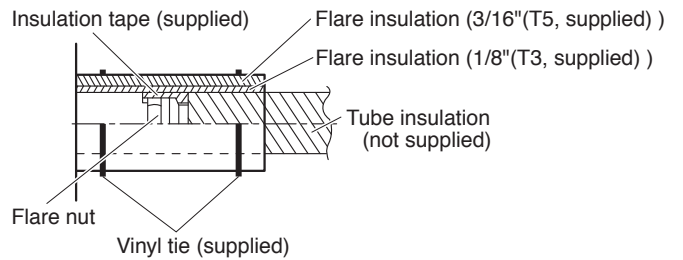

Fig. 17b

Insulation material

The material used for insulation must have good insulation characteristics, be easy to use, be age resistant, and must not easily absorb moisture.

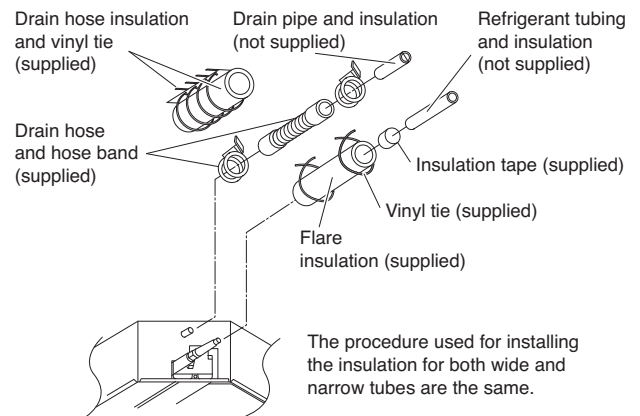

Fig. 17c

Never grasp the drain or refrigerant connecting outlets when moving the unit.

3-7. Taping the Tubes



CAUTION

After a tube has been insulated, never try to bend it into a narrow curve, as this may cause the tube to break or crack.

- (1) At this time, the 2 refrigerant tubes (and electrical wire if local codes permit) should be taped together with armoring tape. The drain hose may also be included and taped together as 1 bundle with the tubing.
- (2) Wrap the armoring tape from the bottom of the outdoor unit to the top of the tubing where it enters the wall. As you wrap the tubing, overlap half of each previous tape turn. (Fig. 18)
- (3) Clamp the tubing bundle to wall, using 1 clamp approx. every 47" (120 cm).

NOTE

Do not wind the armoring tape too tightly, since this will decrease the heat insulation effect. Also, be sure the condensation drain hose splits away from the bundle and drips clear of the unit and the tubing.

3-8. Finishing the Installation

After finishing insulating and taping over the tubing, use sealing putty to seal off the hole in the wall to prevent rain and draft from entering. (Fig. 19)

4. Air Purging

Air and moisture remaining in the refrigerant system have undesirable effects as indicated below. Therefore, they must be purged completely.

- pressure in the system rises
- operating current rises
- cooling efficiency drops
- moisture in the air may freeze and block capillary tubing
- water may lead to corrosion of parts in the refrigerant system

■ Air Purging with a Vacuum Pump (for Test Run)

- In order to protect the earth's environment, be sure to use a vacuum pump to perform the air purge. (Never perform an air purge by using the refrigerant gas cylinder or other external gas, or by using the gas inside the outdoor unit.)

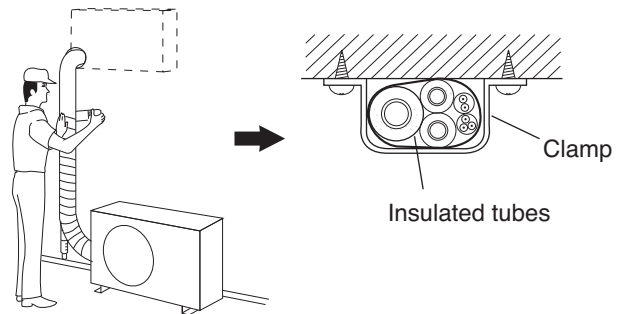

Fig. 18

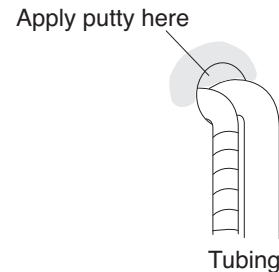

Fig. 19

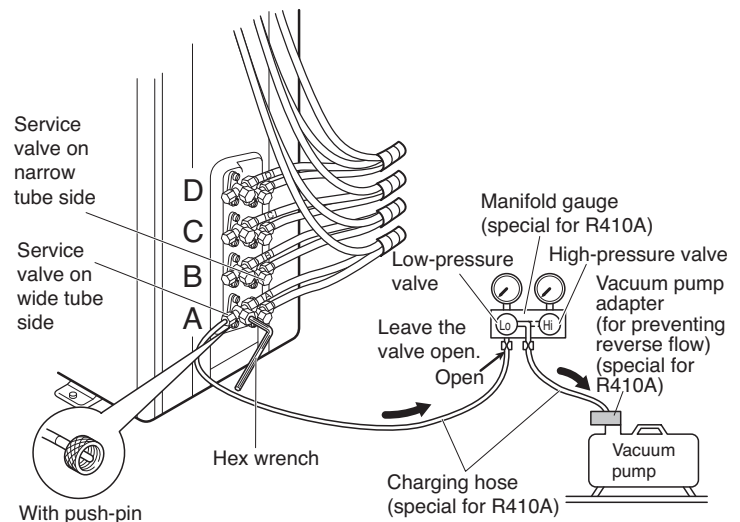

Fig. 20



CAUTION

In order to prevent charging errors with the air conditioner that uses R410A, the screw diameter at the service valve charging port has been changed. When recharging or performing other servicing, use the special charging hose and manifold gauge.

Perform the air purge for tubes A, B, C, and D. Use the same procedures for all tubes.

- (1) Check that each tube (both narrow and wide tubes) between the indoor and outdoor units have been properly connected and all wiring for the test run has been completed. Note that both narrow and wide tube service valves on the outdoor unit are kept closed at this stage.
- (2) Using an adjustable wrench or box wrench, remove the valve caps from the service valve on both narrow and wide tubes.
- (3) Connect a vacuum pump and a manifold valve (with pressure gauges) to the service port on the wide tube service valve. (Fig. 20).



CAUTION

Before using the vacuum pump adapter, read the vacuum pump adapter manual, and use the adapter correctly.



CAUTION

Be sure to use a manifold valve for air purging. If it is not available, use a stop valve for this purpose. The "Hi" knob of the manifold valve must always be kept closed.

- (4) With the "Lo" knob of the manifold valve open and high-pressure valve ("Hi") closed completely, run the vacuum pump. Run the pump until the pressure is -101 kPa (-76 cmHg). The operation time for the vacuum pump varies with tubing length and the capacity of the pump. The following table shows the amount of time required for evacuation:

Table 5

Required time for evacuation when capacity of 100 liter/h vacuum pump is used
20 min. or more

NOTE

The required time in Table 5 is calculated based on the assumption that the ideal (or target) vacuum condition is around 10 mmHg abs.

- (5) With the vacuum pump still running, close the "Lo" knob of the manifold valve. Then stop the vacuum pump. Fully close the low-pressure valve and stop the vacuum pump. (Wait 1 – 2 minutes and check that the manifold gauge pointer does not return. If it does return, find and repair the leak, then apply the vacuum again.)
- (6) With a hex wrench, turn the valve stem on the narrow tube service valve counter-clockwise by 90 degrees (1/4 turn) for 10 seconds, and then turn the stem clockwise to close it again.



CAUTION

Be sure to completely insert the hex wrench before attempting to turn the valve.

- (7) With a standard screwdriver, turn the wide tube service valve stem counterclockwise to fully open the valve.
- (8) Turn the narrow tube service valve stem counter-clockwise to fully open the valve.
- (9) Loosen the vacuum hose connected to the wide tube service port slightly to release the pressure. Then, remove the hose.
- (10) Leak test all joints at the tubing (both indoor and outdoors) with liquid soap. Bubbles indicate a leak. Be sure to wipe off the soap with a clean cloth.



CAUTION

If a CFC gas detector is used, use a special detector for HFC refrigerant (such as R410A and R134a).

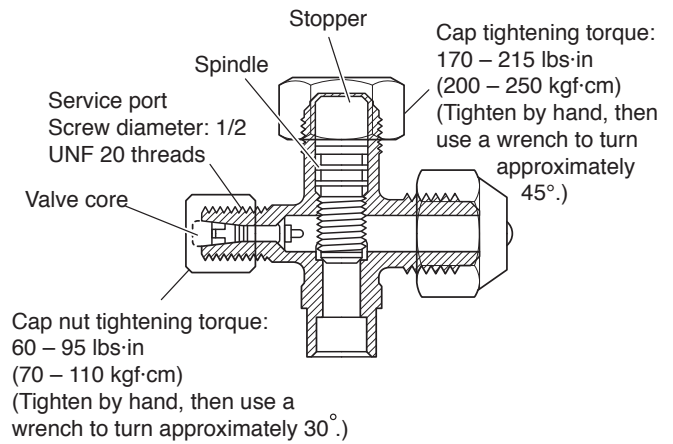

<Structure of service valve on wide tube side>

NOTE

External diameter of service port R410A: 5/16"

Fig. 21

- When using a hex wrench to open the spindle, an extremely small amount of refrigerant may leak. This does not indicate a problem.
- Use a hex wrench of a type to which force can be easily applied.

- (11) Replace the flare nut on the wide tube service port and fasten the flare nut securely with an adjustable wrench or box wrench. Next, mount the valve cap and tighten it with a torque wrench (the cap needs to be tightened with the torque of 180 lbs·in (200 kgf·cm)). This process is very important to prevent gas from leaking from the system.
- (12) Test run the air conditioner. (See page 26.)
- (13) While the air conditioner is running, apply liquid soap to check for any gas leaks around the service valves or caps.
- (14) If there is no leakage, stop the air conditioner.
- (15) Wipe off the soap on the tubing.

This completes air purging with a vacuum pump and the air conditioner is ready for actual operation.

■ Pump Down

In order to protect the earth's environment, be sure to perform pump-down to recover refrigerant gas without releasing it into the atmosphere.

- When relocating or disposing of the air conditioner, request this service from the dealer where the unit was purchased, or from an appropriate agent. Perform pump-down as described below.

What is pump-down?

- Pump-down refers to recovering the refrigerant gas from the refrigerant cycle at the outdoor unit. This work must be performed during cooling operation. The refrigerant gas cannot be recovered during heating operation.
- During winter, or if the temperature sensor prevents cooling operation, perform "forced cooling operation."

Pump-down procedure

- (1) Fully close the spindles at the valves on the narrow tube side of tubes A, B, C and D. (Refer to Fig. 22.)
- (2) Connect the manifold gauge to the charging port at the valve on the wide tube side of tube D. Purge the air from the charging hose. (Refer to Fig. 23.)
- (3) Perform cooling operation or forced cooling operation. When the pressure at the low-pressure side is 0.05 – 0.1 MPaG (0.5 – 1 kg/cm²G), fully close the spindles at the valves on the wide tube side of tubes A, B, C, and D, and immediately stop operation. (Refer to Fig. 23.)
In the winter, the outdoor unit may stop after 5 - 10 minutes of operation. This is in order to protect the indoor unit heat exchanger from freezing and does not indicate a problem.
- (4) Disconnect the manifold gauge and the inter-unit tubes, and attach the caps and flare nuts. At this point, pump-down is completed. (If the caps and flare nuts are not reattached, there is the danger of gas leakage.) (Refer to Fig. 24.)

If pump-down is not possible

If the air conditioner cannot be operated because of a malfunction or other cause, use a refrigerant recovery device to recover the refrigerant.

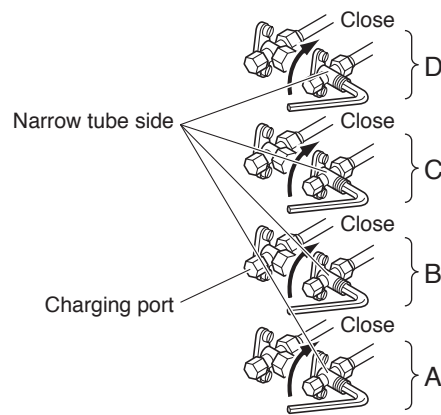

Fig. 22

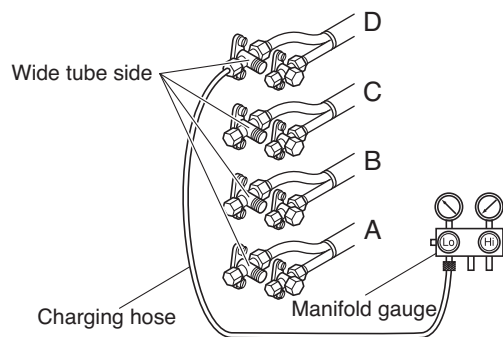

Fig. 23

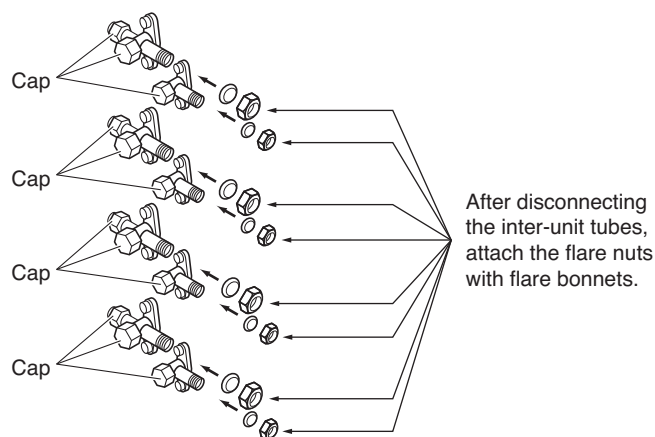

Fig. 24

5. Wiring Instructions

5-1. General Precautions on Wiring

- (1) Before wiring, confirm the rated voltage of the unit as shown on its nameplate, then carry out the wiring closely following the wiring diagram.
- (2) Provide a power outlet to be used exclusively for each unit, with a power supply disconnect and circuit breaker for overcurrent protection provided in the exclusive line.
- (3) To prevent possible hazard due to insulation failure, the unit must be grounded.
- (4) Each wiring connection must be done tightly and in accordance with the wiring system diagram. Wrong wiring may cause the unit to misoperate or become damaged.
- (5) Do not allow wiring to touch the refrigerant tubing, compressor, or any moving parts of the fan.
- (6) Unauthorized changes in the internal wiring can be very dangerous. The manufacturer will accept no responsibility for any damage or misoperation that occurs as a result of such unauthorized changes.

5-2. Recommended Wire Length and Diameter

Regulations on wiring diameter differ from locality to locality. For field wiring requirements, please refer to your local electrical codes. Carefully observe these regulations when carrying out the installation.

Table 6 shows maximum wire lengths for control line and power line and fuse or circuit capacity.

NOTE

Refer to the wiring system diagram (Fig. 25a or 25b) for the meaning of (A), (B), and (C) in Table 6.

Refer to your local codes or in the absence of local codes see the National Electric Code: ANSI/NFPA70.

Table 6

Model	AWG	Max. Power Line Length (ft.) (A)	Max. Control Line Length (ft.) (B) (C)	Fuse or Circuit Capacity
		(#12)	(#14)	
CU-3KS19NBU		85 (Max.)	82 (Max.)	15 A
CU-4KS24NBU		85 (Max.)	82 (Max.)	20 A
CU-4KS31NBU		85 (Max.)	100 (Max.)	20 A

... AWG (American Wire Gauge)



WARNING

- Be sure to comply with local codes on running the wire from the indoor unit to the outdoor unit (size of wire and wiring method, etc.).
- Each wire must be firmly connected.
- No wire should be allowed to touch refrigerant tubing, the compressor, or any moving part.
- Be sure to connect power wires correctly matching up numbers on terminals of the outdoor unit and respective indoor units A – D.



CAUTION

- Be sure to connect the power supply line to the outdoor unit as shown in the wiring diagram. The indoor unit draws its power from the outdoor unit.
- Do not run wiring for antenna, signal, or power lines of television, radio, stereo, telephone, security system, or intercom any closer than 3'4" (1 m) from the power cable and wires between the indoor and outdoor units. Electrical noise may affect the operation.



WARNING

- To avoid the risk of electric shock, each air conditioner unit must be grounded.
- For the installation of a grounding device, please observe local electrical codes.
- Grounding is necessary, especially for units using inverter circuits, in order to release charged electricity and electrical noise caused by high tension. Otherwise, electrical shock may occur.
- Place a dedicated ground more than 7' (2 m) away from other grounds and do not have it shared with other electric appliances.

*** NOTE**

Disconnect switch may be required by national or local codes.



CAUTION

Always comply with national and local code requirements.

5-3. Wiring System Diagram

3 indoor units with CU-3KS19NBU

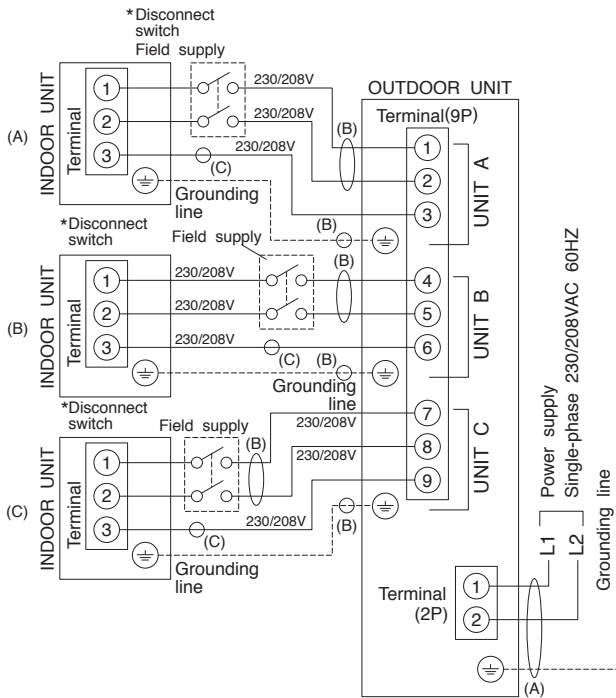

Fig. 25a

4 indoor units with CU-4KS24NBU, CU-4KS31NBU

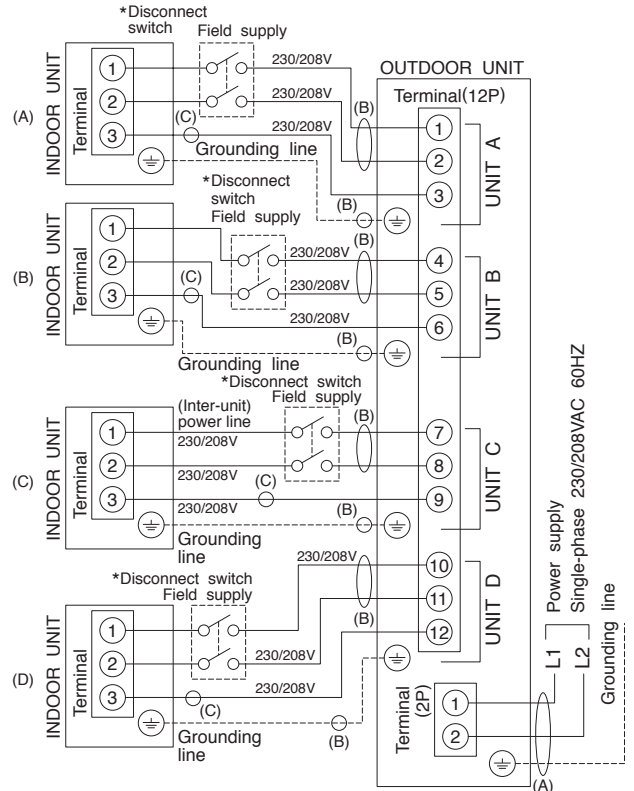

Fig. 25b

5-4. How to Connect Wiring to the Terminal



WARNING

Loose wiring may cause the terminal to overheat or result in unit malfunction. A fire hazard may also exist. Therefore, be sure all wiring is tightly connected.

When connecting each power wire to the corresponding terminal, follow the instructions “How to connect wiring to the terminal” and fasten the wire securely tight with the fixing screw of the terminal plate.

How to connect wiring to the terminal

a) For Indoor Unit

- (1) Cut the wire end with a cutting pliers, then strip the insulation to expose the wire about 9/32" (7 mm). See the label (Fig. 26) near the terminal plate.
- (2) Using a screwdriver, loosen the terminal screw on the terminal plate.
- (3) Insert the wire and tighten the terminal screw completely using a screwdriver.

b) For Outdoor Unit

■ For solid core wiring (or F-cable)

- (1) Cut the wire end with a cutting pliers, then strip the insulation to expose the solid wire about 15/16" (25 mm). (Fig. 27)
- (2) Using a screwdriver, remove the terminal screw(s) on the terminal plate.
- (3) Using the pliers, bend the solid wire to form a loop suitable for the terminal screw.
- (4) Shape the loop wire properly, place it on the terminal plate and fix it securely with the removed terminal screw using a screwdriver.

■ For stranded wiring

- (1) Cut the wire end with a cutting pliers, then strip the insulation to expose the stranded wiring about 3/8" (10 mm) and tightly twist the wire ends. (Figs. 28 and 29)
- (2) Using a screwdriver, remove the terminal screw(s) on the terminal plate.
- (3) Using a ring connector fastener or pliers, securely clamp each stripped wire end with a ring connector. (Fig. 28)
- (4) Place the ring connector wire, and replace and tighten the removed terminal screw using a screwdriver. (Fig. 30)

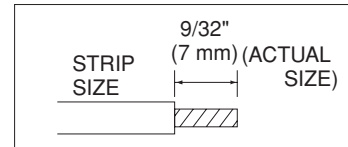

Fig. 26

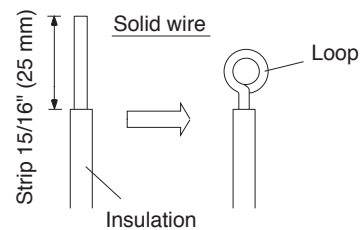

Fig. 27

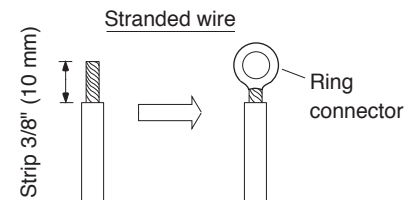

Fig. 28

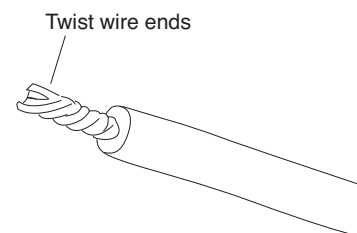

Fig. 29

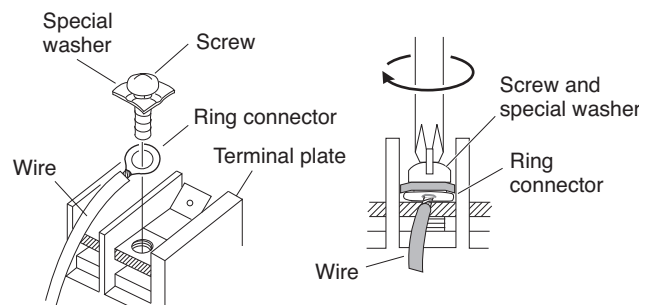

Fig. 30

5-5. Wiring Instructions for the Outdoor Unit



CAUTION

- Be sure to correctly align inter-unit cables A, B, C and D.

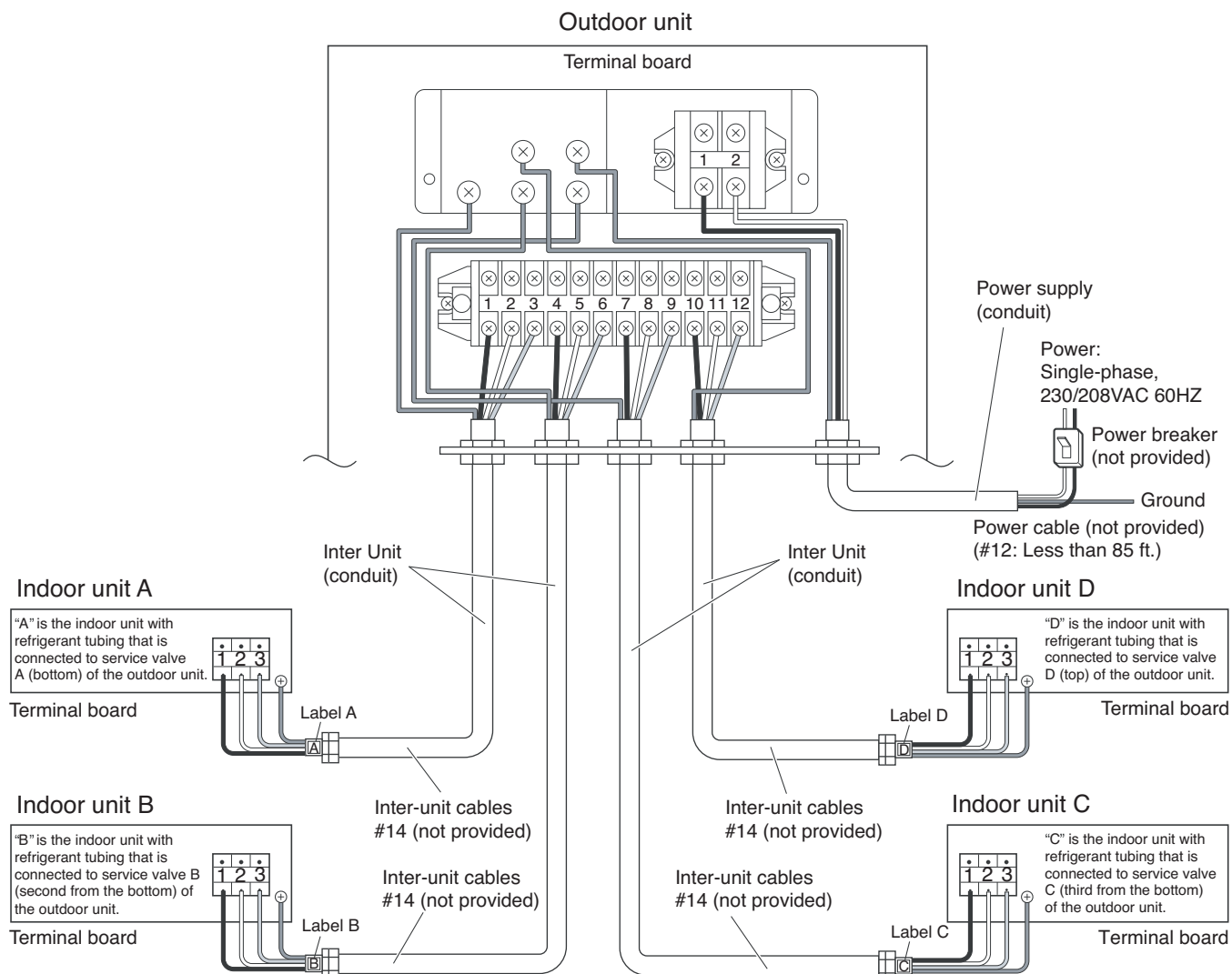

Be sure to perform grounding.

- Attach a ground wire to either the outdoor unit or indoor unit.
- If there is a grounding terminal inside the room, use the grounding screw inside the indoor unit.

- Be sure to apply the provided labels to both ends of the inter-unit cables to prevent miswiring. The units will not function if the wiring connections are incorrect.

... AWG (American Wire Gauge)

Fig. 31

- Use a dedicated air conditioner circuit for power.
- To make connections to the outdoor unit, remove the inspection panel and tubing panel.
- Do not bring the inter-unit cables or power cable into contact with tubing or service valves.
- Use outdoor unit cable fasteners and fasten the inter-unit cables at the location where the cables are double-sheathed.
- Arrange the wiring so that the inter-unit cables are contained in the inspection panel and tubing panel, as shown in Fig. 31.

Regulations on wire size differ from locality to locality. For field wiring requirements, please refer to your local electrical codes. Make sure that the installation fully complies with all local and national regulations.

- (1) Remove access panel "C". (Fig. 32)
- (2) Connect the inter-unit and power supply line according to the drawing on the panel side.
- (3) Be sure to size each wire allowing approx. 4" (10 cm) longer than the required length for wiring. Store excess wiring inside the cabinet.
- (4) When connections are completed, check that all connections are correct as shown in the wiring system diagram on panel side.
- (5) Be sure to ground the unit according to your local codes.

6. Test Run

Performing a test run

- Refer to the test run procedures in the indoor unit installation manual.
- Perform the test run separately for each connected indoor unit. If 2 units are operated simultaneously, it is not possible to correctly check for errors in tubing and wiring.

Checking tubing and wiring

Perform the test run and check that operation is normal. If there is an error in tubing or wiring, the refrigerant may flow to indoor unit B when indoor unit A is operated (for example).



- Stop operation immediately if there is an error in tubing or wiring. Turn the power (breaker) to OFF, and check whether the inter-unit cables are connected incorrectly, or whether the narrow tubes A and B are connected in reverse. Correct the connections.
- If there is an error in tubing, pump-down must be performed. Be sure to perform pump-down. After making corrections, again purge the air from the tubes.

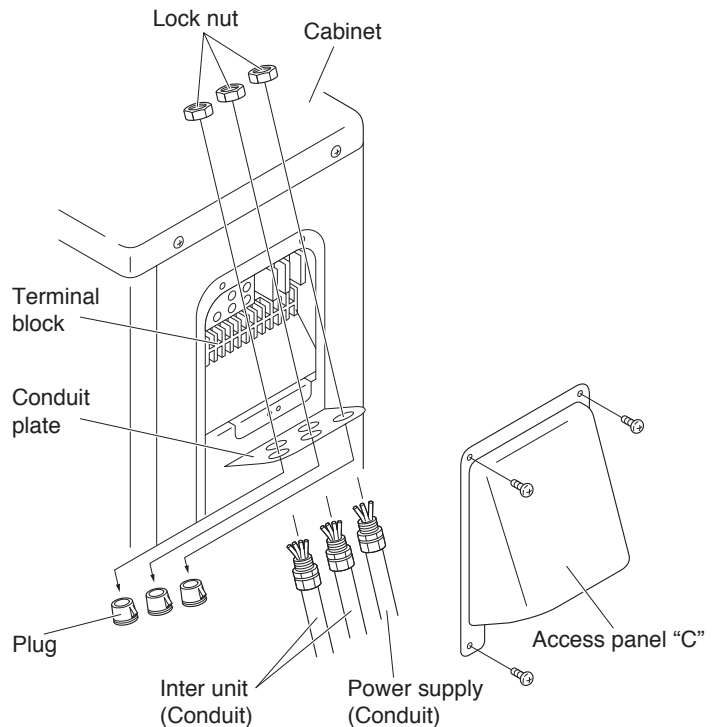

Fig. 32

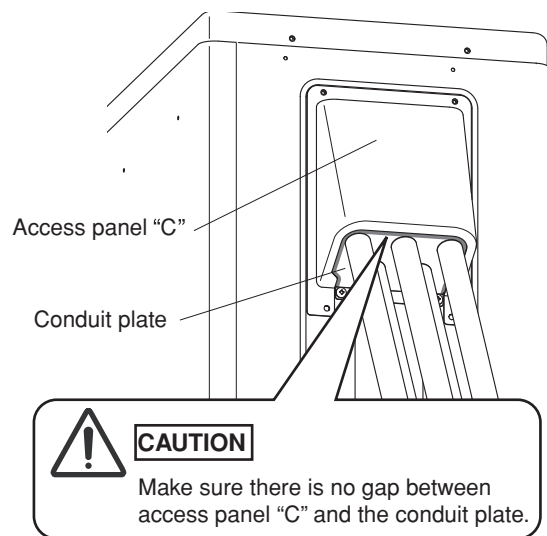

Fig. 33

7. Connecting a Home Automation Device

The HA (white) 4P terminal is located on the indoor unit PCB. If a HA device will be used, connect it to this terminal.

8. Installation Check Sheet

- The strength of the installation location is sufficient to support the air conditioner weight.
- The indoor and outdoor units are installed level and vertically.
- The power and voltage are as specified.
- Inter-unit cables are securely fastened to the terminal board.
- Inter-unit cables are securely fixed.
- The power cable and inter-unit cables are not connected anywhere along their paths.
- The ground wire is securely connected.
- An air purge of the refrigerant circuit has been conducted.
- A leak test of the tubing connections has been performed.
- Thermal insulation has been applied to the tubing connections.
- Drain connections are secure and water drains properly.
- Putty has been used to close the hole in the wall.
- All service valves are fully open.
- Remote controller signals are being positively received.

Free Manuals Download Website

<http://myh66.com>

<http://usermanuals.us>

<http://www.somanuals.com>

<http://www.4manuals.cc>

<http://www.manual-lib.com>

<http://www.404manual.com>

<http://www.luxmanual.com>

<http://aubethermostatmanual.com>

Golf course search by state

<http://golfingnear.com>

Email search by domain

<http://emailbydomain.com>

Auto manuals search

<http://auto.somanuals.com>

TV manuals search

<http://tv.somanuals.com>