

Panasonic

ROOM AIR CONDITIONER

OPERATING INSTRUCTIONS

ENGLISH

MODEL: CW-C100VU
CW-C120VU



Please read these operating instructions thoroughly before using your air conditioner and keep them for future reference.

For assistance, please call: 1-800-211-PANA (7262) or send e-mail to consumerproducts@panasonic.com or refer to www.panasonic.com

Please observe these following safety precautions when using your air conditioner.

- Failure or negligence in observing these safety precautions could cause fire, electrical shock or personal injury.



This symbol (with a white background) denotes an action that is **PROHIBITED**.



These symbols (with a blue background) denote actions that are **COMPULSORY**.

INSTALLATION PRECAUTIONS



- Due to the weight of this product, we recommend that you have a helper to assist in the installation. To avoid injury, use the proper method of lifting. Avoid any sharp edges.

- Make sure the window frame to be used can properly support this product.
- This product must be installed in accordance with all local codes and ordinances.



- Do not install the unit in places where inflammable gas, fumes or soot may be generated.

OPERATION PRECAUTIONS



- Operate your air conditioner from a stable 115 volt AC supply.

- Plug into a separate 15 amp grounded outlet only.

- Use of extension cords

Avoid using extension cords. If there are no alternatives, ensure that the cord is a UL listed 3-wire grounding type, rated 125 volts with a minimum current-carrying rating of 15 amps, number 14 or heavier wire.



- Use a 15 amp time delay fuse or a circuit breaker.
- Do not switch off by unplugging the power plug while it is operating. Press the OFF/ON pad to "OFF" before unplugging.

POWER SUPPLY

Time Delay Fuse : 15 Amps
Rated Voltage : 115V



• Socket Type



• Line Cord Plug

INSTALLATION BOX CONTENTS

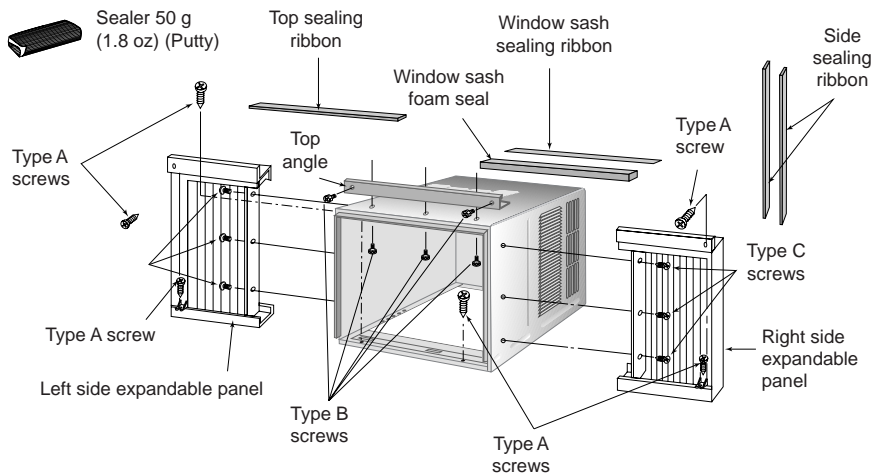

SCREW FURNISHED

Type A (Qty 6)	Type B (Qty 5)	Type C (Qty 6)
Wood Screw	Machine Screw	Tapping Screw

SUGGESTED TOOL LIST

	Medium sized screwdriver (#2 Phillips)
	Tape Measure
	Pencil
	Level
	Knife or Scissor

OPERATION PRECAUTIONS



WARNING This sign warns of risk of death or serious injury.



- Do not modify the length of the power cord or use an extension cord.

- Do not touch or operate with wet hands. Do not modify or damage the cord.

- Do not turn on the unit by inserting the power plug. Do not switch off the unit by pulling out the power plug.

- Avoid an extended period of direct airflow.

- Do not insert sticks, fingers or other objects into the unit.

- Do not try to repair the unit yourself.



- Plug in properly before operating and use a specified power cord.

- If abnormal conditions (burnt smell, etc) occur, switch off and remove the power plug.



CAUTION This sign warns of injury or damage to property.



- Do not use the unit for other purposes, than its intended use.

- Do not remove the power plug by pulling the cord.

- Do not block the air intake and outlet vanes.

- Do not splash or direct water at the unit.

- Do not expose the unit to direct sunlight during operation.

- Do not operate the unit without the air filter installed or when the front intake grille has been removed.

- Do not place any objects on the unit.

- Do not operate any combustion equipment near the unit's airflow area.



- Switch off the breaker and remove the power plug from the socket if the unit will not be operated for a long period.

- Pay attention to any damages on the unit caused by extensive usage.

- Ventilate the room occasionally where the unit is installed.

- Remove the power plug when cleaning the unit.

ACCESSORIES

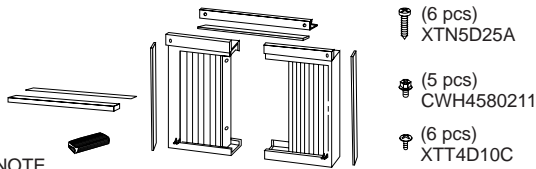

NOTE
 Check that none of the accessories are missing.

WINDOW REQUIREMENTS

- Hot sun rays hitting the outside surface of the cabinet will create considerable heat load. If the outside of the cabinet is exposed to direct sunlight, consider building an awning to shade the cabinet while providing ample area for the heated air to be exhausted from the condenser (both sides) and the top.

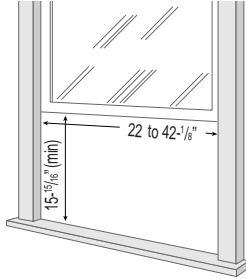

This unit is designed for installation in standard double hung windows.

NOTE
 The unit may also be installed "through the wall". You should, however, observe standard carpentry practices and frame the opening without violating local ordinances.

INSTALLATION PROCEDURES

- Remove the rear cabinet screws and save for later use.
- Slide the chassis out from the cabinet.

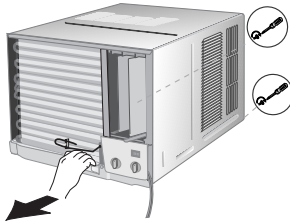

HOW TO ASSEMBLE THE EXPANDABLE PANELS

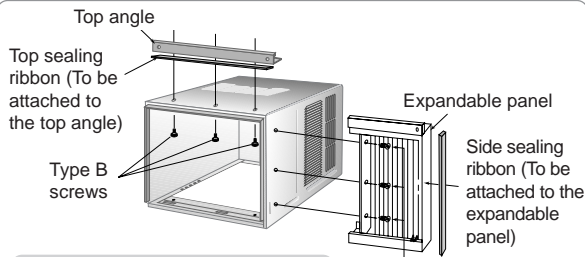

NOTE
 This procedure applies to left and right of assembling expandable panel.

- Attach the top angle to the cabinet using screw type B (3 pcs).
- Insert expandable panels to cabinet sides as shown.
- Secure the first fold of expansion panel to cabinet using screw type C (3 each).

SELECT THE BEST LOCATION

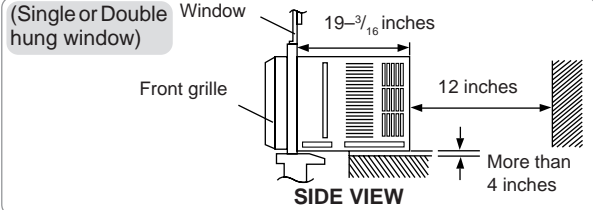

CABINET INSTALLATION

- Cut the "Sealing Ribbon" to the proper length, and attach it along the bottom edge of the bottom window sash.



- To prevent condensation water from dripping inside, the cabinet should be installed level or very slightly tilted to the outside.

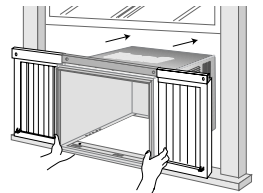

- Secure the cabinet using screws.

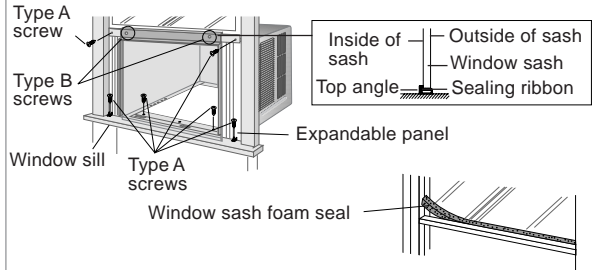

- Expand the expandable panel fully into the grooves of the window frame, secure the expandable panel, left, right and top mounting frames to the bottom of the window sash using 4 screws type A and 2 screws type B.
- Secure the cabinet using wood screws type A.
- Cut the window sash foam seal to the proper size and seal the opening between the top of the inside window sash and the outside window sash.

NOTE
 If a gap exists between the unit and window sash, you may use "Sealer" supplied with the installation kit for a better seal.

CHASSIS INSTALLATION INTO THE CABINET

- Slide the chassis into the cabinet.
- Reinstall the cabinet screws. Secure the cabinet to chassis by using screws (from rear cabinet).

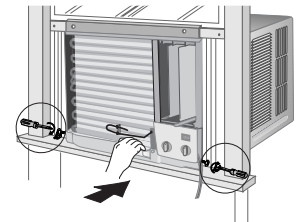

INSTALLATION OF THE FRONT GRILLE

Depending upon the location of the AC outlet, route the AC cord to either the left or right side while installing the front grille.

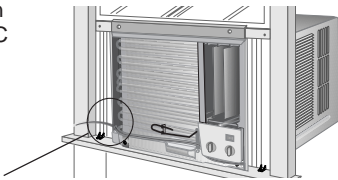

This figure shows the AC cord routed to the left side.

- 1 Place the front grille on the cabinet first.
- 2 Secure the front grille to the main chassis using screw provided.

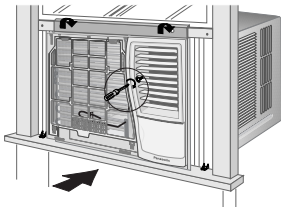

INSERT THE \mathcal{E} filter (OPTIONAL)

Attach the \mathcal{E} filter (part no. CZ-SF6P) to the frame.

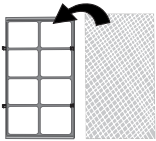

Slot in the \mathcal{E} filter and the frame (part no. CZ-SFW6P) to the front grille.

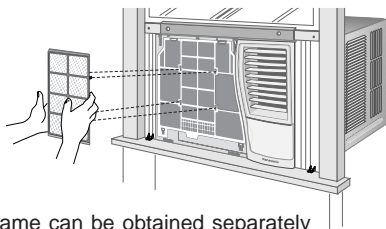

The \mathcal{E} filter and the frame can be obtained separately from your nearest servicer.

INSERT THE AIR FILTER

Attach the air filter to the intake grille.

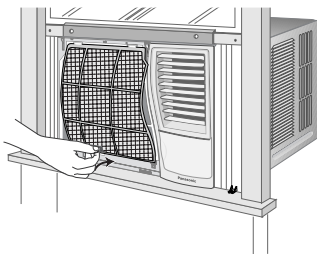

PLACE FRONT INTAKE GRILLE OVER THE FRONT GRILLE

Slide the front intake grille slightly to the right to reattach the tabs and then push it down to close tight.

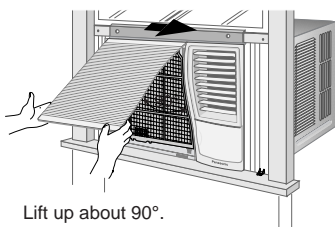

Lift up about 90°.

REMOVAL OF FRONT GRILLE

- 1 Remove the front intake grille.

Pull up the front intake grille about 90° and slide it slightly to the left to unhook the tabs.

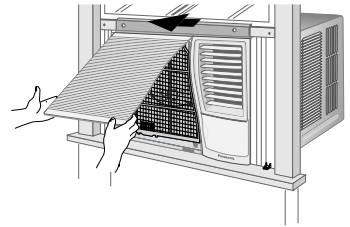

- 2 Remove the air filter.

Tilt up and pull out the air filter by the holder.

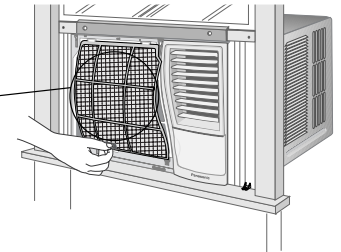
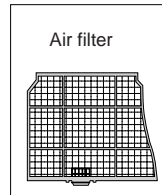

- 3 Remove the front grille.

a Remove the adhesive tape from all sides of the front grille.

b At bottom right side of the front grille, press inward on cabinet near the power cord, and pull the grille outward to the right until right tab releases.

c At the bottom left side, push inward on cabinet and pull the grille outward to the left to release the left tab. Do not pull the bottom edge toward you more than 3 inches to prevent the two top tabs from damage.

d Slide the front grille upwards to free the two top tabs from slots at the top of the cabinet.

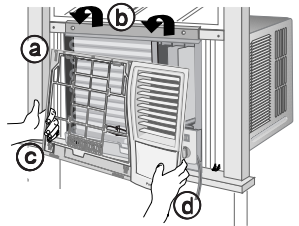

HOW TO ATTACH THE DRAIN PAN (OPTIONAL)

Condensed water drainage

This air conditioner employs a "Slinger-Up System" which is designed to splash the condensed water on the condenser coil for maximum cooling efficiency, thus producing a splashing sound. If the splashing sound annoys you, you can provide an outside drainage by using the following procedure which may, however, cause a small loss of performance.

NOTE

The cabinet should be installed tilted slightly lower to the rear for necessary condensate drainage. (Max. 13/32")

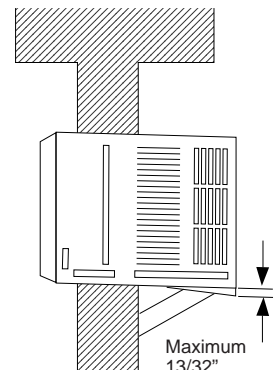

Condensed water

HOW TO ATTACH THE DRAIN PAN (OPTIONAL)

- ① Remove the rubber plug and slide the chassis out from the cabinet.

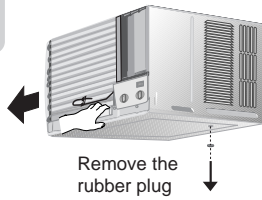

- ③ Connect a drain hose (optional).
Fit the drain hose to the drain pan.

NOTE
Drain hose or tubing can be purchased locally to satisfy your particular needs.

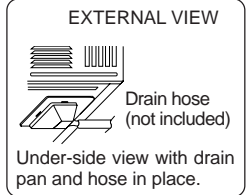

- ② Install the optional drain pan (part no. CWH40175).

Install the drain pan at the right corner of the cabinet using 2 screws (part no. CWG86C733).

NOTE
The drain pan (part no. CWH40175) can be obtained from nearest servicenter.

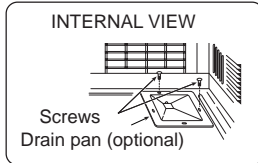

- ④ Slide the chassis back into the cabinet.
Reinstall the cabinet to chassis by using screws.

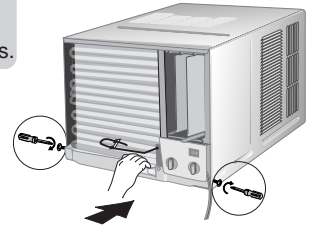

MAIN UNIT

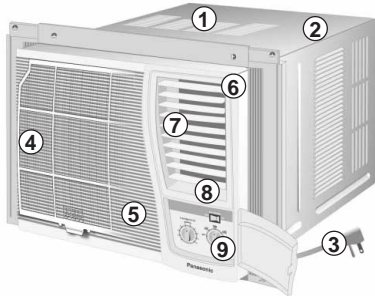

- ① Air inlet louver
- ② Cabinet
- ③ Power cord
- ④ Air filter
- ⑤ Front intake grille
- ⑥ Front grille
- ⑦ Vertical airflow direction vane
(Airflow direction adjustment up-down).
The vertical airflow direction vane is controlled by rotating the horizontal vane forward or backward.



- ⑧ Ventilation lever



CLOSE VENT OPEN

The ventilation lever must be in the CLOSE position in order to maintain the best cooling conditions. When fresh air is necessary in the room, set the ventilation lever to the OPEN position. The damper is opened and room air is drawn out.

- ⑨ Main control panel

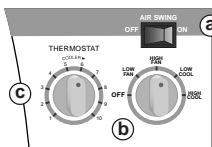

- a** Air Swing Switch
OFF Stops the operation of Air Swing.
ON Air Swing is in operation.
(Only for LOW COOL, MED COOL, HIGH COOL and ECONOMY operation.)



- b** Main Control Knob

High fan speed operation (without cooling) Low fan speed with cooling operation
Low fan speed operation (without cooling) Stops all operation High fan speed with cooling operation

- c** Thermostat Control Knob

For decreased cooling For increased cooling

① Open the control panel cover.



③ Thermostat Control Knob.

NOTE : Recommended setting

- For a room that is too warm, set the control knob to a clockwise direction.
- If the room is too cool, set the control knob to a counter clockwise direction.
- * Note : Usually 6~7 is the recommended setting position.

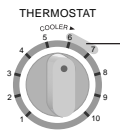

② Power Supply.

Switch off the breaker and set the main control knob to the OFF position; confirm that the power supply cord is connected to a proper AC outlet. < 115V, 60Hz >

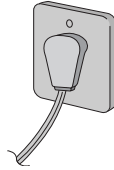

④ Air Swing Switch.

(Airflow direction adjustment Side-to-Side)
To obtain a fix airflow direction, set the air swing switch to "ON" for the vanes to swing from side to side until the desired flow direction is reached, then switch it to "OFF".
For continuous side-to-side air circulation, set the air swing switch to "ON".



Model		CW-C100VU	CW-C120VU	
COOLING CAPACITY	Btu/h	10,000	11,500	
ELECTRICAL RATING	Phase	Single	←	
	Frequency (Hz)	60	←	
	Voltage (V)	115	←	
	Current (Amps)	8.7	9.8	
	Input (W)	980	1120	
EER	(Btu/W.h)	10.2	←	
MOISTURE REMOVAL	(Pints/h)	2.5	3.0	
ROOM AIR CIRCULATION	(Cf/min)	320	330	
DIMENSIONS	Height	cm (inches)	37.5 (14. ⁻²⁵ / ₃₂ "	←
	Width	cm (inches)	56 (22. ⁻¹ / ₁₆ "	←
	Depth	cm (inches)	60.6 (23. ⁻²⁷ / ₃₂ "	←
NET WEIGHT	kg (lb)	35 (77)	←	
GROSS WEIGHT	kg (lb)	39 (86)	←	
NOISE LEVEL	Indoor (Hi/Lo)	dB (A)	50/46	51/47
	Outdoor (Hi/Lo)	dB (A)	57/54	58/55

* Specifications are subject to change without notice for further improvement.

ENERGY SAVING HINTS



- This may affect your well-being as well as increase power consumption.
- The cooling capacity of the room air conditioner must match the room size for efficient and satisfactory operation.
- Prevent hot air from entering and cool air from escaping.
- Ensure that curtains and drapes are always closed to keep out direct sunlight during cooling operation. Avoid heat.
- Clean the air filter every 2 weeks. Dirty filters may reduce cooling efficiency.

CARE AND MAINTENANCE**CAUTION**

Always turn off the air conditioner and the main power supply before clean the unit. Switch off the power supply if the unit is not going to be used for a long period of time.



- Clean the cabinet, front grille with a mild soap or detergent and lukewarm water.
- The front intake grille can be easily removed for cleaning purposes. Gently wash it with water and a sponge.
- The filter can be easily cleaned using a vacuum cleaner. Vacuum the front of the filter and then wash the rear with water. If it is badly soiled, wash with a mild household detergent.
It is recommended to replace the  filter (part no.CZ-SF6P) every 3 months.
- Do not clean with benzene, thinner, scouring powder or cloth soaked in caustic chemicals.
- If the unit is extremely dirty, heat transfer is less efficient and the unit may not cool effectively. Contact your nearest servicenter for an annual check.
- If the air filter becomes clogged with dust, the cooling capacity will drop, and 6% of the electricity used to operate the air conditioner will be wasted.

NOTE

Do not dry the front panel or the air filter in direct sunlight. (Exposure to direct sunlight may discolor or deform the panel.)

PRE-SEASON INSPECTION

- *Is the discharged air cold?*
After 15 minutes of operation, it is normal for the temperature difference between intake and outlet air to be more than 14.4°F for cooling.
- *Are the air intake and outlet vanes of the indoor and outdoor side obstructed?*

**RECOMMENDED INSPECTION**

- Usage over several seasons will reduce performance as the unit becomes dirty.
A dirty unit may produce foul odors and dust may clog the dehumidifying drainage.
Seasonal inspection is recommended in addition to regular cleaning. Consult your nearest servicenter.

BEFORE

Check the following points before calling for repairs or service. If the malfunction persists, please contact your nearest servicenter. For assistance, please call: 1-800-211-PANA (7262) or send e-mail to: consumerproducts@panasonic.com

POSSIBLE CAUSES OF THE ABOVE PROBLEMS

Condition ① If the unit is too noisy during operation.

The following sounds are normal during operation:

- A low humming sound indicating that the unit is operating.
- A soft clicking sound when the compressor turns on and off.
- A flowing sound due to circulation of the refrigerant when the compressor is turned on.
- A splashing sound indicating condensation in the condenser coil.

If you hear other noises, please consult your nearest servicenter.

Condition ② If the unit does not operate.

- The main power cord is not plugged in.
- The internal fuse has blown.
- The main circuit breaker has tripped.

Condition ③ If the unit does not cool properly.

- The room is too big for the unit's cooling capacity.
- The ventilation lever is set to OPEN.
- The air circulation is impeded by curtains or furniture.
- After 15 minutes of operation, it is normal for the temperature difference between intake and outlet air to be more than 14.4°F for cooling.

Condition ④ If water drips off the rear of the unit.

- Humidity is high.
- Condensed water is overflowing.
- To rectify the problem, mount a drain pan to the unit.

Condition ⑤ If water drips inside the room.

- The unit is tilted inward. To rectify this, tilt the unit slightly outward.
- Mount the optional drain pan if you prefer.
- The drain pan may be blocked.

If the trouble persists after you have checked all of these, call your authorized Panasonic dealer or servicenter. Service information can be obtained 24 hours/day by calling: 1-800-211-PANA (7262)

To expedite the repair of your air conditioner:

- Please have your proof of purchase.
- List all symptoms the unit is exhibiting.

**Panasonic Consumer Electronics Company,
Division of Matsushita Electric Corporation
of America**

One Panasonic Way
Secaucus, New Jersey 07094

**Panasonic Sales Company,
Division of Matsushita Electric of Puerto Rico, Inc.,**

Ave. 65 de Infanteria, Km. 9.5
San Gabriel Industrial Park
Carolina, Puerto Rico 00985

Panasonic Room Air Conditioner Limited Warranty

Panasonic Consumer Electronics Company or Panasonic Sales Company (collectively referred to as "the Warrantor") will repair this product with new or refurbished parts in case of defects in material or workmanship, free of charge, in the USA or Puerto Rico in accordance to the following (All time periods start from the date of the original purchase).

SEALED REFRIGERATING SYSTEM (compressor and interconnecting tube): FIVE (5) YEARS - PARTS AND LABOR

ALL OTHER COMPONENTS: ONE (1) YEAR - PARTS AND LABOR

In-home service in the USA can be obtained during the warranty period by contacting a Panasonic Service Company (PASC) Factory Servicenter listed in the Servicenter Directory. Or call toll free, 1-800-211-PANA(7262), to locate a PASC authorized Servicenter. In-home service in Puerto Rico can be obtained during the warranty period by calling the Panasonic Sales Company telephone number listed in the Servicenter Directory.

Note: If the unit is installed at the other than normal window height and/or has been custom-installed (e.g., through the wall), the customer is responsible for removing the unit from its installation prior to the performance of in-home service.

This warranty is extended only to the original purchaser. A purchase receipt or other proof of date of the original purchase is required for service and parts replacement under this warranty.

This warranty only covers failures due to defects in materials and workmanship and does not cover normal wear or cosmetic damage. The warranty does not cover damages which occur in shipment, or failures which are caused by products not supplied by the warrantor, or failures which result from accident, misuse, abuse, neglect, mishandling, misapplication, faulty installation, maladjustment of customer controls, improper maintenance, alteration, modification, power line surge, lightning damage, improper voltage supply, commercial use such as hotel, office, restaurant, or other business or rental use of the product, or service by anyone other than a PASC Factory Servicenter or a PASC authorized Servicenter, or damage that is attributable to acts of God.

LIMITS AND EXCLUSIONS

There are no express warranties except as listed above.

THE WARRANTOR SHALL NOT BE LIABLE FOR INCIDENTAL OR CONSEQUENTIAL DAMAGES RESULTING FROM THE USE OF THIS PRODUCT, OR ARISING OUT OF ANY BREACH OF THIS WARRANTY. ALL EXPRESS AND IMPLIED WARRANTIES, INCLUDING THE WARRANTIES OF MERCHANTABILITY, ARE LIMITED TO THE APPLICABLE WARRANTY PERIOD SET FORTH ABOVE.

Some states do not allow the exclusion or limitation of incidental or consequential damages, or limitations on how long an implied warranty lasts, so the above exclusions or limitations may not apply to you.

This warranty gives you specific legal rights and you may also have other rights which vary from state to state. If a problem with this product develops during or after the warranty period, you may contact your dealer or Servicenter. If the problem is not handled to your satisfaction, then write to the Consumer Affairs Department at the company address indicated above.

SERVICE CALLS WHICH DO NOT INVOLVE DEFECTIVE MATERIALS OR WORKMANSHIP AS DETERMINED BY THE WARRANTOR, IN ITS SOLE DISCRETION, ARE NOT COVERED. COSTS OF SUCH SERVICE CALLS ARE THE RESPONSIBILITY OF THE PURCHASER.

[For assistance, please call: 1-800-211-PANA (7262) or send e-mail to consumerproducts@panasonic.com]

Panasonic

ACONDICIONADOR DE AIRE

INSTRUCCIONES DE USO

ESPAÑOL

MODELO: CW-C100VU
CW-C120VU





Lea estas instrucciones detenidamente antes de utilizar el aparato de aire acondicionado, y guárdelas como referencia para el futuro.

Para solicitar asistencia llame al teléfono al cliente 1-800-211-PANA (7262) o envíe un correo electrónico a consumerproducts@panasonic.com o consulte nuestra página web www.panasonic.com

Cumpla con estas instrucciones de seguridad al utilizar el aparato de aire acondicionado.

- El incumplimiento de estas precauciones de seguridad o un uso negligente podrían causar incendios, descargas eléctricas o lesiones personales.

 Este símbolo (con un fondo blanco) indica una acción **PROHIBIDA**.

 Estos símbolos (con un fondo azul) indican acciones **OBLIGATORIAS**.

PRECAUCIONES DE INSTALACIÓN

- Debido al peso de este del aparato, se recomienda que solicite ayuda para su instalación. Para evitar posibles lesiones, utilice un método de elevación adecuado. Evite los bordes cortantes.
- Asegúrese de que el marco de la ventana puede soportar puede soportar este aparato este aparato.
- Este producto debe instalarse de acuerdo con las normativas, códigos y ordenanzas locales.
- No instale el aparato en lugares donde puedan generarse gases inflamables o humos.

PRECAUCIONES DE USO

- Conecte el este aparato de aire acondicionado a una alimentación estable de 115 voltios.
- Conéctelo a una toma de 15 amperios con toma de tierra.
- No utilice alargaderas.
Si no dispone de otra alternativa, asegúrese de que el cable es de tipo UL de 3 hilos y toma de tierra, de 125 voltios con un mínimo de 15 amp, número 14 o superior.
- Utilice una fusible con retardo de tiempo de 15 amp o un cortacircuitos.
- No desconecte el aparato tirando del enchufe mientras esté en funcionamiento. Sitúe el botón OFF/ON en "OFF" antes de desenchufar.

ALIMENTACIÓN DE CORRIENTE

Fusible con retardo de tiempo
: 15 Amp
Voltaje nominal: 115V



• Tipo de conexión • Cable con enchufe

CONTENIDOS DE LA CAJA DE INSTALACIÓN

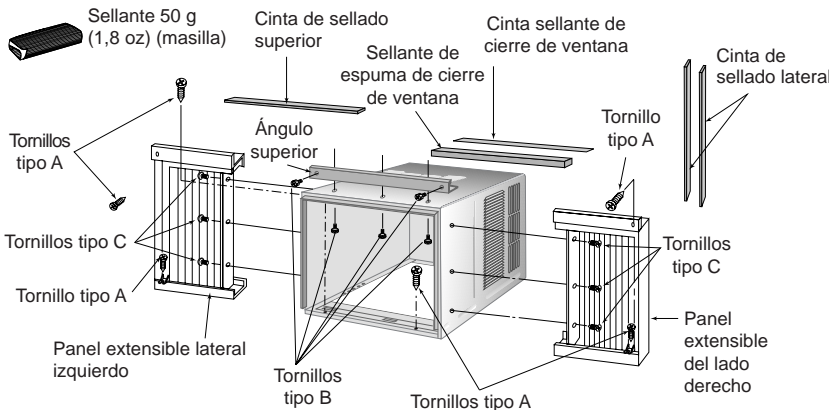

TORNILLOS INCLUIDOS

Tipo A (Cant. 6)	Tipo B (Cant. 5)	Tipo C (Cant. 6)
Tornillo para madera	Tornillo de máquina	Rosca para madera

LISTA DE HERRAMIENTAS SUGERIDAS

- Destornillador de tamaño medio (no.2 Phillips)
- Cinta de métrica
- Lápiz
- Nivel
- Cúter o tijera

PRECAUCIONES DE USO

 **PRECAUCIÓN** Este símbolo indica peligro de muerte o de lesiones graves.

- No modifique la longitud el cable de conexión ni utilice alargaderas.
- No toque ni utilice el aparato con las manos mojadas. No modifique o dañe el cable.
- No ponga en funcionamiento el equipo introduciendo el enchufe. No apague el aparato de aire acondicionado tirando del cable.
- Evite un periodo amplio de exposición al flujo directo de aire.
- No introduzca palos, los dedos u otros objetos en el equipo.
- No intente reparar el aparato usted mismo.
- Enchúfelo correctamente antes ponerlo en marcha y utilice un cable del tipo especificado.
- Si se producen condiciones anormales, (olor a quemado, etc.) apague el aire acondicionado y desenchúfelo de la red.

 **AVISO** Esta símbolo indica posibles lesiones o daños materiales.

- No utilice este aparato para fines para los que no ha sido diseñado.
- No desenchufe el aparato tirando del cable.
- No bloquee las entradas de aire o rejillas de salida.
- Evite verter o salpicar agua sobre el aparato.
- No lo exponga a la luz solar directa.
- No lo ponga en funcionamiento con el filtro de aire desmontado o cuando se haya retirado la rejilla frontal.
- No coloque ningún objeto sobre el aparato.
- No utilice ningún equipo de combustión junto al área de flujo de aire del equipo.
- Desconecte el disyuntor y desenchufe el aparato de la red si no va a utilizarlo durante un periodo prolongado de tiempo.
- Preste atención a cualquier daño observador en el equipo por un uso intensivo.
- Ventile la habitación ocasionalmente.
- Desenchufe al aparato de la red antes de proceder a su limpieza.

ACCESORIOS

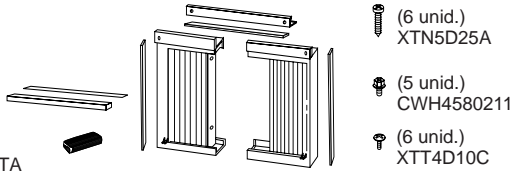

NOTA
Comprobar que no falta ningún accesorio.

REQUISITOS DE LA VENTANA

- Los rayos solares que inciden en la ventana crean una carga de calor considerable. Si el exterior del armario se expone a la luz solar directa, se recomienda proteger el armario con un toldo y disponer de un área amplia para el aire caliente que se expulsa desde el condensador (ambos lados) y de la parte superior.

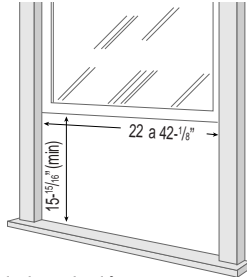

El aparato ha sido diseñado para la instalación en ventanas de guillotina doble.

NOTA

El aparato también puede instalarse en la pared. Sin embargo, se deberá cumplir con las normas estándar de la carpintería y el marco de la apertura sin violar las ordenanzas locales.

PROCEDIMIENTOS DE INSTALACIÓN

- Afloje los tornillos del armario trasero y guárdelos para su uso posterior.
- Deslice el chasis fuera del armario.

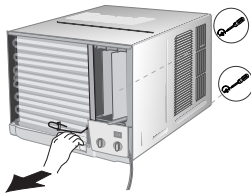

MONTAJE DE LOS PANELES EXTENSIBLES

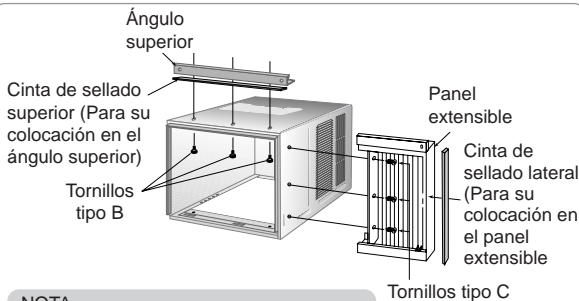

NOTA
Este procedimiento se aplica a derecha e izquierda del panel extensible de montaje.

- Una el ángulo superior al armario usando tornillos del tipo B (3 unidades).
- Introduzca los paneles extensibles en los lados del armario según se muestra en la figura.
- Fije la primera parte del panel de extensible al armario con el tipo de tornillo C (3 cada uno).

SELECCIONE LA MEJOR UBICACIÓN

(Ventalla de Ventana de guillotina sencilla o doble)

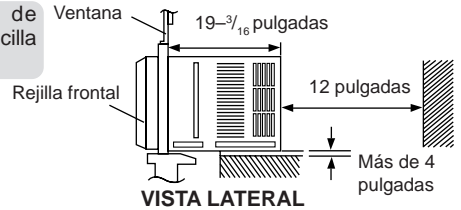

INSTALACIÓN DEL ARMARIO

- Corte la cinta sellante a la longitud adecuada y colóquela a lo largo del borde inferior del marco inferior.



- Para evitar que gotee en el interior el agua de condensación, instale el armario a nivel o ligeramente inclinado hacia el exterior.

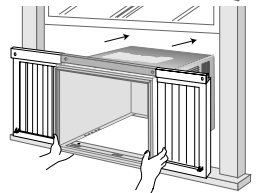

- Fije el armario con los tornillos.

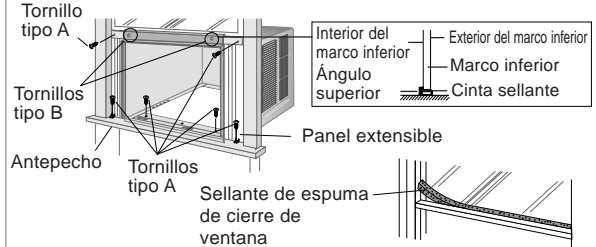

- Abra el panel extensible completamente hasta que las ranuras del marco de la ventana. Fije los marcos de montaje izquierdo, derecho y superior al marco inferior de la ventana usando 4 tornillos de tipo A y dos tornillos de tipo B.
- Fije el armario usando tornillos para madera de tipo A.
- Corte el sellante de espuma del marco de la ventana al tamaño adecuado y selle la abertura entre la parte interior del marco inferior del interior de la ventana y el marco inferior del lado exterior.

NOTA

En caso de existir un espacio entre la ventana y el marco inferior, utilice el sellante incluido en el kit de instalación para lograr un mejor sellado.

INSTALACIÓN DEL CHASIS EN EL ARMARIO

- Deslice el chasis en el armario.
- Vuelve a colocar los tornillos del armario. Fije el armario al chasis con los tornillos (del armario trasero).

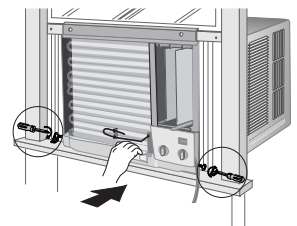

INSTALACIÓN DE LA REJILLA FRONTAL

Dependiendo de la ubicación de la toma de corriente, dirija el cable a través del lado derecho o izquierdo durante la instalación de la rejilla frontal.

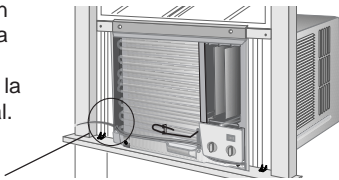

Esta figura muestra el cable dirigido por el lado izquierdo.

- ① En primer lugar, coloque la rejilla en el armario.
- ② Fije la rejilla frontal al chasis principal usando el tornillo que se incluye.

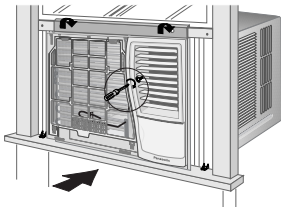

INTRODUZCA EL FILTRO e+filter (OPCIONAL)

Monte el filtro e+filter (parte no. CZ-SF6P) en el marco.

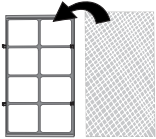

Fije el filtro e+filter al marco (parte no. CZ-SFW6P) a la rejilla frontal.

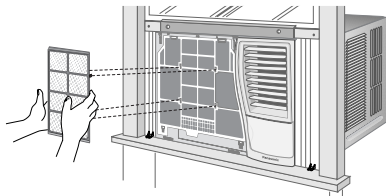

El filtro e+filter y el marco se pueden comprar por separado en su distribuidor autorizado.

INTRODUZCA EL FILTRO DE AIRE

Monte el filtro de aire en la rejilla de entrada ligeramente hacia la derecha para volver a colocar las pestañas y presione hacia abajo para cerrar.

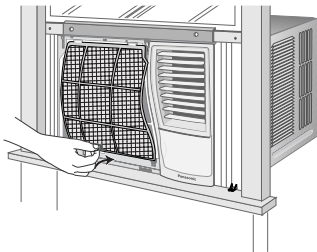

COLOCAR LA REJILLA DELANTERA DE ENTRADA SOBRE LA PARRILLA DELANTERA

Levantar aproximadamente la rejilla frontal hacia la derecha para volver a colocar las pestañas.

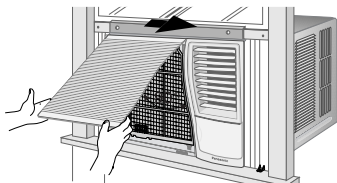

Elevar aproximadamente 90°.

CÓMO RETIRAR LA REJILLA FRONTAL

① Desmontaje de la rejilla frontal de entrada.

Tire hacia arriba de la rejilla de entrada aproximadamente 90°.

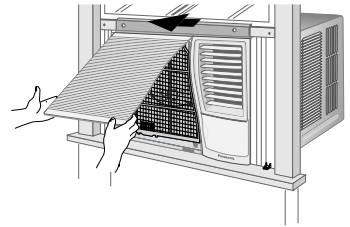

② Suelte el filtro de aire.

Levante y tire del soporte del filtro de aire.

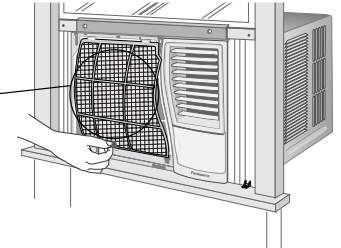
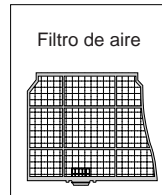

③ Cómo desmontar la rejilla frontal.

- a) Retire la cinta adhesiva de todos los lados de la rejilla frontal.
- b) En el lado inferior derecho de la rejilla frontal, junto al cable de conexión, presione hacia dentro, y tire de la rejilla hacia fuera, hacia la derecha, hasta que se suelte la pestaña derecha.
- c) En el lado inferior izquierdo, presione hacia dentro, y tire de la rejilla hacia fuera a la izquierda para soltar la pestaña izquierda.
- d) Deslice la rejilla frontal hacia arriba para liberar las dos pestañas superiores de las ranuras de la parte superior del armario.

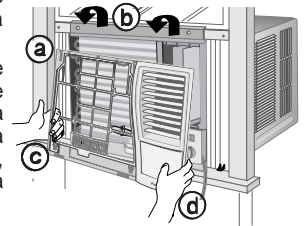

MODO DE COLOCACIÓN DE LA BANDEJA DE DRENAJE (OPCIONAL)

Drenaje de agua condensada

Este aparato de aire acondicionado utiliza un sistema "Slinger-Up" que ha sido diseñado para salpicar el agua del condensador en el serpentín del condensador para lograr la máxima eficacia de refrigeración, produciendo un sonido de salpicadura. En caso de resultar molesto dicho sonido, dispone de un drenaje exterior utilizando el procedimiento siguiente que, sin embargo, puede causar pequeñas pérdidas de rendimiento.

NOTA

Instale el armario ligeramente inclinado hacia atrás para lograr el drenaje de la condensación. (Máx: 13/32")

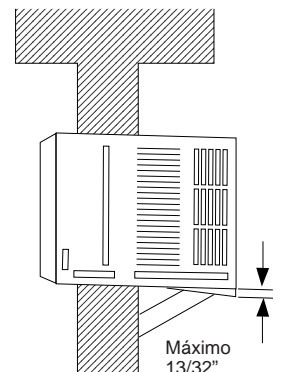

Agua condensada

MODO DE COLOCACIÓN DE LA BANDEJA DE DRENAJE (OPCIONAL)

① Retire el tapón de goma y deslice el chasis hacia fuera.



③ Conecte una manguera de drenaje (opcional)

Coloque la manguera de drenaje en la bandeja de drenaje.

NOTA
El tubo o la manguera de drenaje se puede comprar en el comercio de acuerdo a sus necesidades particulares.

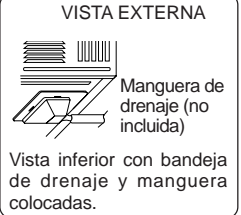

② Instale la bandeja opcional de drenaje (parte no. CWH40175).

Instale la bandeja de drenaje en el extremo derecho del armario usando 2 tornillos (parte no. CWG86C733).

NOTA
La bandeja de drenaje (parte no. CWH40175) la puede adquirir en su servicio técnico más cercano.

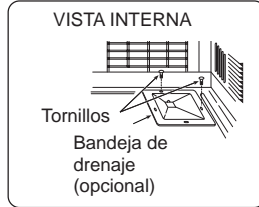

④ Deslice el chasis hacia atrás.

Vuelva a colocar los tornillos. Fije el armario al chasis usando tornillos.

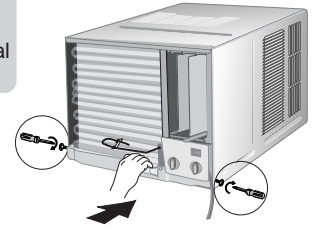

UNIDAD PRINCIPAL

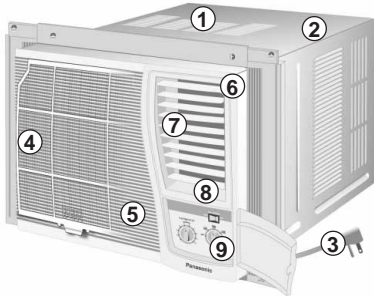

- ① Persiana de entrada de aire
- ② Armario
- ③ Cable de conexión
- ④ Filtro de aire
- ⑤ Rejilla de entrada frontal
- ⑥ Rejilla frontal
- ⑦ Persiana de dirección vertical de flujo de aire (ajuste arriba-debajo del flujo de aire)

La persiana de dirección de flujo de aire vertical se controla girando la persiana horizontal adelante y atrás.



⑧ Palanca de ventilación



CLOSE VENT OPEN

La palanca de ventilación no debe estar nunca en la posición CLOSE (cerrado) para mantener las mejores condiciones de refrigeración. Cuando necesite aire fresco en la habitación, ponga la palanca de ventilación en la posición OPEN (abierto). Entonces se abre la puerta y se expulsa el aire de la habitación.

⑨ Panel de control principal

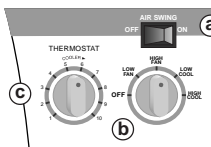

a) Interruptor de dirección del aire

OFF Detiene el funcionamiento de la dirección del aire.
ON Dirección del aire en funcionamiento.
(Sólo para funcionamiento LOW COOL, MED COOL, HIGH COOL y ECONOMY.)



b) Perilla del Control Principal

Funcionamiento de velocidad alta de ventilador (sin refrigeración)

Funcionamiento de velocidad baja de ventilador (sin refrigeración)

Detiene todo el funcionamiento

Funcionamiento de velocidad baja de ventilador con refrigeración

Funcionamiento de velocidad alta de ventilador con refrigeración

c) Botón de control del termostato

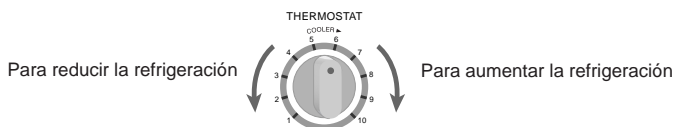

① Abra la tapa del panel de control.

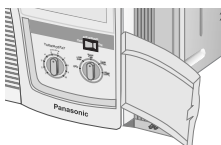

③ Botón de control del termostato.

NOTA : Posición recomendada

- Para una habitación demasiado caliente, gire el botón de control en la dirección de las agujas del reloj.
- Si la habitación está demasiado fría, gire el botón de control en la dirección opuesta.
- * Nota: Generalmente se recomienda la posición 6-7.

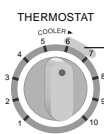

② Alimentación de corriente.

Desconecte el disyuntor y ponga el botón de control principal en la posición OFF; confirme que el cable de alimentación está conectado a un toma de corriente AC adecuada. < 115V, 60Hz >

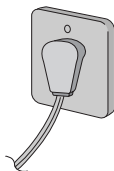

④ Interruptor de ajuste del aire.

(Ajuste lado a lado de la dirección del flujo del aire)

Para obtener una dirección fija del flujo del aire, ponga el interruptor en "ON" para las aletas que oscilan de un lado a otro hasta que lograr la dirección deseada, y pulse entonces "OFF". Para una circulación continuada del aire de lado a lado, ponga el interruptor en "ON".



Modelo		CW-C100VU	CW-C120VU	
CAPACIDAD DE REFRIGERACIÓN	Btu/h	10.000	11.500	
CARACTERÍSTICAS ELÉCTRICAS	Fase	Monofásico	←	
	Frecuencia (Hz)	60	←	
	Voltaje (V)	115	←	
	Corriente (Amps)	8,7	9,8	
	Entrada (W)	980	1120	
EER	(Btu/W.h)	10,2	←	
ELIMINACIÓN DE HUMEDAD	(Pints/h)	2,5	3,0	
CIRCULACIÓN DE AIRE EN LA HABITACIÓN	(Cf/min)	320	330	
DIMENSIONES	Altura	cm (pulgadas)	37,5 (14. ⁻²⁵ / ₃₂ "	←
	Anchura	cm (pulgadas)	56 (22. ⁻¹ / ₁₆ "	←
	Fondo	cm (pulgadas)	60,6 (23. ⁻²⁷ / ₃₂ "	←
PESO NETO	kg (lb)	35 (77)	←	
PESO BRUTO	kg (lb)	39 (86)	←	
NIVEL DE RUIDOS	Interior (Alto/bajo) dB (A)	50/46	51/47	
	Exterior (Alto/bajo) dB (A)	57/54	58/55	

* Las especificaciones están sujetas a cambio sin previo aviso.

CONSEJOS PARA EL AHORRO DE ENERGÍA

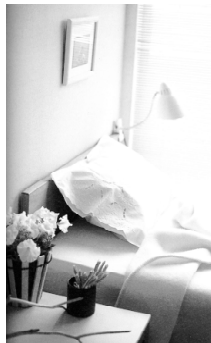

- Esto puede afectar a su bienestar, además de aumentar el consumo de energía.
- La capacidad de refrigeración del aparato de aire acondicionado debe corresponderse con el tamaño de la habitación para lograr una refrigeración satisfactoria.
- Evite la entrada de aire caliente y la salida de aire frío.
- Asegúrese de tener las cortinas siempre cerradas para evitar la luz solar directa durante la refrigeración. Evite el calor.
- Limpie el filtro cada 2 semanas. Los filtros sucios pueden reducir la eficacia de refrigeración.

CUIDADOS Y MANTENIMIENTO**AVISO**

Apague el aparato de aire acondicionado y desconéctelo de la red antes de limpiarlo. Asimismo, desconecte el aparato de la red si no va a utilizarlo durante un periodo prolongado de tiempo.



- Limpie el armario y la rejilla frontal con un jabón o detergente suaves o agua jabonosa.
- La rejilla frontal se desmonta con facilidad para su limpieza. Lávela con agua y una esponja.
- El filtro se puede limpiar con un aspirador. Limpie con el aspirador el frente del filtro y lave la parte posterior con agua. Si está muy sucio, lávelo con un jabón suave.
Se recomienda cambiar el **e**-filter (parte no. CZ-SF6P) cada 3 meses.
- No utilice para la limpieza benceno, disolvente o agentes químicos cáusticos.
- Si el aparato está muy sucio, la transferencia de calor es baja y puede afectar a la eficacia de la refrigeración. Póngase en contacto con un servicio técnico para la realización de una revisión anual.
- Si el filtro de aire se atasca con suciedad, se reducirá la capacidad de refrigeración y se estará malgastando un 6% del consumo de energía eléctrica.

NOTA

No seque el panel frontal o el filtro de aire exponiéndolos a la luz solar. (El panel puede decolorarse o deformarse).

INSPECCIÓN ANTES DE LA TEMPORADA DE USO

- *¿Se descarga aire frío?*
Tras 15 minutos de funcionamiento, es normal que la diferencia de temperatura entre el aire de entrada y el de salida sea superior a 14,4°F para la refrigeración.
- *¿Están las tomas y las salidas el lado interior y exterior obstruidas?*

**COMPROBACIÓN RECOMENDADA**

- El uso durante varias temporadas reducirá el rendimiento según se vaya ensuciando el aparato de aire acondicionado. Un aparato sucio puede producir olores extraños y el polvo puede obstruir el drenaje de deshumidificación. Se recomienda una revisión anual además de la limpieza regular. Póngase en contacto con su servicio técnico.

ANTES DE LLAMAR

Compruebe los puntos siguientes antes de solicitar reparaciones o mantenimiento. Si el fallo de funcionamiento persiste, póngase en contacto con un servicio técnico. Para solicitar asistencia llame al teléfono 1-800-211-PANA(7262) o envíe un correo electrónico a consumerproducts@panasonic.com

POSIBLES CAUSAS DE LOS PROBLEMAS CITADOS

Estado ① La unidad hace demasiado ruido durante el funcionamiento.

Los sonidos siguientes son normales durante el funcionamiento:

- Un pequeño ruido que indica que el aparato está en funcionamiento.
- Un ligero sonido de clic cuando el compresor se enciende y se apaga.
- Un sonido debido a la circulación de refrigerante cuando se enciende el compresor.
- Un sonido de salpicadura que indica la condensación en el serpentín del condensador.

Si oye otros ruidos, consulte a su servicio técnico.

Estado ② El aparato no funciona

- El cable no está correctamente enchufado en la toma de pared.
- Se ha fundido el fusible interno.
- El disyuntor principal ha saltado.

Estado ③ La unidad no enfría correctamente.

- El botón de control del termostato está colocado por debajo de 6.
- La palanca de ventilación está en OPEN.
- La circulación del aire se ve impedida por cortinas o mobiliario.
- Tras 15 minutos de funcionamiento, es normal que la diferencia de temperatura entre el aire de entrada y el de salida sea superior a 14,4°F para la refrigeración.

Estado ④ El agua gotea por la parte trasera del aparato.

- La humedad es alta.
- Rebosa el agua condensada.
- Para rectificar el problema, monte en la unidad una bandeja de drenaje.

Estado ⑤ El agua gotea en el interior de la habitación.

- El aparato está inclinado hacia dentro. Para rectificarlo, inclinarlo ligeramente hacia fuera.
- Monte la bandeja de drenaje si así lo prefiere.
- La bandeja de drenaje puede estar bloqueada.

Si persiste el problema tras haber realizado las citadas comprobaciones, póngase en contacto con su distribuidor Panasonic o un servicio técnico autorizado.

Puede solicitar asistencia en el teléfono de 24 horas: 1-800-211-PANA (7262)

Para agilizar la reparación del aparato de aire acondicionado:

- Tenga a mano el justificante de compra.
- Indique los síntomas que observa en el aparato.

**Panasonic Consumer Electronics Company,
Division of Matsushita Electric Corporation
of America**

One Panasonic Way
Secaucus, New Jersey 07094

**Panasonic Sales Company,
Division of Matsushita Electric of Puerto Rico, Inc.,**

Ave. 65 de Infanteria, Km. 9.5
San Gabriel Industrial Park
Carolina, Puerto Rico 00985

Panasonic Room Air Conditioner Limited Warranty

Panasonic Consumer Electronics Company or Panasonic Sales Company (collectively referred to as "the Warrantor") will repair this product with new or refurbished parts in case of defects in material or workmanship, free of charge, in the USA or Puerto Rico in accordance to the following (All time periods start from the date of the original purchase).

SEALED REFRIGERATING SYSTEM (compressor and interconnecting tube): FIVE (5) YEARS - PARTS AND LABOR

ALL OTHER COMPONENTS: ONE (1) YEAR - PARTS AND LABOR

In-home service in the USA can be obtained during the warranty period by contacting a Panasonic Service Company (PASC) Factory Servicenter listed in the Servicenter Directory. Or call toll free, 1-800-211-PANA(7262), to locate a PASC authorized Servicenter. In-home service in Puerto Rico can be obtained during the warranty period by calling the Panasonic Sales Company telephone number listed in the Servicenter Directory.

Note: If the unit is installed at the other than normal window height and/or has been custom-installed (e.g., through the wall), the customer is responsible for removing the unit from its installation prior to the performance of in-home service.

This warranty is extended only to the original purchaser. A purchase receipt or other proof of date of the original purchase is required for service and parts replacement under this warranty.

This warranty only covers failures due to defects in materials and workmanship and does not cover normal wear or cosmetic damage. The warranty does not cover damages which occur in shipment, or failures which are caused by products not supplied by the warrantor, or failures which result from accident, misuse, abuse, neglect, mishandling, misapplication, faulty installation, maladjustment of customer controls, improper maintenance, alteration, modification, power line surge, lightning damage, improper voltage supply, commercial use such as hotel, office, restaurant, or other business or rental use of the product, or service by anyone other than a PASC Factory Servicenter or a PASC authorized Servicenter, or damage that is attributable to acts of God.

LIMITS AND EXCLUSIONS

There are no express warranties except as listed above.

THE WARRANTOR SHALL NOT BE LIABLE FOR INCIDENTAL OR CONSEQUENTIAL DAMAGES RESULTING FROM THE USE OF THIS PRODUCT, OR ARISING OUT OF ANY BREACH OF THIS WARRANTY. ALL EXPRESS AND IMPLIED WARRANTIES, INCLUDING THE WARRANTIES OF MERCHANTABILITY, ARE LIMITED TO THE APPLICABLE WARRANTY PERIOD SET FORTH ABOVE.

Some states do not allow the exclusion or limitation of incidental or consequential damages, or limitations on how long an implied warranty lasts, so the above exclusions or limitations may not apply to you.

This warranty gives you specific legal rights and you may also have other rights which vary from state to state. If a problem with this product develops during or after the warranty period, you may contact your dealer or Servicenter. If the problem is not handled to your satisfaction, then write to the Consumer Affairs Department at the company address indicated above.

SERVICE CALLS WHICH DO NOT INVOLVE DEFECTIVE MATERIALS OR WORKMANSHIP AS DETERMINED BY THE WARRANTOR, IN ITS SOLE DISCRETION, ARE NOT COVERED. COSTS OF SUCH SERVICE CALLS ARE THE RESPONSIBILITY OF THE PURCHASER.

[For assistance, please call: 1-800-211-PANA (7262) or send e-mail to consumerproducts@panasonic.com]

Free Manuals Download Website

<http://myh66.com>

<http://usermanuals.us>

<http://www.somanuals.com>

<http://www.4manuals.cc>

<http://www.manual-lib.com>

<http://www.404manual.com>

<http://www.luxmanual.com>

<http://aubethermostatmanual.com>

Golf course search by state

<http://golfingnear.com>

Email search by domain

<http://emailbydomain.com>

Auto manuals search

<http://auto.somanuals.com>

TV manuals search

<http://tv.somanuals.com>