

Operating Instructions

AUTO-LOGIC™

TELEPHONE-ANSWERING
SYSTEM WITH FACSIMILE

MODEL NO. **KX-F3500**

FACSIMILE

ANSWERING MACHINE

TELEPHONE

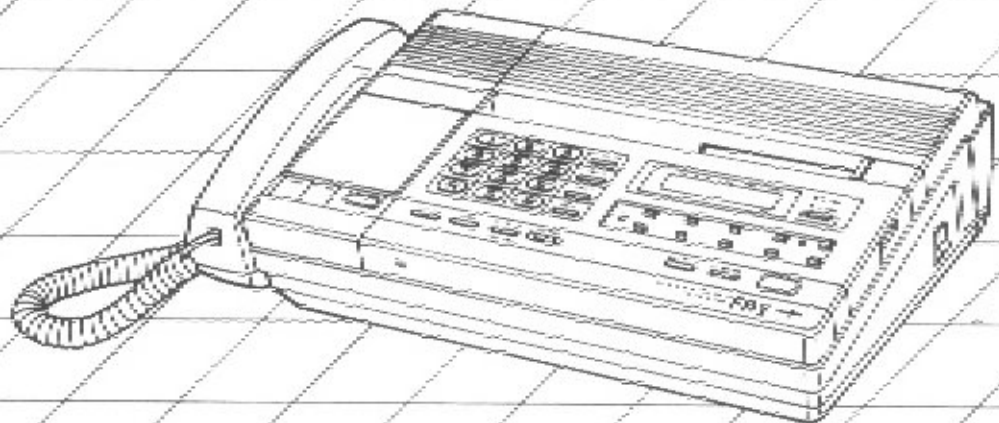

Panasonic

Please read before use.

Thank you for purchasing the Panasonic Telephone-Answering System with Facsimile.

Before reading these instructions, read the INSTALLATION MANUAL, then install the unit and make the initial settings.

Since this unit functions as a Facsimile, an Answering Machine and a Telephone utilizing one telephone line, you can receive both voice-messages and documents.

To Speak with the Other Party and then Transmit/Receive a Document

With the automatic telephone/facsimile switching feature, you can switch between telephone and facsimile functions without redialing. So, if you are in the middle of a conversation and want to transmit/receive a document, simply push the START/COPY button and facsimile transmission/reception will take place automatically.

To Record a Voice-Message and Receive a Document

The unit will automatically function as an Answering Machine or a Facsimile depending on the caller's choice (voice-message/document).

When a call is received during your absence, the unit will play your Outgoing Message (OGM) and then be ready to record a voice-message and/or receive a document (Automatic Answer Mode).

- In this mode you may speak with the other party and transmit/receive a document manually.

To Set the Automatic Answer Mode

- Push the AUTO ANSWER button to turn on the AUTO ANSWER indicator light.
- Record your Outgoing Message.
- Set the AUTO/FAX selector to "AUTO" position.

- If a caller wishes to transmit a document after recording a voice-message; advise the caller to "Push the ASTERISK (*) button after or during the playing of the Outgoing Message (OGM)", the unit will change from the answering machine mode to the facsimile mode.
- If a caller wishes to record a voice-message after transmitting a document; advise the caller to "Make a call reservation following a voice contact procedure on your facsimile during transmission". The unit will start playing the OGM again and then be able to record a voice-message.

Features

■ Multi-Function System utilizing Single Telephone Line

- allows you to speak with a caller and/or receive a document.
- automatically records a caller's message and/or receives a document during your absence.

■ Facsimile

- CCITT GII/GIII communication compatibility
- Automatic document feeder up to five pages at a time
- One-touch transmission with automatic dialer 10 (30 digits) fax numbers for one-touch dialing
- Superb image quality
- 16-step HALF-TONE feature for originals containing photographs, shaded drawings, etc.
- Up to letter size

■ Answering System

- Auto-logic™ operation
 - automatically rewinds, play back messages, stops at the last message and provides for answering the next call, at the touch of a button.
- Recordable OGM chip
- Beeperless remote control with tone phone

■ Integrated Telephone System

- Built-in speakerphone
- One-touch/speed dialing
- Automatic redialing up to 15 times in a hands-free (speakerphone) operation.

■ Copier Function

- Right at your desk
- Clear copy

AUTO/FAX Selector

● AUTO position

The unit will automatically switch between Answering Machine and Facsimile. If the caller's voice is not heard within 5 seconds of the end of the OGM, the unit will automatically switch to the FAX mode to receive a document. If the caller's voice is heard, the unit will function as an answering machine.

● FAX position

When a call is received, the unit will function as a facsimile (FAX) machine only.

Location of Controls

For your convenience, keep this page open when you read the following instructions.

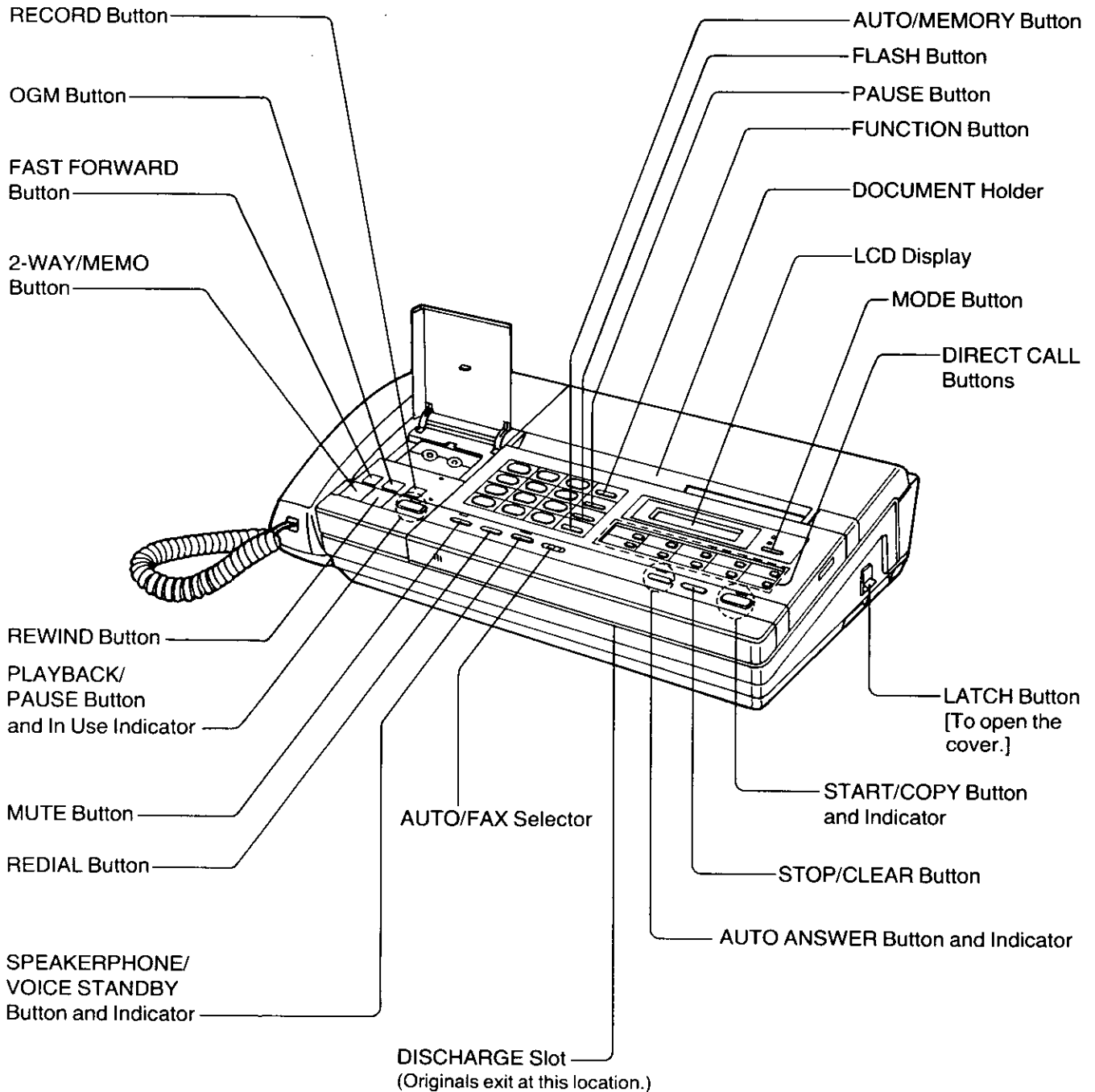

Location of Controls (cont.)

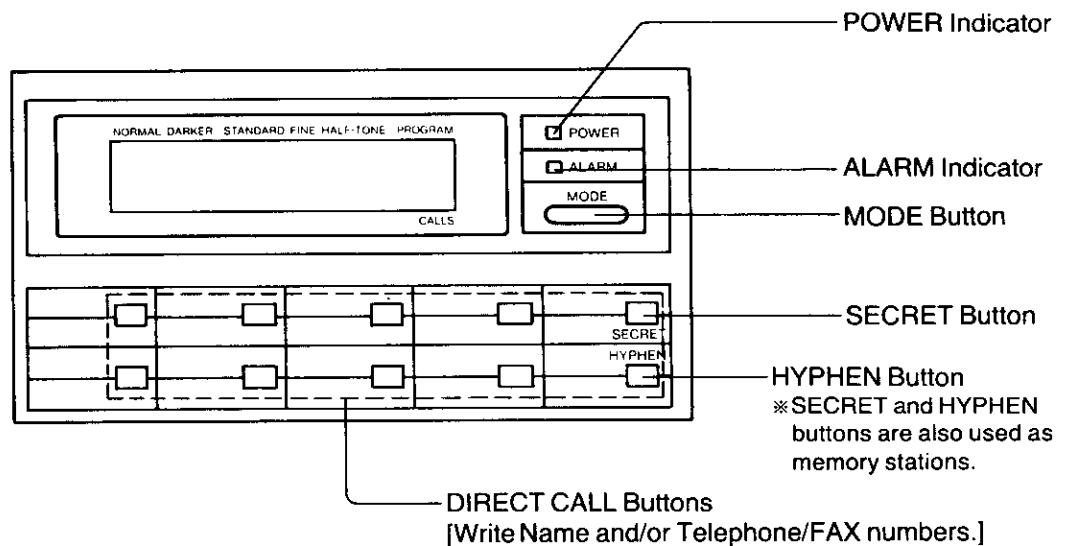
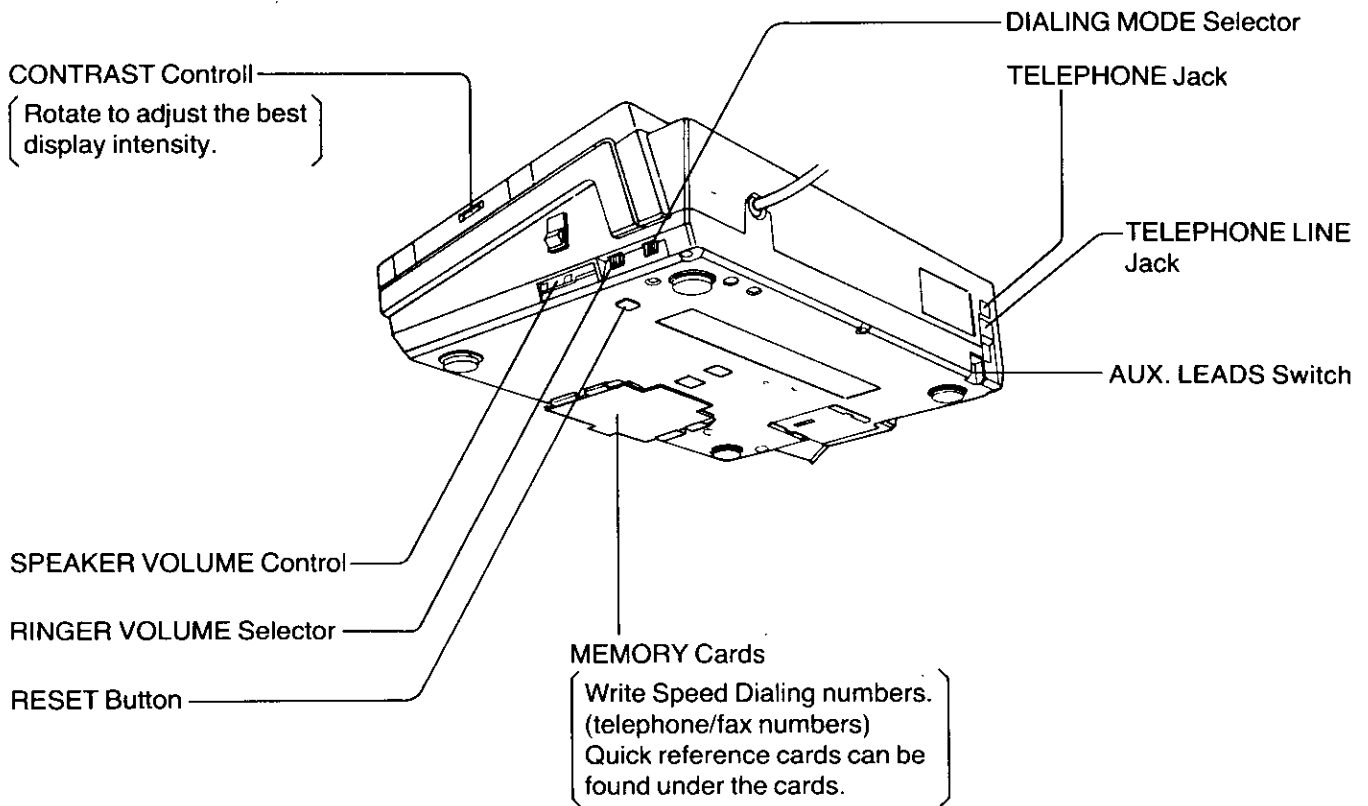

Accessories

Telephone Line Cord	1	Carrier Sheet	1
Incoming Message Tape	1	Document Tray	1
Handset	1	Document Tray Guide	1
Handset Cord	1	AA Size Batteries	4
Paper Shaft	1	Card Holder for Speed Dialing	1
Recording Paper	1		

Table of Contents

System Setup 5

FACSIMILE

Basic Operation

Manual Transmission and Reception 1-1

- Transmission
- Reception
- Scanning Line Density (Resolution)
- Document Contrast

Transmissible Document 1-4

- Information on Originals
- How to Use the Carrier Sheet

Automatic Document Reception 1-5

- Preparation
- Setting Up for Automatic Answering
- Receiving a Document

Detailed Operation

How to Transmit a Document

Conveniently 1-7

- When Using One-Touch Transmission
- When Using Speed Dialing

Voice Contact 1-9

- Initiating Voice Contact
During Transmission or Reception
- Receiving a Request for Contact

How to Operate Your Unit from a Remote Location 1-10

Other Informations 1-10

Delayed Transmission 1-11

Making a Copy 1-14

Individual Transmission Report 1-15

Activity Report (JOURNAL) 1-16

Printout Function 1-17

ANSWERING MACHINE

Preparing the Answering Machine 2-1

- Recording OGM
- Selecting the Caller's Recording Time
- Selecting the Remote Code No. for Remote Operation
- Setting Up the Automatic Answer Mode
- Preparing the ICM Tape

Operating the Answering Machine 2-4

- Playing Back Your Messages
- Call Counter
- Saving Your Messages
- Erasing the ICM
- Monitoring Incoming Calls
- Message Memo
- Recording a 2 Way Conversation

How to Operate from a Remote Phone .. 2-7

- Turning On the Automatic Answer Mode from a Remote Phone
- Playing Back Messages
- Memory Playback
- Back Space and Skip Forward
- Recording a Marker Message
- Remote Reset
- Skipping OGM for ICM Recording
- Turning On the Speakerphone (Answer Back)
- Changing the OGM

TELEPHONE

Manual Dialing and Reception 3-1

- Making a Call
- Receiving a Call
- Redialing

Switching to Hands-free or Handset

Operation during a Conversation 3-2

- Handset to Hands-free
- Hands-free to Handset

Speed Dialing and One-Touch Dialing .. 3-3

- Programming the Phone Numbers for Speed Dialing
- Programming the FAX/Phone Numbers for One-Touch Dialing
- Dialing

Other Features 3-6

- How to Store a Secret Phone Number
- Mute Operation
- Flash Button Usage
- Tone Button Usage
- Combination Dialing
- Outside Line or Computer Accessed Line (Pause Usage)

GENERAL INFORMATION

Recording Paper Installation 4-1

Troubleshooting Guide 4-2

Glossary of Terms 4-5

System Setup

There are 19 user programmable functions in the unit. After entering the Programming Mode by pushing the FUNCTION button, these functions may be selected or changed by pushing the REDIAL or MUTE button.

No.	FUNCTION	LCD DISPLAY	PAGE
01	Date and Time	1/ 1/88 12:00AM	See Example on page 6.
02	Logo and Sender's Identification	SENDER ID =	See page 10 in INSTALLATION MANUAL.
03	Delayed Transmission (XMT)	DELAYED XMT=OFF	See page 1-11.
04	Time of Delayed XMT	SEND AT 12:00AM	See page 1-11.
05	FAX No. of Delayed XMT	SEND TO	See page 1-12.
06	Remote ID for remote operation	REMOTE ID = 111	See page 2-2.
07	Caller's Recording Time	REC TIME = VOX	See page 2-1.
08	CPC (Calling Party Control) Mode	CPC MODE = A	See page 8 in INSTALLATION MANUAL.
09	Dial Speed for pulse dialing	DIAL SPEED = 10	See page 8 in INSTALLATION MANUAL.
10	Tone Detect	TONE DETECT=ON	See page 8 in INSTALLATION MANUAL.
11	Journal	JOURNAL=AUTO	See page 1-16.
12	Transmission (TX) Report	TX REPORT = OFF	See page 1-15.
13	Transmission (TX) Speed	TX SPEED = 9600	See page 8 in INSTALLATION MANUAL.
14	ID Position	ID POSITION=OUT	See page 8 in INSTALLATION MANUAL.
15	Motor Test	MOTOR TEST	See page 16 in INSTALLATION MANUAL.
16	Printer Test	PRINTER TEST	See page 16 in INSTALLATION MANUAL.
17	System Print	SYSTEM PRINT	See page 1-17.
18	Telephone No. List Print	TEL LIST PRINT	See page 1-17.
19	Journal Print	JOURNAL PRINT	See page 1-17.

System Setup

1 Push **FUNCTION**.

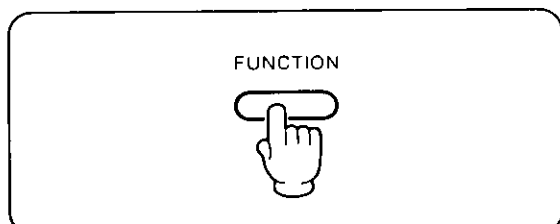

•The following message will be displayed.

SELECT COMMAND

2 Push **REDIAL** or **MUTE** until the desired message is displayed.

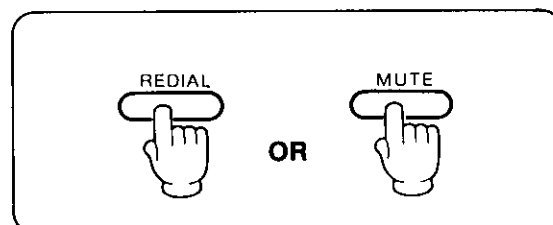

•By using the REDIAL button, the function is selected in the order of No. 01, 02, 03...19.
 •By using the MUTE button, the function is selected in the order of No. 19, 18, 17...01.

3 Proceed to each section.
 •Refer to page shown above.

System Setup (cont.)

Example: Apr. 15, 1988. 5:15 PM

1 Push **FUNCTION**.

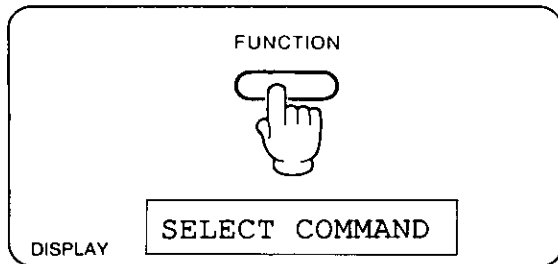

2 Push **REDIAL**.

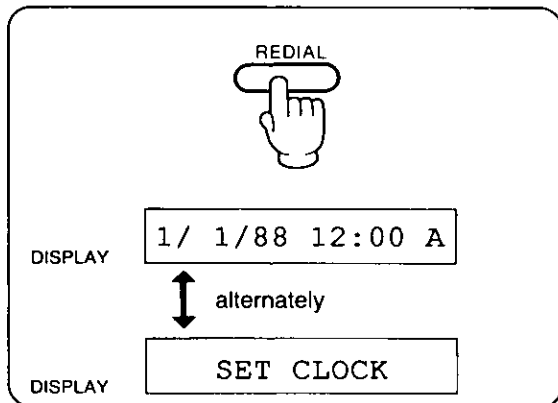

3 Enter the new clock setting in the format **MONTH/ DATE/YEAR/HOUR: MINUTE (2 digits each)/PM or AM.**

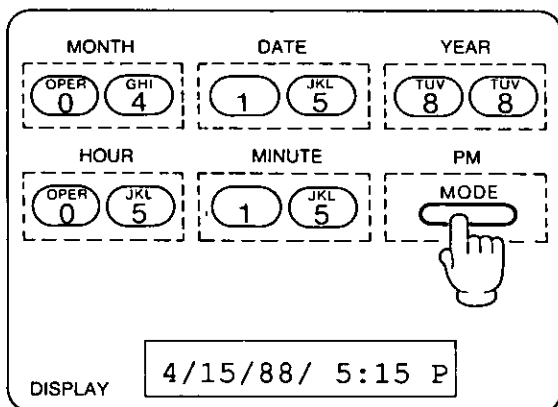

- Push the **MODE** button to select AM/PM mode. The display shows A (AM) or P (PM).
- Push "*" or "#" to move the cursor left or right respectively.

4 Push **AUTO/MEMORY**.

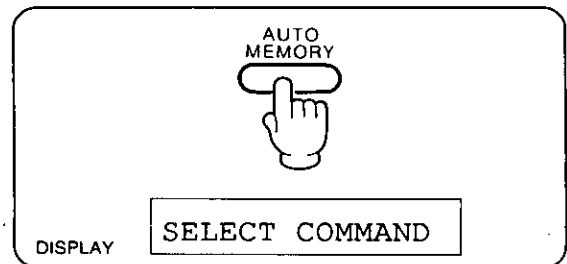

- After pushing the **AUTO/MEMORY** button, you may step to the next (or previous) function by pushing the **REDIAL** (or **MUTE**) button.

5 Push **FUNCTION** to end the operation.

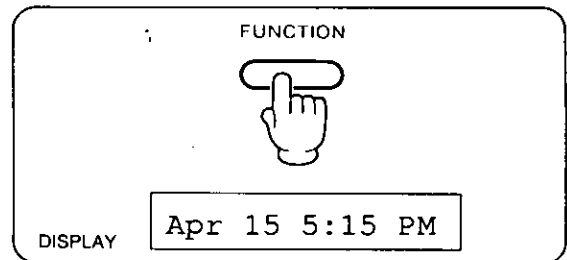

- The display will current time.

System Setup (cont.)

You can also select the desired function directly by pushing the “#” and code No. (01 through 19) instead of pushing the REDIAL or MUTE button.

Example: To select the CPC Mode directly

1 Push **FUNCTION**.

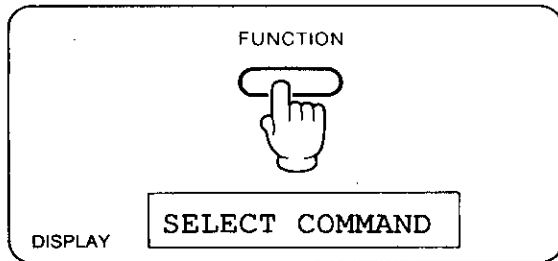

2 Push “#” and then “08”.

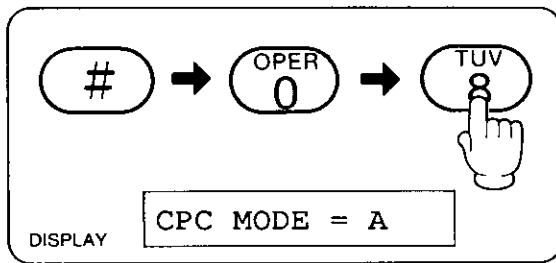

3 Push **MODE** if you want to change.

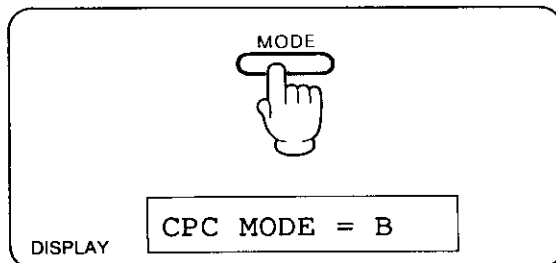

• “A” and “B” are changed alternately each time you push the **MODE** button.

4 Push **AUTO/MEMORY**.

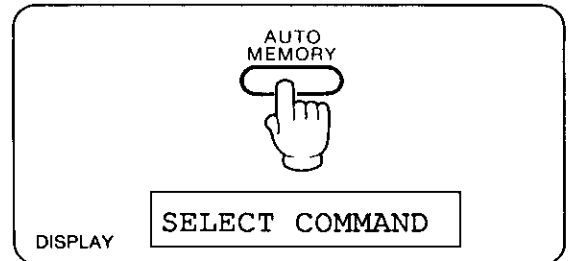

• After pushing the **AUTO/MEMORY** button, you may step to the next (or previous) function by pushing the **REDIAL** (or **MUTE**) button.

5 Push **FUNCTION** to end the operation.

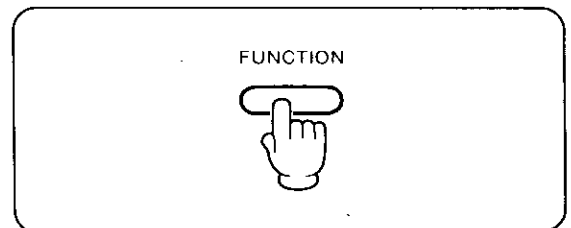

How to Operate as a Facsimile Machine

Table of Contents

Manual Transmission and Reception	1-1
Transmission	1-1
Reception	1-1
Scanning Line Density (Resolution)	1-2
Document Contrast	1-2
Transmissible Document	1-4
Information on Originals	1-4
How to Use the Carrier Sheet	1-4
Automatic Document Reception	1-5
Preparation	1-5
Setting Up for Automatic Answering	1-6
Receiving a Document	1-6
How to Transmit a Document Conveniently	1-7
When Using One-Touch Transmission	1-7
When Using Speed Dialing	1-8
Voice Contact	1-9
Initiating Voice Contact During Transmission or Reception	1-9
Receiving a Request for Contact	1-9
How to Operate Your Unit from a Remote Location	1-10
Other Informations	1-10
Delayed Transmission	1-11
Setting Up Delayed Transmission	1-11
Making a Copy	1-14
Individual Transmission Report	1-15
Activity Report (JOURNAL)	1-16
Printout Function	1-17

Manual Transmission and Reception

Transmission

- 1 Place the document face down.

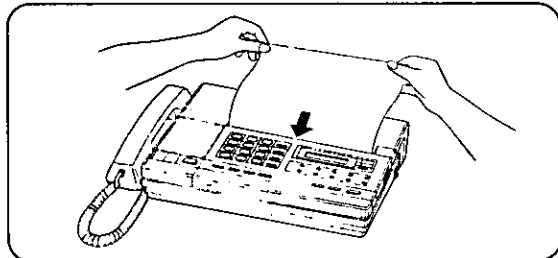

- 2 Lift the handset or push **SP-PHONE**, then dial the **FAX NO.**

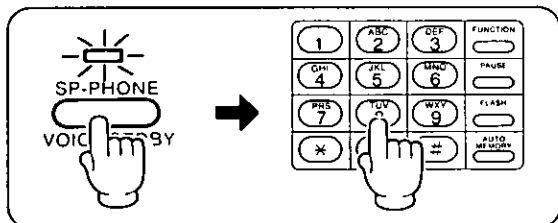

- 3 When the "Beep" (answering carrier tone) is heard, push **START/COPY**.

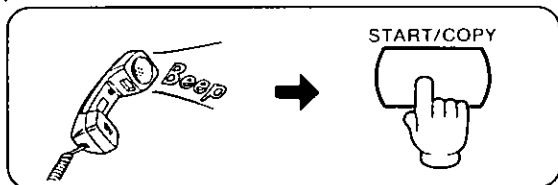

- 4 After pushing **START/COPY**, replace the handset.

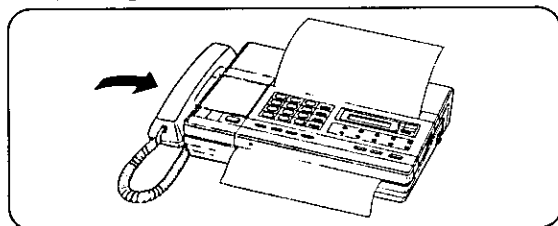

- During a fax transmission, the number of each page (99 max.) is displayed. (e.g. 5 pages are transmitted.)

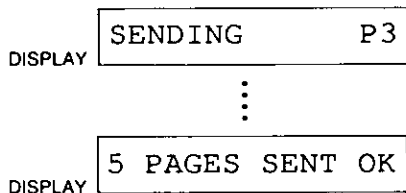

Reception

- 1 Lift the handset to speak to the caller.

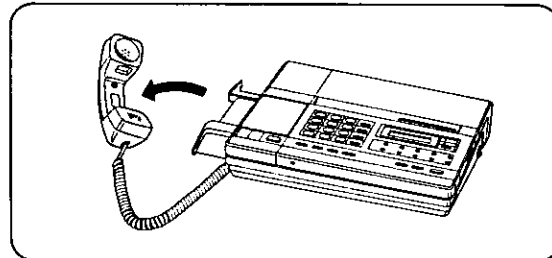

- 2 Push **START/COPY** to receive a document.

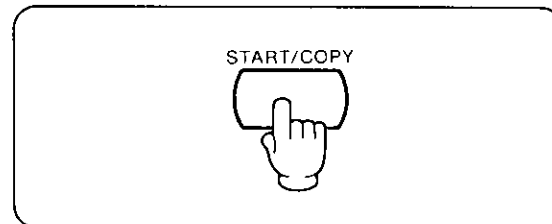

- 3 After pushing **START/COPY**, replace the handset.

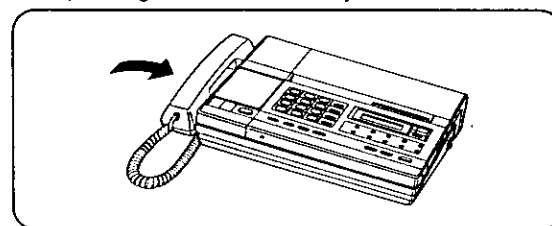

- During a fax reception, the number of each page (99 max.) is displayed.

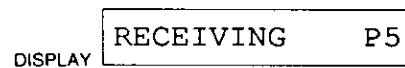

Manual Transmission and Reception (cont.)

Scanning Line Density (Resolution)

The resolution (density) of the received image (e.g. characters, pictures) can be set as shown below:

- 1 Push **MODE**.

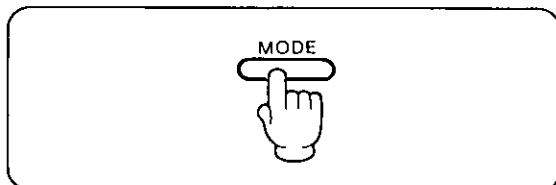

- Each mode is indicated by the "▲" symbol on the display.

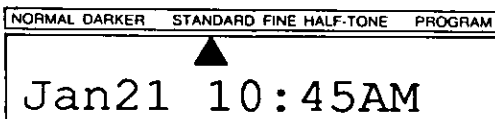

- **STANDARD** is suitable for printed or typewritten originals with normal size characters.
- **FINE** is suitable for originals written with small characters.
- **HALF-TONE** is suitable for originals containing photographs, shaded drawings and the like.

Information on Photographs and Drawings:

This unit is equipped with a 16-step HALF-TONE feature, which should be used when transmitting or copying originals containing photographs, shaded drawings, etc.

Document Contrast

The document contrast can be set as shown below.

- 1 Push **FUNCTION**.

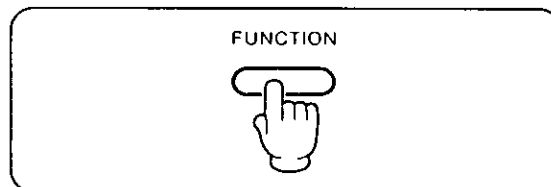

- 2 Push **MODE**.

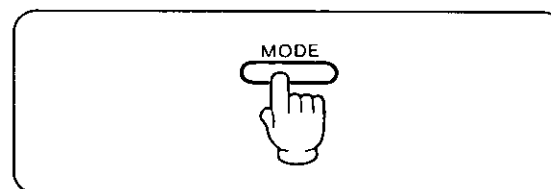

- Each mode is indicated by "▲" symbol on the display.

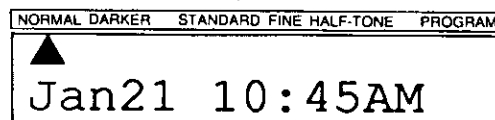

- **NORMAL** is suitable for transmitting or copying printed or typewritten documents.
- **DARKER** is suitable for transmitting or copying originals written in light pencil.

FACSIMILE

NOTES:

•START/COPY indicator:

The START/COPY indicator will change from a flashing to a steady light, and the unit will begin transmitting or receiving the document.

• If you are using the speakerphone, the line will be automatically disconnected after the transmission is completed.

• Begin by transmitting the FAX CORRESPONDENCE leaflet (included) to several of your business associates to confirm that your unit is functioning correctly, and to inform them of the procedure for transmitting documents and/or recording voice-messages on your unit.

• If you do not hang up the handset after transmitting, the unit will automatically call the other party.

For further details, see "Voice Contact" on page 1-9.

Manual Transmission and Reception (cont.)

■ To stop transmission:

- 1 Push down **STOP/CLEAR** firmly.

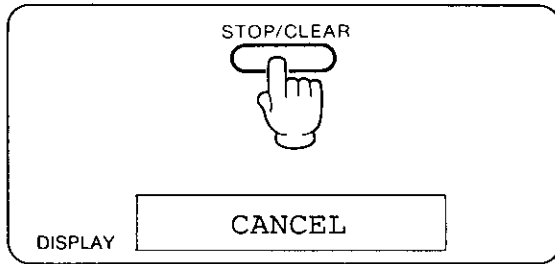

■ If a document jams during transmission:

- 1 Push **STOP/CLEAR** to stop transmission and then push **LATCH** to open the cover.

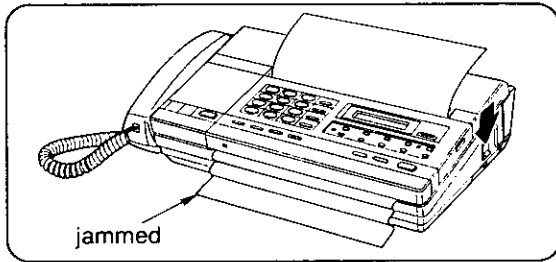

- 2 Pull out the document.

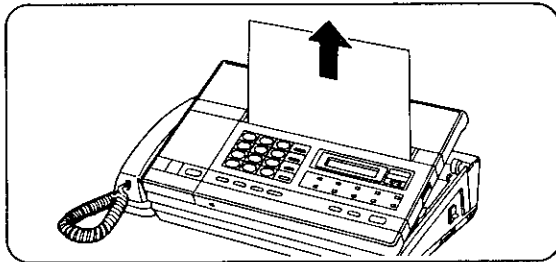

■ To transmit continuously: (Weight of document is 16 to 20 pounds.)

- 1 First insert a maximum of 5 pages.
- 2 Start the fax transmission.
- 3 Insert additional pages (5 sheet max.).
 - Insert additional pages when the last page disappears from the top of the DOCUMENT holder and while the START/COPY indicator is still lit.

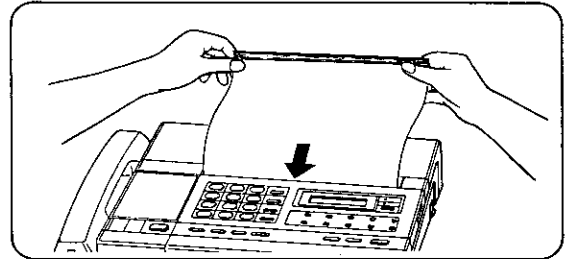

CAUTION:

When you set the documents, a beep will be heard. After hearing the beep, tight insertion of multiple documents, may cause simultaneous transmission of multiple documents.

■ To transmit continuously: (Weight of document is except 16 to 20 pounds.)

- 1 Transmit a document separately.
- 2 Insert additional page while hearing 4 beeps*.

*When the unit is ready to transmit a additional page, 4 beeps will be heard.

Transmissible Document

The unit can transmit documents with the following sizes, weights and textures.

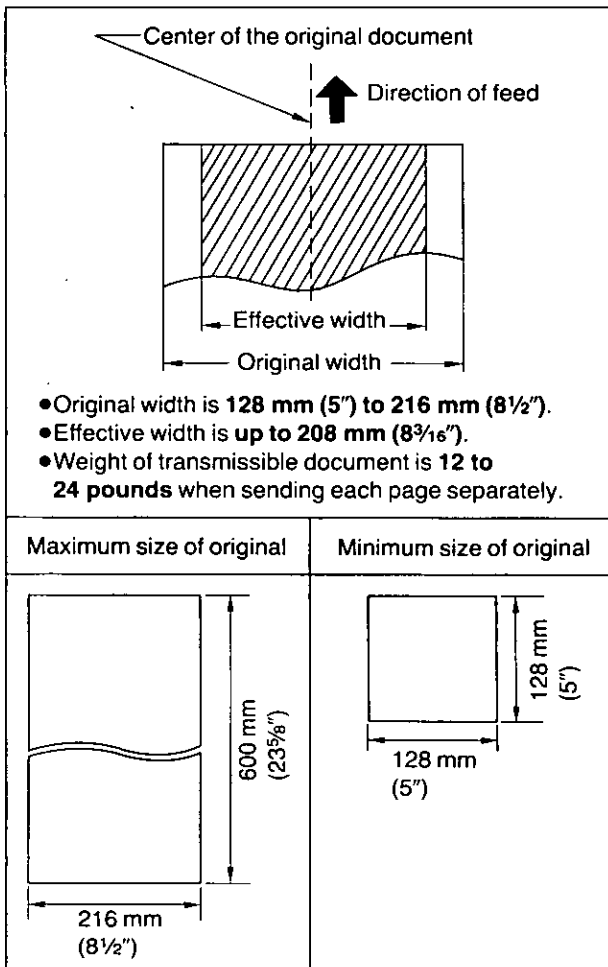

Automatic Document Feeder:

- Up to 5 pages at the same time
- Bond paper (16 to 20 pounds)
- Letter size
- Paper with an uncoated surface
- When you are transmitting a narrow document, slide the right document guide over to support the document.

NOTES:

- A document which is over 600 mm (23 5/8") cannot be transmitted. This will be indicated by the lighting of the ALARM indicator and the sounding of the alarm for 1 second.
- If the originals are electrostatically charged, the automatic document feeder may not function properly.
- In case of malfunction of the automatic document feeder, try to send each page separately.

Information on Originals

The following documents should first be copied on a copier machine, and the copy used as the fax document. Or use the exclusive carrier sheet included with your unit.

- Paper with chemically treated surfaces such as carbon-blackened paper or carbonless duplicating paper
- Heavily curled, creased or torn paper
- Paper with a coated surface
- Small size paper such as a slip or voucher
- Thin paper (less than 12 pounds)
- Wet paper with ink or paste
- Document which has staples or clips
- Make the copy using a copier machine to transmit a legible document in the following cases:
 - Thick paper (over 24 pounds), since a carrier sheet cannot be used.
 - When the contrast between the printed letter and the background is small.
 - When the letters printed on the back side can be seen from the front of the paper. (e.g. newspaper)

How to Use the Carrier Sheet

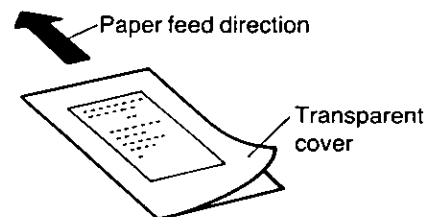

1. Place the original into the carrier sheet with the print facing the transparent cover.
2. Place the transparent cover over the original.
3. Place the carrier sheet face down against the DOCUMENT guide and insert it onto the DOCUMENT holder until it stops.

Automatic Document Reception

In most cases you will be using your unit in the in Auto Receiving mode, so that you can receive documents or messages without the need for manual operations.

To receive a document automatically, you should first record an **Outgoing Message (OGM)** and set the unit to the **Automatic Answer mode**. (The **AUTO ANSWER** indicator will light.)

FACSIMILE

Preparation

■ OGM Recording:

The purpose of the OGM (Outgoing Message) is to answer a caller during your absence.

- 1 Push **OGM** and **REC** simultaneously until a beep is heard.

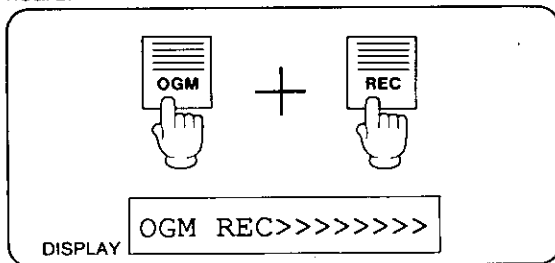

- The IN USE indicator will light.

- 2 Speak clearly and loudly.

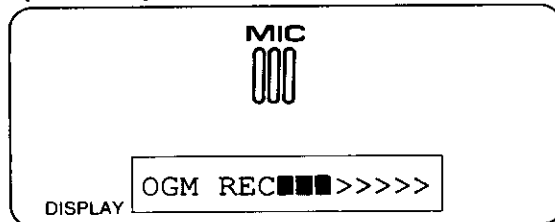

- Recording time is 16 seconds.
- Each "■" on the display represents about 2 seconds.
- Speak about 8 inches away from the MIC.
- For optimum performance, record your OGM within 12 seconds.

- 3 When you are finished, push **OGM**.

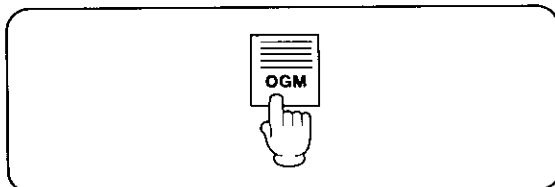

- If you want to change your OGM, simply repeat the above procedure.

■ Confirming the OGM:

Push the OGM button.

- The LCD display will show:

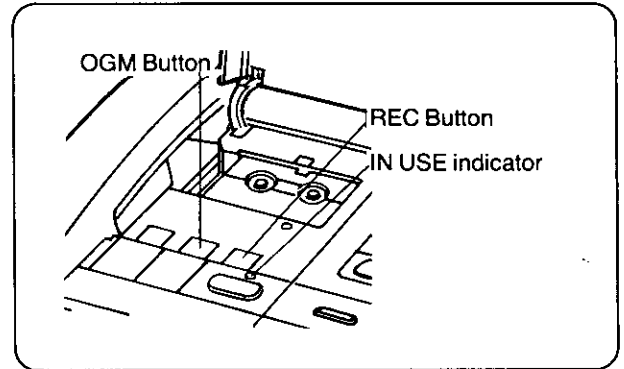
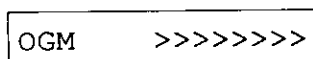

■ Recordable OGM Chip:

- Your Outgoing Message will be recorded on a voice-recordable microchip.
- Prepare and practice your announcement before you record it. Your Outgoing Message is limited to 16 seconds.

Samples of OGM

■ Set the Recording Time to "VOX".

"This is the Panasonic Company. To send a FAX, push the asterisk (*) button. To leave a message, speak after the beep".

■ Set the Recording Time to "1 minute".

"This is the Panasonic Company. To send a FAX, push the asterisk (*) button. To leave a message, speak after the beep, up to 1 minute".

NOTE:

Please record your message using the examples shown. Remember that the caller will have to push the asterisk button to begin transmission after hearing the OGM.

Automatic Document Reception (cont.)

Setting Up for Automatic Answering

- 1 Push **AUTO ANSWER** to set up.

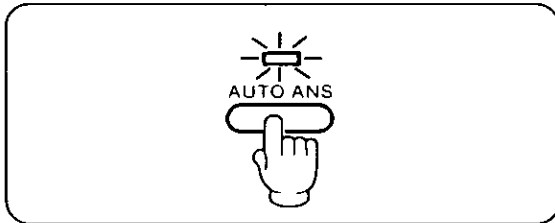

- The AUTO ANSWER indicator will light.
- The unit will automatically answer all calls.

- 2 Set the **AUTO/FAX selector** to "AUTO".

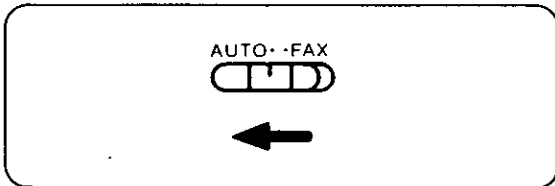

■ AUTO/FAX Selector:

•AUTO position

The unit will automatically switch between the Answering Machine and Facsimile as follows:
If the caller's voice is not heard within 5 seconds of the end of the OGM or the caller pushes the asterisk (*) button, it will automatically switch to the FAX mode to receive a document.

If a voice is detected, it will function as an Answering Machine.

•FAX position

When a call is received, the unit will function as a Facsimile (FAX) machine only.

Receiving a Document

When a call is received, the unit will answer and begin playing your recorded OGM.

If the caller's voice is not heard, leave the unit alone. The unit will automatically receive the transmitted document.

- Display will show the number of pages (99 max.) received.

RECEIVING P1

⋮

RECEIVING P4

- Tear off the recorded document as shown.

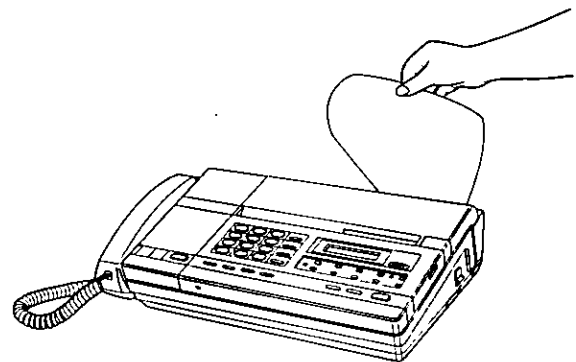

■ If you want to receive documents only:

- 1 Set the **AUTO/FAX selector** to "FAX".

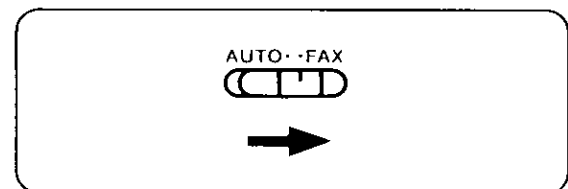

FACSIMILE

NOTE:

If someone is unable to transmit a document to you after several tries, we recommend the following.

- (i) Shorten your OGM (e.g. "To send a FAX, push the asterisk button."), and ask them to try again.
- (ii) Set the AUTO/FAX selector to "FAX" position if transmission cannot be done by using step shown in (i) above.

How to Transmit a Document Conveniently

For convenient transmission, you are allowed to store the FAX number into ten Direct Call buttons (ten FAX memory locations) for One-Touch Dialing and station number for Speed Dialing.

For more details on how to store the FAX number, refer to "Speed Dialing and One-Touch Dialing" on page 3-3.

When Using One-Touch Transmission

It is not necessary to use the handset or SP-PHONE.
The unit will automatically dial the number in the FAX memory location and transmit the document.

Be sure that the FAX number is stored in FAX memory location.

- 1 Place the document **face down**.

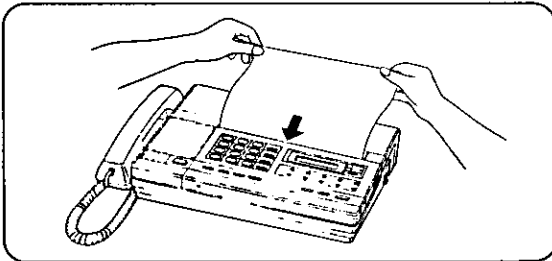

- The FAX memory locations will be automatically selected.

- 2 Push the **DIRECT CALL** button which contains the FAX number you wish to transmit to.
(e.g. If the Direct station No. is 4.)

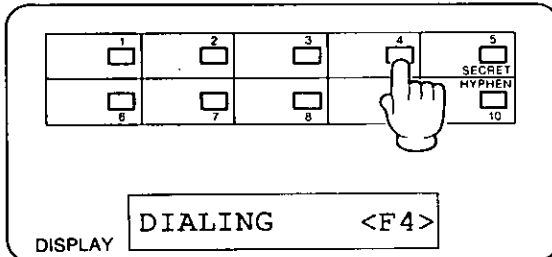

- "F" indicates FAX memory location and "4" the station No.
- Facsimile transmission will begin automatically.

■ Automatic Redialing:

When the line is busy, the unit will automatically redial the number up to 6 times within a 10-minute period.

- During a redialing, the following message is displayed.

REDIAL MODE

- To cancel, push the STOP/CLEAR button.

NOTE:

- When you push the Direct Call button;
If the document has been placed onto the DOCUMENT holder, the unit will dial using the FAX memory location and transmit the document.

If the DOCUMENT holder is empty, the unit will dial using the telephone memory location.

How to Transmit a Document Conveniently (cont.)

When Using Speed Dialing

- 1 Place the document **face down**.

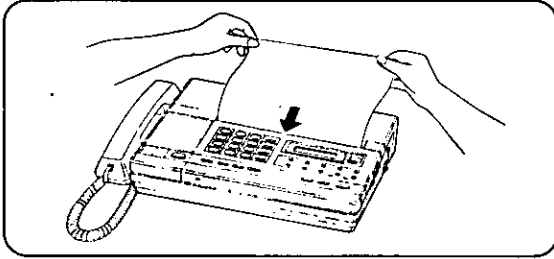

- 2 Lift the **handset** or push **SP-PHONE**.

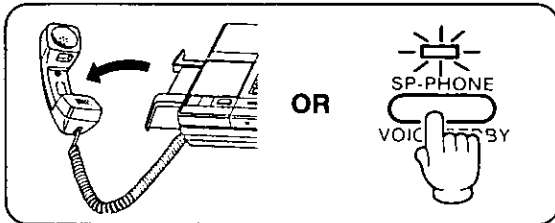

- 3 Enter the **speed dial No.**
00 to 99 (2 digits)
(e.g. If the station No. is 12)

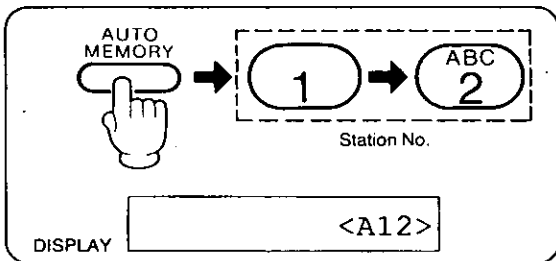

- "A" indicates Auto and "12" the station No.

- 4 When the answering carrier tone is heard, push **START/COPY**.

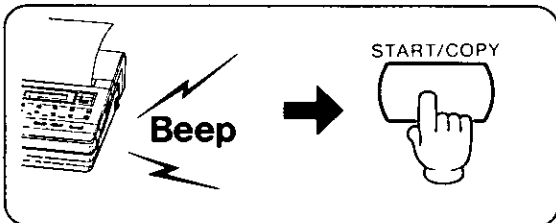

- 5 After pushing **START/COPY**, replace the handset.

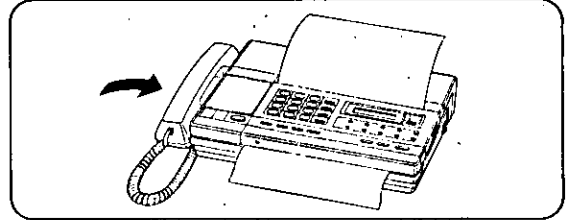

- Facsimile transmission will begin automatically.

FACSIMILE

Voice Contact

While you are transmitting or receiving documents, you may wish to speak with the other party. If the other party's unit is equipped with the voice contact feature, you can initiate voice contact as follows.

Initiating Voice Contact During Transmission or Reception

- 1 Lift the handset or push **SP-PHONE**.

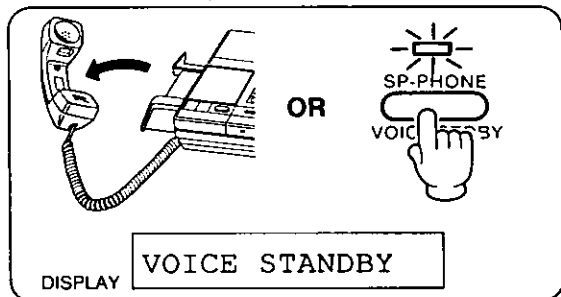

- 2 When the other party answers, start speaking.



■ During Transmission:

If you initiate voice contact during transmission, you will be able to speak **after all of the documents have been transmitted**.

The other party's unit will ring or beep depending on the type of unit, **after all of the documents have been sent**.

■ During Reception:

If you initiate voice contact during receipt of a document, you will be able to speak **after receiving the current page of the document**.

The other party's unit will ring or beep depending on the type of the unit **after current page has been sent**.

Receiving a Request for Contact

If the other party tries to contact you during transmission or reception of a document, the following message will appear on the LCD Display, and the unit will beep.

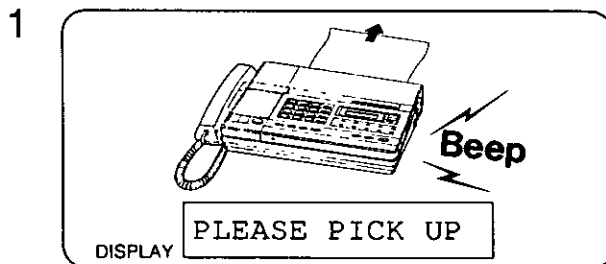

- 2 Lift the handset or push **SP-PHONE**.

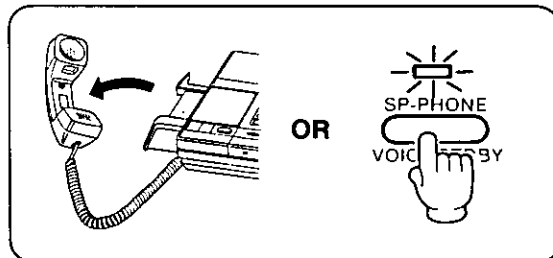

- 3 Start speaking.



NOTES:

- When you are using the handset and wish to speak with the other party immediately after the transmission is completed, do not replace the handset after pushing the START/COPY button. This will cause your unit to automatically call the other party.
- If you receive a Request for Voice Contact and you do not pick up the handset or push the SP-PHONE button, the unit will automatically switch to the Incoming Message recording mode, 10 seconds after the beeps are heard, if the AUTO/FAX selector is set to "AUTO", and the AUTO ANSWER indicator is lit.
- It may happen that the voice contact cannot be done because of the type of the voice contact provided with the other party's unit.

How to Operate Your Unit from a Remote Location

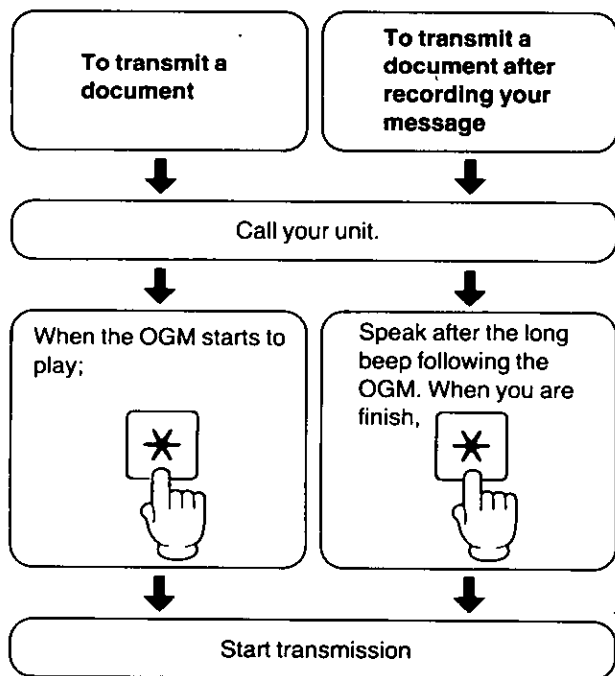

- When you use a rotary (pulse) phone, see included leaflet "FAX CORRESPONDENCE".
- **To record a voice message after transmitting a document to another KX-F3500:**
 - 1 During transmission, lift the handset or push the SP-PHONE button.
 - 2 Speak after the long beep following the OGM.

Other Informations

- If a caller hangs up during or immediately after hearing the OGM, the START/COPY indicator may flash for about 40 seconds, but nothing is recorded. This may occur due to differences in Central Office lines and is a normal condition.
 - If you are using a call waiting service, and a call is received at the same time that a document is being received, the document may include distorted characters, or reception errors may occur.
 - If a telephone connected in parallel with your unit is used during transmission of a document, the document may be sent with distorted characters.
 - If the letters and/or drawing in an original document are small or intricate, change the Scanning Line Density (Resolution) to "FINE". When you transmit the FAX CORRESPONDENCE sheet, we recommend that you set to "FINE" so that the other party can receive a clear copy.
 - If the condition of the telephone line is poor (noisy) or the recording paper of the receiving unit is out, the ALARM indicator will flash and a beep will be heard. During these conditions, transmission is not possible.
 - When you are transmitting a narrow document, slide the right document guide over to support the document.
- **WARNINGS:**
- When the unit is used in the facsimile mode for a long time, it may overheat and stop operating. The LCD display will show "WAIT, OVER HEATED". At this time, do not disconnect the AC cord from the power outlet. Operation will automatically resume as soon as the unit has cooled.
 - If you should experience difficulty transmitting/receiving a document (particularly international FAXES) because of poor telephone line conditions, refer to the INSTALLATION MANUAL.

FACSIMILE

Delayed Transmission

By programming the unit with a starting time and a FAX number, you can automatically transmit a document anywhere in the world, and at any time of the day. This operation can be reserved to take place up to 24 hours after setting the timer.

Setting Up Delayed Transmission (On/Off, Starting Time and Fax Number)

- 1 Place the document **face down** onto the holder.

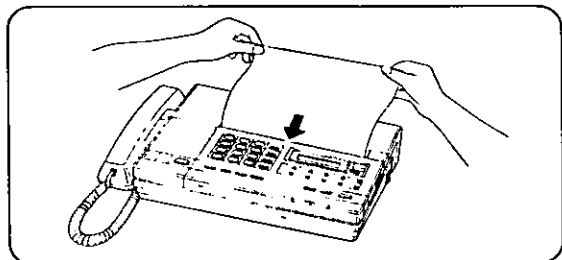

- 2 Push **FUNCTION**.

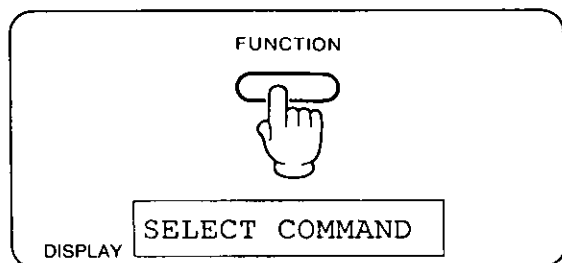

Setting Delayed Transmission

- 3 Push **REDIAL** or **MUTE** until the following message is displayed.

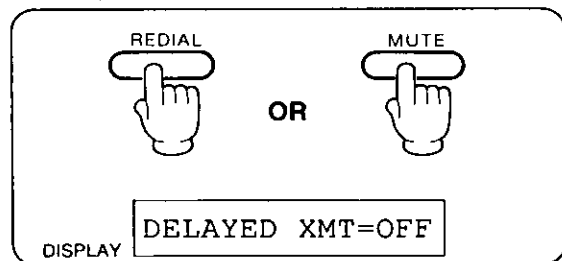

- During the programming mode the "REDIAL" and "MUTE" buttons are used to step through the various programming functions.

- 4 Push **MODE** to turn on DELAYED TRANSMISSION (XMT).

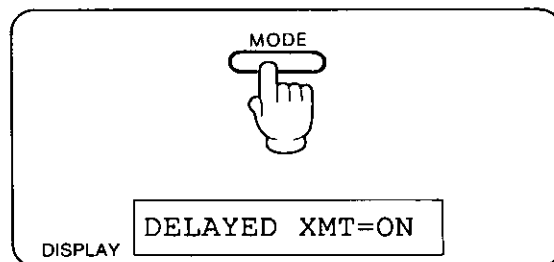

- "ON" and "OFF" are changed alternately each time you push the MODE button.

- 5 Push **AUTO/MEMORY**.

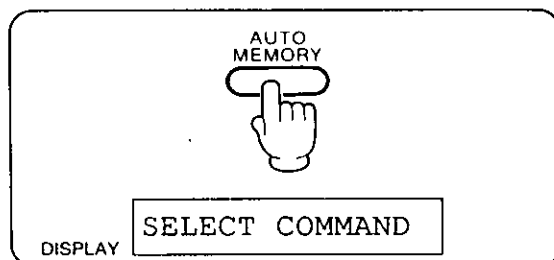

- Delayed XMT is now stored in memory.

Setting the Sending Time

- 6 Push **REDIAL** to step to the programming mode for the Starting time.

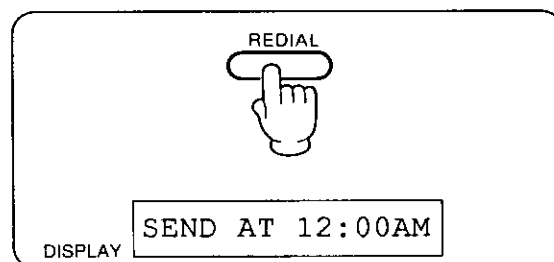

Delayed Transmission (cont.)

- 7** Enter the time (e.g. 8:30 PM) at which the fax is to be sent.

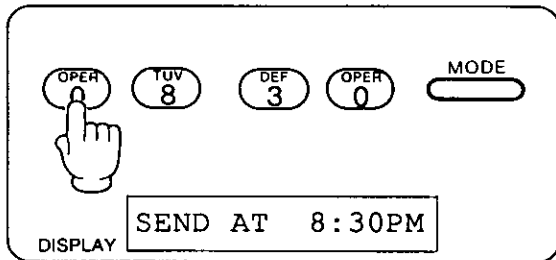

- Push MODE to select AM/PM mode.
- Push "*" and "#" to move the cursor left and right respectively.

- 8** Push **AUTO/MEMORY**.

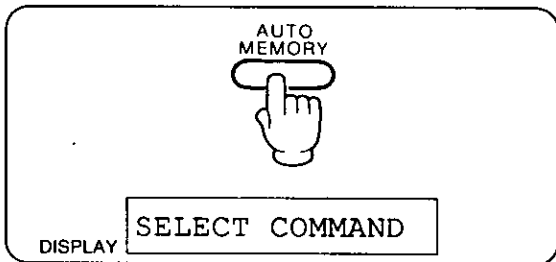

- The starting time is now stored into memory.

- 9** Push **REDIAL** to program the Fax number.

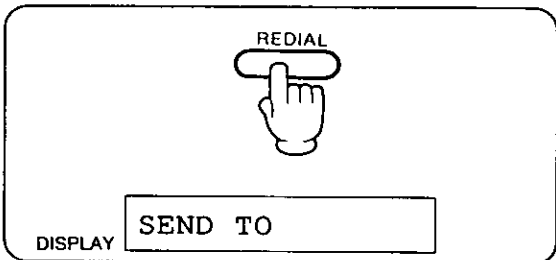

Setting FAX Number

- 10** Enter the FAX number you wish to transmit to.

- **To Use One-Touch Dialing:**
Push the **DIRECT CALL** button.
(e.g. If the Direct station No. is 4.)

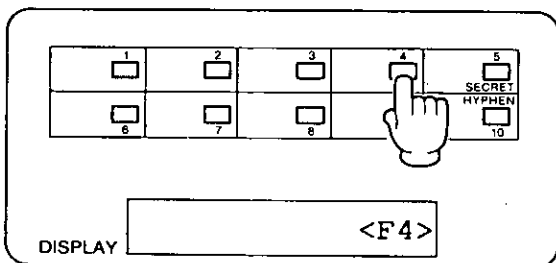

- **To Use Speed Dialing:**

Push **AUTO/MEMORY** then **Station No.**
(e.g. If the station No. is 12)

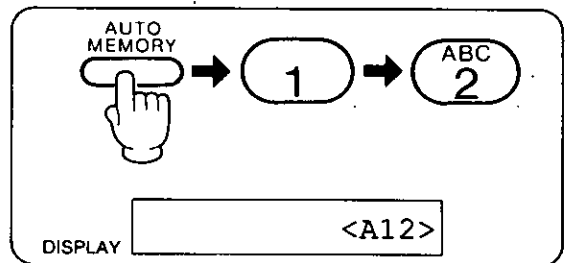

- **To Use Manual Dialing:**

Dial the number then push **AUTO/MEMORY**.
(e.g. If the FAX No. is 1234567)

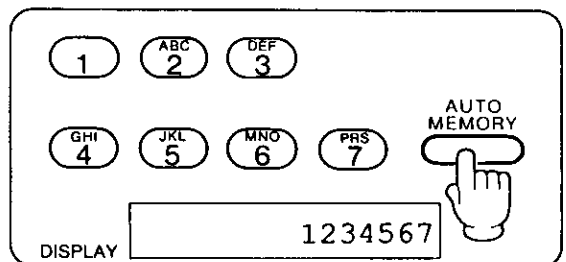

NOTE:

When dialing manually, you must push the **AUTO/MEMORY** button after entering the number. This is not necessary when using One-Touch or Speed Dialing.

- 11** Push **FUNCTION** to end the operation.

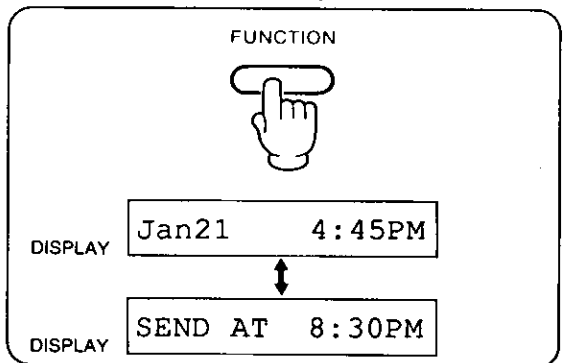

- Display will show current time and transmission time alternately and the document will be transmitted at the time selected.

Delayed Transmission (cont.)

■ To Change the Parameter after set up:

Push the FUNCTION button then the REDIAL button until the display shows the parameter to be changed. Change the parameter using the above procedure.

■ To Cancel the Delayed Transmission:

Change the "DELAYED XMT=ON" to "DELAYED XMT=OFF".

NOTES:

- Automatic and manual reception, transmission and copying function can be performed when Delayed transmission is set.
- To transmit or copy a document, remove the document relating to the Delayed transmission and replace it when you are done.
- If the line is busy when performing the delayed transmission, the unit will automatically redial the number, up to 6 times within a 10-minute period.

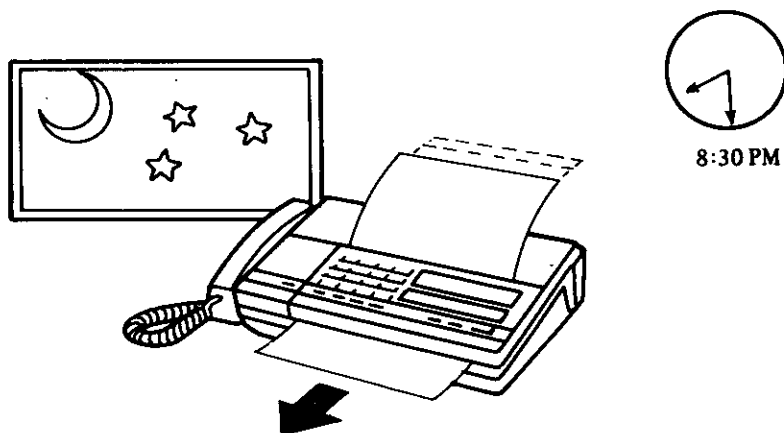

Making a Copy

The unit may also be used to make single or multiple copies. Any documents which can be transmitted can also be copied.

- 1 Place the document **face down** onto the holder.

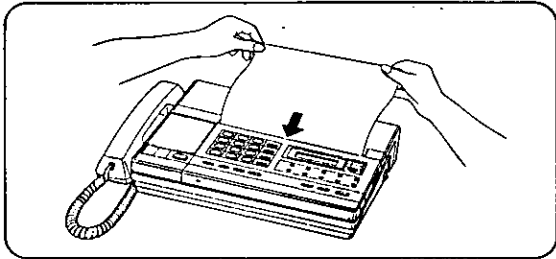

- 2 Push **START/COPY**.

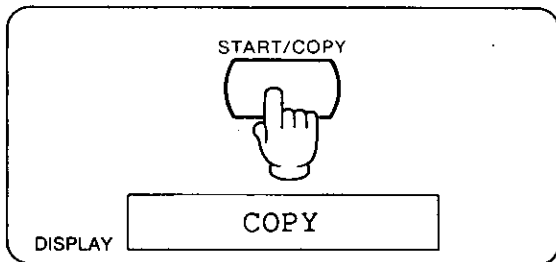

■ **To abort a copy:**

Push **STOP/CLEAR** firmly.

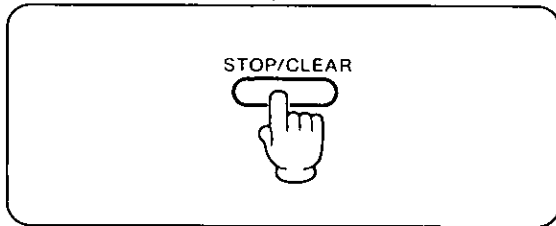

- The document will be ejected.
- If the document does not feed straight while making a copy, stop copying, open the cover and pull out the document.

■ **If the LCD Display shows "OUT OF PAPER";**
Replace the paper. Refer to "Recording Paper Installation" on page 4-1.

■ **To copy continuously:**

Insert additional pages when the last page disappears from the top of the DOCUMENT holder and while the START/COPY indicator is still lit.

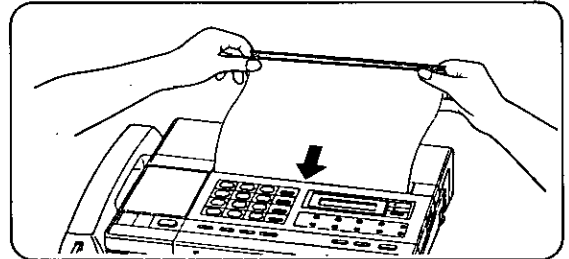

NOTE:

- The document feeder can handle up to five sheets at a time. The top sheet of the document will be copied first.
- Weight and/or size of usable document are the same as transmissible document.
(Refer to "Transmissible Document" on page 1-4)

Individual Transmission Report

Each time a document is transmitted, this function will cause a record of the transmission to be printed.
Once Individual Transmission Report is set ON, it will remain ON until it is switched OFF.

FACSIMILE

1 Push **FUNCTION**.

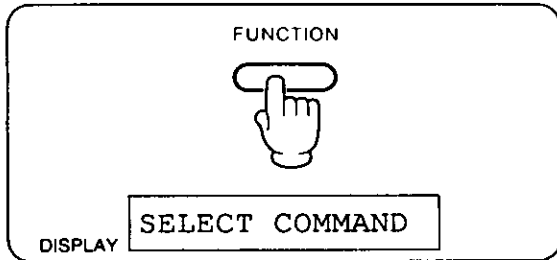

4 Push **AUTO/MEMORY** to store your selection.

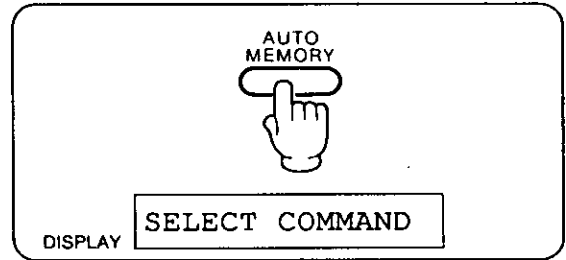

2 Push **MUTE** or **REDIAL** until the following message is displayed.

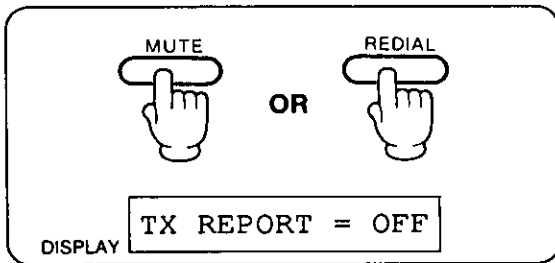

5 Push **FUNCTION** to end the operation.

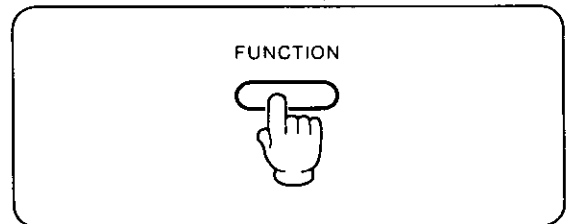

3 Push **MODE** to turn on TX (Transmit) Report.

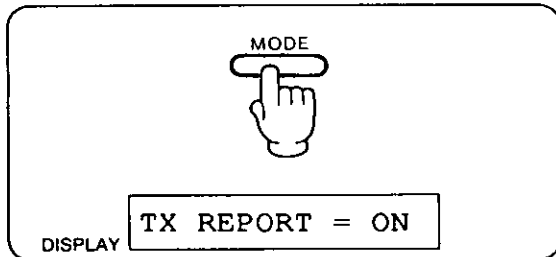

- "ON" and "OFF" are changed alternately each time you push the MODE button.

[INDIVIDUAL TRANSMISSION REPORT Example]

No.	OTHER FACSIMILE	< TX REPORT >		USAGE TIME	PAGES	RESULT
		MODE	START TIME			
01	1732526	TX(G3)	Jan. 01 12:00AM	00'42	01	OK

Activity Report (JOURNAL)

The **JOURNAL** is a record of the last 30 transactions (transmission and receptions). It is printed out automatically after every 30 transactions when the JOURNAL is set to the AUTO mode. It may also be printed out on request.

- 1 Push **FUNCTION**.

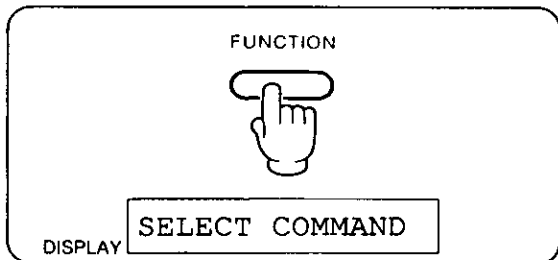

- 2 Push **MUTE** or **REDIAL** until the following message is displayed.

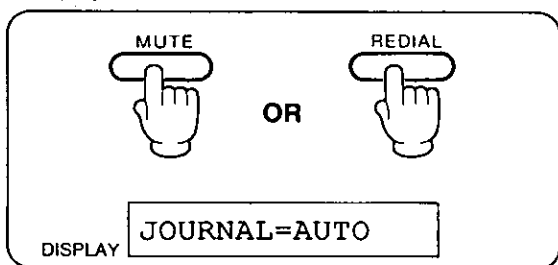

- 3 Push **MODE** to change to MANUAL mode.

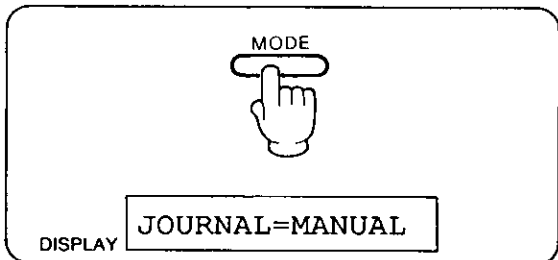

- "AUTO" and "MANUAL" are changed alternately each time you push the MODE button.

- 4 Push **AUTO/MEMORY** to store your selection.

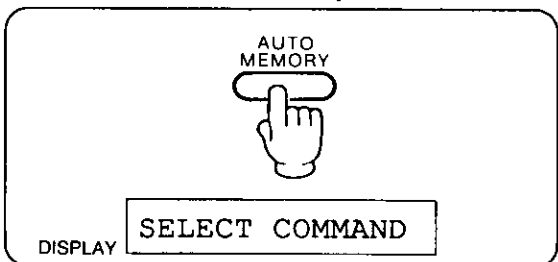

- 5 Push **FUNCTION** to end the operation.

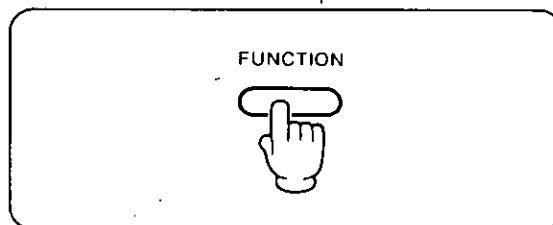

- You can find the JOURNAL Example on page 1-18.

■ **When set to the AUTO mode:**

The Activity Report will be automatically printed when the memory becomes full (30 transactions). The journal memory will then be cleared.

■ **When set to the MANUAL mode:**

The Activity Report will be stored until the memory becomes full. The oldest line of the report will then be deleted.

When printing out the report using the MANUAL mode, refer to "Printout Functions" on page 1-17.

Printout Function

A list of Transmissions/Receptions (**JOURNAL**), Stored Phone Numbers (**TEL LIST**) and/or User Selections (**SYSTEM**) can be printed out on request.

1 Push **FUNCTION**.

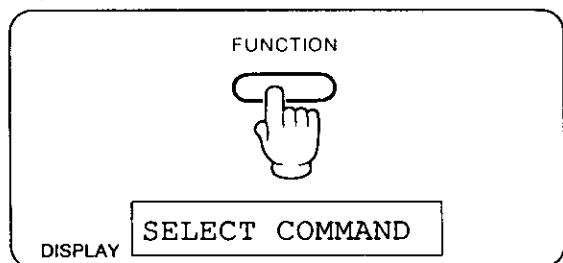

2 Push **MUTE** or **REDIAL** until the following message is displayed.

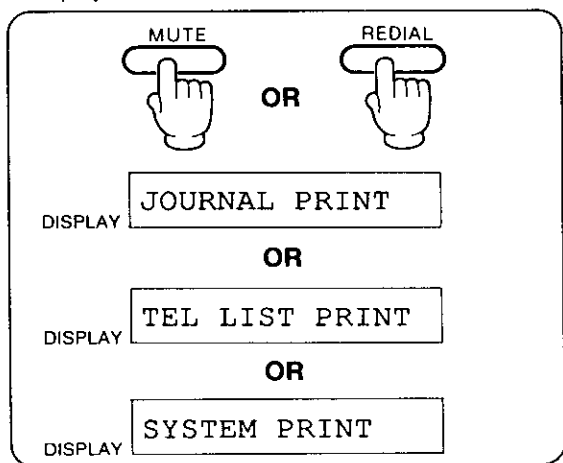

3 Push **START/COPY** to start printing.

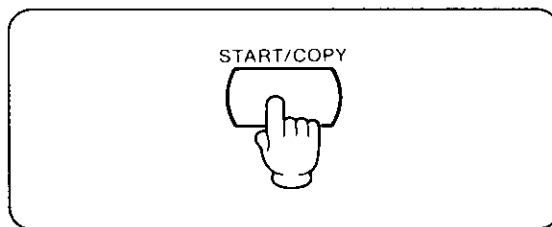

4 Push **FUNCTION** to end the operation.

■ **List of Transmissions/Receptions (JOURNAL)**

This is a report of the last 30 transmissions and receptions. If there was no activity, no JOURNAL will be printed.

■ **Stored Phone Numbers (TEL LIST)**

This is a list of stored phone number for One-Touch and Speed dialing.

■ **User Selections (SYSTEM)**

This is a report on all of the User selections and initial settings.

[TEL LIST Example]

<< TELEPHONE NO. LIST >>

TEL NO

01 T222-2222
02 T2345
03 T800-447-4700
04 T205-525-4195
05 T333-3333
06 T123-4567
07 T999

FAX NO

01 T123-1234
02 T3434
03 T392-4767
04 T3435
05
06 T123456789
07 T098-765-4321

Explanation of TEL LIST

- T...When you enter the telephone number with setting the Dialing Mode Selector to the TONE position.
- R...When you enter the telephone number with setting the Dialing Mode Selector to the PULSE position.

00 R526-3057

Printout Function (cont.)

FACSIMILE

[JOURNAL Example]

<<< JOURNAL >>>

(3) No.	(4) OTHER FACSIMILE	(5) MODE	(6) START TIME	(1) Jul. 20, 1988 (7) USAGE TIME	(2) 01:34 PM (8) PAGES	(9) RESULT
01	1736852	TX(G3)	Jul. 20 11:39AM	00' 42	01	OK
02	INCOMING	RX(G3)	Jul. 20 11:41AM	01' 38	01	04
03	<A11>	TX(G3)	Jul. 20 11:46AM	00' 46	01	OK
04	<F2>	TX(G3)	Jul. 20 11:48AM	00' 40	01	OK
05	INCOMING	TX(G3)	Jul. 20 11:49AM	00' 45	01	OK
06	INCOMING	TX(G3)	Jul. 20 11:57AM	00' 29	01	OK
07	<F2>	TX(G3)	Jul. 20 11:59AM	00' 20	01	02
08	<F2>	TX(G3)	Jul. 20 12:00PM	00' 09	00	02
09	INCOMING	RX(G3)	Jul. 20 12:03PM	00' 33	00	06
10	<A11>	TX(G3)	Jul. 20 12:05PM	00' 16	00	07

Explanation of JOURNAL

- (1) Date of printout: Month, Day, Year
- (2) Time of Printout: Hour: Minute
- (3) Communication number (up to 30)
- (4) Dial Number
1736852: The other party's number dialed manually is 1736852
A11: Station No. 11 for Speed Dialing is used.
F2: Station No. 2 for One-Touch Dialing is used.
INCOMING: Document or telephone call is received.

- (5) Transmission/Reception
TX: Transmission
RX: Reception
G3: Communication mode used
- (6) Communication start time
- (7) Usage time: Minutes: Seconds
- (8) Number of pages transmitted or received successfully
- (9) Communication result
OK: Successful completion
Numeral: Error code (See Error code below.)

CODE	DESCRIPTION	CODE	DESCRIPTION
01	When the power unit overheats.	04	When transmission/reception error occurs.
02	When transmission is interrupted by pushing the STOP/CLEAR button.	05	When the printhead overheats.
		06	When the unit is out of paper.
03	When a document is jammed or does not feed into the unit.	07	When the cover is opened.

[SYSTEM Example]

```
<< SYSTEM SET UP LIST >>
#01 1/ 1/88 12:00AM
#02 SENDER ID =
#03 DELAYED XMT=OFF
#04 SEND AT 12:00AM
#05 SEND TO
#06 REMOTE ID = 111
#07 REC TIME = VDX
#08 CPC MODE = A
#09 DIAL SPEED = 10
#10 TONE DETECT=ON
#11 JOURNAL=AUTO
#12 TX REPORT = OFF
#13 TX SPEED = 9600
#14 ID POSITION=OUT
```

How to Operate as an Answering Machine

Table of Contents

Preparing the Answering Machine	2-1
Recording OGM	2-1
Selecting the Caller's Recording Time	2-1
Selecting the Remote Code No. for Remote Operation	2-2
Setting Up the Automatic Answer Mode	2-3
Preparing the ICM Tape	2-3
Operating the Answering Machine	2-4
Playing Back Your Messages	2-4
Call Counter	2-4
Saving Your Messages	2-4
Erasing the ICM	2-5
Monitoring Incoming Calls	2-5
Message Memo	2-6
Recording a 2 Way Conversation	2-6
How to Operate from a Remote Phone	2-7
Turning On the Automatic Answer Mode from a Remote Phone	2-7
Playing Back Messages	2-7
Memory Playback	2-8
Back Space and Skip Forward	2-8
Recording a Marker Message	2-8
Remote Reset	2-9
Skipping OGM for ICM Recording	2-9
Turning On the Speakerphone (Answer Back)	2-10
Changing the OGM	2-11

Preparing the Answering Machine

To use the unit as an Answering Machine, you should first record an Outgoing Message (OGM).

- The purpose of the OGM is to answer the caller during your absence.
- To have calls answered automatically during your absence, set the unit to the Automatic Answer (AUTO ANS) mode.
- To record voice messages, select the recording time.

Recording OGM

See "Preparation-OGM Recording" on page 1-5.

Selecting the Caller's Recording Time

The Recording Time for Incoming Messages can be set to "VOX" or "1 minute".

Be sure that the handset is on the cradle and that the SP-PHONE button is off.

The Recording time is preset to "VOX".

- 1 Push **FUNCTION**.

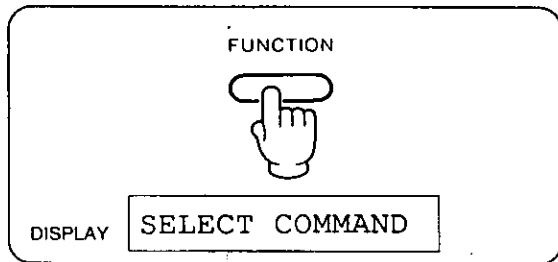

- 2 Push **REDIAL** or **MUTE** until the following message is displayed.

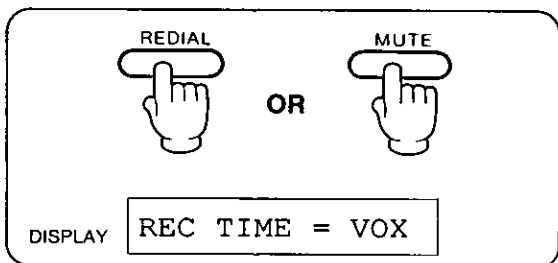

- 3 Push **MODE** if you wish to change.

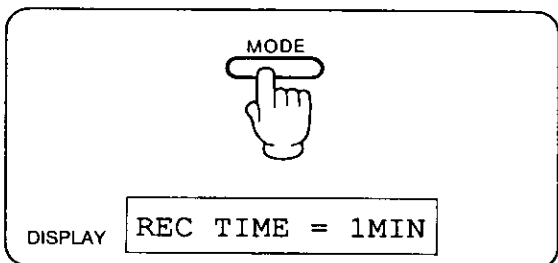

- "VOX" and "1 MIN" are changed alternately each time you push the MODE button.

- 4 Push **AUTO/MEMORY**.

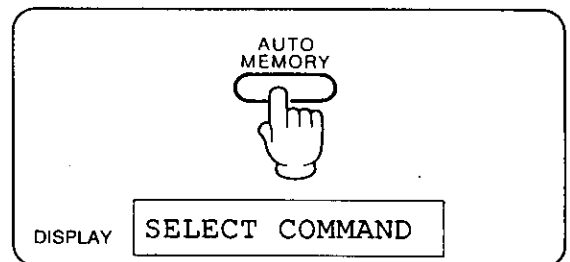

- After pushing the AUTO/MEMORY button, you may go directly to step 2, "Selecting the Remote Code No. for Remote Operation" if you wish.

- 5 Push **FUNCTION** to end the operation.

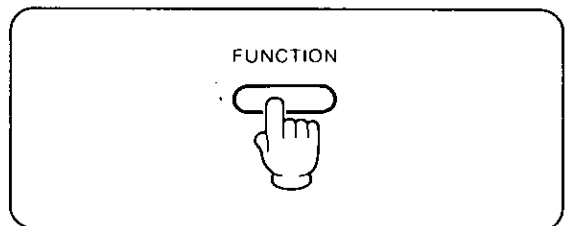

- **VOX:**
The unit will record an Incoming Message for as long as the caller speaks.
- **1 Minute:**
The unit will record an Incoming Message (ICM) up to 1 minute.

Preparing the Answering Machine (cont.)

Selecting the Remote Code No. for Remote Operation

A remote code helps to protect from unauthorized persons accessing your unit and retrieving your messages. The remote code No. has been set to 111 at the factory. However, you may choose another code from within the following ranges:

Single Digit 1 to 9
Double Digit 11 to 99
Triple Digit 111 to 999

1 Push **FUNCTION**.

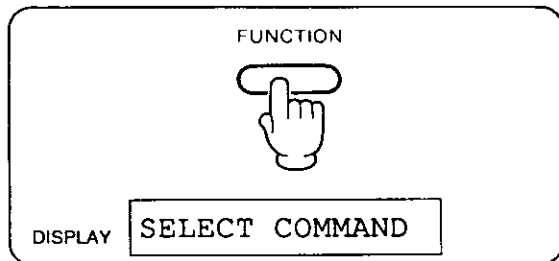

2 Push **REDIAL** or **MUTE** until the following message is displayed.

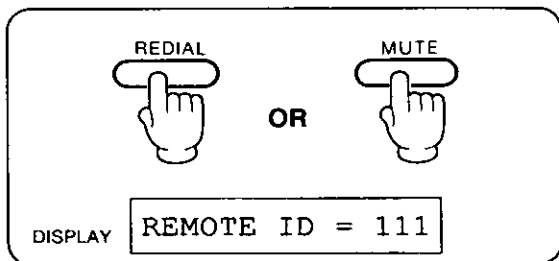

3 Enter the desired **Remote Code** and then push **AUTO/MEMORY**.
(e.g. If the remote code is 123)

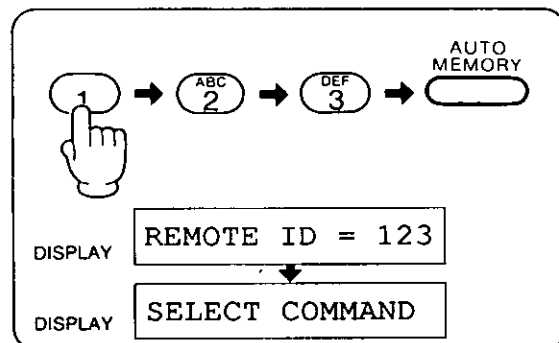

4 Push **FUNCTION** to end the operation.

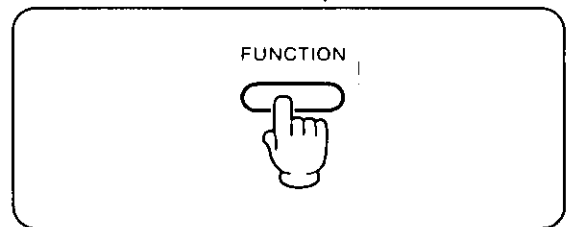

NOTE:

You cannot use codes which include zero (0). We recommend that you do not use seven (7) as code No., since this number is used to control other remote function.



Preparing the Answering Machine (cont.)

Setting Up the Automatic Answer Mode

- 1 Push **AUTO/ANS**.

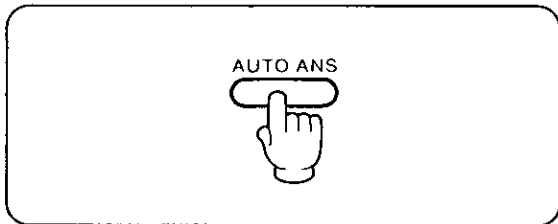

- The AUTO/ANS indicator will light.

- 2 Set **AUTO/FAX selector** to **AUTO**.

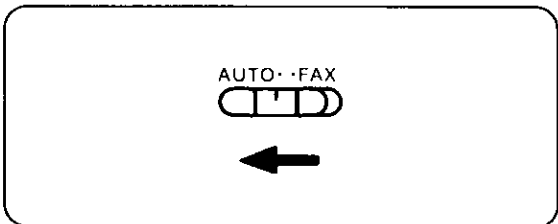

- Before leaving the office, confirm that the AUTO/ANS indicator is lit and the AUTO/FAX selector is set to AUTO or FAX (as needed).

AUTO/FAX Selector

■ AUTO Position

When a call is received, the unit will answer and begin playing your OGM. If the caller's voice is not heard within 5 seconds of the end of the OGM or the caller pushes the asterisk (*) button, the FAX mode will automatically be selected.

If a voice is detected, the unit will function as an Answering Machine.

■ FAX Position

When a call is received, the unit will function as a Facsimile (FAX) Machine only. No OGM will be played and no messages can be left on the answering machine. Remote operation (from another phone) is also impossible.

- To cancel the Automatic Answer mode, push the AUTO/ANS button. The AUTO/ANS indicator will go out. The unit will now function as a telephone.

Preparing the ICM Tape

After reviewing the Outgoing or Incoming Messages, the unit will automatically reset itself to the Automatic Answer mode and will be ready to answer the next call.

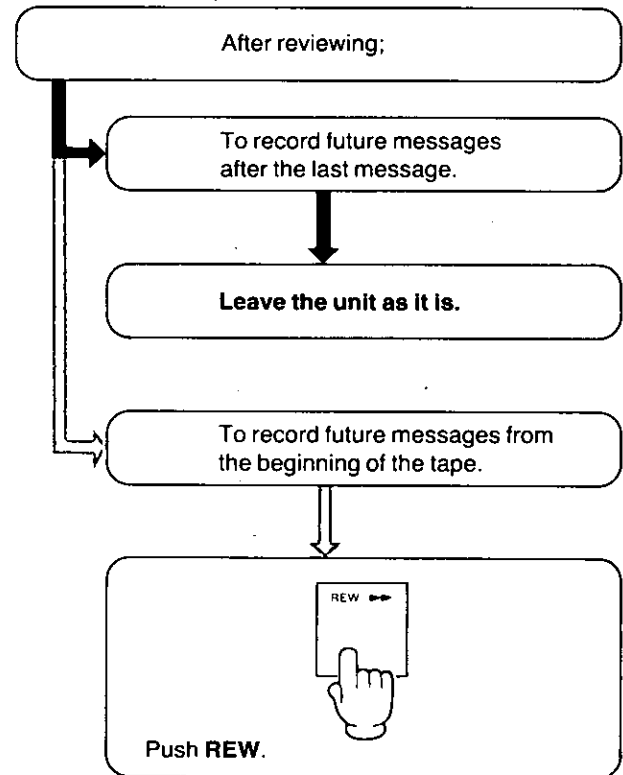

- If you use a new ICM tape, push the REW button to reset the tape.

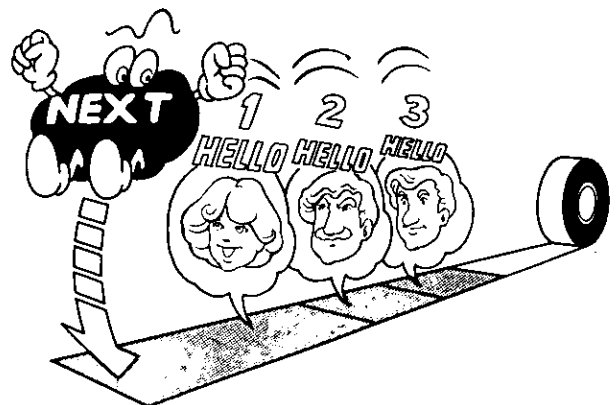

Operating the Answering Machine

Playing Back Your Messages

- 1 Push **PLAYBACK/PAUSE**.

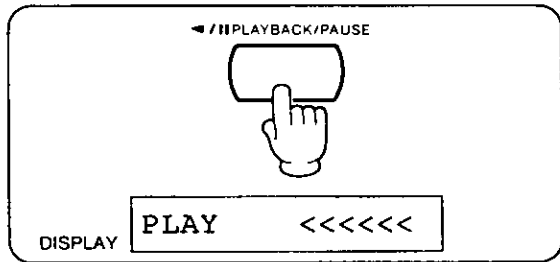

■ Auto-Logic (One Touch Operation)

At the touch of the **PLAYBACK/PAUSE** button, the unit will automatically rewind, playback all the recorded messages and stop. After 7 seconds, the unit will reset itself to the Automatic Answer mode. All calls will be automatically saved.

- **Future Incoming Messages will be recorded after the last message.**
- **To record the future messages from the beginning of the tape, push the **REW** button.**

■ To stop the tape temporarily:

- 1 Push **PLAYBACK/PAUSE**.

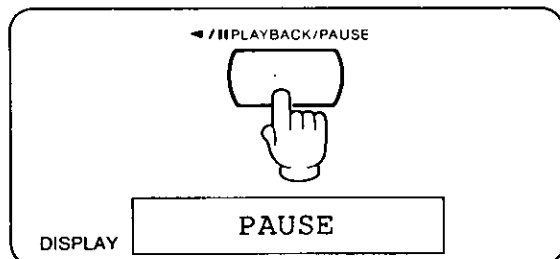

- To restart, push the **PLAYBACK/PAUSE** button again.
- While pausing, the unit does not answer a call automatically.

■ To Rewind the Tape:

Push the **REW** button.

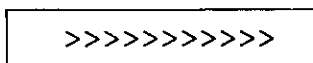

■ To Fast Forward the Tape:

Push the **FF** button.

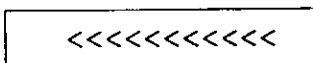

Call Counter

The unit will show you the number of recorded voice messages by indicating it on the LCD Display (0~99) and flashing of the **AUTO/ANS** indicator.

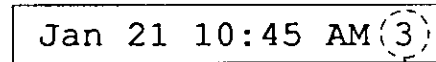

The number of recorded voice messages

Saving Your Messages

You can save your messages as follows:

- 1 Play back the tape to the end of the message you want to save then push **REW** and **PLAYBACK/PAUSE** simultaneously.

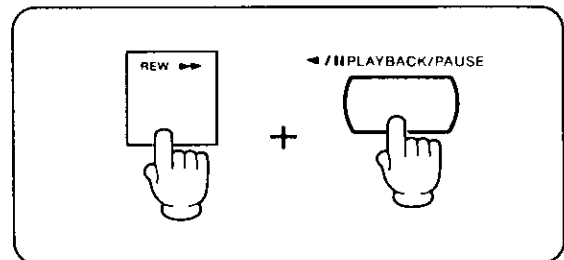

- The unit will go into the Answer mode and future Incoming Messages will be recorded after the messages you have saved.

Operating the Answering Machine (cont.)

Erasing the ICM

To Erase the Recorded Messages:

Wait until the last message has played back and the tape stops.

- 1 Push **REC** and **REW** simultaneously.

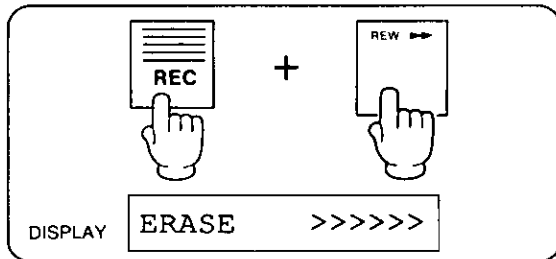

- The messages will be erased while the tape is rewinding.

NOTE:

The tape can be erased at high speed even if the record-prevention (knock-out) tabs have been removed.

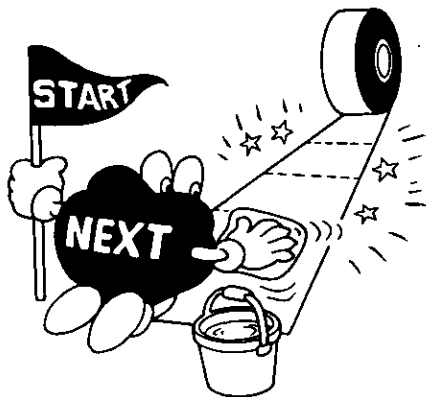
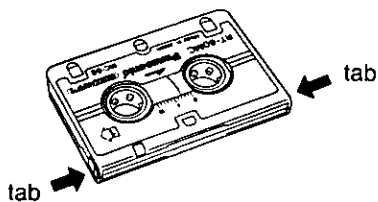

Monitoring Incoming Calls

While an Incoming Message is being recorded, you can monitor it through the built-in speaker by adjusting the **SPEAKER VOLUME** control.

- The following message will be displayed on the display.

ATAS ANSWERING

To speak to the caller directly:

- 1 Lift the **handset** or push **SP-PHONE** and speak.

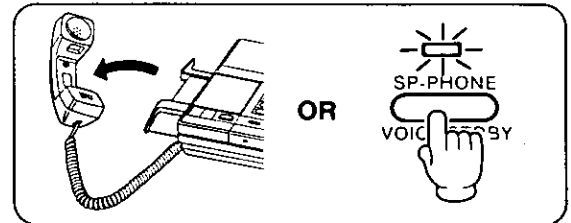

- The tape will stop.

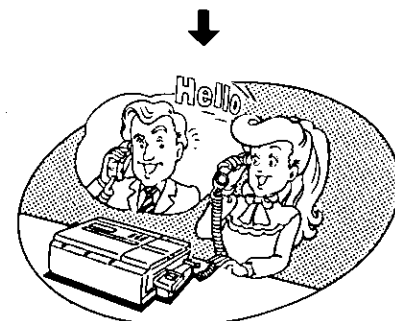
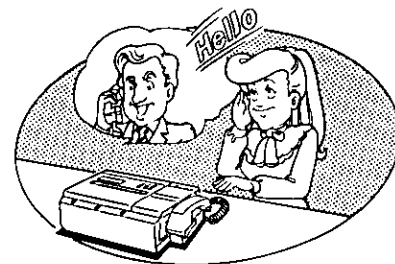

ANSWERING MACHINE

Operating the Answering Machine (cont.)

Message Memo

You can record a confidential message on the Incoming Message tape (ICM) which can be retrieved by anyone with your remote code number.

- 1 Push **2 WAY/MEMO** until a beep is heard.

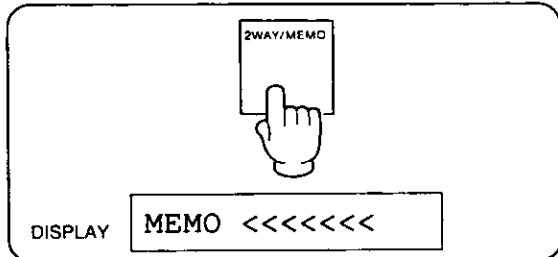

- The IN USE indicator will light.

- 2 Speak into the **Microphone** to record your message.

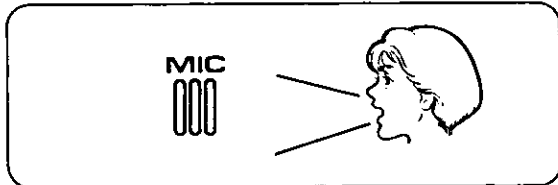

- 3 When you are finish, push **2 WAY/MEMO** again.

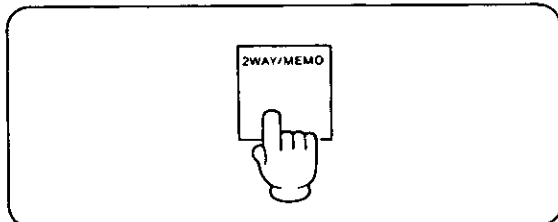

- The IN USE indicator will go out.
- The unit will return to the Auto Answer mode if the AUTO ANS indicator is on.

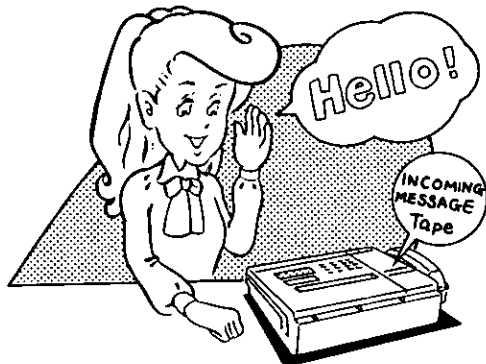

Recording a 2 Way Conversation

While speaking with someone on the telephone, you can record the conversation, **however, many states have regulations in which 2-Way Telephone Conversations may be recorded**, so you should first consult your public utility agency before using this feature.

■ To record a 2-Way Conversation:

- 1 While speaking, push **2 WAY/MEMO** until a beep is heard.

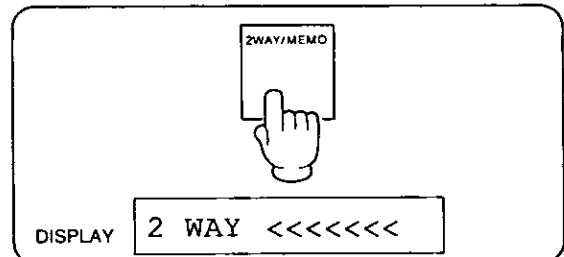

- The IN USE indicator will light.

- 2 Talk with the other party.



- The unit will generate a beep every 15 seconds to notify the caller that the conversation is being recorded.

- 3 When you are finish, push **2 WAY/MEMO** again.

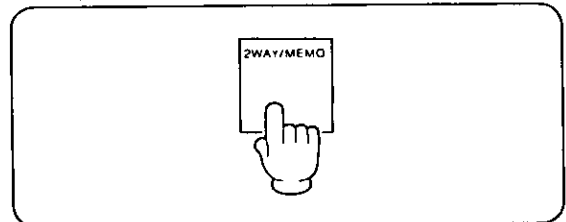

- The IN USE indicator will go out.

How to Operate from a Remote Phone

You can use a tone phone to listen your recorded Incoming Messages, from a remote phone.

Turning On the Automatic Answer Mode from a Remote Phone

If you forget to turn your unit to the Automatic Answer mode before leaving your office, you may turn it on from a remote location, using any telephone.

- 1 Call your unit and wait for 15 rings.

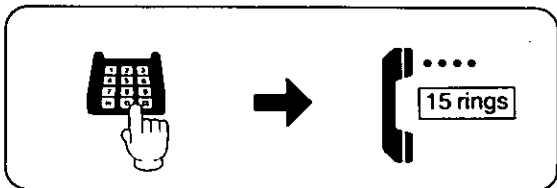

- After 15 rings, the unit will switch to the Automatic Answer mode.

- 2 After hearing the OGM or the beep tone, hang up.

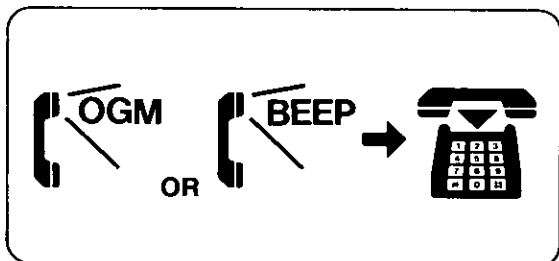

- If the AUTO/FAX selector is set to "AUTO", the unit will begin to play the OGM.
- If the AUTO/FAX selector is set to "FAX", you will hear several "beeps" (answering carrier tone of your unit).

NOTES:

- If you hear nothing, record the OGM.
- The beep will be heard after the OGM.
1 beep: You may hang up.
6 beeps: The tape is full. Reset the tape. See "Remote Reset of Tape" on page 2-9.

Playing Back Messages

- 1 Call your unit.

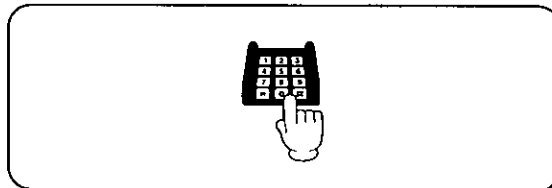

- 2 Push your code No. during the OGM.

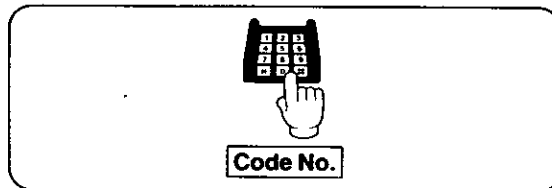

- A beep will sound, followed by other (up to 8) beeps, which represent the number of recorded messages.
- Another series of short beeps will be heard as the ICM tape is rewinding and then your message will be played.

- 3 Listen to messages.

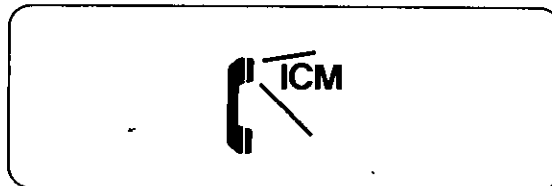

- 3 beeps will be heard after the last message.

- 4 Hang up the handset.



- Future Incoming Messages will be recorded after the last message.

How to Operate from a Remote Phone (cont.)

Memory Playback

If you have already heard your old messages from a remote phone, you can skip them and only listen to the newly recorded ones.

- 1 Call your unit.

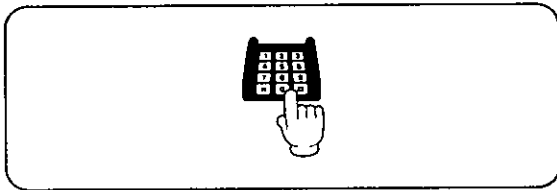

- 2 Push your **code No.** during the OGM.

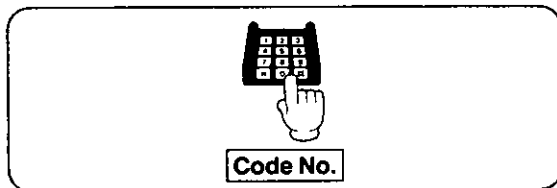

- 3 After hearing the beeps, push "4" immediately.

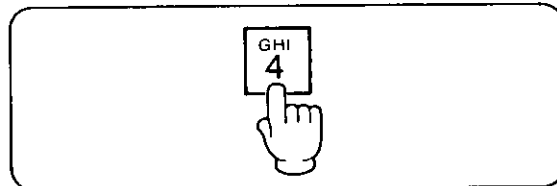

- The beeps indicate the number of recorded messages.
- During the playback of previously heard messages, you can also skip them by pushing "4".

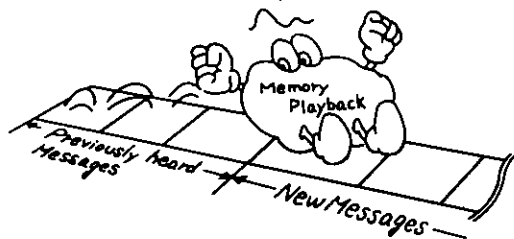

Back Space and Skip Forward

After listening to the recorded messages or while they are playing, you can skip forward or back space.

■ Back Space:

- 1 Push "1".

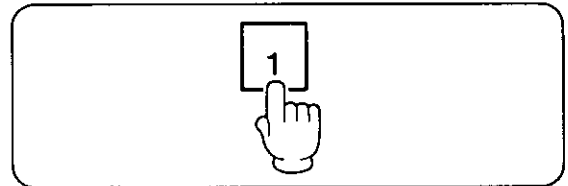

■ Skip Forward:

- 1 Push "2".

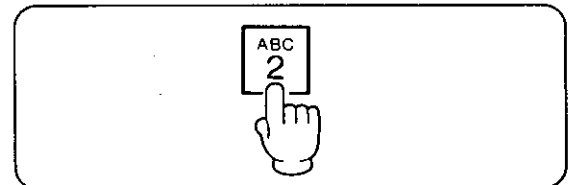

- The tape will rewind or advance for approximately 15 seconds of playback time, and not to the beginning or end of a message.

Recording a Marker Message

After reviewing all the messages, you can leave your index message on the tape to be heard by anyone who has your remote code.

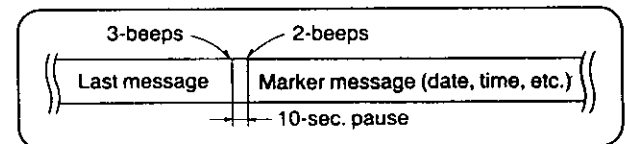

- 3 beep tones will be heard after the last message has been played, followed by a 10-second pause, and then 2 more beep tones.

- 1 Speak immediately after the last 2 beeps.

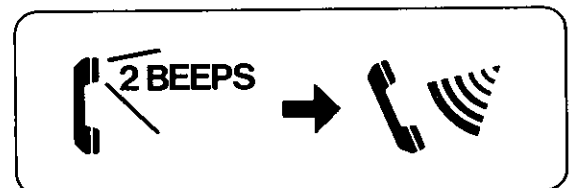

- 2 When you are finish, hang up.

How to Operate from a Remote Phone (cont.)

Remote Reset

To record new Incoming Messages from the beginning of the tape.

■ After the recorded messages have been played back or while they are playing back;

- 1 Push "3" and then hang up.

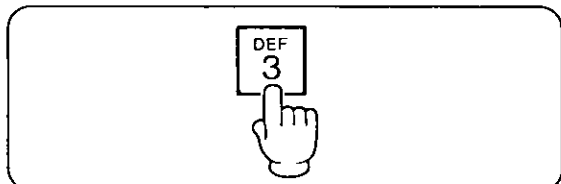

- The unit will rewind to the beginning of the tape and reset itself.

■ If you have used the Memory Playback;

- 1 Push "3".

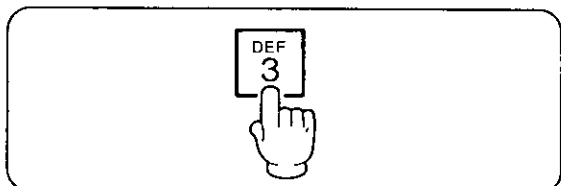

- The unit will rewind to the beginning of the newly recorded messages and a beep will be heard.

- 2 Push "3" again to advance to the beginning of the tape.

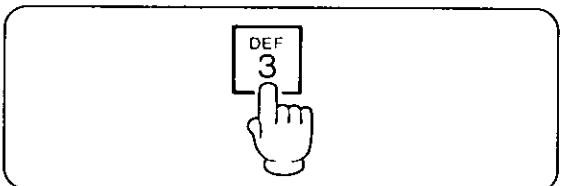

- A beep tone will be heard and future Incoming Messages will be recorded from the beginning of the tape.

■ To cancel the Remote Reset;

Push "2" after the tape has been reset (one beep).

Skipping OGM for ICM Recording

If you would like to leave a message on your unit, but do not want to listen to your Outgoing Message before doing so, you can switch directly to the Incoming Message (Recording) Mode.

- 1 Call your unit.

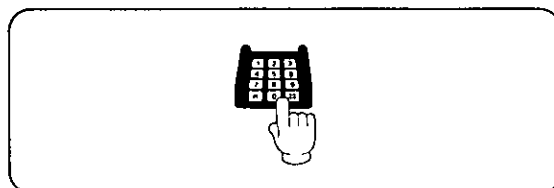

- 2 Push "0" during OGM (instead of your Code No.).

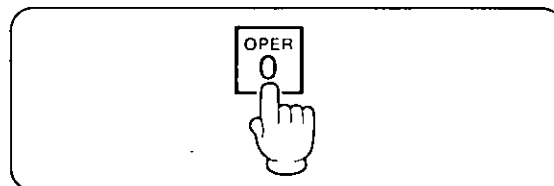

- One beep will be heard and the unit will go directly to the Incoming Messages mode.

- 3 After hearing a long beep, speak clearly and loudly to record your message.

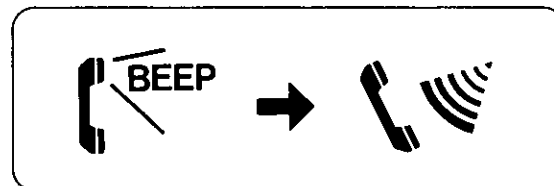

How to Operate from a Remote Phone (cont.)

Turning On the Speakerphone (Answer Back)

You may screen the room where the unit is installed for sound, by turning the speakerphone on remotely. You can speak with anyone in the room, even if they can not reach the unit.

1 Call your unit.

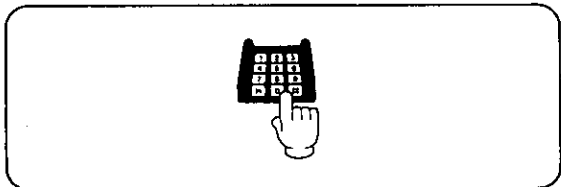

2 Push your **code No.** during OGM.

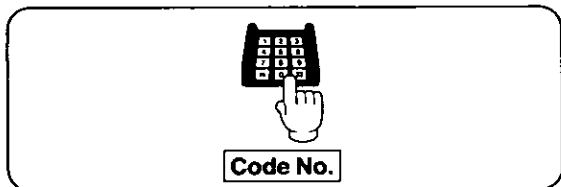

3 After hearing the beeps, push "6" immediately.

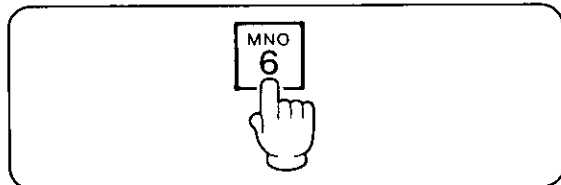

- The beeps indicate the number of recorded messages.
- The speakerphone of your unit will be turned on.
- You can monitor the room for 30 seconds.
- To monitor further, push "6" again within 10 seconds of the beep.

■ **If you want to talk to the other party in the room:**

Ask the other party to pick up the handset or push the SP-PHONE button, and start the conversation.

- If no one picks up the handset or pushes the SP-PHONE button, the line will terminate after 30 seconds.
- To use this Answer Back function, position the SPEAKER VOLUME control for normal use, otherwise it may be difficult for anyone to hear you from the speakerphone.

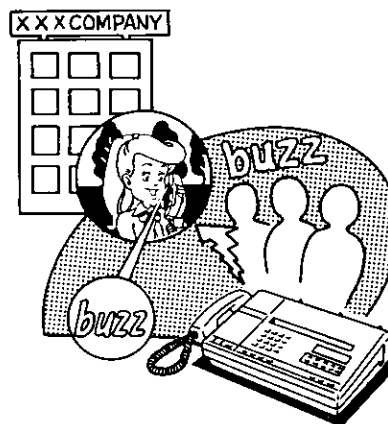

ANSWERING MACHINE

How to Operate from a Remote Phone (cont.)

Changing the OGM

You can record a new Outgoing Message from a remote phone.

1 Call your unit.

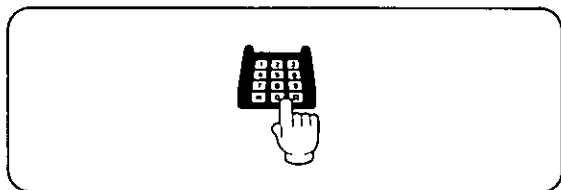

2 Push your **code No.** during OGM.

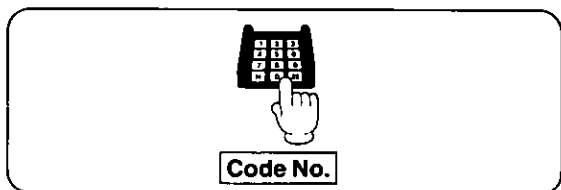

3 After hearing the beeps, push "7" immediately.

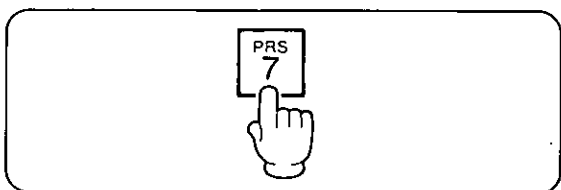

•The beeps indicate the number of recorded messages.

4 After hearing a long beep, speak clearly and loudly for up to 16 seconds.

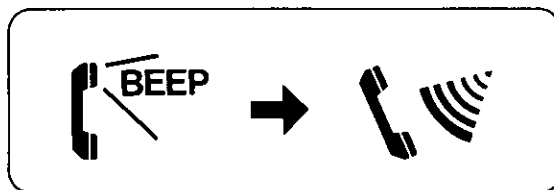

5 When you are finished, push "9".

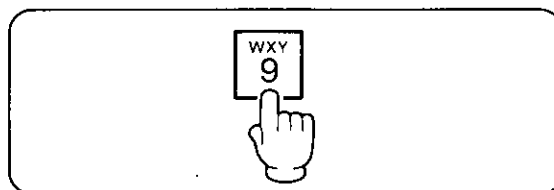

•The new Outgoing Message will be played back.

ANSWERING MACHINE

NOTES:

- In some areas, a remote tone phone may not function due to telephone line conditions such as line noise, echo, etc.
- The unit may not respond if tones produced by the telephone are too short.

QUICK REFERENCE CARD

FOR TONE REMOTE CONTROL

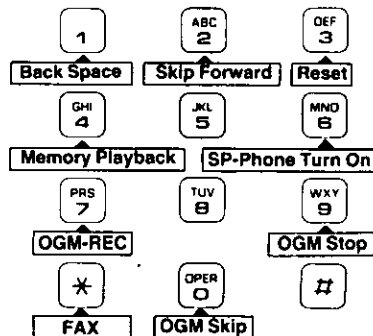

- To set to the Automatic Answer mode remotely
 1. Dial the phone number.
 2. Wait until 15 rings, and hang up after hearing OGM.
- To set to the FAX mode after recording message
 1. Push the button.
 - The "Beep" (answering carrier tone) will be heard.

How to Operate as a Telephone

Table of Contents

Manual Dialing and Reception	3-1
Making a Call	3-1
Receiving a Call	3-1
Redialing	3-1
Switching to Hands-free or Handset Operation during a Conversation	3-2
Handset to Hands-free	3-2
Hands-free to Handset	3-2
Speed Dialing and One-Touch Dialing	3-3
Programming the Phone Numbers for Speed Dialing	3-3
Programming the FAX/Phone Numbers for One-Touch Dialing	3-4
Dialing	3-5
Other Features	3-6
How to Store a Secret Phone Number	3-6
Mute Operation	3-7
Flash Button Usage	3-7
Tone Button Usage	3-7
Combination Dialing	3-7
Outside Line or Computer Accessed Line (Pause Usage)	3-7

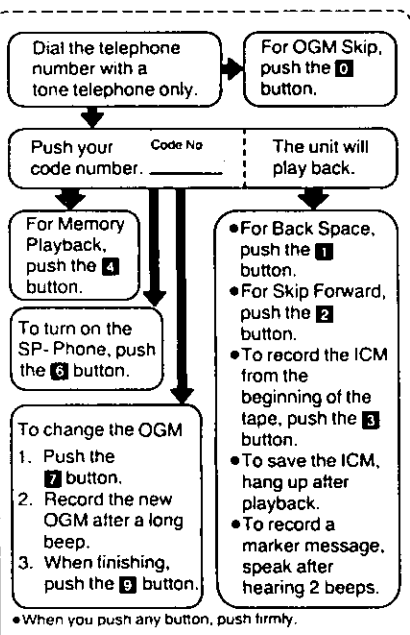

Manual Dialing and Reception

Making a Call

■ Using the Handset

- 1 Lift the handset and dial the phone number.
- 2 Speak with the other party.
- 3 Hang up the handset when finished.

■ On-hook Dialing

- 1 Push **SP-PHONE**.

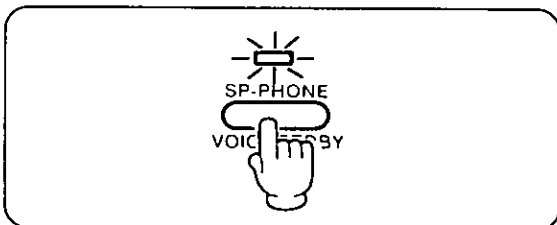

- The SP-PHONE indicator will light.

- 2 Dial the phone number and speak.

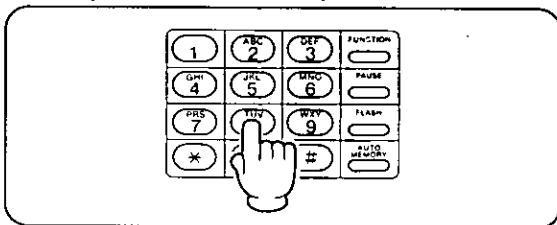

- The Display will show the dialed phone number.

- 3 When finished, push **SP-PHONE** again.

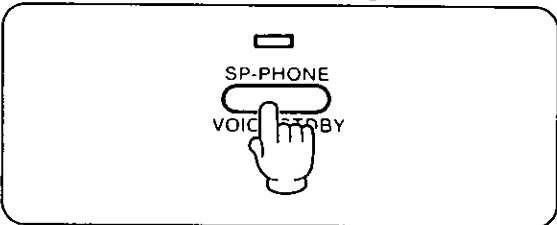

- The SP-PHONE indicator will go out.

Receiving a Call

- 1 Lift the handset or push **SP-PHONE** and speak.

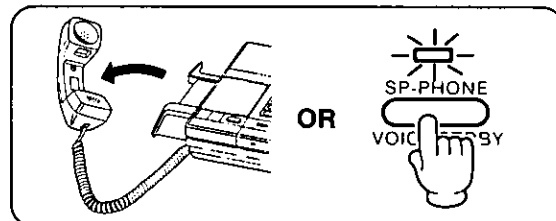

Redialing

You can redial the last dialed number by simply pushing the **REDIAL** button.

- 1 Push **REDIAL** if the line is busy.

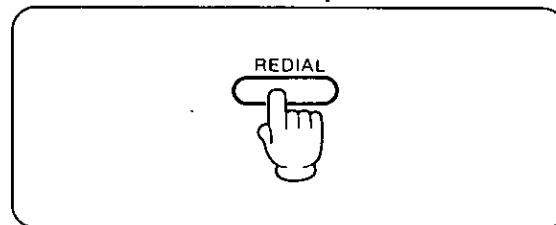

■ When using the handset:

Depressing the **REDIAL** button causes the last number to be redialed once.

■ When using the speakerphone: (Automatic Redialing)

The unit will automatically redial the last number dialed up to 15 times within a 10-minute period.

- The SP-PHONE indicator will blink slowly.
- During the pause between each redial, the display will show the following message.

REDIAL MODE

- To cancel the automatic redialing, push the **FLASH** button.

Switching to Hands-free or Handset Operation during a Conversation

You may choose to switch to the handset or the speakerphone during a conversation.

Handset → Hands-free Switch to

- 1 Push **SP-PHONE** and **continue speaking**.



- The SP-PHONE indicator will light.

- 2 **Replace the handset** onto the cradle.

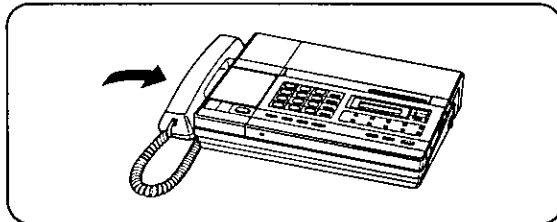

- If you replace the handset onto the cradle before pushing the SP-PHONE button, the conversation will be cut off.

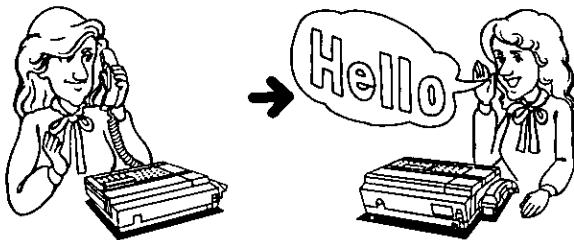

Hands-free → Handset Switch to

- 1 **Lift the handset** while speaking in a Hands-free Operation.

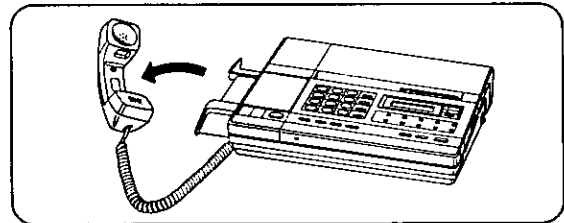

- The SP-PHONE indicator will go out.

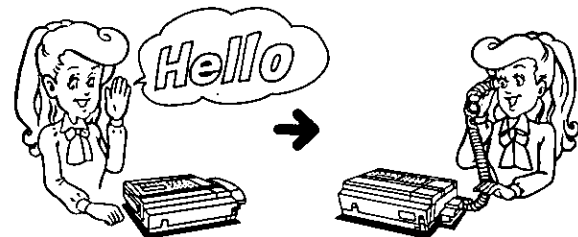

HELPFUL HINTS FOR HANDS-FREE:

- If it is difficult to hear the other party's voice when using the speakerphone:
Raise the sound level using the SPEAKER VOLUME control.
- Lower the sound level if the other party has difficulty hearing you.
- Absorbing echoes:
Use this unit in a room which has curtains or carpeting.
- To avoid lost or broken conversations:
If you and the caller speak at the same time, parts of your conversation will be lost. To avoid this, speak alternately.

Speed Dialing and One-Touch Dialing

SPEED DIALING:

The unit allows keys "0" to "9" on the dial pad to be used for an additional 100 memory stations. These stations can then be accessed by dialing two digits ("00" through "99"). Each station is capable of storing 30 digits.

ONE-TOUCH DIALING:

The unit is also equipped with ten One-Touch dialing stations (using the Direct Call buttons), each of which consists of two locations; Telephone and FAX Number. Each location (Telephone/FAX No.) is capable of storing 30 digits.

Programming the Phone Numbers for Speed Dialing

- Be sure that the handset is on the cradle and that the SP-PHONE button is off.

1 Push FUNCTION.

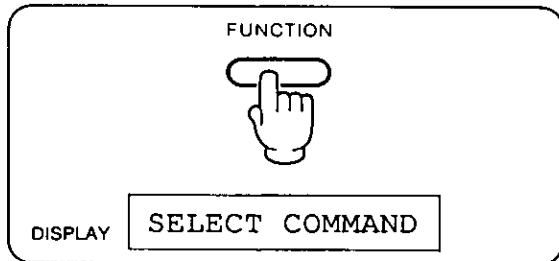

2 Enter the Station No. (00 to 99, 2 digits). (e.g. If the Station No. is 46.)

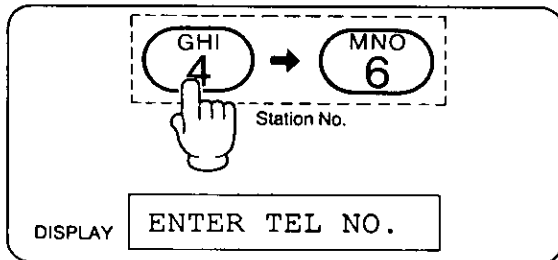

3 Enter the telephone number, then push AUTO/MEMORY. (e.g. Phone number is 234-5678.)

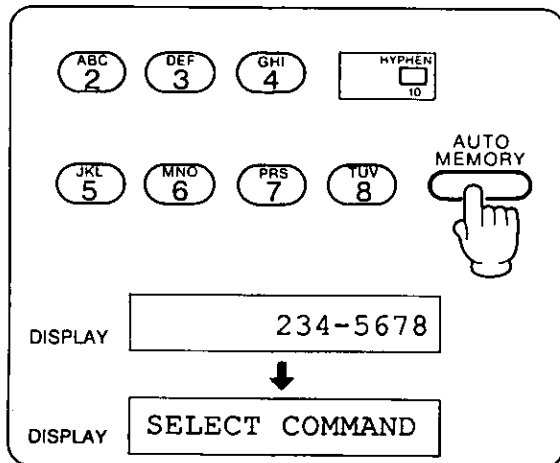

- The display will show the entered telephone number.
- To store phone numbers in succession, repeat steps 2 and 3.

4 Push FUNCTION to end the operation.

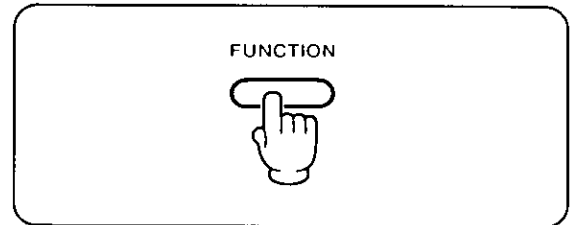

- You may also store FAX numbers into the Speed Dial keys similarly.

- **Correcting an error while programming:** Push the STOP/CLEAR button instead of pushing the AUTO/MEMORY button and then re-program the correct number.

- The new entry will be cleared and the previous storage will remain untouched.

- To print out the stored phone number, see page 1-17.

Speed Dialing and One-Touch Dialing (cont.)

Programming the FAX/Phone Numbers for One-Touch Dialing

- Be sure that the handset is on the cradle and that the SP-PHONE button is off.

1 Push **FUNCTION**.

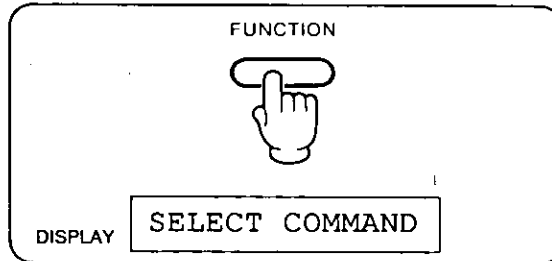

Storing Phone No.
(into the telephone number memory location)

2 Push a **DIRECT CALL** button.
(e.g. If the Direct station No. is 4.)

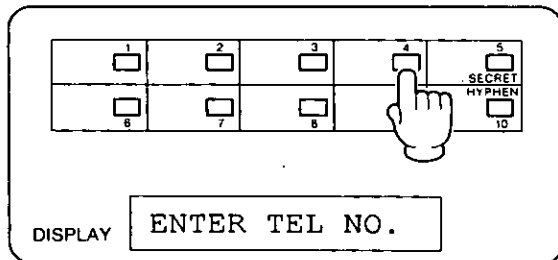

3 Enter the **telephone number**, then push **AUTO/MEMORY**. (e.g. Phone number is 123-4567.)

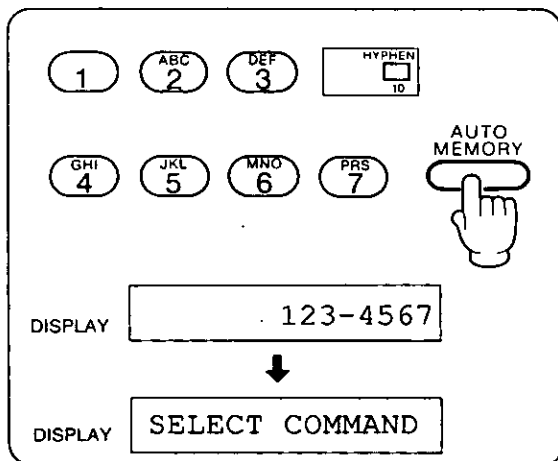

- The display will show the entered telephone number.
- To store telephone numbers in succession, repeat steps 2 and 3.

Storing FAX No.
(into the FAX number memory location)

2 Push a **DIRECT CALL** button, then push **MODE** to enter the FAX No. (e.g. If the Direct station No. is 4.)

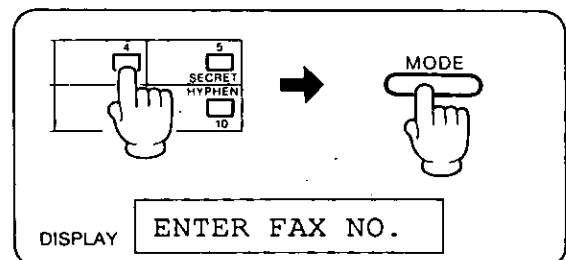

3 Enter the **FAX number**, then push **AUTO/MEMORY**. (e.g. Phone number is 765-4321.)

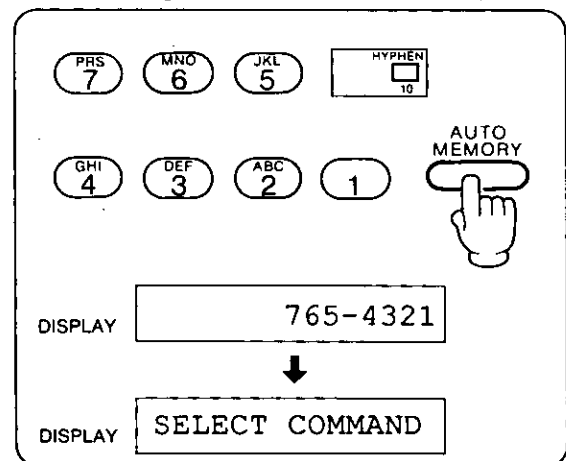

- The display will show the entered FAX number.
- To store FAX numbers in succession, repeat steps 2 and 3.
- After pushing the Direct Call button, you must push the MODE button to store a FAX number into the FAX memory location.

Speed Dialing and One-Touch Dialing (cont.)

- 4 Push **FUNCTION** to end the operation.

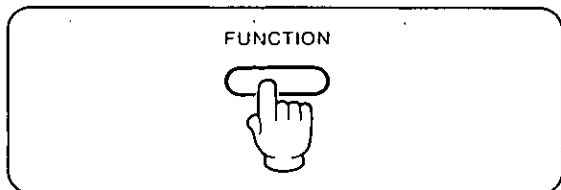

- **Correcting an error while programming:**
Push the **STOP/CLEAR** button instead of pushing the **AUTO/MEMORY** button and then re-program the correct number.

- If a number was previously stored at this location, it would remain intact.

- **To print out the stored numbers, see page 1-17.**

- **To erase the stored numbers:**

Example: To erase the number in memory station "02".

- 1 Push **FUNCTION**.

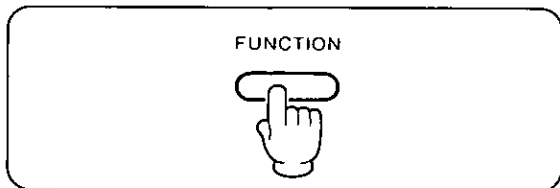

- 2 Push "02" and then **AUTO/MEMORY**.

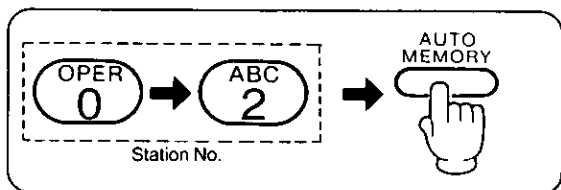

- 3 Push **FUNCTION** to end the operation.

- You can also erase the stored phone/FAX number for One-Touch Dialing by pushing the **DIRECT CALL** button instead of the memory station at step 2.

Be sure to push the **MODE** button after pushing the **DIRECT CALL** button when you erase the FAX number of the FAX memory location.

Dialing

- 1 Lift the handset or push **SP-PHONE**.

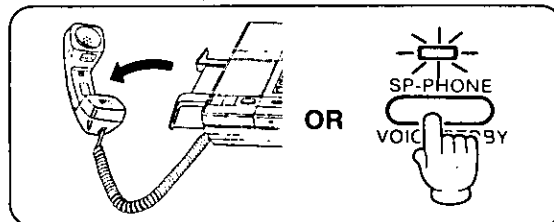

- 2 **Using Speed Dialing:**
Push **AUTO** and then push the **Station No.**
(e.g. If the Station No. is 12.)

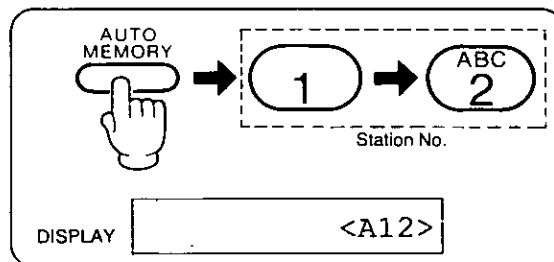

- "A" indicates Auto and "12" the speed dial No.

Using One-Touch Dialing:

Push **DIRECT CALL**.
(e.g. If the Direct station No. is 3.)

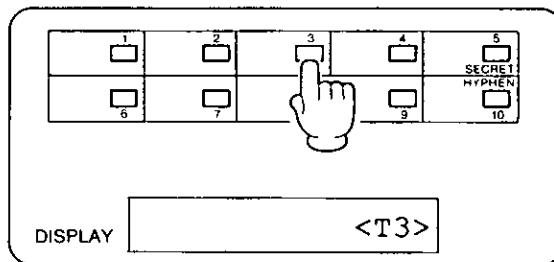

- "T" indicates telephone memory location and "3" the station No.

NOTE:

When you push the **DIRECT CALL** Button;

- If a document has been placed onto the **DOCUMENT** holder, the unit will dial the number using the **FAX** memory location. At this time, the LCD display will show "F".
- If the **DOCUMENT** holder is empty, the unit will dial the number using the telephone memory location.

Other Features

How to Store a Secret Phone Number

This function is useful for keeping a FAX/Phone No. (or a portion of it) secret, when you print out the list of phone numbers, using the Printout Function. (Refer to "Printout Function" on page 1-17.)

Be sure that the handset is on the cradle and that the SP-PHONE button is off.

Example:

Store the phone No. 123-4567 into the telephone memory location as a secret No.

1 Push FUNCTION.

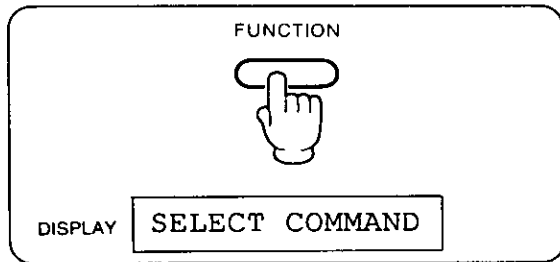

2 Push a DIRECT CALL button. (e.g. If the Direct station No. is 4.)

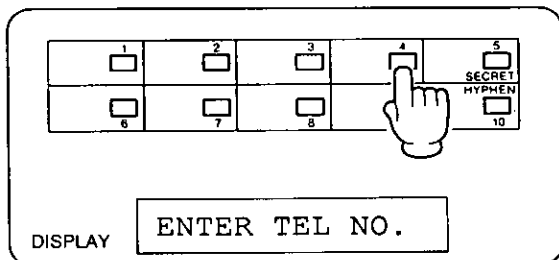

3 Enter the telephone number.

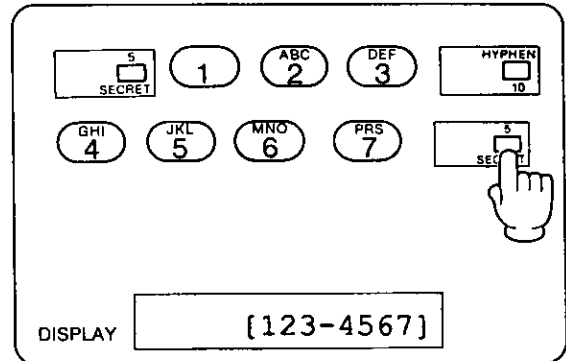

4 Push AUTO/MEMORY.

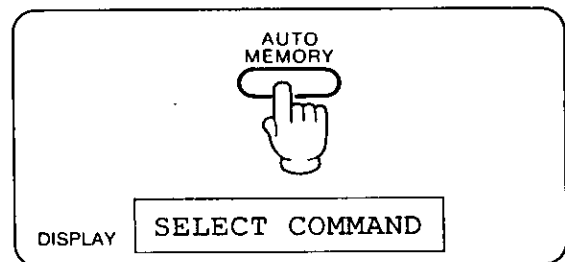

NOTE:

When you print out your list of phone number, the secret numbers will not be printed. (Refer to TEL LIST Example as shown below.)

[TEL LIST Example]

<< TELEPHONE NO. LIST >>

TEL NO

01 T123-4567

02 T321-8546

03 T[]

04 T951-5624

05

06

FAX NO

01 T452-6523

02 T784-6589

03 T126-5468

04 T841-5847

05

TELEPHONE

Other Features (cont.)

Mute Operation

Use this feature when you do not want your voice to be heard by the other party.

- 1 Push **MUTE**.

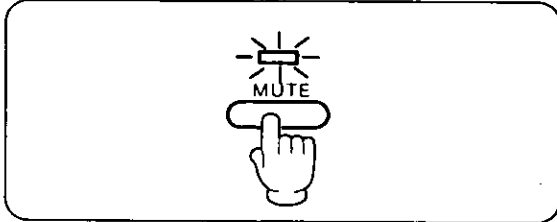

- The MUTE indicator will light.

■ To resume the conversation:

Push the MUTE button again.

- The MUTE indicator will go out.

Flash Button Usage

You can access some of the features of your host PBX by using the FLASH button instead of the Hookswitch. This is done by pushing the FLASH button lightly when required. "FLASH" can also be stored in memory the same as "Storing Phone Numbers" on page 3-3.

Tone Button Usage

If you wish to change from Pulse to Tone while dialing you may do so by pressing, the "**TONE (*)**" button instead of changing the DIALING MODE selector.

When you hang up, the unit will automatically return to the Pulse mode.

Combination Dialing

Any of the following dialing combination is possible.

- Automatic and Manual Dialing
- Pulse and Tone Dialing
- Plural Memory Stations

Outside Line or Computer Accessed Line (Pause Usage)

Using the PAUSE button function during a dial operation is helpful when accessing an outside line or a computer accessed long distance service.

- One pause is required when waiting for an outside dial tone.

Example (PBX):

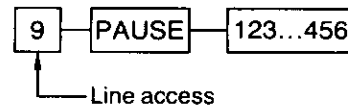

Some PBXs require this pause during an automatic redial.

- Two pauses are required when waiting for a computer tone from long distance service companies such as MCI, SPRINT, METRO and others.

Example:

Local access telephone number for the alternate long distance service company 123-5434,
Authorization no. 563478,
Long distance no. 901-210-9812

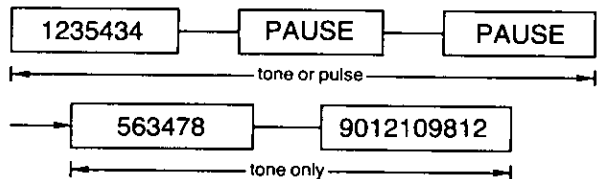

- The above numbers are used as examples only.

NOTE:

- Pushing the PAUSE button once counts as 1 digit.
- Pushing the TONE button counts as 1 digit. (Refer to "Tone button Usage".)

General Information

Table of Contents

Recording Paper Installation	4-1
Troubleshooting Guide	4-2
Glossary of Terms	4-5

Recording Paper Installation

Follow the steps below to install the recording paper.

Replace the recording paper roll when the end mark appears on the both sides of the paper (red line). When the roll is finished, your facsimile will stop receiving and the LCD Display will show;

OUT OF PAPER

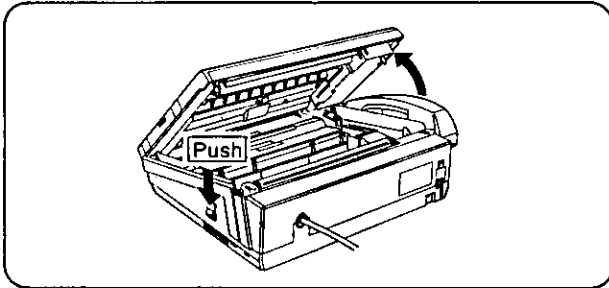

- 1 Push the LATCH button to open the cover.

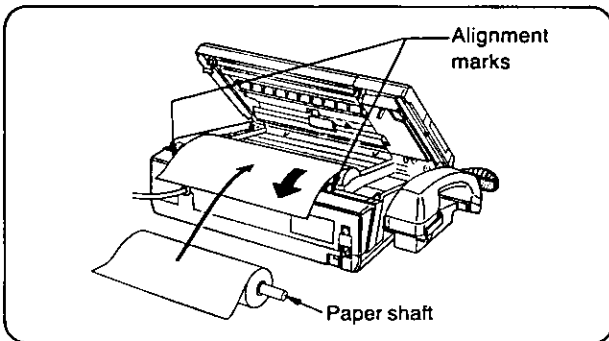

- 2 Insert the paper shaft into the recording paper (Panasonic KX-A101) and then insert the recording paper as shown so that it feeds from the top of the roll and a few inches of paper extend out of the unit.

- Align the recording paper with two Alignment marks.

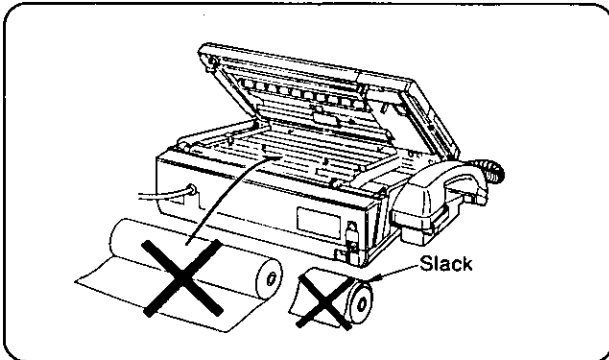

- 3 Make sure that the recording paper is correctly oriented. If it is reversed, no messages will be recorded.

- To record the messages properly, make sure that the recording paper is not slackened.

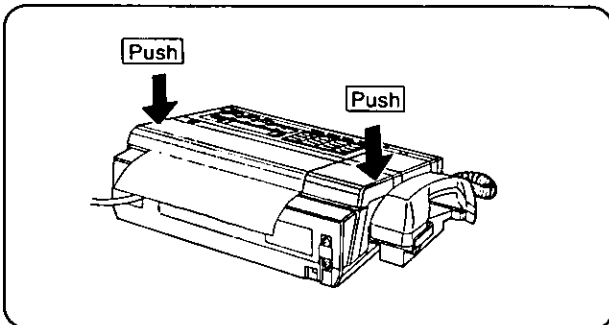

- 4 Close the cover carefully by pressing both ends gently.

- If the LCD Display shows the message below when you close the cover, close it again carefully.

CHECK COVER

Troubleshooting Guide

Error Messages

Cause & Remedy

CHECK COVER

If the message appears, close the cover again carefully.

OUT OF PAPER

When the recording paper is finished, replace it.

POWER FAILED

- When the AC cord is plugged.
- If a power failure occurs, this message will appear after the power is restored.

BATTERY LOW

If this message appears, the batteries have become weak and should be replaced.

CHECK OGM/BATT.

- The batteries should be replaced, since they are discharged.
- The OGM should be re-recorded and the present time should be reprogrammed, since they are erased.

CHECK MEMORY

If this message appears, Phone/Fax numbers and your selections are erased, since the built-in lithium battery has become weak. Consult with specified Panasonic Factory Servicenter.

SORRY, NO ANSWER

When the document does not transmit.
Try again.

CHECK DOCUMENT

- When you transmit a document which is longer than 600 mm, this message will appear. (The alarm may sound.) Open the cover and remove the document.
- If a document is jammed during transmission, this message will appear. Open the cover then remove the jammed document.

WAIT, OVERHEATED

When copying or receiving documents for a long time, the unit may overheat. (The ALARM indicator will light.) In this case, leave the unit alone and allow the unit to cool.

CHECK ICM TAPE

ICM tape is full. Push the REW button to reset the tape or use 2-side of the tape.

Troubleshooting Guide (cont.)

Problem	Cause & Remedy
FACSIMILE	
<p>The ALARM indicator lights during transmission.</p>	<ul style="list-style-type: none"> • Confirm whether the cover is closed completely or not. • When you transmit a document which is longer than 600 mm, the alarm may sound. Open the cover and remove the document. • If you have call waiting service, it may have been activated by another telephone call. Re-connect the unit to a line that does not have call waiting service.
<p>Recording image is scratchy and cannot be read completely.</p>	<p>The Sender transmitted a light density document. Have the other Sender darken the density of a document (e.g. by copying) then have them transmit it again.</p>
<p>The document is not pulled into the unit.</p>	<p>If the document is not properly inserted into the DOCUMENT holder, it may not be pulled into the feeder. Insert the document sufficiently until it stops.</p>
<p>The other party complains that documents are being received with distorted letters.</p>	<ul style="list-style-type: none"> • Someone may have used a telephone connected in parallel with the unit. • If you have call waiting service, it may have been activated by another telephone call. Re-connect the unit to a line that does not have call waiting service.
<p>The unit has been set the automatic Answer mode, but a document cannot be received automatically.</p>	<p>Confirm whether you have recorded the following OGM—"To send a FAX, push the asterisk button." or not. See page 1-5. If you cannot transmit, see page 1-6.</p>
<p>When using an automatic dialer (One-Touch Transmission), I cannot dial the other party's FAX number.</p>	<p>Confirm whether the FAX number has been stored into the FAX memory station or not. When you place your document into the unit, the unit will automatically select the FAX memory station.</p>
<p>The START/COPY indicator flashes for about 40 seconds after your unit receives a call automatically but nothing is recorded.</p>	<p>The caller hang up during or immediately after the playing of the OGM. This may occur if the disconnect single is not transmitted from the Central Office, and your unit is in normal condition.</p>
<p>The unit does not operate properly in telephone mode, answering machine mode and/or facsimile mode.</p>	<p>Push the RESET button. (found on the bottom of the unit) If the unit does not operate properly even if pushing the RESET button, unplug the AC cord and then plug it in again after 1 minute.</p>
<p>When I receive or copy a document whose background is very dark or containing photographs, the unit may produce a high tone.</p>	<p>This is quite normal.</p>

Troubleshooting Guide (cont.)

Problem

Cause & Remedy

ANSWERING MACHINE

The unit does not work when I push buttons. I cannot remove the cassette from the unit.	Push the RESET button. (found on the bottom of the unit) If the unit does not operate properly even if pushing the RESET button, unplug the AC cord and then plug it in again after 1 minute.
The unit has been set to the Automatic Answer mode, but no Incoming Messages have been recorded.	<ul style="list-style-type: none">• The microcassette is broken (cut, worn out or twisted) or not inserted. Replace the cassette with a new one.• The OGM is recorded improperly. Record a new OGM.• The AUTO/FAX selector is set to the "FAX" position. Change the selector to the "AUTO" position.
When the tape is played back, the sound level is low, even if the SPEAKER VOLUME control is turned up fully.	Clean the heads. (See "Maintenance" on page 17 in INSTALLATION MANUAL.)
I have played back all the recorded messages and I want to record the next phone call after the last previously recorded messages.	When the AUTO ANSWER indicator starts blinking, wait for 7 seconds. When the AUTO ANSWER indicator is off, push the AUTO ANSWER button. The unit will be ready to record next phone call.
I push the buttons of a remote phone, but the unit does not respond.	<ul style="list-style-type: none">• Make sure that you are using the correct code number.• Record the Outgoing Message in a quiet place.
Some Incoming Messages have not been fully recorded.	Set the CPC to "B". (See "Initial Preparation" on page 8 in INSTALLATION MANUAL.)

TELEPHONE

The unit does not ring.	<ul style="list-style-type: none">• The RINGER VOLUME selector is set to "OFF". Should be set to "HIGH" or "LOW".
The caller suddenly cannot hear my voice during a conversation.	Look at the MUTE indicator. If it is lit, push the MUTE button to resume the conversation.

Glossary of Terms

One-Touch Transmission:

By placing the document onto the DOCUMENT holder and pushing the DIRECT CALL button, the unit will automatically dial the number in the FAX memory location and transmit the document.

JOURNAL: This is a report of the transmissions and receptions.

TX REPORT:

Individual Transmission Report

Each time a document is transmitted, this function will cause a record of the transmission to be printed.

OGM: Outgoing Message

ICM: Incoming Message

CPC: Calling Party Control
Calling party control enables the unit to detect when a caller hangs up.

Automatic Answer Mode:

When a call is received, the unit will automatically answer, record voice messages and/or received documents.

AUTO-LOGIC (One-Touch Operation):

At the touch of the PLAYBACK/PAUSE button, the unit will automatically rewind, playback all the recorded messages and stop. After 7 seconds, the unit will reset itself to the Automatic Answer Mode.

VOX: Voice Activated Circuit
The caller can leave a message for any length of time for as long as he/she continues to speak.

FLASH: If you connect your unit to PBX, you may access some features of your PBX by using the FLASH button instead of the hookswitch.

The following sections can be found in INSTALLATION MANUAL.

- Connection
- Battery Installation
- Recording Paper Installation
- Cassette Tape Installation
- Document Tray Installation
- Installation of the Card for Speed Dialing
- Initial Preparation
- Setting the Day and Time
- Setting the Logo and/or Identification (ID) Number
- Programming the Function
- Service Function for Facsimile
- Printer and Motor Test
- Maintenance
- Telephone Line Connection
- Cassette Tape
- Others
- Important Information
- Accessory Order Information
- For Your Future Reference
- Specifications of Facsimile
- Service Center Directory
- Warranty

Panasonic Company
Division of Matsushita Electric Corporation of America
One Panasonic Way, Secaucus, New Jersey 07094

Panasonic Hawaii, Inc. ("PHI")
99-859 Iwaiwa Street, Honolulu, Hawaii 96808-0774

Panasonic Sales Company ("PSC"),
Division of Matsushita Electric of Puerto Rico, Inc.
Ave. 65 De Infanteria, KM 9.7 Victoria Industrial Park, Carolina, Puerto Rico 00630

Free Manuals Download Website

<http://myh66.com>

<http://usermanuals.us>

<http://www.somanuals.com>

<http://www.4manuals.cc>

<http://www.manual-lib.com>

<http://www.404manual.com>

<http://www.luxmanual.com>

<http://aubethermostatmanual.com>

Golf course search by state

<http://golfingnear.com>

Email search by domain

<http://emailbydomain.com>

Auto manuals search

<http://auto.somanuals.com>

TV manuals search

<http://tv.somanuals.com>