

Panasonic

Operating Instructions

Compact Plain Paper FAX

Model No. **KX-FP181E**

Compact Plain Paper FAX with
Telephone Answering System

Model No. **KX-FP185E**

Multi-Function Plain Paper FAX

Model No. **KX-FM189E**



The pictured model is KX-FP181.

Please read these Operating Instructions before using the unit and save for future reference.

This model is only designed to be used in the United Kingdom and Ireland.

IMPORTANT

Panasonic

WARRANTY REGISTRATION
PLEASE FAX BACK TO REGISTER FOR YOUR
12 MONTHS WARRANTY

Thank you for purchasing your Panasonic facsimile. By filling in the section below, this will ensure the following:

- We will register your unit on our warranty database. Should you ever require a service call under warranty, your call will be dealt with quickly and efficiently.
- We will send you a reply fax to confirm your registration and the correct operation of your unit.
- If you have any problems, please call our customer helpline on 08701 580560 for UK. For Republic of Ireland, please refer to place of purchase.

Simply, follow these instructions:

1. Please fill in the section below in block capitals and in ink.

Your name

Company name (if applicable)

Your address

Your postcode

Telephone no. Fax no.

Model no.

Serial no. Date of purchase Day Month Year

- 2. Fax this form to **08701 583250** and we will fax back to confirm receipt of your details. Please allow 14 working days for this. In addition, we will also send you information of our maintenance contracts.**

TERMS AND CONDITIONS

1. This warranty is in addition to and does not in any way affect any statutory or other right of consumer purchasers. This warranty relates only to product used within Mainland Great Britain, please refer to your dealer for warranty information relating to use elsewhere within the United Kingdom.
2. This product is designed for use only on the United Kingdom and Ireland's Public Switched Telephone Network and should be used only for normal purposes and in accordance with standard operating instructions.
3. You should complete the registration form overleaf and fax it to us within 7 days of purchase; failure to do so may result in delays in providing warranty service.
4. This warranty covers breakdowns due to design or manufacturing faults; it does not apply to damage, however caused, wear or tear, neglect, incorrect adjustment or repair, or to any items of limited natural life.
5. This warranty does not cover consumables i.e. ink films, film refills, ink cartridges, paper and paper loads or any optional accessories which may have been purchased either at the same time, as or subsequent to, the main unit. Such accessories should be returned to the point of purchase if found to be faulty.
6. In the event of a failure, please take the following action;
 - a. Refer to the "Help" section of your instruction manual in order to identify and possibly correct the problem;
 - b. If the fault cannot be resolved and you require a trained operator, please contact our customer helpline on 08701 580560 for UK.
For Republic of Ireland, please refer to place of purchase.
7. In the event the helpline cannot resolve the problem, a like for like exchange fax will be dispatched overnight (if the call is received before 4pm) or, by a mutually convenient arrangement. The helpline operator will give you specific instructions on how the exchange will be executed. Failure to comply with these instructions may result in delay and cost to you.
8. The exchange fax will be delivered in a customised case by courier. It is the customer's responsibility to promptly remove the exchange fax and insert the faulty fax in the case provided for collection, to enable the courier to return it to Panasonic.
9. The exchange fax is to be regarded as a like for like exchange under warranty and the balance of the warranty period will transfer to the exchange unit.
The liability of Panasonic under the terms of this warranty is limited to the exchange of the fax, or the repair and return of the original fax (subject to any additional charges, see Condition 4).
10. Where the original fax is found to be faulty as a result of unauthorised repairs or modifications or damage either by accident, misuse or improper installation then Panasonic reserves the right to charge the customer the sum of £50.00 plus Vat, as a contribution towards repair costs.
11. This warranty applies to the original purchaser only and is not transferable.
12. The warranty period applicable to this product shall be 12 months from the date of purchase.

Fax to 08701 583250

Thank you for purchasing a Panasonic facsimile.

Welcome to the world of Panasonic facsimiles.

This product combines various facsimile and telephone features to provide you with more efficient office or home use. By utilising these convenient features, you can maximise the effectiveness of this unit.

For your future reference

Date of purchase

Serial number

(found on the rear of the unit)

Dealer's name and address

Dealer's telephone number

Model difference

Model \ Features	Facsimile, Telephone and Copier	Answering Device	Scanner, PC-Fax and Printer
KX-FP181	Available	Not available	Not available
KX-FP185	Available	Available	Not available
KX-FM189	Available	Available	Available

Caution:

- Note that the images of copied or received documents will remain on the used ink film. Use discretion when disposing of the used ink film.
- Do not rub or use an eraser on the printed side of recording paper, as the print may smear.
- In the event of problems, you should contact your equipment supplier in the first instance.
- This equipment is designed for use on the UK and Republic of Ireland analogue telephone network.

Note:

- A suffix "E" in the model number is omitted in these instructions.
- Most figures shown in these operating instructions are based on a KX-FP181.

Copyright:

This manual is copyrighted by Kyushu Matsushita Electric Co., Ltd. (KME) and its licensee. Under the copyright laws, this manual may not be reproduced in any form, in whole or part, without the prior written consent of KME and its licensee.

© Kyushu Matsushita Electric Co., Ltd. 2000

Important safety instructions

When using this unit, basic safety precautions should always be followed to reduce the risk of fire, electric shock, or personal injury.

1. Read and understand all instructions.
2. Follow all warnings and instructions marked on this unit.
3. Unplug this unit from power outlets before cleaning. Do not use liquid or aerosol cleaners. Use a damp cloth for cleaning.
4. Do not use this unit near water, for example near a bath tub, wash bowl, kitchen sink, or the like.
5. Place the unit securely on a stable surface. Serious damage and/or injury may result if the unit falls.
6. Do not cover slots and openings on the unit. They are provided for ventilation and protection against overheating. Never place the unit near radiators, or in a place where proper ventilation is not provided.
7. Use only the power source marked on the unit. If you are not sure of the type of power supplied to your home, consult your dealer or local power company.
8. For safety purposes this unit is equipped with a grounded plug. If you do not have this type of outlet, please have one installed. Do not use any type of adaptor plug to defeat this safety feature.
9. Do not place objects on the mains lead. Install the unit where no one can step or trip on the cord.
10. Do not overload wall outlets and extension cords. This can result in the risk of fire or electric shock.
11. Never push any objects through slots in this unit. This may result in the risk of fire or electric shock. Never spill any liquid on the unit.
12. To reduce the risk of electric shock, do not disassemble this unit. Take the unit to an authorised service centre when service is required. Opening or removing covers may expose you to dangerous voltages or other risks. Incorrect reassembly can cause electric shock when the unit is subsequently used.
13. Unplug this unit from the wall outlet and refer servicing to an authorised service centre when the following conditions occur:
 - A. When the power supply cord or plug is damaged or frayed.

- B. If liquid has been spilled into the unit.
 - C. If the unit has been exposed to rain or water.
 - D. If the unit does not work normally by following the operating instructions. Adjust only controls covered by the operating instructions. Improper adjustment may require extensive work by an authorised service centre.
 - E. If the unit has been dropped or physically damaged.
 - F. If the unit exhibits a distinct change in performance.
14. During thunderstorms, avoid using telephones except cordless types. There may be a remote risk of an electric shock from lightning.
 15. Do not use this unit to report a gas leak, when in the vicinity of the leak.

SAVE THESE INSTRUCTIONS

INSTALLATION

1. Never install telephone wiring during a lightning storm.
2. Never install telephone jacks in wet locations unless the jack is specifically designed for wet locations.
3. Never touch uninsulated telephone wires or terminals unless the telephone line has been disconnected at the network interface.
4. Use caution when installing or modifying telephone lines.

WARNING

- To prevent the risk of fire or electrical shock, do not expose this product to rain or any type of moisture.

OTHER INFORMATION

- Keep the unit away from electrical noise generating devices, such as fluorescent lamps and motors.
- The unit should be kept free from dust, high temperature and vibration.
- The unit should not be exposed to direct sunlight.
- Do not place heavy objects on top of this unit.
- Do not touch the plug with wet hands.

Table of Contents

Initial Preparation

Accessories	Included accessories	6
	Accessory information	6
Help Button	Help function	7
Finding the Controls	Location	8
	Overview	10
Setup	Removing the information leaflet	10
	Recording paper load	10
	Recording paper	11
	Connections	12
	Date and time, your logo and facsimile telephone number	13
Volumes	Adjusting volumes	17

Telephone

Making and Answering Calls	Voice calls - making	18
	Voice calls - answering	18
	RECALL and PAUSE buttons	19
EASY DIAL	Storing names and telephone numbers in the EASY DIAL directory	20
	Making a voice call using the EASY DIAL directory	23
Caller ID (KX-FP185 KX-FM189 only)	Caller ID service from your phone company	24
	Calling back using caller information	26
	Storing caller information in the EASY DIAL directory	27
	Erasing caller information	28
Voice Contact	Talking to the other party after fax transmission or reception	29

Fax

Sending Faxes	Sending a fax manually/using the EASY DIAL directory	30
	Sending a fax with the voice guide (KX-FP185/KX-FM189 only)	33
	Sending from memory	33
	One time broadcast transmission	34
	Broadcast transmission to pre-programmed parties	35
Receiving Faxes	Setting the unit to receive faxes	38
	TEL mode (answering all calls manually)	40
	FAX ONLY mode (all calls are received as faxes)	41
	Using the unit with an answering machine (KX-FP181 only)	42
	To use with a computer	43
	TEL/FAX mode (receiving voice calls with rings and fax calls without rings when you are near the unit)	44
	Turning the AUTO ANSWER mode on remotely	46
	Extension telephone	47
	Receive polling (retrieving a fax placed on another fax machine)	48
	Pager call	49

Copy

Copying	Making a copy	50
----------------	-------------------------	----

Answering Device (KX-FP185/KX-FM189 only)

Setup	TAD/FAX mode (using the built-in answering device and receiving voice and fax calls automatically)	52
Greeting	Pre-recorded greeting messages	53
	Recording your own greeting messages	54
	Erasing your own recorded greeting messages	55
Incoming Messages	Listening to recorded messages	56
	Erasing recorded messages	57
Recording	Memo message (leaving a message for others or yourself)	58
	Telephone conversation	58
Remote Operation	Operating from a remote location	59
	Operation from a remote touch tone telephone	60
Option	Transferring recorded messages to another telephone	62

Programmable Features

Features Summary	Programming	64
	Basic features	65
	Advanced features	67

Help









Error Messages	Reports	72
	Display	73
Operations	When a function does not work, check here before requesting help	75
	If a power failure occurs	79
Jams	Recording paper jam	80
	Sending document jams	81
	Sending document does not feed, or multi-feeds	81
Cleaning	Document feeder	82
	Thermal head	82
Ink Film	Replacing the ink film	83

General Information

Print Reports	Reference lists and reports	85
Specifications	Technical data about this product	86
Important Information	Important Information	87
	Fitting a plug to the mains lead	88
	Condition of guarantee	89
Index	Index	90

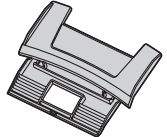
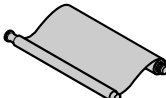
Accessories

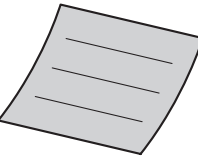
Included accessories

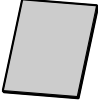
<p>Mains lead1</p>  <p>Order No. PQJA10039Z</p>	<p>Telephone line cord.....1</p>  <p>Order No. PQJA87S</p>	<p>Handset1</p>  <p>Order No. PFJXE0905Z (For KX-FP181/ KX-FM189) PFJXE0901Z (For KX-FP185)</p>	<p>Handset cord1</p>  <p>Order No. PFJA1029Z (For KX-FP181/ KX-FM189) PFJA1029Y (For KX-FP185)</p>	<p>Recording paper load..1</p>  <p>Order No. PFKS1043Z1 (For KX-FP181/ KX-FM189) PFKS1043Z2 (For KX-FP185)</p>
<p>Ink film1 (complimentary test ink film)</p>  <p>—The ink film is pre-installed.</p>	<p>Operating Instructions1</p>  <p>Order No. PFQX1520Z</p>	<p>Quick Start Sheet....1</p>  <p>Order No. PFQW1495Z</p>	For KX-FM189 only	
			<p>Panasonic PC Software for KX-FM189.....1 (CD-ROM)</p>  <p>Order No. PFJKFM189E</p>	<p>PANA LINK Software Guide ...1</p>  <p>Order No. PFQX1525Z</p>

- If any items are missing or damaged, check with the place of purchase.
- The part numbers listed above are subject to change without notice.
- Save the original carton and packing materials for future shipping and transportation of the unit.

Accessory information

Panasonic Accessories and Consumables DIRECT

- Order accessory and consumable items for all Facsimile Products with ease and confidence either by going on line through our Internet Accessory ordering application at www.panasonic.co.uk.
- Or telephone our Customer Care Centre on **08701 580560 Mon - Friday 9:00am - 5:30pm**
- Most major credit and debit cards accepted.
- All enquires transactions and distribution facilities are provided directly by Panasonic UK Ltd.
- It couldn't be simpler!

• KX-FP181 only

- When using the unit with an external answering machine (p. 42), please purchase an extension telephone adaptor by contacting one of the above or a local Panasonic authorised dealer.
- The complimentary test ink film is 10 metres long, and will print about 28 A4 size pages. We recommend that you buy full size replacement film – 50 metres for continuous use of your unit. For best results, use genuine Panasonic replacement film Model No. KX-FA55X.

Model No.	Item	Specifications
KX-FA55X	Replacement film	2 rolls – 216 mm x 50 m

Note:

- **The ink film is not reusable. Do not rewind and use the ink film again.**

Help function

You can print a quick reference for assistance as follows.

1 Press **HELP**.

Display:

2 Rotate **EASY DIAL** until the desired item is displayed.

■ For KX-FP181

1. How to set the date, time, your logo and fax number

2. How to program the features

3. How to store names in the EASY DIAL directory and how to dial them

4. Help with problems receiving faxes

5. How to use the copier function

6. List of available reports

3 Press **SET**.

■ For KX-FP185/KX-FM189

1. How to send faxes with the voice guide

2. How to set the date, time, your logo and fax number

3. How to program the features

4. How to store names in the EASY DIAL directory and how to dial them

5. Help with problems operating the answering device

6. Help with problems receiving faxes

7. How to use the copier function

8. List of available reports

9. How to use the Caller ID service

3 Press **SET**.

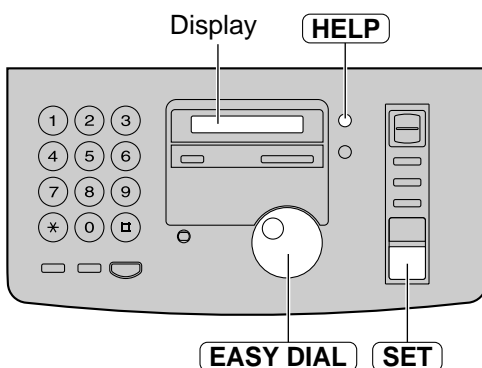

Finding the Controls

Location

■ For KX-FP181

- To scan and store a document into memory, and then transmit or copy the stored document (p. 33, 50).

- To choose "Collated" (sorted) in the copy mode (p. 50).

- To adjust volumes (p. 17).

- To select an enlargement/reduction rate in the copy mode (p. 50, 51).

- To print a quick reference (p. 7).

- For voice muting (p. 18).

- To turn on/off the AUTO ANSWER mode (p. 38, 39).

- To initiate or exit programming.

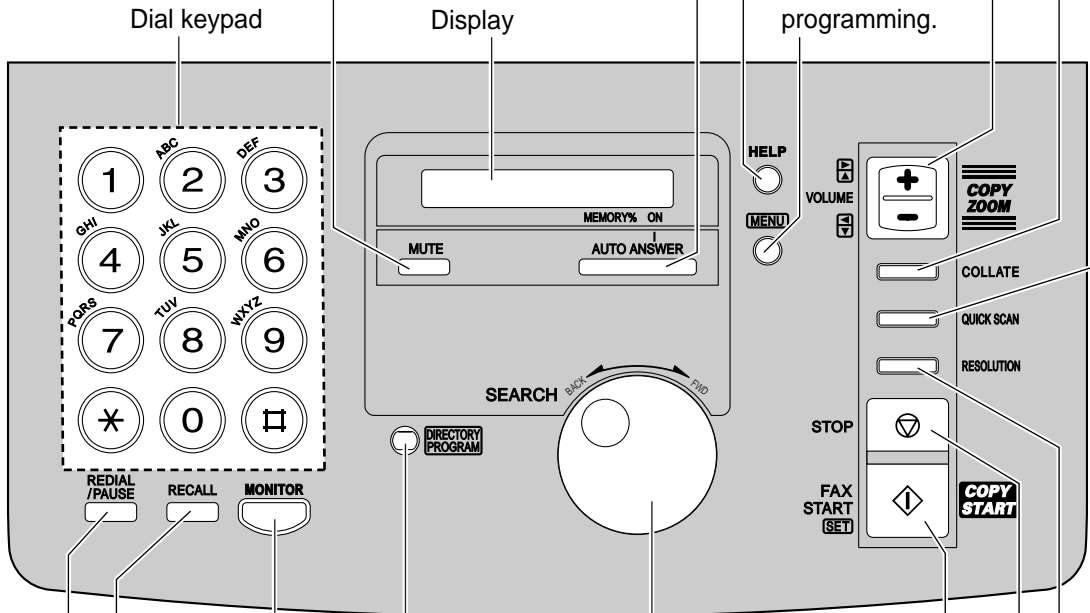

- To dial without lifting the handset.

- To use the recall feature (p. 19)

- To redial the last number dialled (p. 18, 31).

- To insert a pause during dialling (p. 19).

- To store or edit names and telephone numbers (p. 20, 22).

- To search for a stored name (p. 23, 30).

- To select the features/feature settings during programming (p. 64).

- To stop an operation or cancel programming.

- To initiate fax transmission, reception or copying.

- To store a setting during programming.

- To select a resolution (p. 30).

Finding the Controls

■ For KX-FP185/KX-FM189

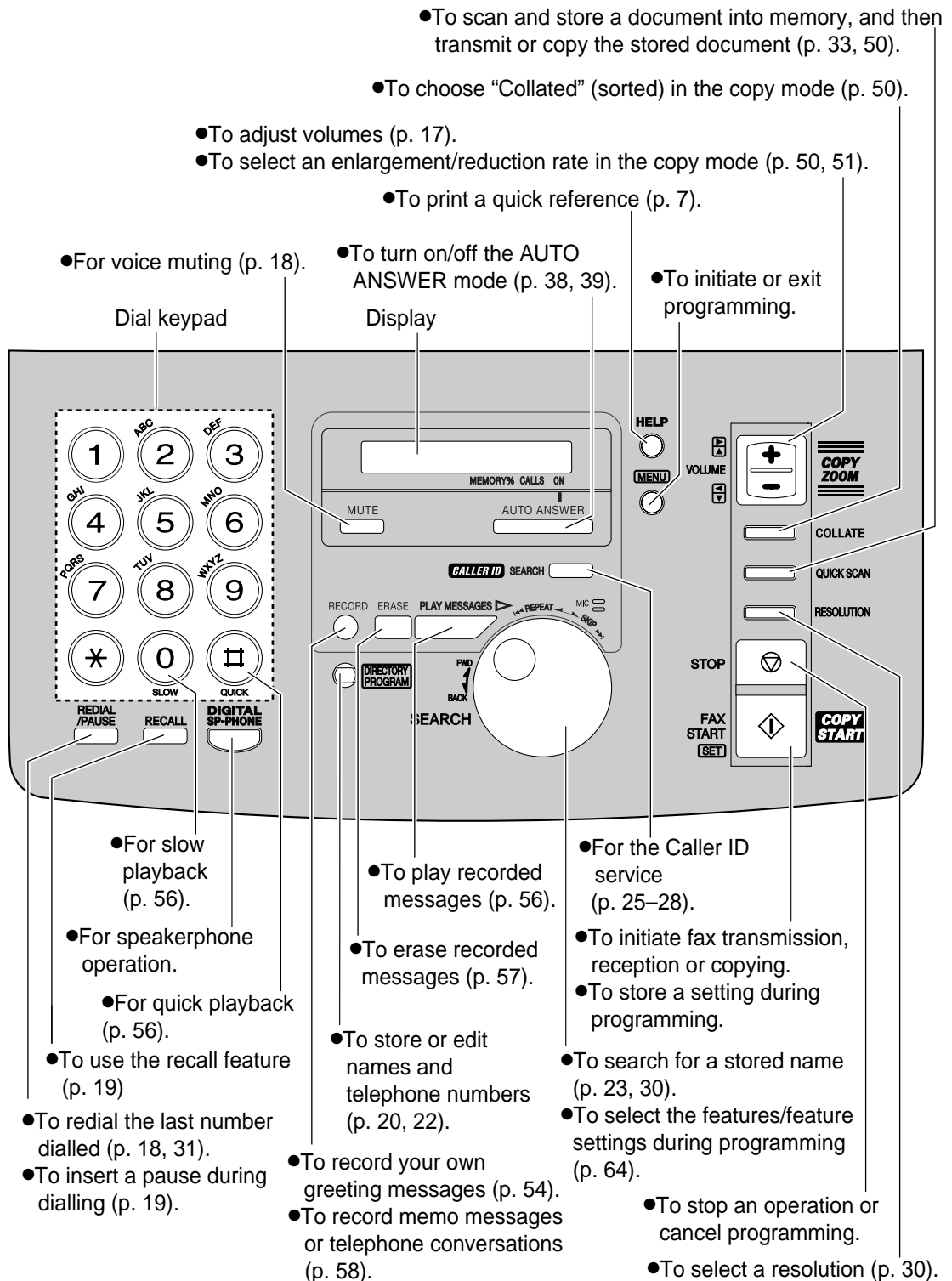

Finding the Controls / Setup

Overview

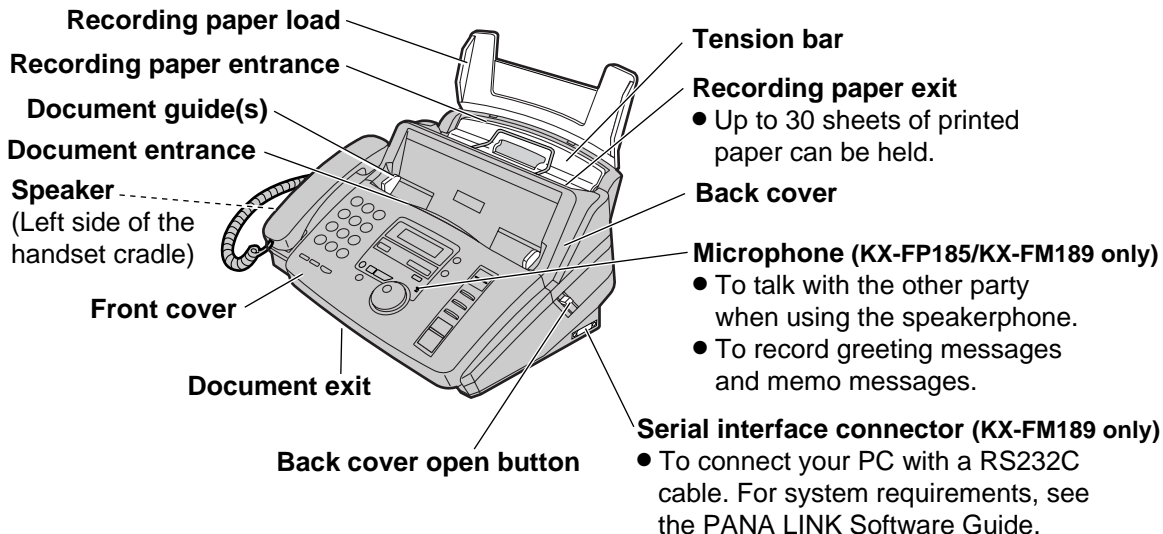

* The pictured model is KX-FM189.

Note:

- The document will be ejected from the front of the unit. Install the unit on a desk or floor with a smooth surface and do not place anything in front of the unit.

Removing the information leaflet

- 1 Open the front cover by pulling up the centre part.
- 2 Remove and read the information leaflet.
- 3 Close the front cover securely.

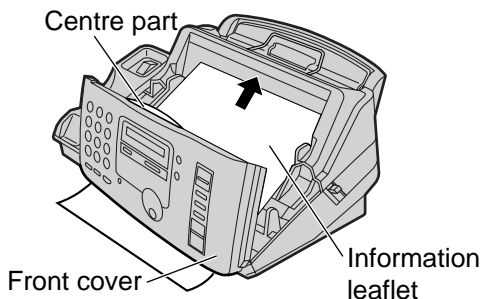

Recording paper load

Insert one tab on the recording paper load into one slot on the back of the unit (①) and then insert the other tab into the other slot (②).

Note:

- Do not place the unit in areas where the recording paper load may be obstructed by a wall, etc.

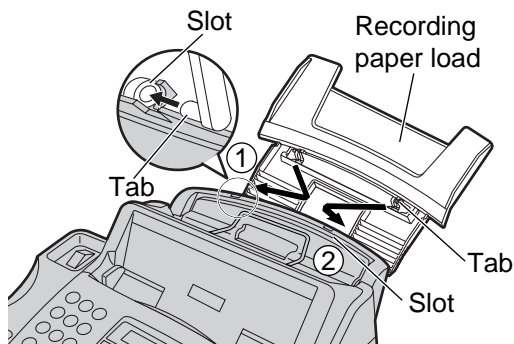

Recording paper

A4 size recording paper (210 mm x 297 mm) can be loaded. The unit can hold up to 50 sheets of 60 g/m² to 75 g/m² paper or 30 sheets of 90 g/m² paper.

- 1** Fan the stack of paper to prevent a paper jam.
- 2** Pull the tension bar forward and hold open while inserting the paper.
 - The paper should not be over the tab.
 - If the paper is not inserted correctly, readjust the paper or the paper may jam.

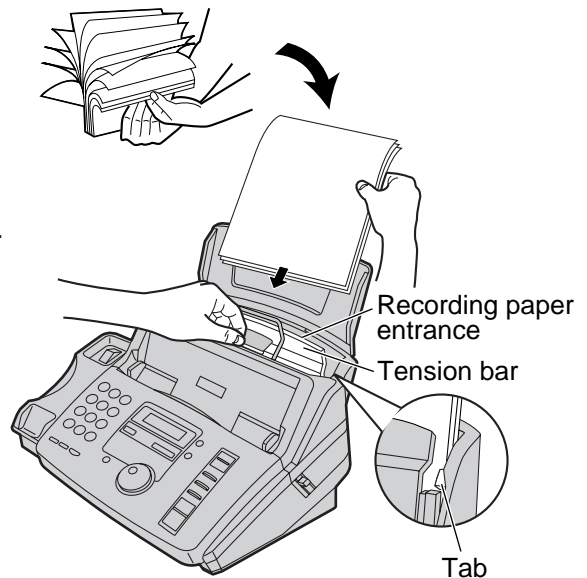
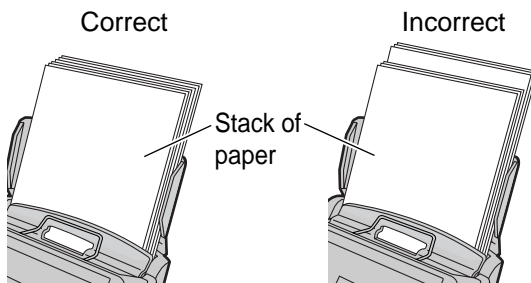

Note for recording paper:

- Avoid paper with a cotton and/or fiber content that is over 20%, such as letterhead paper or paper used for resumes.
- Do not use different types or thicknesses of paper at the same time. This may cause a paper jam.
- Avoid extremely smooth or shiny paper that is highly textured.
- Avoid paper that is coated, damaged or wrinkled.

Note:

- Avoid double-sided printing.
- Do not use paper printed from this unit for double-sided printing with other copiers or printers, or the paper may jam.
- Some paper only accepts print on one side. Try using the other side of paper if you are not happy with the print quality.

Adding paper

1. Pull the tension bar forward and hold open while removing all of the installed paper.
2. Add paper to the removed paper and straighten.
3. Fan the stack of paper.
4. Pull the tension bar forward and hold open while inserting the paper.

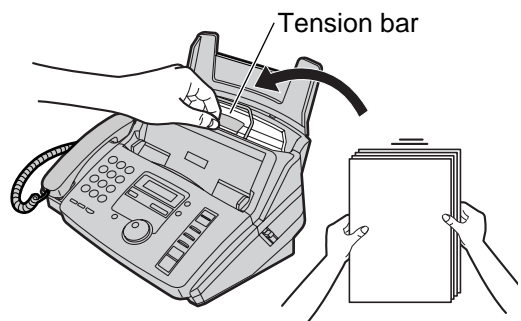

Setup

Connections

- 1 Connect the handset cord.
- 2 Connect the telephone line cord.
- 3 Connect the mains lead.
 - When the power is turned on for the first time, the unit will print some basic information.

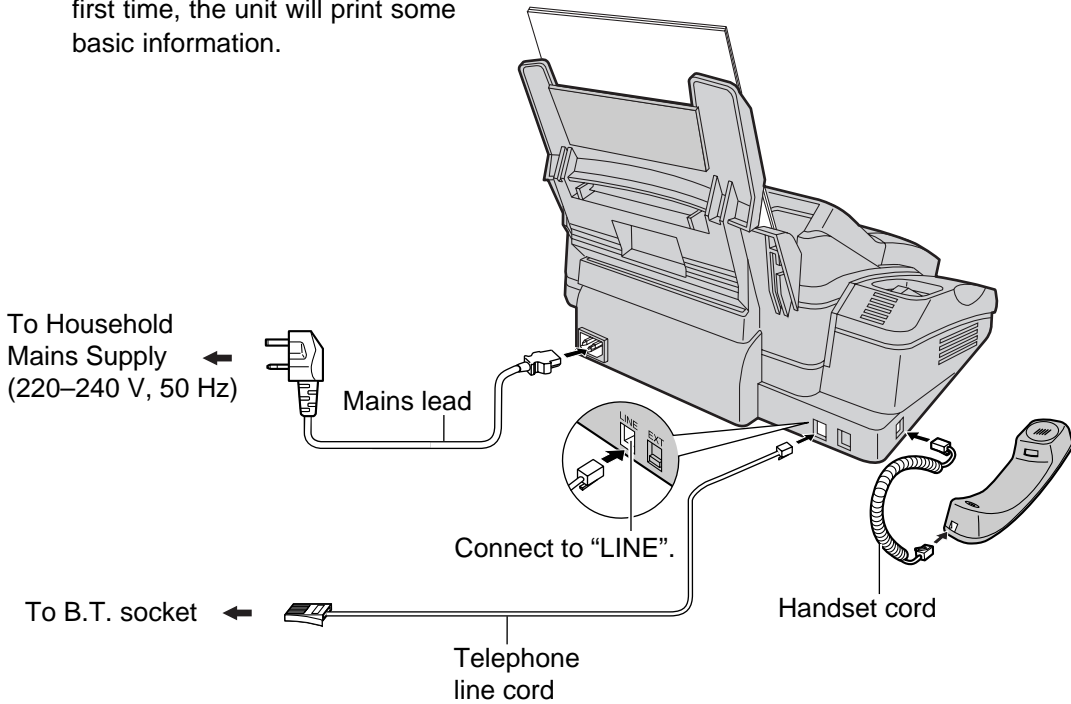

Note:

- When you operate this product, the power outlet should be near the product and easily accessible.
- If you want to connect an answering machine to the unit, see page 42 (KX-FP181 only).
- Telephone line connection is TNV (Telecommunication Network Voltage).

•KX-FP181 only

You can connect an extension telephone or answering machine to the external telephone jack (EXT) on this unit (p. 42, 47). A voltage drop of 1.15 V at 40 mA will be introduced between the EXT jack and the B.T. socket. If you have difficulty in making a call or experience problems during a telephone conversation, consult your dealer or our service personnel.

Date and time, your logo and facsimile telephone number

You should program the date and time, your logo and facsimile telephone number. This information will be printed on each page transmitted from your unit.

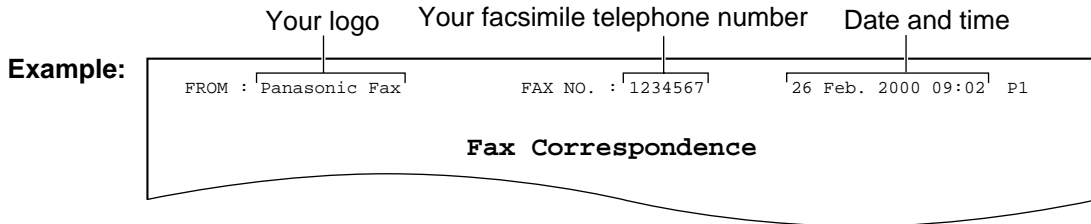

Setting the date and time

1 Press **MENU** .
 Display: 1.SYSTEM SET UP

2 Press **#**, then **0 1** .
 SET DATE & TIME

3 Press **SET** .
 D:01/M:01/Y:00
 Cursor

4 Enter the correct day/month/year by selecting 2 digits for each, using the dial keypad.
Example: 10 Aug., 2000
 Press **1 0 0 8 0 0** .

D:10/M:08/Y:00

5 Press **SET** .
 TIME: 00:00

6 Enter the correct hour/minute by selecting 2 digits for each, using the dial keypad.
Example: 15:15
 Press **1 5 1 5** .

TIME: 15:15

7 Press **SET** .
 SETUP ITEM []

8 Press **MENU** .

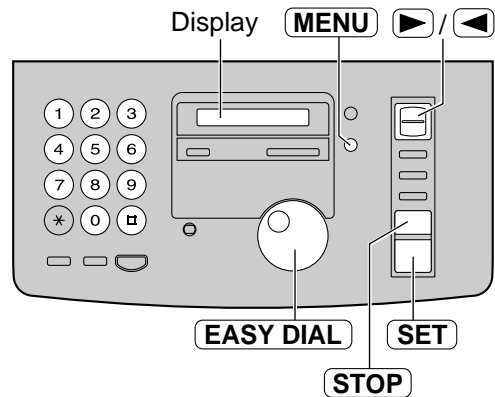

Note:

- You can enter your number by rotating **EASY DIAL** in steps 4 and 6. In this case, press **▶** to move the cursor.
- The accuracy of the clock is approximately ± 60 seconds a month.

To correct a mistake

- Press **▶** or **◀** to move the cursor to the incorrect number, and make the correction.
- If you press **STOP** while programming, the display will return to the previous one.

Setup

Setting your logo

The logo can be your company, division or name.

1 Press **MENU**.
Display: 1.SYSTEM SET UP

2 Press **#**, then **0 2**.
YOUR LOGO

3 Press **SET**.
LOGO=

4 Enter your logo, up to 30 characters, using the dial keypad. See next page for details.

Example: Bill

1. Press **2** twice.

LOGO=B
Cursor

2. Press **4** six times.

LOGO=Bi

3. Press **5** six times.

LOGO=Bi

4. Press **▶** to move the cursor to the next space and press **5** six times.

LOGO=Bill

5 Press **SET**.
SETUP ITEM []

6 Press **MENU**.

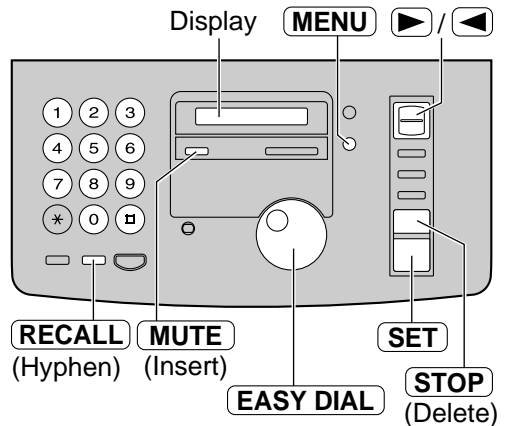

Note:

- You can enter your logo by rotating **EASY DIAL** (see next page).

To correct a mistake

- Press **▶** or **◀** to move the cursor to the incorrect character, and make the correction.

To delete a character



- Move the cursor to the character you want to delete and press **STOP**.

To insert a character

- Press **▶** or **◀** to move the cursor to the position to the right of where you want to insert the character.
- Press **MUTE** (Insert) to insert a space and enter the character.

To select characters with the dial keypad

Pressing the dial keys will select a character as shown below.

Keys	Characters
①	1 [] { } + - / = , . _ ` : ; ?
②	A B C a b c 2
③	D E F d e f 3
④	G H I g h i 4
⑤	J K L j k l 5
⑥	M N O m n o 6
⑦	P Q R S p q r s 7
⑧	T U V t u v 8
⑨	W X Y Z w x y z 9
⑩	0 () < > ! " # \$ % & ¥ * @ ^ ' →
RECALL	Hyphen button (To insert a hyphen.)
MUTE	Insert button (To insert one character or one space.)
STOP	Delete button (To delete a character.)
	▶ key (To move the cursor to the right.) To enter another character using the same number key, move the cursor to the next space.
	◀ key (To move the cursor to the left.)

To select characters using the EASY DIAL

Instead of pressing the dial keys, you can select characters using the EASY DIAL.

1. Rotate **EASY DIAL** until the desired character is displayed.
2. Press  to move the cursor to the next space.
 - The character displayed in step 1 is inserted.
3. Return to step 1 to enter the next character.

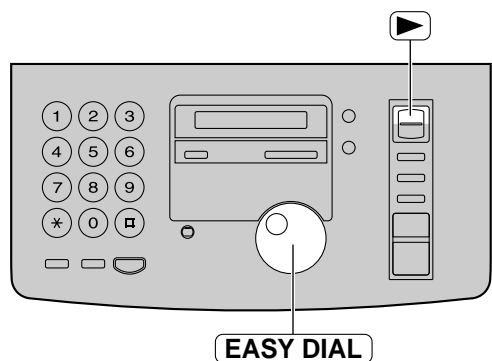

Display order of characters

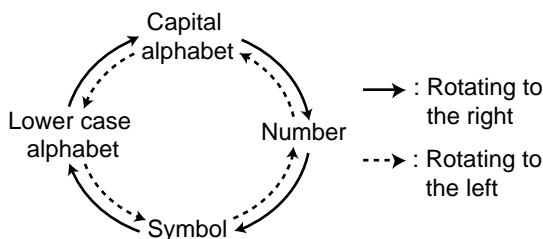

Setup

Setting your facsimile telephone number

1 Press **MENU**.

Display: 1.SYSTEM SET UP

2 Press **▣**, then **0 3**.

YOUR FAX NO.

3 Press **SET**.

NO. =

4 Enter your facsimile telephone number, up to 20 digits, using the dial keypad.

Example: NO. = 1234567

5 Press **SET**.

SETUP ITEM []

6 Press **MENU**.

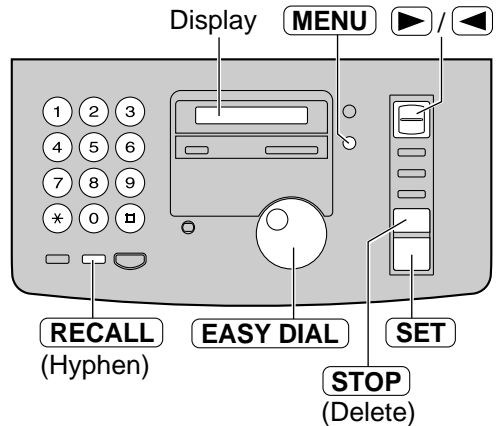

Note:

- You can enter your facsimile telephone number by rotating **EASY DIAL**. If using **EASY DIAL**, press **▶** to move the cursor.
- The ***** button replaces the digit with a "+" and the **▣** button replaces it with a space.
Example (using the dial keypad): +234 5678
Press ***234▣5678**.
- To enter a hyphen in a telephone number, press **RECALL** (Hyphen).

To correct a mistake

- Press **▶** or **◀** to move the cursor to the incorrect number, and make the correction.

To delete a number

- Move the cursor to the number you want to delete and press **STOP**.

Adjusting volumes

Ringer volume

4 levels (high/middle/low/off) are available.

While the unit is idle, press ▲ or ▼.

■ To turn the ringer off:

1. Press ▼ repeatedly until the following message is displayed.

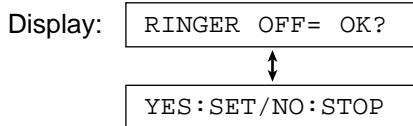

2. Press SET.

- To turn the ringer back on, press ▲.

■ While the ringer volume is set to off:

The display will show the following message.

RINGER OFF

When a call is received, the unit will not ring and will display the following.

INCOMING CALL

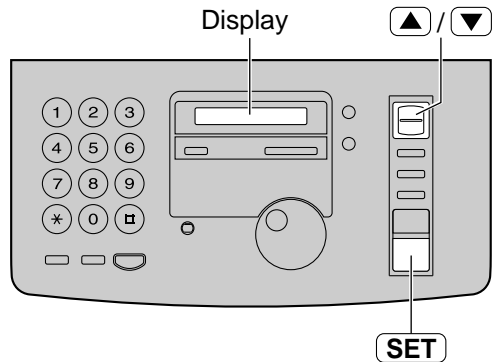

Monitor/Speaker volume

8 levels (high to low) are available.

While using the monitor/speakerphone, press ▲ or ▼.

Fax voice guidance volume

(KX-FP185/KX-FM189 only)

9 levels (high to off) are available.

While listening to the fax voice guidance, press ▲ or ▼.

Answering device volume

(KX-FP185/KX-FM189 only)

9 levels (high to off) are available.

While listening to the recorded messages, press ▲ or ▼.

Making and Answering Calls

Voice calls - making

- 1 Press **MONITOR** / **DIGITAL SP-PHONE** or lift the handset.
- 2 Dial the telephone number.
Example:
 - If you misdial, hang up and dial again.
- 3 When the other party answers, talk into the microphone (KX-FP185/KX-FM189) or speak with the handset.
- 4 When finished talking, press **DIGITAL SP-PHONE** (KX-FP185/KX-FM189) or replace the handset.

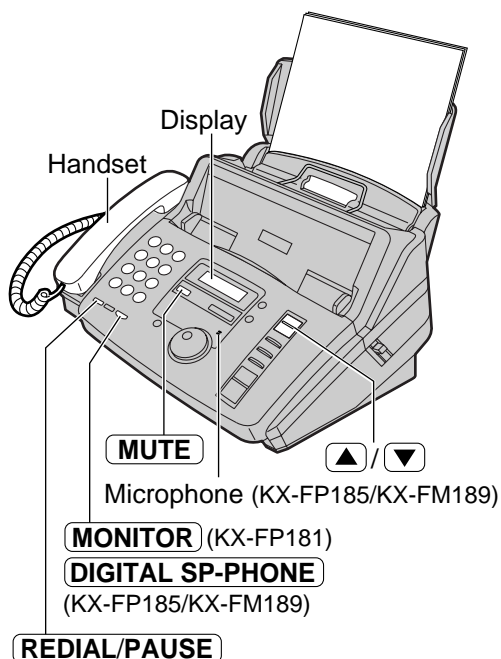

Voice calls - answering

- 1 When the unit rings, press **DIGITAL SP-PHONE** (KX-FP185/KX-FM189) or lift the handset.
- 2 When finished talking, press **DIGITAL SP-PHONE** or replace the handset.

To redial the last number

1. Lift the handset.
2. Press **REDIAL/PAUSE**.
3. When the other party answers, speak with the handset.
 - If the line is busy when using the **MONITOR** / **DIGITAL SP-PHONE** button, the unit will automatically redial the number up to 5 times.
 - During redial, the following will be displayed.

Display:

To mute your voice to the other party

1. Press **MUTE** during a telephone conversation using **DIGITAL SP-PHONE** or the handset.
Display:
 - The other party cannot hear you, but you can hear them.
2. To resume the conversation, press **MUTE** again.

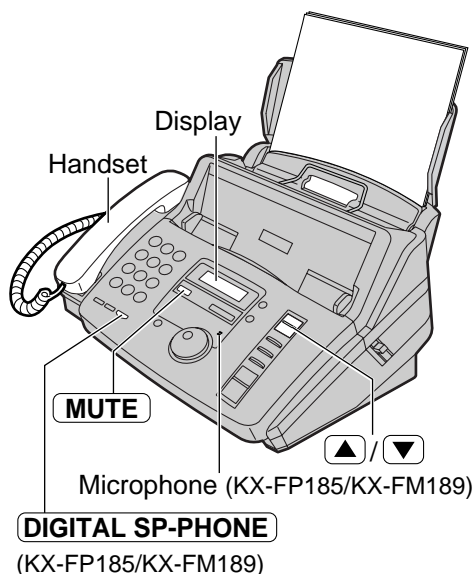

Speakerphone operation

(KX-FP185/KX-FM189 only)

- Use the speakerphone in a quiet room.
- Adjust the speakerphone volume using **▲** or **▼**.
- To switch to the handset, lift the handset. To switch back to the speakerphone, press **DIGITAL SP-PHONE**.

RECALL and PAUSE buttons

RECALL button (to use the recall feature)

RECALL is used to access special telephone services (optional) such as call waiting. Contact your telephone company business office for details.

Example: British Telecom call waiting

1. If the call waiting tone is heard during a conversation, press **RECALL**.
2. When the dial tone is heard, dial **2**.
 - The first call is put on hold and you can talk to the second party.
3. ■ **To keep the present call and return to the first call:**
Press **RECALL**, then dial **2**.
 - **To hang up the first call:**
Press **RECALL**, then dial **0**.
 - **To hang up the present call and return to the first call:**
Press **RECALL**, then dial **1**.

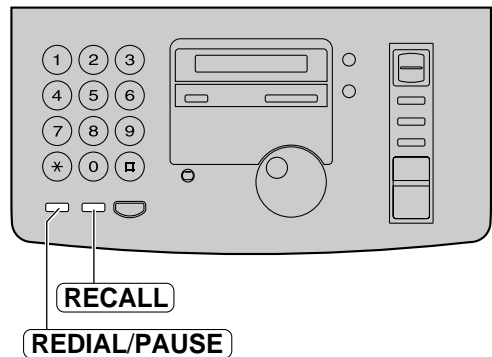

Note:

- PAUSE can be stored into a telephone number in the EASY DIAL directory.

If your unit is connected to a PBX, pressing **RECALL** allows you to access some features of your host PBX such as transferring an extension call.

PAUSE button (for PBX users)

If your unit is connected to a PBX, you need to dial an access number (usually 9) to get an outside line. In this case, inserting a pause between the access number and the telephone number is necessary, especially when redialling or storing the number into memory. Pressing **REDIAL/PAUSE** creates a dialling delay in the dialling sequence.

Example 1:

If your unit is connected to a host exchange, insert a pause to get an outside line.

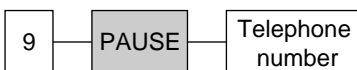

Line access code

Example 2:

If a transmission error occurs during an overseas transmission, add two pauses at the end of the telephone number.

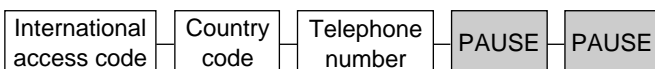

Storing names and telephone numbers in the EASY DIAL directory

For rapid access to frequently dialed numbers, the unit provides a EASY DIAL directory (100 stations).

1 Press **DIRECTORY PROGRAM** .

Display:

↓

2 Rotate **EASY DIAL** until the following is displayed.

3 Enter the name, up to 10 characters, by following the instructions on the next page.

Example:

4 Press **SET** .

5 Enter the telephone number, up to 30 digits, using the dial keypad.

Example:

- If you want to enter a hyphen, press **RECALL** .

6 Press **SET** .

↓

- To program other items, repeat steps 3 to 6.

7 Press **DIRECTORY PROGRAM** to exit the program.

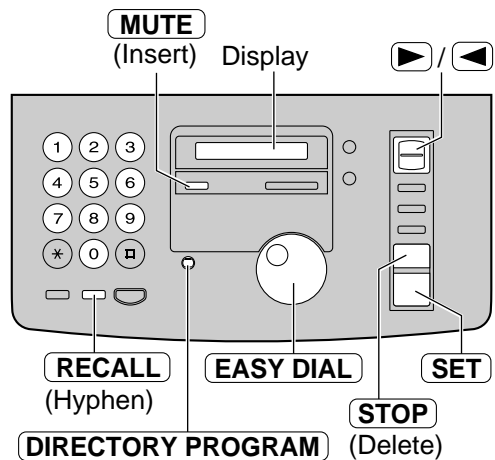

Helpful hint:

- You can confirm the stored items on the display (p. 23) or on the telephone number list (p. 85).

Note:

- When the following message is displayed in step 6, you can only store 5 more items.

Display:

- If there is no space to store new stations, the following message is displayed in step 1.

Erase unnecessary stations (p. 22).

- A hyphen or a space entered in a telephone number counts as two digits.

To correct a mistake



- Press **▶** or **◀** to move the cursor to the incorrect character/number, and make the correction.

To delete a character/number

- Move the cursor to the character/number you want to delete and press **STOP** .

To select characters with the dial keypad

Pressing the dial keys will select a character as shown below.

Keys	Characters
①	1 [] { } + - / = , . _ ` : ; ?
②	A B C a b c 2
③	D E F d e f 3
④	G H I g h i 4
⑤	J K L j k l 5
⑥	M N O m n o 6
⑦	P Q R S p q r s 7
⑧	T U V t u v 8
⑨	W X Y Z w x y z 9
⑩	0 () < > ! " # \$ % & ¥ * @ ^ ' →
RECALL	Hyphen button (To insert a hyphen.)
MUTE	Insert button (To insert one character or one space.)
STOP	Delete button (To delete a character.)
	▶ key (To move the cursor to the right.) To enter another character using the same number key, move the cursor to the next space.
	◀ key (To move the cursor to the left.)

To select characters using the EASY DIAL

Instead of pressing the dial keys, you can select characters using the EASY DIAL.

1. Rotate **EASY DIAL** until the desired character is displayed.
2. Press  to move the cursor to the next space.
 - The character displayed in step 1 is inserted.
3. Return to step 1 to enter the next character.

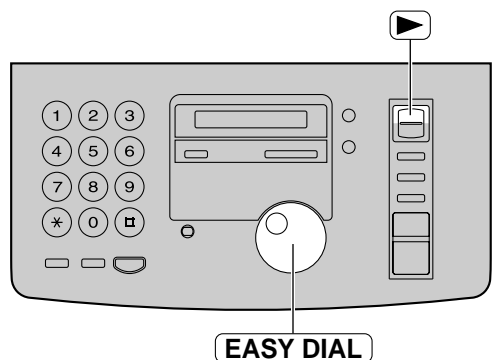

Display order of characters

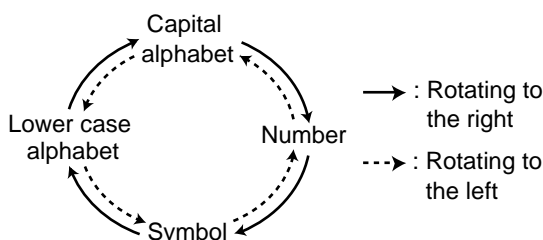

Editing a stored name and number

- 1** Rotate **EASY DIAL** until the desired name is displayed.

Example:

- 2** Press **DIRECTORY PROGRAM**.

- 3** Press ***** to select "EDIT".

- If you do not need to edit the name, skip to step 5.

- 4** Edit the name by following the instructions on page 21.

- 5** Press **SET**.

Example:

- If you do not need to edit the telephone number, skip to step 7.

- 6** Edit the telephone number. For further details, see page 20.

- 7** Press **SET**.

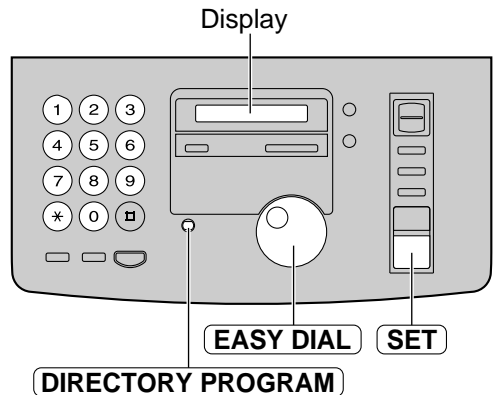

Erasing a stored name and number

- 1** Rotate **EASY DIAL** until the desired name is displayed.

Example:

- 2** Press **DIRECTORY PROGRAM**.

- 3** Press **#** to select "DELETE".



- To cancel erasing, press **STOP**.

- 4** Press **SET**.

- The stored name and number are deleted.

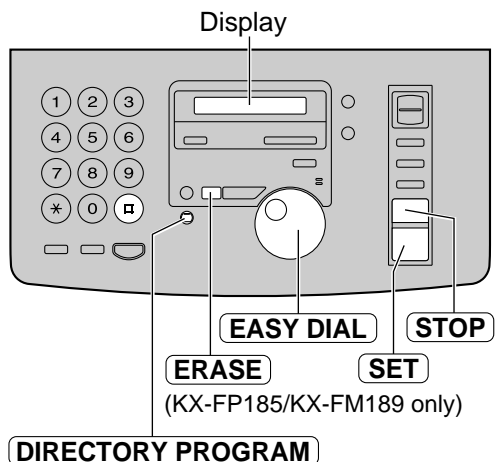

Note:

- You can use the following method to erase (KX-FP185/KX-FM189 only).

1. Rotate **EASY DIAL** until the desired name is displayed.
2. Press **ERASE**.
3. Press **SET**.

Making a voice call using the EASY DIAL directory =

Before using this feature, program the desired names and telephone numbers into the directory (p. 20).

- 1 Rotate **EASY DIAL** until the desired name is displayed.

Example:

- 2 Press **MONITOR** / **DIGITAL SP-PHONE** or lift the handset.
 - The unit will start dialling automatically.

- 3 When the other party answers, talk into the microphone (KX-FP185/KX-FM189) or speak with the handset.

- 4 When finished talking, press **DIGITAL SP-PHONE** or replace the handset.

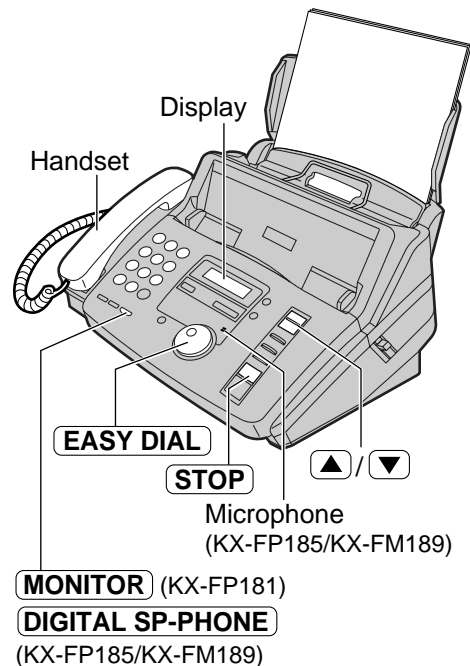

Helpful hint:

- You can confirm the stored items on the display (see below) or on the telephone number list (p. 85).

Note:

- If the desired name has not been stored, press **STOP** and dial the number manually.

To confirm the stored items on the display

1. Rotate **EASY DIAL** until the desired name is displayed.

Example:

2. Press **▲** or **▼**.

- To stop the operation, press **STOP**.
3. Lift the handset.
 - The unit will automatically dial the number.

To search for a name by initial

Example: If you want to search for the name "Lisa"

1. Rotate **EASY DIAL** until any name is displayed.

Example:

2. Press **5** repeatedly until any name with the initial "L" is displayed (see the character table on page 21).

3. Rotate **EASY DIAL** to the right until "Lisa" is displayed.

- To stop the operation, press **STOP**.

4. Lift the handset.
 - The unit will automatically dial the number.

Note:

- When you want to search for symbols (not letters or numbers), press ***** in step 2.

Caller ID (KX-FP185/KX-FM189 only)

Caller ID service from your phone company

This unit is compatible with a Caller ID service offered by your local telephone company. To use this feature, you must subscribe to a Caller ID service.

Important:

- This unit is designed in accordance with the “FSK based subscriber line protocol” under the ETS (European Telecommunication Standard) and only supports the basic CLIP (Calling Line Identification Presentation) features.
- This unit will only display the caller’s telephone number and name.
- This unit will not support future additional telephone services.
- This unit cannot support services based on the “DTMF based subscriber line protocol”.
- Depending on the service of the local telephone company, the date/time of the call or caller’s name may not be displayed.

Set the following ring count settings to 2 or more rings beforehand.

- FAX ring count and TAD ring count (feature #06 on page 65)
- TEL/FAX ring count (feature #78 on page 71)

How Caller ID is displayed

The calling party’s telephone number or name will be displayed after the first ring. You then have the option of whether or not to answer the call depending on the caller.

Example:

The unit will automatically store the caller’s information (telephone number, name and the time of the call). You can view the caller’s information (see next page) and print the caller ID list (p. 26).

Note:

- If the unit is connected to a PBX (Private Branch Exchange) system, you may not receive the caller’s information. Consult your PBX supplier.
- If the unit cannot receive caller information, the unit will show the following.

Display: <input data-bbox="281 1199 551 1238" type="text" value="OUT OF AREA"/>	The caller dialed from an area which does not provide a Caller ID service.
<input data-bbox="281 1263 551 1302" type="text" value="PRIVATE CALLER"/>	The caller requested not to send their information.
<input data-bbox="281 1327 551 1365" type="text" value="LONG DISTANCE"/>	The caller made a long distance call.

Caller ID (KX-FP185/KX-FM189 only)

Viewing caller information on the display

Once a call is received, the caller's information will be stored in the unit as a new call. After viewing, it will be stored as an old call.

- 1 Press **CALLER ID SEARCH**.
Example (2 new calls are received):

Display: 2 NEW CALLS
↕
USE EASY DIAL

- 2 Rotate **EASY DIAL** to the right (clockwise).
 - The display will show the most recent caller's number.

- 3 Press **STOP** to stop viewing.

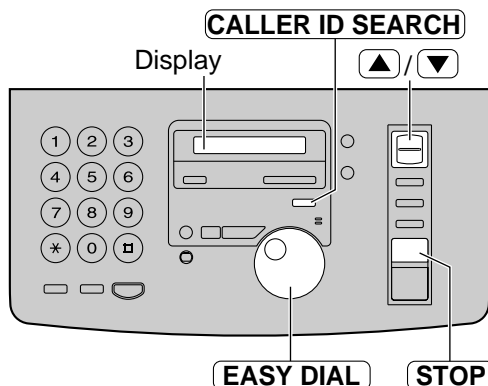

Note:

- If you want to know the date/time of the call and the caller's name, press **▲** or **▼** repeatedly while the display shows the number.

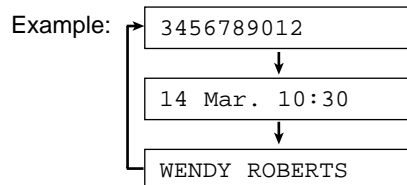

To search for caller information

- If you rotate **EASY DIAL** to the left, the display will show from the reviewed calls.
- If the unit could not receive name, the unit will show:

NO NAME RCVD

- After the last new call has been displayed, the unit will show:

END OF NEW CALL

- After all calls are displayed, the unit will show:

END

- If no calls have been received, the unit will show:

NO CALLER DATA

Confirming caller information using the Caller ID list

The unit will store caller information of up to 30 calls (Caller ID list).

- To print the Caller ID list manually, see page 85.
- This list will be printed out automatically after every 30 new calls.

This feature is set to "ON" as a default with feature #26 (p. 67). If you select "OFF", the unit will not print the list automatically but will store the records of received calls.

Caller ID (KX-FP185/KX-FM189 only)

Sample of a Caller ID list

CALLER ID LIST				
14 Mar. 2000 10:37				
[NEW]				
NO.	NAME	TELEPHONE NUMBER	TIME OF CALL	ANSWER
01	WENDY ROBERTS	3456789012	14 Mar. 10:30	FAX
02	ALLAN STONE	4567890123	13 Mar. 08:35	TAD
[OLD]				
NO.	NAME	TELEPHONE NUMBER	TIME OF CALL	ANSWER
01	MIKE TIMAR	9876543210	11 Mar. 09:35	TEL

NEW: Shows a call you have not yet viewed.
OLD: Shows a call you have already viewed.

FAX: Facsimile reception
TAD: Telephone answering device responded.
TEL: Telephone call received.
PC: Received by the PC (KX-FM189 only)
(blank): Not answered.

Note:

- When the total number of calls reaches 30 and a new call is received, the oldest data will automatically be erased.

Calling back using caller information

You can easily call back a caller using the stored caller information.

Important:

- This feature is not available in the following cases.
 - The telephone number includes data other than numbers (ie., * or #).
 - The caller's information does not include a telephone number.

1 Press **CALLER ID SEARCH**.

Example:

Display:

2 Rotate **EASY DIAL** until the desired telephone number (or name) is displayed.

Example:

- To confirm the name, press **▲** or **▼** repeatedly.

3 Press **DIGITAL SP-PHONE** or lift the handset.

- The unit will start dialling automatically.
- To send a fax – insert the document FACE DOWN and press **FAX START**. See pages 30 and 31 for details.



Storing caller information in the EASY DIAL directory

You can store caller information (telephone number and name) in the EASY DIAL directory.

Important:

- This feature is not available in the following cases.
 - The telephone number includes data other than numbers (ie., * or #).
 - The caller's information does not include a telephone number.

1 Press **CALLER ID SEARCH**.

Example:

↑

Display:

2 Rotate **EASY DIAL** until the number you want to store is displayed.

Example:

3 Press **DIRECTORY PROGRAM**.

- Edit the name by following the instructions on page 21.
- If the directory is full, a number and name cannot be stored. Erase unnecessary stations in EASY DIAL directory (p. 22).

4 Press **SET**.

Example:

5 Press **SET**.

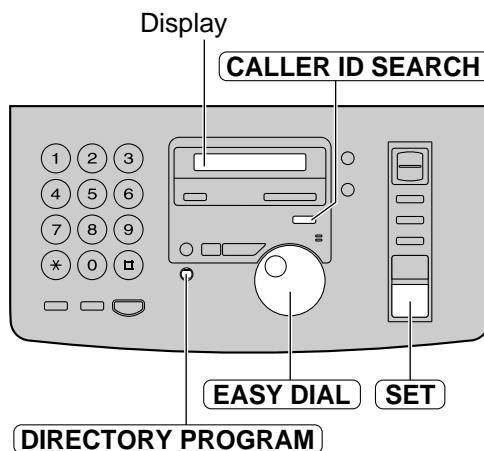

Note:

- You can confirm the stored items on the display (p. 23) or on the telephone number list (p. 85).
- You can only store a name up to 10 characters long.
- To edit items stored in the EASY DIAL directory, see page 22.

Caller ID (KX-FP185/KX-FM189 only)

Erasing caller information

Erasing specific caller information

- 1** Press **CALLER ID SEARCH**.

Example: 2 NEW CALLS



Display: USE EASY DIAL

- 2** Rotate **EASY DIAL** until the desired number is displayed.

Example: 3453809

- 3** Press **ERASE**.

- The caller's information will be erased.

DELETED



Example: 4561032238

- To erase other items, repeat steps 2 and 3.

- 4** Press **STOP** to exit the program.

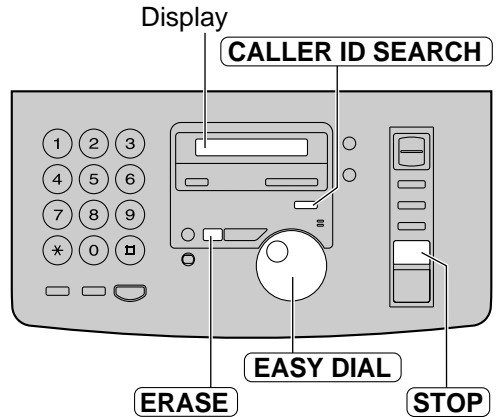

Erasing all stored caller information

- 1** Press **MENU** three times.

Display: 3.CALLER SET UP

- 2** Press **SET**.

CALL LIST ERASE

- 3** Press **SET**.

ERASE ALL OK?

- To cancel erasing, press **STOP**, then **MENU**.

- 4** Press **SET**.

ERASE COMPLETED

- 5** Press **STOP** to exit the program.

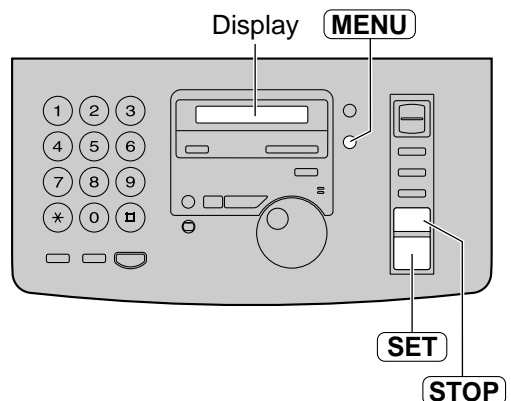

Talking to the other party after fax transmission or reception

You can talk to the other party after a fax message is completed. This will save the added expense and time of making another call.

This feature only works when the other party's fax machine is equipped with a voice contact feature.

Initiating voice contact

1 Press **MONITOR** / **DIGITAL SP-PHONE** while transmitting or receiving documents.

Display: VOICE STANDBY

- Your unit will call the other party with a distinctive ring.
- When the other party answers, your unit will emit a distinctive ring.

2 Press **DIGITAL SP-PHONE** (KX-FP185/KX-FM189) or lift the handset to start talking.

Note:

- If you initiate voice contact during transmission, the unit will call you with a distinctive ring after all of the documents have been transmitted.
- If you initiate voice contact during reception, the unit will call you with a distinctive ring after the current page of the document is received.

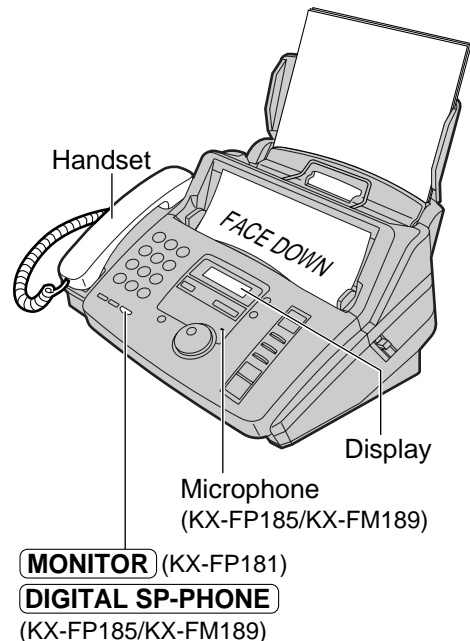

Receiving a request for voice contact

1 If the other party initiates voice contact, your unit will sound a distinctive ring and the following will be displayed.

Display: PLEASE PICK UP

2 Press **DIGITAL SP-PHONE** (KX-FP185/KX-FM189) or lift the handset within 10 seconds of the distinctive ring to start talking.

Note:

- If you do not answer within 10 seconds of the distinctive ring;
 - If in the FAX ONLY, TEL or TEL/FAX mode, the line will be disconnected.
 - If in the TAD/FAX mode, your unit will play a greeting message and record an incoming voice message (KX-FP185/KX-FM189 only).

Sending Faxes

Sending a fax manually/using the EASY DIAL directory =

- 1 Adjust the width of the document guides to the size of the document.
- 2 Insert the document (up to 10 pages) **FACE DOWN** until a single beep is heard and the unit grabs the document.

Display:

- 3 If necessary, press **RESOLUTION** repeatedly to select the desired setting (see below).

Manually

- 4 Lift the handset or press **MONITOR** / **DIGITAL SP-PHONE**.

- 5 Dial the fax number.

Example:

- 6 **When a fax tone is heard:**
Press **FAX START**, and replace the handset if using it.
OR

When the other party answers your call:
Lift the handset if using the monitor and ask them to press their start button. When a fax tone is heard, press **FAX START** and replace the handset.

Using the EASY DIAL directory

- 4 Rotate **EASY DIAL** until the desired name is displayed.

Example:

- To confirm the number, press **▲** or **▼**.
- For further details about using the EASY DIAL, see page 23.

- 5 Press **FAX START**.

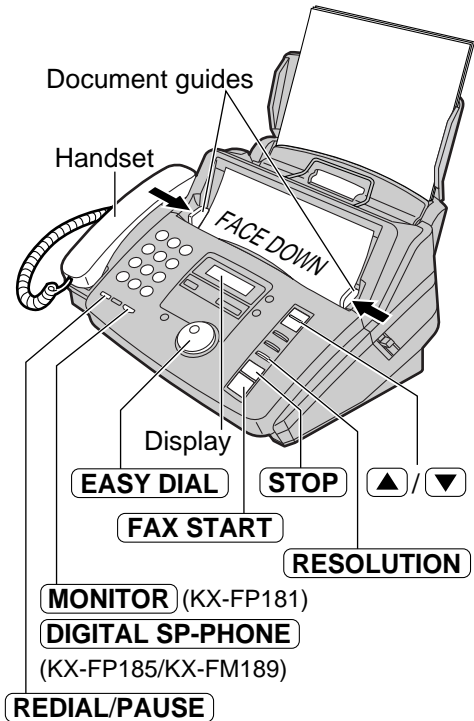

To select the resolution

Select the desired resolution according to the type of document.

STANDARD: For printed or typewritten originals with normal-sized characters.

FINE: For originals with small printing.

SUPER FINE: For originals with minute printing.

HALF TONE: For originals containing photographs, shaded drawings, etc.

- Using the "FINE", "SUPER FINE" or "HALF TONE" setting will increase the transmission time.
- If the resolution setting is changed during feeding, it will be effective from the next sheet.
- The "SUPER FINE" resolution only works with other compatible fax machines.

To transmit more than 10 pages at a time

Insert the first 10 pages of the document. Add the extra pages (up to 10) before the last page is fed into the unit.

To stop transmission

Press **STOP**.

To redial the last number

Press **REDIAL/PAUSE**.

- If the line is busy, the unit will automatically redial the number up to 5 times.
- During redial, the following will be displayed.

Display: WAITING REDIAL

- To cancel redialing, press **STOP**.

Fax auto redial for the EASY DIAL directory

If the line is busy or there is no answer when using the EASY DIAL directory, the unit will automatically redial the number up to 5 times.

- This feature is also available for delayed transmission (feature #25 on page 67).
- During redial, the following will be displayed.

Display: WAITING REDIAL

- To cancel redialing, press **STOP**.

Convenient way to send a fax

You can dial the fax number first before inserting the document. This is convenient if the other party's number is indicated on the document.

1. Enter the fax number.
 - The handset must be on the cradle.
2. Insert the document.
3. Press **FAX START**.

If your unit does not send a fax using the EASY DIAL directory

- Confirm the stored items on the display (p. 23) or on the telephone number list (p. 85).
- Check that the number dialled is answered by the other party's machine.
 1. Rotate **EASY DIAL** until the desired name is displayed.
 2. Lift the handset.
- The connecting tone will be heard during dialling to tell you the status of the other party's machine (feature #76 on page 71).

Documents you can send

Minimum size

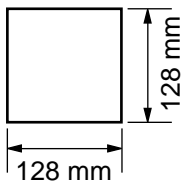

Maximum size

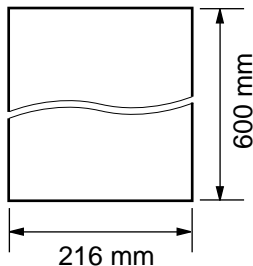

Effective scanning area

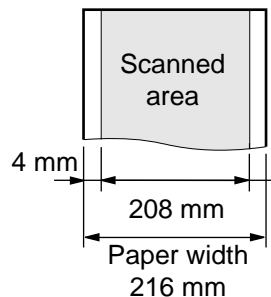

Document weight

Single sheet:
45 g/m² to 90 g/m²
Multiple sheets:
60 g/m² to 80 g/m²

Note:

- Remove clips, staples or other similar fastening objects.
- Check that ink, paste or correction fluid has dried.
- Do not send the following types of documents. Use copies for fax transmission.
 - Chemically treated paper such as carbon or carbonless duplicating paper
 - Electrostatically charged paper
 - Heavily curled, creased or torn paper
 - Paper with a coated surface
 - Paper with a faint image
 - Paper with printing on the opposite side that can be seen through the front (e.g. newspaper)

Sending Faxes

Reports for confirmation

To confirm the communication results, the following reports are available.

Sending report

This report will provide you with a printed record of transmission results. To change the setting, see feature #04 on page 65.

Sample of a sending report

SENDING REPORT									
20 Jan. 2000 09:19									
YOUR LOGO :									
YOUR FAX NO. :									
NO.	OTHER FACSIMILE	START TIME	USAGE TIME	MODE	PAGES	RESULT	*CODE		
01	2345678	20 Jan. 09:18	06'51	SND	10(02,04,05)	COMMUNICATION ERROR	43		

Communication message (p. 72) Error code

Journal report

The unit stores the 30 most recent fax communication results. When a new communication occurs, the oldest communication result will be erased.

—To print manually, see page 85.

—To print automatically after every 30 new fax communications, activate feature #22 (p. 67).

Sample of a journal report

JOURNAL									
25 Jan. 2000 11:22									
YOUR LOGO :									
YOUR FAX NO. :									
NO.	OTHER FACSIMILE	START TIME	USAGE TIME	MODE	PAGES	RESULT	*CODE		
01	3332222	21 Jan. 07:14	00'45	SND	01	OK			
02	9998765	21 Jan. 08:17	00'58	RCV	02	OK			
03	2345678	21 Jan. 09:18	00'48	RCV	01	OK			
04	5555666	25 Jan. 11:22	06'45	SND	10(02,04,05)	COMMUNICATION ERROR	43		
				SND	05	OK			
						OK			

Communication message (p. 72) Error code

Sending a fax with the voice guide

(KX-FP185/KX-FM189 only)

1 Press **HELP** twice.

Display: 1 .SEND GUIDE

2 Press **SET** .

Voice guide:

To transmit, insert the document face down until you hear the beep.

3 Insert the document FACE DOWN until a single beep is heard and the unit grabs the document.

Press the speaker phone button, then dial the phone number. When the fax tone is heard, press the start button.

4 Press **DIGITAL SP-PHONE** and dial the fax number.

- You can also use the handset.

5 When a fax tone is heard, press **FAX START** .

Start transmission.

Sending from memory

The unit is able to scan documents, store them in memory, and then transmit them from memory. The memory capacity is approx. 25 pages based on the ITU-T No. 1 Test Chart in standard resolution (p. 86).

1 Insert the document FACE DOWN.
• If necessary, press **RESOLUTION** repeatedly to select the desired setting (p. 30).

2 Enter the fax number using the dial keypad or **EASY DIAL** .

3 Press **QUICK SCAN** .
• The document will be fed into the unit and scanned into memory. After storing all of the pages, the unit will transmit the document.
• The amount of memory used will be shown as a percentage on the display.

Display: PAGES=01 05

Amount of memory used (%)

- The stored document will be automatically erased after transmission.

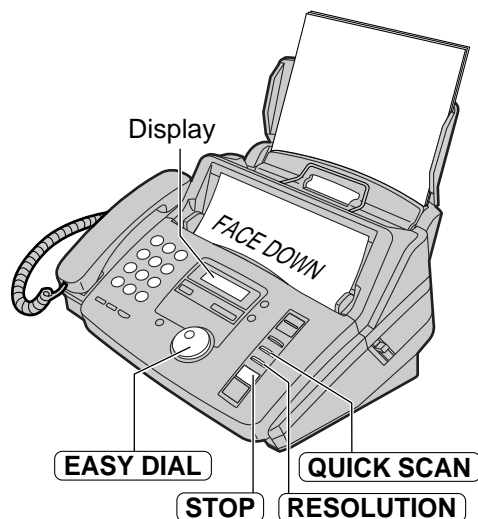

Note:

- If you select the "FINE", "SUPER FINE" or "HALF TONE" resolution, the number of pages that the unit can transmit will decrease.
- If the stored pages exceed the memory capacity, the transmission will be cancelled.

To cancel the memory transmission

Press **STOP** while or after scanning the document.

Sending Faxes

One time broadcast transmission

This feature is useful for sending the same document to selected parties whose fax numbers are stored in the EASY DIAL directory. If you only wish to send a document once, select the parties for each transmission.

Before programming, make sure that the desired stations have been stored in the EASY DIAL directory (p. 20).

- 1** Insert the document **FACE DOWN**.
 - If necessary, press **RESOLUTION** repeatedly to select the desired setting (p. 30).
- 2** Rotate **EASY DIAL** until the following is displayed.
Display: <ONE TIME BROAD>
- 3** Press **SET**.
DIR= [000]
- 4** Rotate **EASY DIAL** until the desired name is displayed.
Example: Bill [000]
- 5** Press **SET**.
DIR=Bill [001]
 - To program other stations, repeat steps 4 and 5 (up to 20 stations).
- 6** Press **FAX START** after programming all of the desired stations.
 - The document will be fed into the unit and scanned into memory. The unit will then transmit the data to each station, calling each number sequentially.
 - After transmission, the stored document will be erased automatically, and the unit will automatically print a broadcast sending report (p. 37).

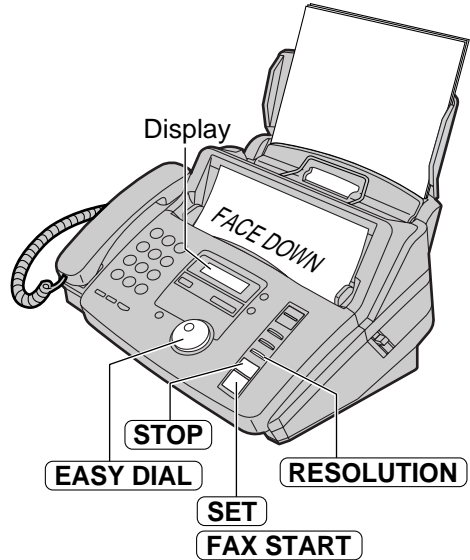

Note:

- If you select the "FINE", "SUPER FINE" or "HALF TONE" resolution, the number of pages that the unit can transmit will decrease.
- If one of the stations is busy or does not answer, the station will be skipped. All skipped stations will be redialed up to 5 times after all of the other stations have been called.

To cancel the broadcast setting

1. Press **STOP** while the unit displays the following message.

Display: BROADCASTING

- The display will show the following.

SEND CANCELLED?
↑
YES:SET/NO:STOP

2. Press **SET**.

Broadcast transmission to pre-programmed parties

This feature is useful for sending the same document often to selected parties whose fax numbers are stored in the EASY DIAL directory. First program the parties (see below) then see page 37 for transmission.

Before programming, make sure that the desired stations have been stored in the EASY DIAL directory (p. 20).

Programming the stations in the broadcast memory

1 Press **DIRECTORY PROGRAM** twice.

Display: BROADCAST
↓
PRESS SET

2 Press **SET**.

DIR= [000]

3 Rotate **EASY DIAL** until the desired name is displayed.

Example: John [000]

4 Press **SET**.

DIR=John [001]

- To program other stations, repeat steps 3 and 4 (up to 20 stations).

5 Press **SET** after programming all of the desired stations.

REGISTERED
↓
USE EASYDIAL OR
↓
PRESS DIR.PROG.

6 Press **STOP** to exit the program.

Note:

- If you enter the wrong station, press **STOP** after step 4 to erase the station.
- Confirm the stored numbers by printing a broadcast programming list (p. 85).

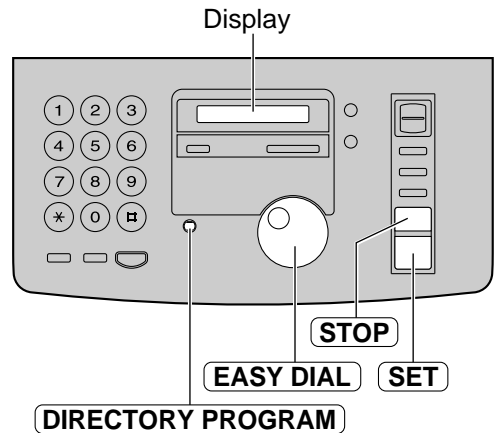

Sending Faxes

Adding a new station in the broadcast memory

- 1 Rotate **EASY DIAL** until the following is displayed.

Display:

- 2 Press **DIRECTORY PROGRAM** .

- 3 Press ***** to select "ADD".

- 4 Rotate **EASY DIAL** until the desired name is displayed.

Example:

- 5 Press **SET** .



Example:

- To add other stations, repeat steps 4 and 5 (up to 20 stations).

- 6 Press **DIRECTORY PROGRAM** to exit the program.

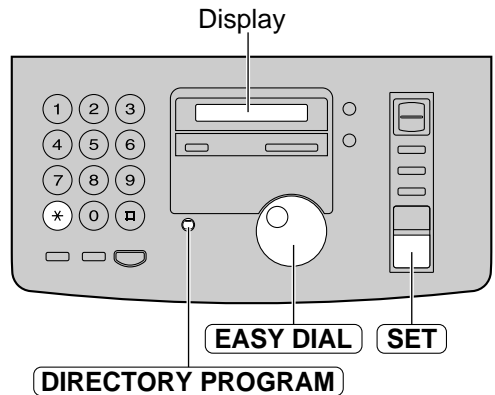

Erasing a stored station in the broadcast memory

- 1 Rotate **EASY DIAL** until the following is displayed.

Display:

- 2 Press **DIRECTORY PROGRAM** .

- 3 Press **#** to select "DELETE".

- 4 Rotate **EASY DIAL** until the desired name is displayed.

Example:

- To cancel erasing, press **STOP** .

- 5 Press **SET** .



- 6 Press **SET** .



Example:

- To delete other stations, repeat steps 4 to 6.

- 7 Press **DIRECTORY PROGRAM** to exit the program.

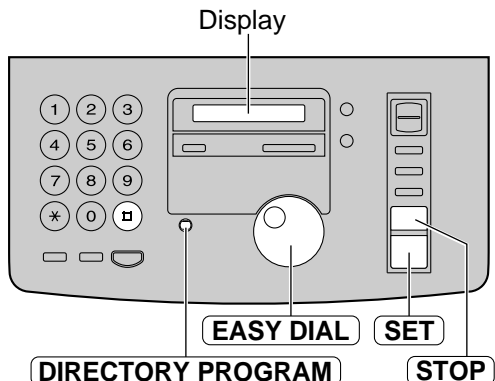

Sending to pre-programmed parties in the broadcast memory

The same document will be sent to the specific parties whose numbers are stored in broadcast memory.

The fax memory capacity for transmission is approx. 25 pages based on the ITU-T No. 1 Test Chart in standard resolution (p. 86).

- 1 Insert the document **FACE DOWN**.
 - If necessary, press **RESOLUTION** repeatedly to select the desired setting (p. 30).

- 2 Rotate **EASY DIAL** until the following is displayed.

Display:

- 3 Press **FAX START**.
 - The document will be fed into the unit and scanned into memory. The unit will then transmit the data to each station, calling each number sequentially.
 - After transmission, the stored document will be erased automatically, and the unit will automatically print a broadcast sending report (see below).

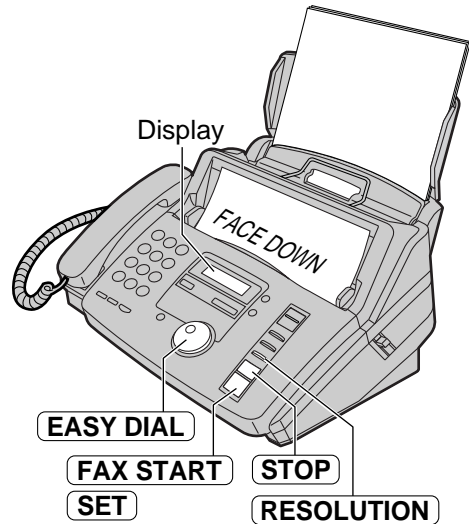

Note:

- If you select the "FINE", "SUPER FINE" or "HALF TONE" resolution, the number of pages that the unit can transmit will decrease.
- If one of the stations is busy or does not answer, the station will be skipped. All skipped stations will be redialled up to 5 times after all of the other stations have been called.

To cancel the broadcast setting

1. Press **STOP** while the unit displays the following message.

Display:

- The display will show the following.



2. Press **SET**.

Sample of a broadcast sending report

BROADCAST REPORT							10 Jan. 2000 09:36
							YOUR LOGO :
							YOUR FAX NO. :
NO.	OTHER FACSIMILE	START TIME	USAGE TIME	PAGES	RESULT		
01	Mike	10 Jan. 09:31	01'10	02	OK		
02	Peter	10 Jan. 09:33	01'08	02	OK		
03	Sam	10 Jan. 09:34	01'09	02	OK		
04	Kim	10 Jan. 09:35	01'10	02	OK		
TOTAL			004'37	008			

Receiving Faxes

Setting the unit to receive faxes

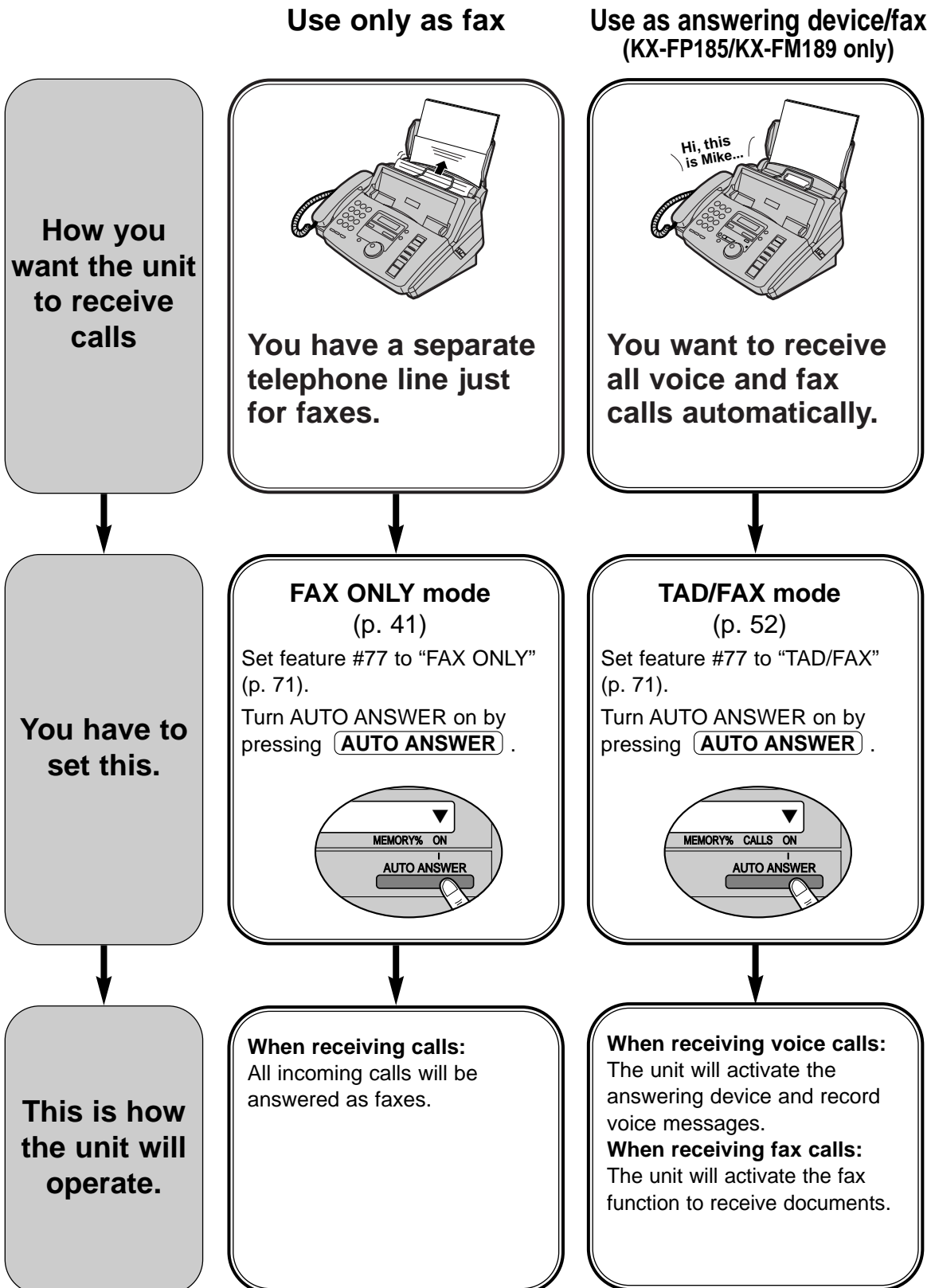

Use as telephone/ automatic fax

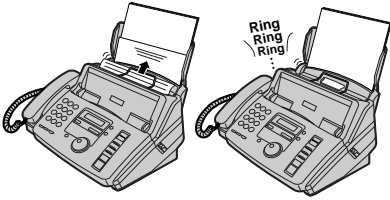

You want to answer the voice call yourself and receive fax calls without rings.

TEL/FAX mode (p. 44)

Set feature #77 to "TEL/FAX" (p. 71).

Turn AUTO ANSWER on by pressing **AUTO ANSWER**.

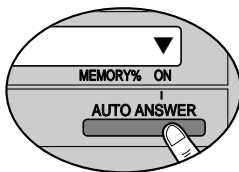

When receiving voice calls:
The unit will ring.

When receiving fax calls:
The unit will receive fax documents without ringing.

Mostly voice calls

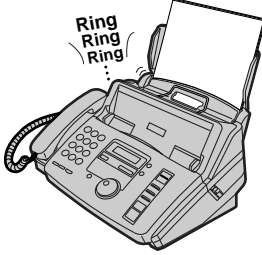

You plan to answer the calls yourself.

TEL mode (p. 40)

Turn AUTO ANSWER off by pressing **AUTO ANSWER**.

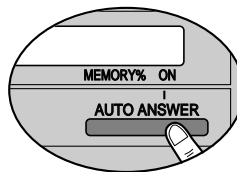

When receiving calls:
You have to answer all calls manually.
To receive a fax document, press **FAX START** for each fax call.

Other options

With answering machine (KX-FP181 only)

You can use the fax machine with an answering machine, see pages 42 and 43.

With PC

If you have a computer attached to the same telephone line, see page 43.

Remote fax activation

You can also receive a fax using an extension telephone. While hearing fax calling tone with an extension telephone, press *** 9** (pre-selected fax activation code) to receive a fax (p. 47).

Receiving Faxes

TEL mode (answering all calls manually)

Activating the TEL mode

If the arrow (▼) is shown on the right of the display, turn it off by pressing **AUTO ANSWER**.

Display: TEL MODE ON

Receiving a fax manually

1 When the unit rings, press **DIGITAL SP-PHONE** (KX-FP185/KX-FM189) or lift the handset to answer the call.

2 When:
— document reception is required,
— a fax calling tone (slow beep) is heard, or
— no sound is heard,
press **FAX START**.

CONNECTING.....

3 Replace the handset.
• The unit will start fax reception.

Note:

- Up to 30 sheets of printed paper can be held. Remove the printed paper before it exceeds 30 sheets.

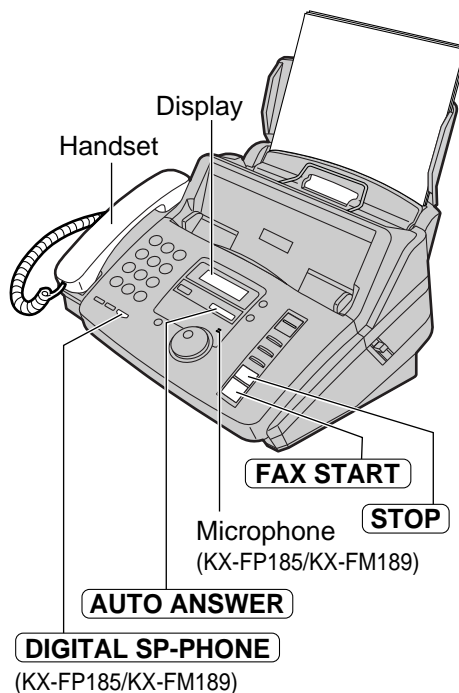

To stop receiving

Press **STOP**.

Friendly reception feature

When you answer a call and hear a fax calling tone (slow beep), the unit will automatically start fax reception.

- If this feature is not required, set feature #46 to "OFF" (p. 69).

Fax reception in memory

When a printing problem is detected, the unit will temporarily store the received document into memory.

While the document is in memory;

- the display will show an error message and the following message alternately.

Display: FAX IN MEMORY

- slow beeps will sound (memory reception alert). See feature #44 on page 69.

- Follow the instructions on pages 73 and 74 to solve the problem.
- For memory capacity, see page 86.

Receiving Faxes

Using the unit with an answering machine

(KX-FP181 only)

Setting up the fax machine and an answering machine

- 1 Connect the answering machine.

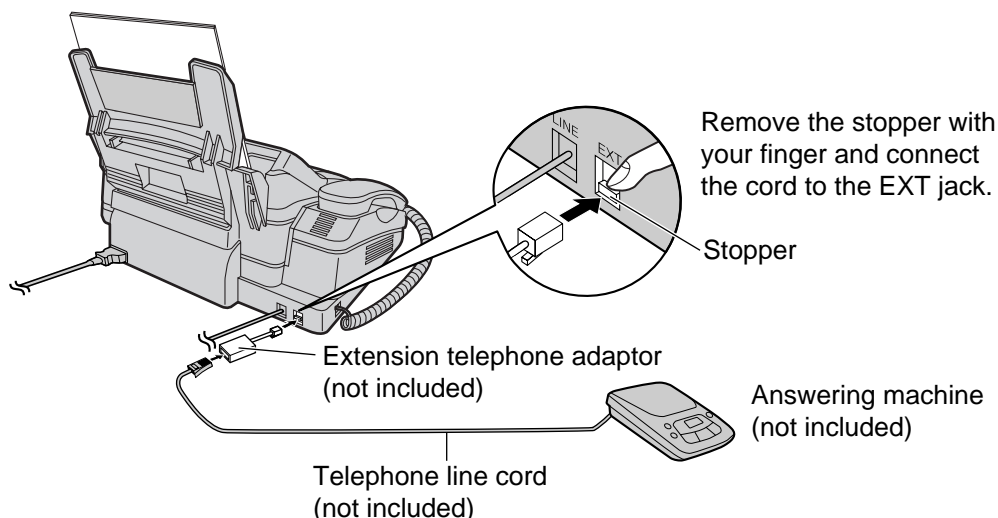

- 2 Set the number of rings on the answering machine to less than 4.
 - This will allow the answering machine to answer the call first.
- 3 Record a greeting message on the answering machine.

Example: *"This is (your name, business and/or telephone number). We are unable to answer the phone right now. To send a fax, start transmission. To leave a message, please speak after the beep. Thank you."*
- 4 Activate the answering machine.
- 5 Set the receive mode of the fax machine to the TEL mode (p. 40) or FAX ONLY mode (p. 41).
 - If you set to the FAX ONLY mode, **set the ring count in the FAX ONLY mode to more than 5 (feature #06 on page 65)**. Using the FAX ONLY mode will allow you to receive faxes if the answering machine is full.
- 6 Check the remote access code of the answering machine and program the same code into the remote operation ID of the fax machine. See feature #12 on page 66.

Note:

- We recommend you keep the greeting message around to 10 seconds long. If the greeting message is too long, some incoming fax calls may not be answered by the fax machine.
- Every time the fax machine receives a document, a silent pause or fax tone may be recorded on the answering machine.

How the fax machine and answering machine work

Receiving voice calls

The answering machine will record voice messages automatically.

Receiving fax calls

The fax machine will receive documents automatically when the machine detects a calling tone.

Receiving a voice message and fax document in one call

The answering machine will record the voice message first. The fax machine will then be activated by the caller's request and will receive the document.

Receiving a voice message and fax document in one call

The caller can leave a voice message and send a fax document during the same call. Inform the caller of the following procedure beforehand.

1. The caller calls your fax machine.
 - The answering machine will answer the call.
2. The caller can leave a message after the greeting message.
3. The caller presses ***9** (pre-selected fax activation code).
 - The fax machine will activate the fax function.
4. The caller presses the start button to send a document.

Note:

- The fax activation code can be changed in feature #41 (p. 68).
- If the wrong fax activation code is entered, the caller must wait at least 5 seconds to reenter the correct code.

To use with a computer

We recommend that you always connect the fax machine directly to the wall jack.

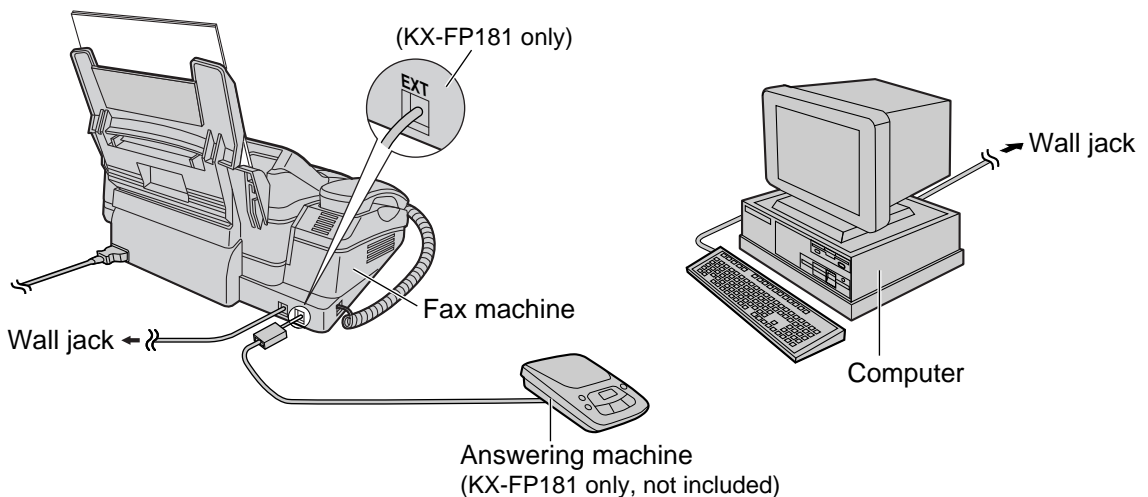

Note:

- Set the fax machine to the TEL mode.
- The device which has the shortest ring count will answer a call first.
- If you use your computer as an answering machine, connect the telephone line cord from the EXT jack to the computer (KX-FP181 only).

Receiving Faxes

TEL/FAX mode (receiving voice calls with rings and fax calls without rings when you are near the unit)

Use this mode when you are always near the fax machine, and want to receive faxes without ringing. When a call is received, the fax machine will work as follows. To set the TEL/FAX mode, see below.

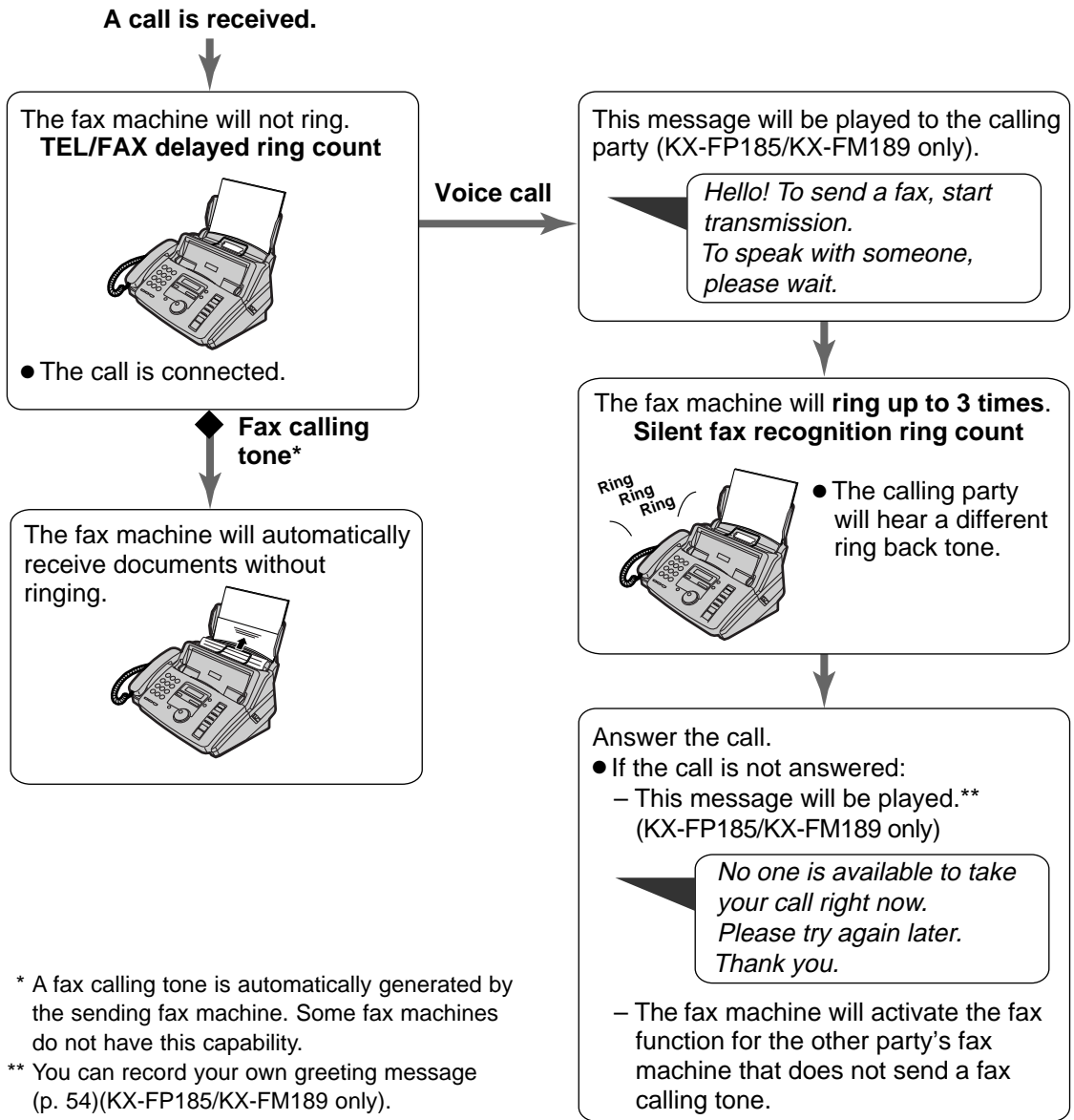

* A fax calling tone is automatically generated by the sending fax machine. Some fax machines do not have this capability.

** You can record your own greeting message (p. 54)(KX-FP185/KX-FM189 only).

Note:

- The fax machine will display the following when a call is received.

Display:

- The ringer should be on (p. 17).

To set the TEL/FAX mode

1. Set feature #77 to "TEL/FAX" (p. 71).
2. If the arrow (▼) is not shown on the right of the display, turn it on by pressing **AUTO ANSWER**.

Display:

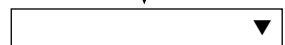

ON

When an extension telephone is connected

A call is received.

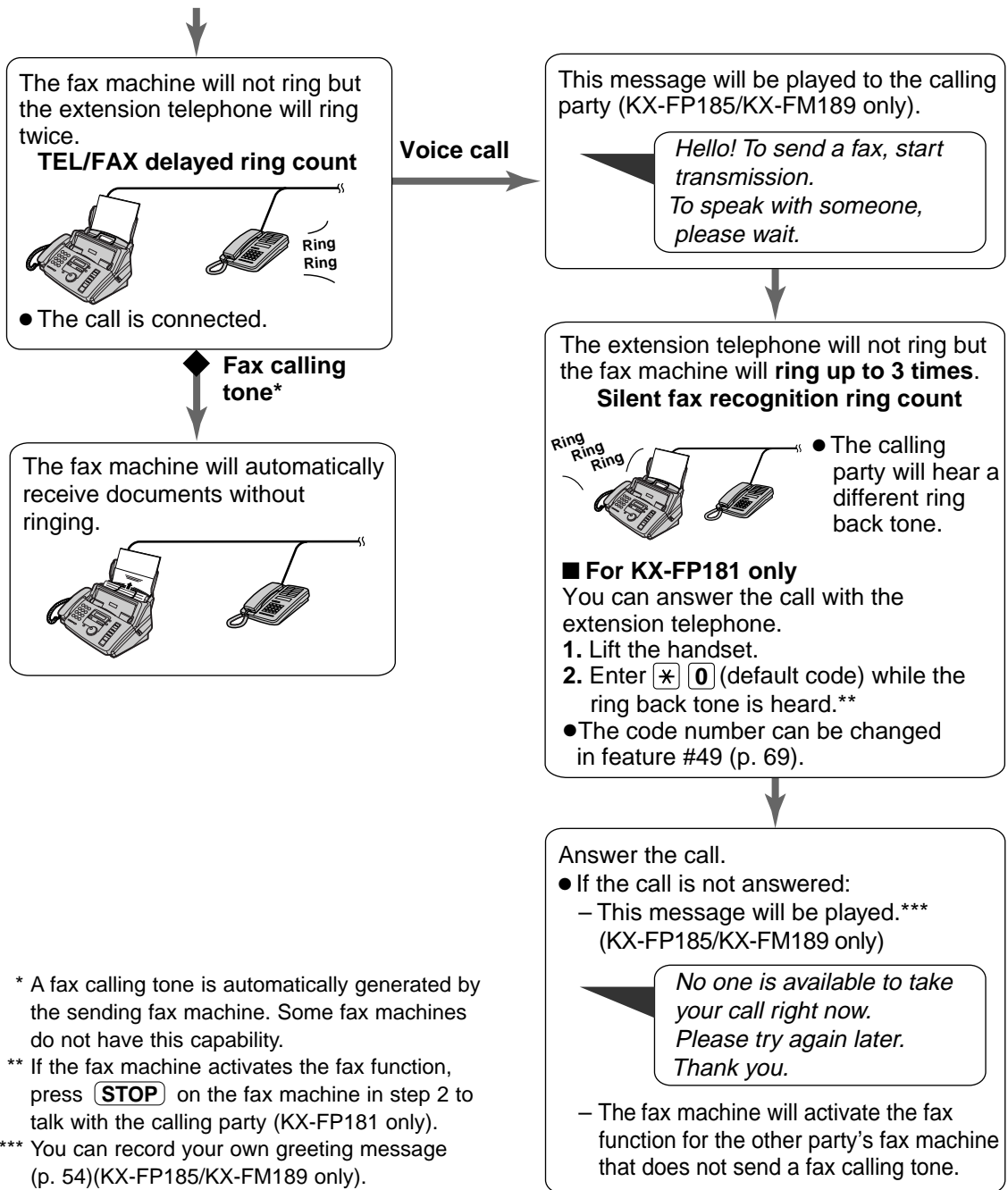

* A fax calling tone is automatically generated by the sending fax machine. Some fax machines do not have this capability.

** If the fax machine activates the fax function, press **STOP** on the fax machine in step 2 to talk with the calling party (KX-FP181 only).

*** You can record your own greeting message (p. 54)(KX-FP185/KX-FM189 only).

TEL/FAX delayed ring count

The number of rings generated before the fax machine answers depends on the setting of feature #78 on page 71. The fax machine will not generate an audible ring during this time.

Silent fax recognition ring count

The fax machine generates audible rings to indicate that it is receiving a voice call. The number of rings generated depends on the setting of feature #30 on page 67. This signal will not ring at an extension telephone.

Receiving Faxes



Turning the AUTO ANSWER mode on remotely

When you are not in, and the AUTO ANSWER mode of your unit is set to off (TEL mode), you can turn the AUTO ANSWER mode on from a remote location using a touch tone telephone.



AUTO ANSWER mode:

- FAX ONLY mode
- TEL/FAX mode
- TAD/FAX mode (KX-FP185/KX-FM189 only)



■ For KX-FP181

1. Call your unit and wait for 10 rings.
 - You will hear a beep signal.
2. — **To switch to the FAX ONLY mode:**
Press  within 8 seconds.
— **To switch to the TEL/FAX mode:**
Press  within 8 seconds.
3. Hang up the handset.

Note:

- Press  or  within 8 seconds after hearing the beep, otherwise the call will be interrupted and the unit will remain in the TEL mode.

■ For KX-FP185/KX-FM189

1. Call your unit and wait for 10 rings.
 - You will hear a beep signal.
2. Enter the remote operation ID (feature #11 on page 66) within 8 seconds.
 - You will hear a beep signal.
3. — **To switch to the FAX ONLY mode:**
Press  within 3 seconds.
— **To switch to the TEL/FAX mode:**
Press  within 3 seconds.
— **To switch to the TAD/FAX mode:**
Wait for 3 seconds, then the greeting message will be played.
4. Hang up the handset.

Note:

- Enter the remote operation ID within 8 seconds after hearing the beep, otherwise the call will be interrupted and the unit will remain in the TEL mode.

Extension telephone

If you use the fax machine with an extension telephone, you can receive fax documents using the extension telephone.

You do not have to press **FAX START** on the fax machine.

Important:

- Use a touch tone telephone as the extension telephone and enter the fax activation code **firmly**.

1 When the extension telephone rings, lift the handset of the extension telephone.

2 When:
— document reception is required,
— a fax calling tone (slow beep) is heard, or
— no sound is heard,
press *** 9** (pre-selected fax activation code) **firmly**.

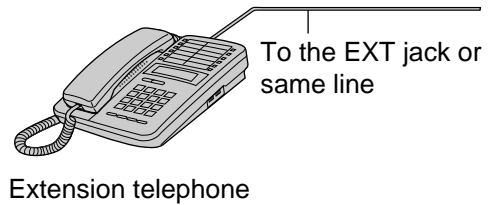

3 Hang up the handset.
• The fax machine will start reception.

Note:

- You can change the fax activation code in feature #41 (p. 68).

Receiving Faxes

Receive polling (retrieving a fax placed on another fax machine)

This feature allows you to retrieve a document from another compatible machine. Therefore you pay for the call.

Make sure that no documents are fed into your unit and that the other party's machine is ready for your call.

- 1** For **KX-FP181**
Press **MENU** three times.

Display: 3 . POLLING

- For **KX-FP185/KX-FM189**
Press **MENU** four times.

4 . POLLING

- 2** Press **SET** .

- 3** Dial the fax number.

Example: FAX=3331111

- 4** Press **SET** .

CONNECTING

- The unit will start reception.

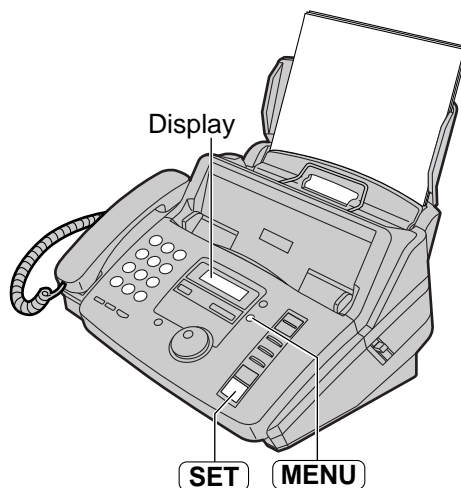

Pager call

This feature allows your unit to call your pager when your unit receives an incoming voice message (KX-FP185/KX-FM189 only) or a fax document.

1 Press **MENU** .
 Display: 1.SYSTEM SET UP

2 Press **▣** , then **7 0** .
 For KX-FP181: FAX PAGER CALL

For KX-FP185/
 KX-FM189: PAGER CALL

3 Press **SET** .
 MODE=OFF

4 Rotate **EASY DIAL** to select "ON".
 MODE=ON

• If this feature is not required, select "OFF".

5 Press **SET** .
 NO. =

6 Enter your pager number.
 • You can enter a total of 46 digits and/or pauses.

Example:
 1 202 555 1234PP12345678PP5555#
 Your pager number Pauses Your pager access code, if required. Message you want displayed on your pager.

7 Press **SET** .
 • The unit will dial the stored number.
 PAGER TEST

8 Check that your pager receives a pager test call.

9 Press **MONITOR** / **DIGITAL SP-PHONE** .

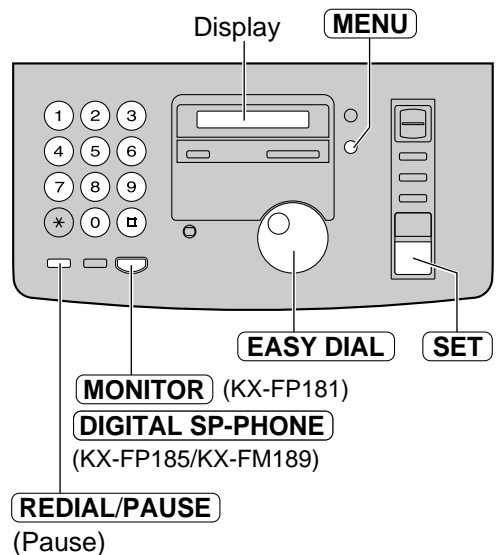

When your pager receives a pager call

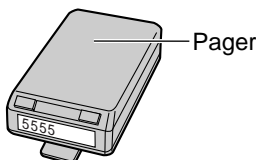

Your pager will display the message you entered in step 6 above.
 (For example: 5555)

Copying

Making a copy

The unit can make single or multiple copies (up to 50). Any transmittable document (p. 31) can be copied.

1 Adjust the width of the document guides to the size of the document.

2 Insert the document (up to 10 pages) **FACE DOWN** until a single beep is heard and the unit grabs the document.

Display:

- Make sure the handset is on the cradle.
- If necessary, press **RESOLUTION** repeatedly to select the desired setting (p. 30).

3 Press **COPY START**.

- If necessary, enter the number of copies (up to 50).
- If necessary, choose an enlargement/reduction rate by pressing **COPY ZOOM**. See next page.
- If you want to print collated (sorted) copies, press **COLLATE** until the following is displayed.

4 Press **COPY START**.

- The unit will start printing.
- If you want to remove the copy document for other uses, press **QUICK SCAN** instead of **COPY START**. The unit will feed the document and scan it into memory, then start printing.

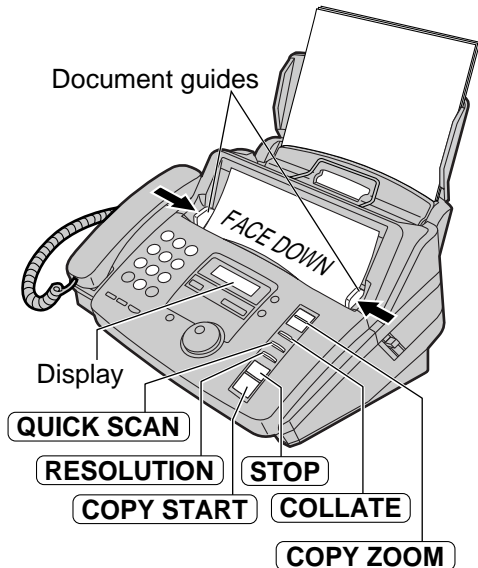

Note:

- If a resolution is not selected, "FINE" resolution will automatically be selected.
- You can make or receive a voice call while making copies.
- After copying, the enlargement/reduction rate setting will return to "100%".

To stop copying

Press **STOP**.

Printing collated (sorted) copies

Example: Making two copies of a 4-page original document

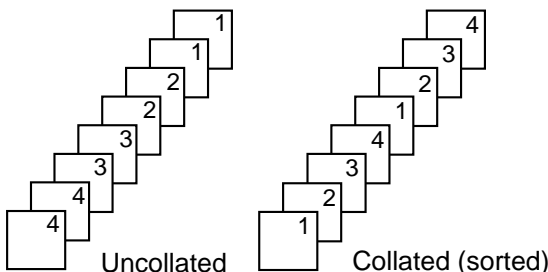

Note:

- If you turn the collating feature on, the unit will store the documents into memory. If memory becomes full while storing, the unit will only print out the stored pages.
- After copying, the collating feature will turn off automatically.

To enlarge a document

Select "200%" or "150%" by pressing **COPY ZOOM** (+). The unit will only enlarge the centre part of the document and print it on two pages.

Example of a 200% enlarged copy

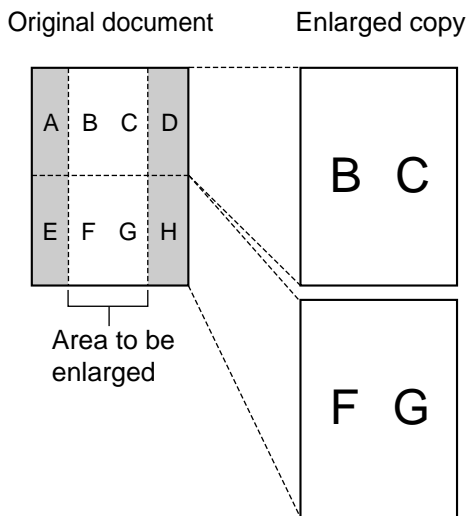

Example of a 150% enlarged copy

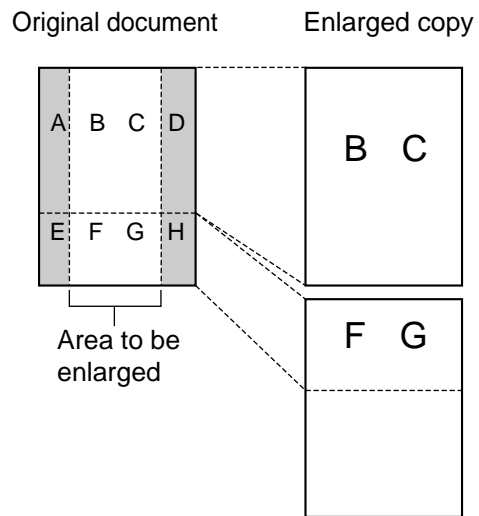

To reduce a document

The unit can reduce the original document.

Select the desired setting by pressing **COPY ZOOM** (-).

Recommended reduction rates:

Setting	Size of recording paper	Size of original document
100% (default)	A4	A4, Letter
92%	A4	A4
86%	A4	A4
72%	A4	Legal

A4 = 210 mm x 297 mm

Letter = 216 mm x 279 mm

Legal = 216 mm x 356 mm

Note:

- If the appropriate reduction rate is not programmed, the document may be divided and the top of the second sheet will be deleted.
- If the image at the bottom of the document is not copied when you copy a document as long as the recording paper, try 92% or 86%.

Setup (KX-FP185/KX-FM189 only)

TAD/FAX mode (using the built-in answering device and receiving voice and fax calls automatically)

When the TAD/FAX mode is set, the unit will work as a fax machine and/or answering device. If a fax call is detected, the unit will automatically receive the fax. If a voice call is detected, the answering device will play a greeting message and the caller can leave a voice message.

- You can use either the pre-recorded greeting messages (see next page) or your own greeting message (p. 54).

Setting up the voice and fax message reception

1 Set feature #77 to "TAD/FAX" (p. 71).

2 If the arrow (▼) is not shown on the right of the display, turn it on by pressing

AUTO ANSWER.

Display: TAD/FAX MODE

- The unit will play the greeting message.
- The remaining time for recording incoming messages will be displayed.

Example: TIME = 10m13s



▼

ON

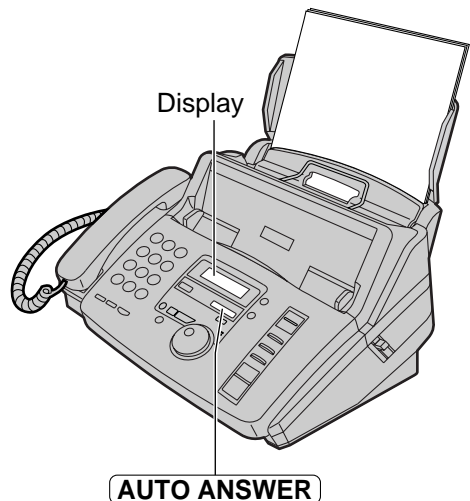

Note:

- The incoming message recording time can be changed (feature #10 on page 65).
- For voice memory capacity for incoming messages, see page 86.
- When the remaining time is low, erase unnecessary messages (p. 57).
- While an incoming call is being recorded, you can monitor it through the speaker. If this feature is not required, set to "OFF" (feature #67 on page 70).

Ring count in the TAD/FAX mode

The number of rings before a call is answered can be changed on feature #06 (p. 65).

You can choose from 1, 2, 3, 4, TOLL SAVER and RINGER OFF.

TOLL SAVER: When you call the unit from a remote location, the number of rings will tell you if there are any new voice messages. If the unit answers on the second ring, there is at least one new recorded message. If the unit answers on the fourth ring, there are no new recorded messages. To save the toll charges for the call, hang up immediately when you hear the third ring. The third ring indicates that there are no new recorded messages.

RINGER OFF: The unit will answer without ringing.

- If you subscribe to a Caller ID service, set to 2 or more rings.

Greeting (KX-FP185/KX-FM189 only)

Pre-recorded greeting messages

The unit has pre-recorded greeting messages. Depending on the situation, one of the following messages will be played to the caller. For your own greeting message, see page 54.

■ When the unit is ready to receive voice and fax calls:

*Hello! We are unable to answer right now.
To send a fax, please start transmission.
To leave a voice message, please speak
after the beep.
Thank you.*

■ When voice or fax memory is full:

Display: MESSAGE FULL

*Hello! We are unable to answer right now.
To send a fax, please start transmission.
To leave a voice message, please try again
later.
Thank you.*

FAX MEMORY FULL

*Hello! We are unable to answer right now.
To send a fax, please try again later.
To leave a voice message, please speak
after the beep.
Thank you.*

MESSAGE FULL

and

FAX MEMORY FULL

*Hello! We are unable to answer right now.
Please try again later.
Thank you.*

Note:

- To clear the problem, see pages 73 and 74.

Greeting (KX-FP185/KX-FM189 only)

Recording your own greeting messages

You can record your own greeting messages for the TAD/FAX and TEL/FAX modes. When receiving a call, your own greeting message will be played instead of the pre-recorded message. The recording time will be limited to 16 seconds. We recommend you record your message within 12 seconds to make it easier to receive faxes.

Suggested messages

TAD/FAX greeting message	<i>"This is (your name, business and/or telephone number). We are unable to answer right now. To send a fax, start transmission. To leave a message, speak after the beep. Thank you."</i>
TEL/FAX greeting message	<i>"This is (your name, business and/or telephone number). We are unable to answer right now. Please try again later. Thank you."</i>

1 Select the desired mode (TAD/FAX or TEL/FAX) where you want to record a greeting message (feature #77 on page 71).

2 Press **RECORD** twice.

- The display will show the following according to your selection in step 1.

TAD/FAX mode: 2.TAD GREETING

TEL/FAX mode: 2.T/F GREETING

↑↓

PRESS START

3 Press **START**.

- A long beep will sound.

4 Speak clearly about 20 cm away from the microphone.

- The display will show the remaining recording time.

TAD/FAX mode: TAD REC. 15s

TEL/FAX mode: T/F REC. 15s

5 When finished recording, press **STOP**.

- The unit will repeat your message. Adjust the volume using ▲ or ▼.

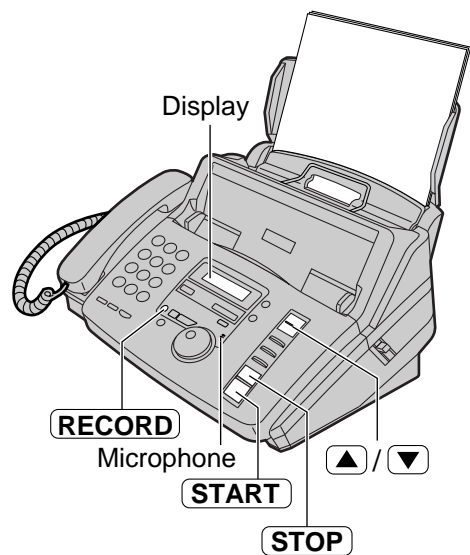

Note:

- If you make a mistake while recording, start again from step 2.
- You can choose 60-seconds for your own TAD/FAX greeting message (feature #54 on page 69).
 - If you change to 60-seconds, we recommend that you tell the caller in your own TAD/FAX greeting message to press *** 9** before starting fax transmission.
 - If you change to 16-seconds from 60-seconds, your own recorded TAD/FAX greeting message will be deleted and the pre-recorded message will be played.

Greeting (KX-FP185/KX-FM189 only)

Checking the greeting messages

1 Select the desired mode (TAD/FAX or TEL/FAX) where you want to listen to a greeting message (feature #77 on page 71).

2 If the arrow (▼) is not shown on the right of the display, turn it on by pressing **AUTO ANSWER**.

If the arrow (▼) is shown on the right of the display, turn it off once then on again.

TAD/FAX mode:

TEL/FAX mode:

- The unit will play the greeting message.

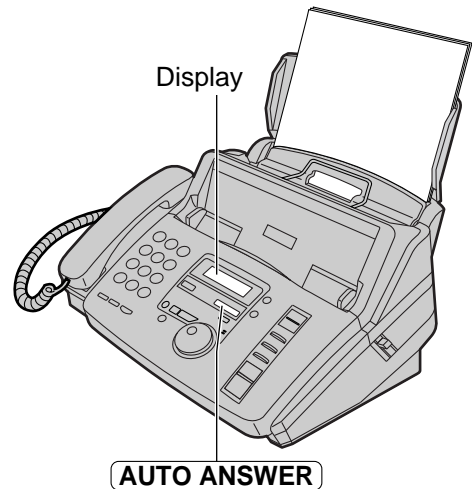

Erasing your own recorded greeting messages

1 Select the desired mode (TAD/FAX or TEL/FAX) where you want to erase the greeting message (feature #77 on page 71).

2 Press **ERASE** two times.

- The display will show the following according to your selection in step 1.

TAD/FAX mode:

TEL/FAX mode:

↑
↓

3 Press **START**.

↑
↓

- To cancel erasing, press **STOP**.

4 Press **SET**.

- When receiving a call, the pre-recorded greeting message will be played.

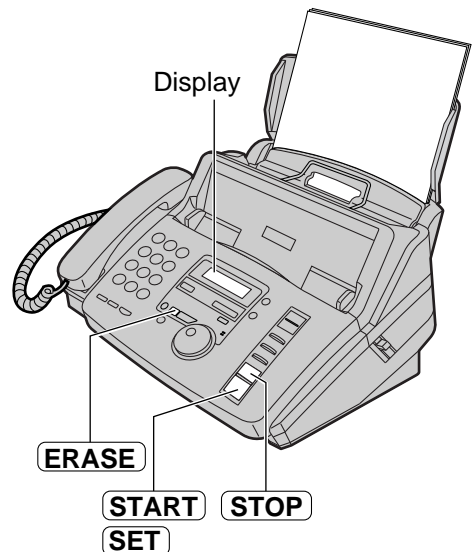

Incoming Messages (KX-FP185/KX-FM189 only)

Listening to recorded messages

When the unit has recorded new voice messages:

- the PLAY MESSAGES indicator will flash,
- the call counter will show the total number of recorded messages, and
- slow beeps will sound if the message alert feature is activated (feature #42 on page 68).

Press **PLAY MESSAGES**.

- Only the new recorded messages will be played.
- Adjust the speaker volume using **▲** or **▼**.
- After playing back all of the new messages, the PLAY MESSAGES indicator will stop flashing and just light up.
If you press **PLAY MESSAGES** at this time, all the recorded messages will be played.

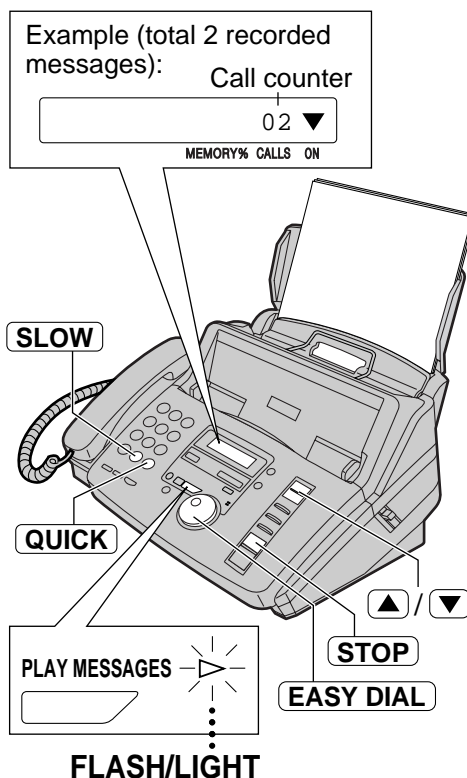

Repeating a message

Rotate **EASY DIAL** one click to the left while listening to the message.

- If you rotate **EASY DIAL** to the left within 5 seconds of the beginning of the message, the previous message will be played.
- To play back a specific message, rotate **EASY DIAL** to the left or right and search for the message you want to listen to.

Skipping a message

Rotate **EASY DIAL** one click to the right to play the next message.

Stopping playback

Press **STOP**.

- If you press **PLAY MESSAGES** within 1 minute, the unit will resume playing the rest of the messages.

Changing the playback speed

Press **QUICK** to play messages at one and a half times the original speed.

Press **SLOW** to play messages at half the original speed.

- To return to the original speed, press **QUICK** or **SLOW** again during quick or slow playback.

Voice time/day stamp

During playback, a synthesised voice will announce the time and day of the week that each message was recorded.

Incoming Messages (KX-FP185/KX-FM189 only)

Erasing recorded messages

Erase unnecessary messages to prevent memory from becoming full.

Erasing a specific message

- 1 Press **ERASE** while listening to the message you want to erase.

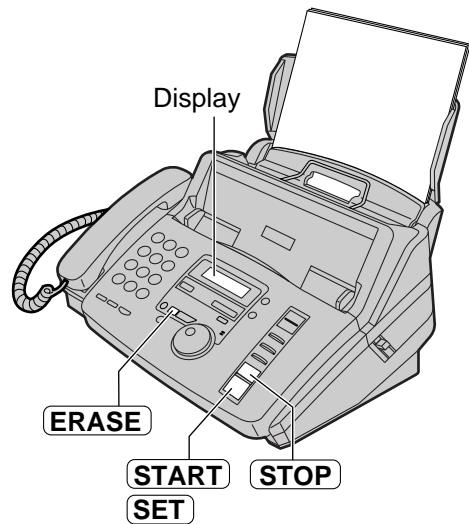
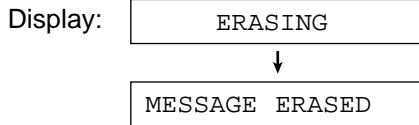

Erasing all the messages

Check that you have listened to all of the recorded messages.

- 1 Press **ERASE**.

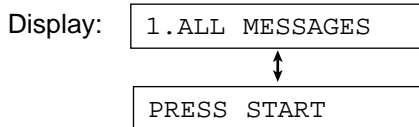

- 2 Press **START**.

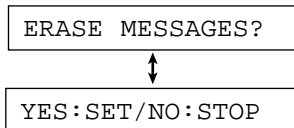

- To cancel erasing, press **STOP**.

- 3 Press **SET**.

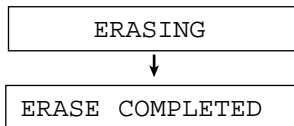

Note:

- Greeting messages can not be erased this way.

Recording (KX-FP185/KX-FM189 only)

Memo message --- --- (leaving a message for others or yourself)

To leave a private message for yourself or someone else, you can record a voice memo. This memo can be played back later, either directly or remotely.

1 Press **RECORD**.

Display: 1.MEMO MESSAGE



PRESS START

2 Press **START**.
• A long beep will sound.

MEMO RECORDING

3 Speak clearly about 20 cm away from the microphone.

4 When finished recording, press **STOP**.

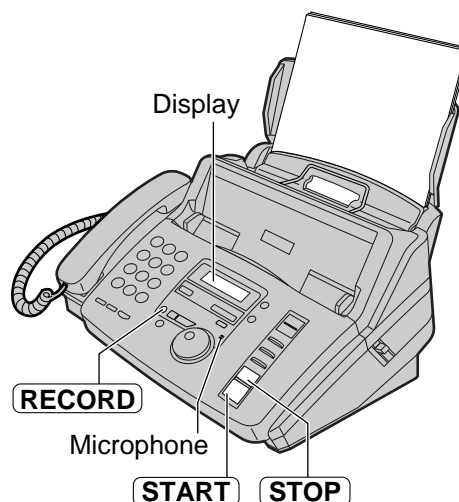

Telephone conversation --- ---

You can record a telephone conversation. This conversation can be played back later, either directly or remotely.

1 During a telephone conversation, press **RECORD**.

Display: 2WAY RECORDING

2 To stop recording, press **STOP** or replace the handset.

Note:

- There may be legal restrictions on recording two-way telephone conversations. Inform the other party that the conversation is being recorded.

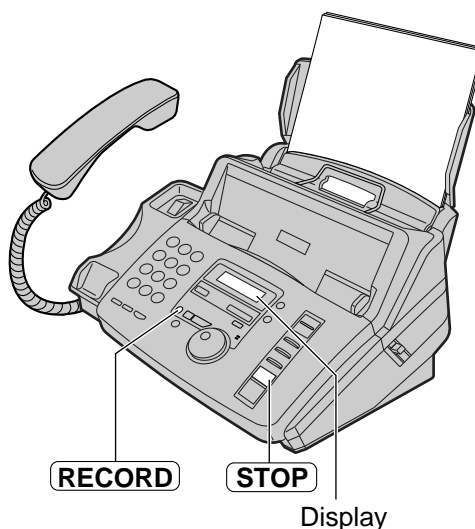

Remote Operation (KX-FP185/KX-FM189 only)

Operating from a remote location

The following operations can be performed from a remote location using a touch tone telephone. **Program the remote operation ID (feature #11 on page 66) and set the unit to the TAD/FAX mode before going out (p. 52).**

Dial key	Remote command	Page	Dial key	Remote command	Page
0	Skips the greeting message	61	9	Stops re-recording of a greeting message	61
1	Repeats a message	60	*4	Erases a specific message	61
2	Skips a message	60	*5	Erases all messages	61
4	New message playback	60	80	Changes to the TEL mode	61
5	All message playback	60	81	Turns ON message transfer	61
7	Re-records a greeting message	61	82	Turns OFF message transfer	61
8	Continues operation	See note	83	Turns ON pager call	61
			84	Turns OFF pager call	61

Note:

- During remote operation, the unit will stop and two beeps will be heard in the following conditions:
 - 2 minutes 40 seconds after your unit answered.
 - Every 2 minutes 40 seconds after pressing any command key.To listen to further messages, press **8** within 10 seconds after hearing the two beeps.

Remote operation card

Please cut out and carry this card for assistance when using the remote operation.

Answering Device Remote Operation	Notice of Remote Operation
<ol style="list-style-type: none">1. Call your unit.2. Enter the remote operation ID <input type="text"/> during the greeting message.<ul style="list-style-type: none">• The new messages will be played automatically.• If there are no new messages, wait for 4 seconds. All the messages will be played back.3. Press the remote command key(s) within 10 seconds (see the reverse side).	<ul style="list-style-type: none">• The remote operation is available only from a touch tone telephone when the unit is in the TAD/FAX mode.• When the unit is in the TEL mode, call your unit and wait for 10 rings. Enter the remote operation ID within 8 seconds and wait for 3 seconds. The unit will switch to the TAD/FAX mode.• When you press a key, press firmly.• To send a document, press *9. When a fax tone is heard, start transmission.

Fold here

Remote Operation (KX-FP185/KX-FM189 only)

Operation from a remote touch tone telephone

Listening to recorded messages

1 Call your unit.

2 Enter the remote operation ID during the TAD/FAX greeting playback.

When there are new recorded messages

The voice guide will tell you the number of new recorded messages and they will be played automatically.

Voice guide example:

3 new messages.

- **To repeat only the new messages:**

Press **4**.

- **To repeat the current message:**

Press **1**.

If you press **1** within 5 seconds of the beginning of a message, the previous message will be played.

- **To listen to all the messages:**

Press **5**.

- **To skip a message:**

Press **2**.

When there are no new recorded messages

No new messages.

Press **5** or wait for 4 seconds to listen to all the messages.

When voice memory is full

*Sorry, no more memory.
Please erase unnecessary messages.*

Erase some or all of the messages (see next page).

Key	Remote command
0	Skips the greeting message
1	Repeats a message
2	Skips a message
4	New message playback
5	All message playback
7	Re-records a greeting message
8	Continues operation
9	Stops re-recording of a greeting message

Key	Remote command
*4	Erases a specific message
*5	Erases all messages
80	Changes to the TEL mode
81	Turns ON message transfer
82	Turns OFF message transfer
83	Turns ON pager call
84	Turns OFF pager call

Remote Operation (KX-FP185/KX-FM189 only)

Other remote operations

■ Erasing a specific message

Press **[*] 4** while listening to the message you want to erase.

Voice guide example:

The message has been erased.

- A long beep will also sound. The unit will then play back the next message.

■ Erasing all the messages

Press **[*] 5** to erase all the messages.

All messages have been erased.

- A long beep will also sound.

■ Recording a marker message

You can leave an additional message.

1. Wait for the voice guide.

All messages have been played.

2. Wait about 10 seconds.

Please leave your name and message after the beep.

3. Leave a message after the beep.

■ Re-recording a greeting message

You can change the contents of the TAD/FAX greeting message.

1. Press **[7]** to start recording.
 - A long beep will sound.
2. Speak clearly up to 16 seconds.
 - If you pause for over 2 seconds, 6 beeps will sound and the recording will stop. Repeat from step 1 within 10 seconds.
3. When finished recording, press **[9]**.
 - The new greeting message will be played.

■ Skipping the greeting message

Press **[0]** during the greeting message playback.

- The unit will skip the rest of the greeting message.

■ Turning the message transfer on or off

You must pre-program a transfer telephone number beforehand (feature #60 on page 70).

Press **[8] 1** to turn ON the message transfer.

*Message transfer is set.
Transfer phone number is
123456789.*

Press **[8] 2** to turn OFF the message transfer.

Message transfer is off.

- If a transfer telephone number is not programmed, you cannot turn this feature ON.

Transfer phone number is not set.

■ Turning the pager call on or off

You must program a pager number beforehand (feature #70 on page 49).

Press **[8] 3** to turn ON the pager call.

*Pager call is set.
Pager number is 098765432.*

Press **[8] 4** to turn OFF the pager call.

Pager call is off.

- If a pager number is not programmed, you cannot turn this feature ON.

Pager number is not set.

■ Changing the receive mode

Press **[8] 0** to change the receive mode from TAD/FAX to TEL.

- You cannot return to the TAD/FAX mode in the same call. To return to the TAD/FAX mode, see page 46.

Option (KX-FP185/KX-FM189 only)

Transferring recorded messages to another telephone

This feature allows your unit to call a designated telephone number each time an incoming voice message is recorded. You can retrieve the transferred message during the same call using the remote operation.

Program the transfer telephone number first (feature #60 on page 70) and set to the TAD/FAX mode.

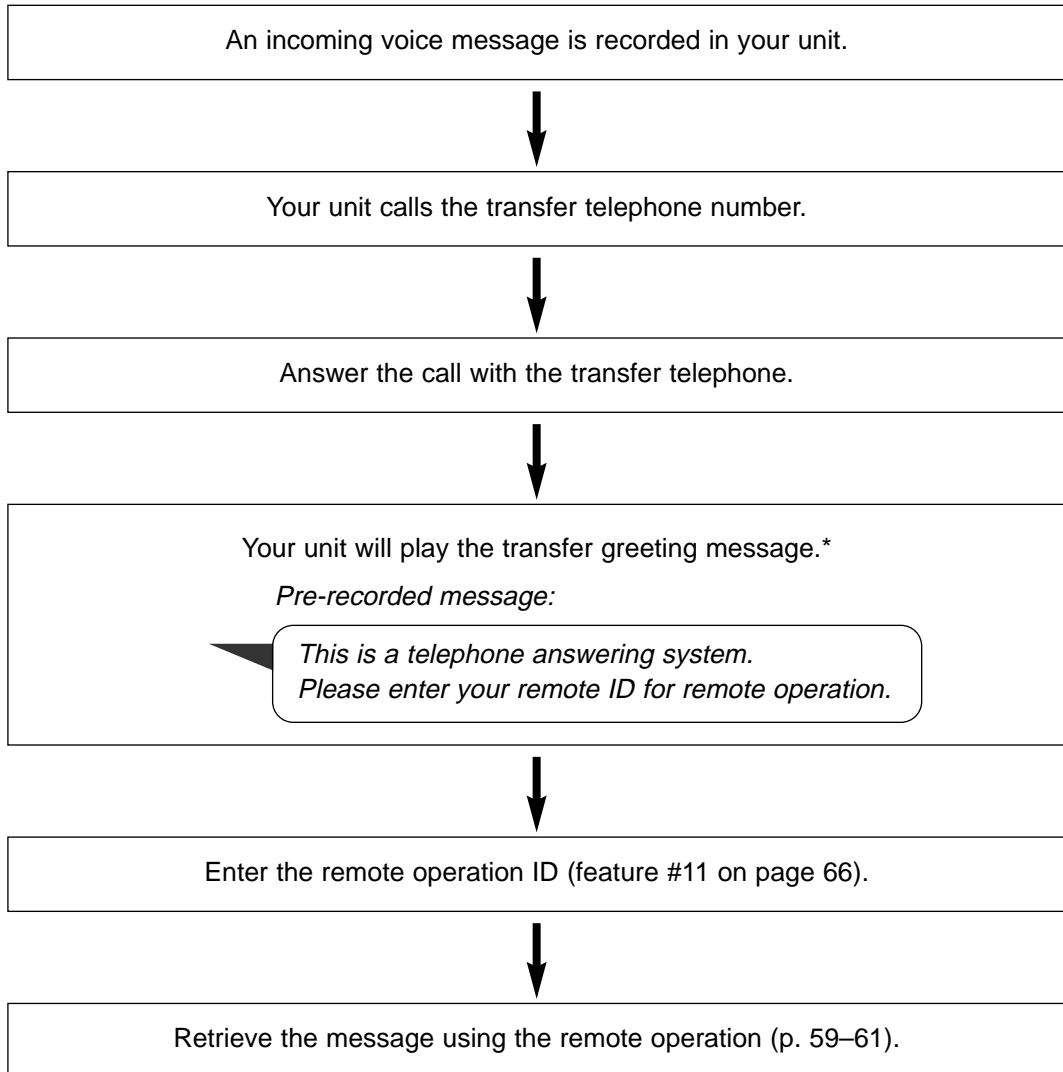

* This message can be changed (see next page).

Option (KX-FP185/KX-FM189 only)

Recording your own transfer greeting message

The recording time is limited to 16 seconds.

Suggested message

"This is a transferred message from (your name, business and/or telephone number). Please enter your remote ID for remote operation."

1 Press **MENU**.
Display: 1.SYSTEM SET UP

2 Press **#**, then **6** **1**.
TRNS-GREETING

3 Press **SET**.
CHECK ↻

4 Rotate **EASY DIAL** to select "RECORD".
RECORD ↻

5 Press **SET**.
TRNS REC. 16s

6 Speak clearly about 20 cm away from the microphone.
• The display will show the remaining recording time.
Example: TRNS REC. 15s

7 When finished recording, press **STOP**.
• The unit will repeat your message.
Adjust the volume using **▲** or **▼**.

8 Press **MENU**.

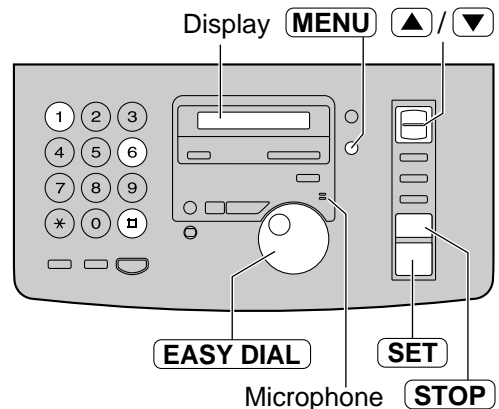

To check your transfer greeting message

1. Press **MENU**, **#** **6** **1**, then **SET**.
2. Rotate **EASY DIAL** to select "CHECK".
3. Press **SET**.
• The unit will play your message.
4. Press **MENU**.

To erase your transfer greeting message

1. Press **MENU**, **#** **6** **1**, then **SET**.
2. Rotate **EASY DIAL** to select "ERASE".
3. Press **SET**.
• Your own message will be erased.
4. Press **MENU**.
• The pre-recorded greeting message will be played when transferring a call.

Features Summary

Programming

The unit provides various programming features. Program the desired setting by referring to the programming tables (p. 65–71).

General programming method

1 Press **MENU**.

Display: 1.SYSTEM SET UP

2 Select the feature you wish to program.

■ **For basic features** (p. 65, 66)

Rotate **EASY DIAL** until the desired feature is displayed.

■ **For advanced features** (p. 67–71)

Rotate **EASY DIAL** until the following is displayed.

ADVANCED MODE

Press **SET** and rotate **EASY DIAL** until the desired feature is displayed.

3 Press **SET**.

• The current setting of the feature will be displayed.

4 Rotate **EASY DIAL** until the desired setting is displayed.

• This step may be slightly different depending on the feature.

5 Press **SET**.

• The setting you selected is set, and the next feature will be displayed.

6 To exit programming, press **MENU**.

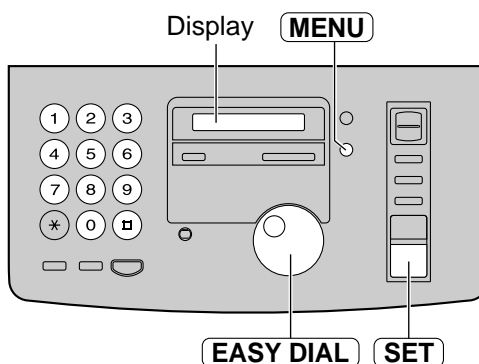

Programming by entering the program code number directly

You can select a feature by directly entering the program code (# and 2-digit number) instead of using **EASY DIAL**.

1. Press **MENU**.

2. Press **#** and the 2-digit code number.

3. Follow steps 3 to 6 above.

• See programming tables (p. 65–71) for codes.

To cancel programming

Press **MENU** to exit the program.

Basic features

Programming table

Code	Display & Feature	Settings	How the unit operates	
#01	<div style="border: 1px solid black; padding: 2px; width: fit-content;">SET DATE & TIME</div> To set the date and time	dd/mm/yy hh:mm (2 digits for each entry)	See page 13 for details.	
#02	<div style="border: 1px solid black; padding: 2px; width: fit-content;">YOUR LOGO</div> To set your logo	(Up to 30 characters)	See pages 14 and 15 for details.	
#03	<div style="border: 1px solid black; padding: 2px; width: fit-content;">YOUR FAX NO.</div> To set your facsimile telephone number	(Up to 20 digits)	See page 16 for details.	
#04	<div style="border: 1px solid black; padding: 2px; width: fit-content;">SENDING REPORT</div> To print and check the sending report for fax transmission results (p. 32)	ERROR	“ERROR”: The sending report will be printed only when fax transmission fails. “ON”: The sending report will be printed after every transmission.	
		ON		
		OFF		
#06	■ For KX-FP181 only <div style="border: 1px solid black; padding: 2px; width: fit-content;">FAX RING COUNT</div> To change the number of rings before the unit answers a call in the FAX ONLY mode	1, 2, 3, 4, 5, 6, 7, 8, 9	If you are using the unit with an answering machine, set the ring count to more than 5.	
#06	■ For KX-FP185/KX-FM189 only <div style="border: 1px solid black; padding: 2px; width: fit-content;">FAX RING COUNT</div> To change the number of rings before the unit answers a call in the FAX ONLY mode	1, 2, 3, 4, 5, 6, 7, 8, 9	This setting can be changed when the unit is in FAX ONLY mode.	
		1, 2, 3, 4	This setting can be changed when the unit is in TAD/FAX mode. ● See page 52 for details.	
		TOLL SAVER		
#06	■ For KX-FP185/KX-FM189 only <div style="border: 1px solid black; padding: 2px; width: fit-content;">TAD RING COUNT</div> To change the number of rings before the unit answers a call in the TAD/FAX mode	RINGER OFF		
		■ For KX-FP185/KX-FM189 only <div style="border: 1px solid black; padding: 2px; width: fit-content;">RECORDING TIME</div> To change the recording time for an incoming message	VOX	“VOX”: Unlimited “1–9”: 1 minute to 9 minutes
			1, 2, 3, 4, 5, 6, 7, 8, 9	

(The default setting is in bold type.) (continued)

Features Summary

Basic features (cont.)

How to set menu options

1. Press **MENU** .
2. Rotate **EASY DIAL** until the desired feature is displayed.
3. Press **SET** .
4. Rotate **EASY DIAL** until the desired setting is displayed.
5. Press **SET** .
6. Press **MENU** .

Note:

- Step 4 may be slightly different depending on the feature.
- See page 64 for more details.

Programming table (cont.)

Code	Display & Feature	Settings	How the unit operates
#11	<p>■ For KX-FP185/KX-FM189 only</p> <div style="border: 1px solid black; padding: 2px; display: inline-block;">REMOTE TAD ID</div> <p>To operate the answering device from a remote location</p>	ON / ID=111	<p>To select "ON" and enter ID:</p> <ol style="list-style-type: none"> 1. Press MENU . 2. Rotate EASY DIAL and select this feature. 3. Press SET . 4. Rotate EASY DIAL to select "ON". 5. Press SET . 6. Enter any 3-digit number except a number using 0 or 7. 7. Press SET . 8. Press MENU .
		OFF	
#12	<p>■ For KX-FP181 only</p> <div style="border: 1px solid black; padding: 2px; display: inline-block;">REMOTE TAM ACT.</div> <p>If you use the unit with an answering machine, activate this feature and set the remote activation ID to secure the remote operation for the answering machine.</p>	ON / ID=11	<p>To select "ON" and enter ID:</p> <ol style="list-style-type: none"> 1. Press MENU . 2. Rotate EASY DIAL and select this feature. 3. Press SET . 4. Rotate EASY DIAL to select "ON". 5. Press SET . 6. Enter your ID from 1 to 5 digits, using 0-9, * and #. 7. Press SET . 8. Press MENU .
		OFF	
#14	<p>■ For KX-FM189 only</p> <div style="border: 1px solid black; padding: 2px; display: inline-block;">PC LINK</div> <p>To set the PC link</p>	ON	See PANA LINK Software Guide for details.
		OFF	

(The default setting is in bold type.)

Advanced features

How to set menu options

1. Press **MENU**.
2. Rotate **EASY DIAL** until "ADVANCED MODE" is displayed.
Press **SET** and rotate **EASY DIAL** until the desired feature is displayed.
3. Press **SET**.
4. Rotate **EASY DIAL** until the desired setting is displayed.
5. Press **SET**.
6. Press **MENU**.

Note:

- Step 4 may be slightly different depending on the feature.
- See page 64 for more details.

Programming table

Code	Display & Feature	Settings	How the unit operates
#22	<div style="border: 1px solid black; padding: 2px; display: inline-block;">AUTO JOURNAL</div> To print the journal report automatically for fax communications	ON	"ON": The unit will print the journal report automatically after every 30 new fax communications (p. 32).
		OFF	
#23	<div style="border: 1px solid black; padding: 2px; display: inline-block;">OVERSEAS MODE</div> If you have difficulty sending an overseas fax, activate this feature before starting transmission. This feature makes sending documents easier as the transmission speed is slowed down.	ON	After transmission, the unit will turn off automatically. <ul style="list-style-type: none"> • This feature is not available for broadcast transmission. • The calling charge may be higher.
		OFF	
#25	<div style="border: 1px solid black; padding: 2px; display: inline-block;">DELAYED SEND</div> To send a fax automatically at a specified time. This allows you to take advantage of low-cost calling hours offered by your telephone company. <ul style="list-style-type: none"> • The setting can be reserved to take place up to 24 hours in advance. 	ON / fax no. / hh:mm	To send a document: <ol style="list-style-type: none"> 1. Insert the document. 2. Follow steps 1–3 above. 3. Rotate EASY DIAL to select "ON". 4. Press SET. 5. Enter the fax number. 6. Press SET. 7. Enter the transmission start time. 8. Press SET. 9. Press MENU. <ul style="list-style-type: none"> • To cancel after programming, press STOP then SET.
		OFF	
#26	■ For KX-FP185/KX-FM189 only <div style="border: 1px solid black; padding: 2px; display: inline-block;">AUTO CALL. LIST</div> To print Caller ID list automatically	ON	"ON": The unit will print the Caller ID list automatically after every 30 new calls (p. 26).
		OFF	
#30	<div style="border: 1px solid black; padding: 2px; display: inline-block;">SILENT FAX RING</div> To change the number of rings when the unit detects a voice call in the TEL/FAX mode	3, 4, 5, 6, 7, 8, 9	See pages 44 and 45 for details.

(The default setting is in bold type.)

(continued)

Features Summary

Advanced features (cont.)

How to set menu options

1. Press **MENU**.
2. Rotate **EASY DIAL** until "ADVANCED MODE" is displayed.
Press **SET** and rotate **EASY DIAL** until the desired feature is displayed.
3. Press **SET**.
4. Rotate **EASY DIAL** until the desired setting is displayed.
5. Press **SET**.
6. Press **MENU**.

Note:

- Step 4 may be slightly different depending on the feature.
- See page 64 for more details.

Programming table (cont.)

Code	Display & Feature	Settings	How the unit operates															
#36	<div style="border: 1px solid black; padding: 2px; width: fit-content;">RCV REDUCTION</div> <p>If the size of the document sent by the other party is as large as, or larger than the recording paper, the unit can reduce and print the document. Select the desired reduction rate.</p>	100%	<table border="1" style="width: 100%; border-collapse: collapse;"> <thead> <tr> <th>Setting</th> <th>Recording paper</th> <th>Original document</th> </tr> </thead> <tbody> <tr> <td>100%</td> <td>A4</td> <td>Letter</td> </tr> <tr> <td>92%</td> <td>A4</td> <td>A4</td> </tr> <tr> <td>86%</td> <td>A4</td> <td>A4</td> </tr> <tr> <td>72%</td> <td>A4</td> <td>Legal</td> </tr> </tbody> </table> <p>• If most of document sent from the other party are as long as your recording paper and they have a long heading using a few lines, we recommend selecting 86%.</p>	Setting	Recording paper	Original document	100%	A4	Letter	92%	A4	A4	86%	A4	A4	72%	A4	Legal
		Setting		Recording paper	Original document													
		100%		A4	Letter													
		92%		A4	A4													
86%	A4	A4																
72%	A4	Legal																
92%																		
86%																		
72%																		
#39	<div style="border: 1px solid black; padding: 2px; width: fit-content;">LCD CONTRAST</div> <p>To adjust the display contrast</p>	NORMAL	<p>"NORMAL": For normal contrast "DARKER": Used when the display contrast is too light.</p>															
		DARKER																
#41	<div style="border: 1px solid black; padding: 2px; width: fit-content;">FAX ACTIVATION</div> <p>If you use an extension telephone and wish to use it to receive a fax, activate this feature, and enter the code (p. 47). • This code is also used to receive a voice message and a fax in the same call (p. 43)(KX-FP181 only).</p>	ON / CODE= * 9	<ol style="list-style-type: none"> 1. Follow steps 1–3 above. 2. Rotate EASY DIAL to select "ON". 3. Press SET. 4. Enter your code from 2 to 4 digits, using 0–9 and *. 5. Press SET. 6. Press MENU. <p>• Do not enter "0000".</p>															
		OFF																
#42	<p>■ For KX-FP185/KX-FM189 only</p> <div style="border: 1px solid black; padding: 2px; width: fit-content;">MESSAGE ALERT</div> <p>To alert you with beeps when a new voice message is recorded</p>	ON	<p>If you hear slow beeps, press PLAY MESSAGES and listen to recorded messages (p. 56). The beeps will stop.</p>															
		OFF																

(The default setting is in bold type.)

Features Summary

Code	Display & Feature	Settings	How the unit operates
#43	<p>■ For KX-FP185/KX-FM189 only</p> <div style="border: 1px solid black; padding: 2px; width: fit-content;">REC. TIME ALERT</div> <p>To alert you with beeps when there is less than 60 seconds of remaining recording time</p>	ON	If you hear slow beeps, erase the recorded messages (p. 57). The beeps will stop.
		OFF	
#44	<div style="border: 1px solid black; padding: 2px; width: fit-content;">RECEIVE ALERT</div> <p>To alert you with beeps when a received document is stored into memory due to a problem.</p>	ON	If you hear slow beeps, clear the printing problem or supply paper to print the stored document. The beeps will stop.
		OFF	
#46	<div style="border: 1px solid black; padding: 2px; width: fit-content;">FRIENDLY RCV</div> <p>To receive a fax automatically when you answer a call and hear a fax calling tone (slow beep).</p>	ON	"ON": You do not have to press FAX START for fax reception.
		OFF	
#47	<p>■ For KX-FP185/KX-FM189 only</p> <div style="border: 1px solid black; padding: 2px; width: fit-content;">FAX GUIDANCE</div> <p>If you wish to hear the voice guidance (see right) at each fax transmission/reception, set this feature to "ON".</p> <ul style="list-style-type: none"> To hear the voice guidance only when fax transmission/reception fails, select "ERROR". 	ON	<p>Voice guidance examples:</p> <p>"Start transmission."</p> <p>"Transmission is complete."</p> <p>"Transmission has failed."</p> <p>"Transmission has been interrupted."</p> <p>"Start reception."</p> <p>"Reception is complete."</p> <p>"Reception has failed."</p> <p>"Reception has been interrupted."</p> <p>"Please hang up the handset for reception."</p> <p>"Start reception."</p>
		OFF	
		ERROR	
#49	<p>■ For KX-FP181 only</p> <div style="border: 1px solid black; padding: 2px; width: fit-content;">AUTO DISCONNECT</div> <p>To answer a call with an extension telephone in the TEL/FAX mode (p. 45)</p>	ON / CODE= * 0	<ol style="list-style-type: none"> Follow steps 1–3 on page 68. Rotate EASY DIAL to select "ON". Press SET. Enter your code from 2 to 4 digits, using 0–9 and *. Press SET. Press MENU.
		OFF	
#54	<p>■ For KX-FP185/KX-FM189 only</p> <div style="border: 1px solid black; padding: 2px; width: fit-content;">GREETING TIME</div> <p>To change the recording time for your own TAD/FAX greeting message (p. 54)</p>	16s	<p>"16s": Up to 16 seconds</p> <p>"60s": Up to 60 seconds</p>
		60s	

(The default setting is in bold type.) (continued)

Features Summary

Advanced features (cont.)

How to set menu options

1. Press **MENU**.
2. Rotate **EASY DIAL** until "ADVANCED MODE" is displayed.
Press **SET** and rotate **EASY DIAL** until the desired feature is displayed.
3. Press **SET**.
4. Rotate **EASY DIAL** until the desired setting is displayed.
5. Press **SET**.
6. Press **MENU**.

Note:

- Step 4 may be slightly different depending on the feature.
- See page 64 for more details.

Programming table (cont.)

Code	Display & Feature	Settings	How the unit operates
#60	■ For KX-FP185/KX-FM189 only <div style="border: 1px solid black; padding: 2px; display: inline-block;">MESSAGE TRANS.</div> To transfer a recorded incoming message to another telephone (p. 62)	ON	1. Follow steps 1–3 above. 2. Rotate EASY DIAL to select "ON". 3. Press SET . 4. Enter the transfer telephone number. 5. Press SET . 6. Press MENU . • This feature can be turned on/off from a remote location (p. 61).
		OFF	
#61	■ For KX-FP185/KX-FM189 only <div style="border: 1px solid black; padding: 2px; display: inline-block;">TRNS-GREETING</div> To check, record or erase a transfer greeting message	CHECK	See page 63 for details.
		RECORD	
		ERASE	
#67	■ For KX-FP185/KX-FM189 only <div style="border: 1px solid black; padding: 2px; display: inline-block;">ICM MONITOR</div> To hear an incoming message (ICM) from the speaker while the answering device is recording the message	ON	If you select "OFF", you cannot monitor the incoming message.
		OFF	
#68	<div style="border: 1px solid black; padding: 2px; display: inline-block;">ECM SELECTION</div> ECM stands for Error Correction Mode. To send a fax even if there is static interference on the telephone line	ON	This feature is available when the transmitting/receiving station are ECM compatible. • If the documents are in memory, clear them before the setting (p. 40).
		OFF	

(The default setting is in bold type.)

Features Summary

Code	Display & Feature	Settings	How the unit operates
#70	<div style="border: 1px solid black; padding: 2px; display: inline-block;">FAX PAGER CALL</div> (KX-FP181) <div style="border: 1px solid black; padding: 2px; display: inline-block;">PAGER CALL</div> (KX-FP185/ KX-FM189) If you have a pager and wish to know when your unit receives an incoming message (KX-FP185/KX-FM189 only) or a fax, activate this feature.	ON	See page 49 for details.
		OFF	
#71	<div style="border: 1px solid black; padding: 2px; display: inline-block;">MELODY RINGER</div> To set the ring melody	A	
		B	
		C	
#76	<div style="border: 1px solid black; padding: 2px; display: inline-block;">CONNECTING TONE</div> If you often have trouble when sending a fax, this feature allows you to hear connecting tones; fax tone, ring back tone and busy tone.	ON	You can confirm the status of the other party's machine. <ul style="list-style-type: none"> ● If the ring back tone continues, the other party's machine may not be a facsimile or may have run out of paper. Check with the other party. ● The connecting tone volume cannot be adjusted.
		OFF	
#77	■ For KX-FP181 only <div style="border: 1px solid black; padding: 2px; display: inline-block;">AUTO ANSWER</div> To change the receive mode in the AUTO ANSWER setting	FAX ONLY	"FAX ONLY": Facsimile only mode (p. 41) "TEL/FAX": Telephone/Facsimile mode (p. 44, 45)
		TEL/FAX	
#77	■ For KX-FP185/KX-FM189 only <div style="border: 1px solid black; padding: 2px; display: inline-block;">AUTO ANSWER</div> To change the receive mode in the AUTO ANSWER setting	TAD/FAX	"TAD/FAX": Telephone Answering Device/Facsimile mode (p. 52) "FAX ONLY": Facsimile only mode (p. 41) "TEL/FAX": Telephone/Facsimile mode (p. 44, 45)
		FAX ONLY	
		TEL/FAX	
#78	<div style="border: 1px solid black; padding: 2px; display: inline-block;">TEL/FAX RING</div> If you use an extension telephone in the TEL/FAX mode, select the desired number of rings of the extension telephone.	1, 2, 3, 4, 5, 6, 7, 8, 9	See pages 44 and 45 for details.
#80	<div style="border: 1px solid black; padding: 2px; display: inline-block;">SET DEFAULT</div> To reset the advanced features, except ECM selection (feature #68 on page 70) to their default settings	YES	<ol style="list-style-type: none"> 1. Follow steps 1–3 on page 70. 2. Rotate EASY DIAL to select "YES". 3. Press SET . 4. Press SET again. 5. Press MENU .
		NO	

(The default setting is in bold type.)

Error Messages

Reports

If your unit cannot send a fax, check the following.

- The number you dialled is correct.
- The other party's machine is a facsimile.

If the problem remains, correct it by following the communication message printed on the sending and journal reports (p. 32).

Communication message	Error code	Cause & Remedy
COMMUNICATION ERROR	40–42 46–52 58, 65 68, 72 FF	● A transmission or reception error occurred. Try again or check with the other party.
	43 44	● An overseas transmission error occurred. Try using the overseas mode (feature #23 on page 67).
DOCUMENT JAMMED	—	● The document is jammed. Remove the jammed document (p. 81).
ERROR-NOT YOUR UNIT	54 59 70	● A transmission or reception error occurred because of a problem with the other party's fax machine. Check with the other party.
MEMORY FULL	—	● The document was not received due to memory being full.
NO DOCUMENT	—	● The document was not fed into the unit properly. Reinsert the document and try again.
OTHER FAX NOT RESPOND	—	<ul style="list-style-type: none">● The other party's fax machine is busy or has run out of recording paper. Try again.● The document was not fed properly. Reinsert the document and try again.● The other party's fax machine rings too many times. Send a fax manually – dial the number, confirm the fax tone, and press FAX START.● The other party's machine is not a facsimile. Check with the other party.● The number you dialled is not in service.
PC FAIL OR BUSY (KX-FM189 only)	—	● The PC cannot control the fax functions. The printer cable is not connected correctly, or the software is not running on the PC.
PRESSED THE STOP KEY	—	● STOP was pressed and fax communication was cancelled.
THE COVER WAS OPENED	—	● The covers were opened. Close them and try again.
OK	—	● Fax communication was successful.

Display

If the unit detects a problem, one or more of the following messages will appear on the display.

Display message	Cause & Remedy
CALL SERVICE CALL SERVICE2	<ul style="list-style-type: none"> ● There is something wrong with the unit. Contact our service personnel.
COVER OPEN ↕ CHECK FILM	<ul style="list-style-type: none"> ● The covers are open. Close them. ● The ink film is empty. Replace the ink film with a new one (p. 83, 84). ● The ink film is not installed. Install it (p. 83, 84). ● The ink film is slack. Tighten it (see step 6 on page 84).
CHECK DOCUMENT	<ul style="list-style-type: none"> ● The document is not fed into the unit properly. Reinsert the document. If misfeeding occurs frequently, clean the document feeder rollers (p. 82) and try again. If the problem remains, adjust the feeder pressure (p. 81).
CHECK MEMORY	<ul style="list-style-type: none"> ● Memory (telephone numbers, parameters, etc.) has been erased. Re-program.
CHECK PAPER	<ul style="list-style-type: none"> ● The recording paper is not installed or the unit has run out of paper. Install paper and press SET to clear the message. ● The recording paper is not fed into the unit properly. Reinstall paper (p. 11) and press SET to clear the message. ● The recording paper has jammed near the recording paper entrance. Clear the jammed paper (p. 80) and press SET to clear the message. Do not install folded or heavily curled paper.
EASY DIAL FULL	<ul style="list-style-type: none"> ● There is no space to store new stations in the EASY DIAL directory. Erase unnecessary stations (p. 22).
FAX IN MEMORY	<ul style="list-style-type: none"> ● The unit has a document in memory. See the other displayed message instructions to print out the document.
FAX MEMORY FULL	<ul style="list-style-type: none"> ● Memory is full of received documents due to a lack of recording paper or a recording paper jam etc. Install paper or clear the jammed paper. ● When performing memory transmission, the document being stored exceeds the memory capacity of the unit. Transmit the entire document manually.

Error Messages

Display message	Cause & Remedy
MEMORY FULL	<ul style="list-style-type: none">● When making a copy, the document being stored exceeds the memory capacity of the unit. Press STOP to clear the message. Divide the document and try again.
MESSAGE FULL	<ul style="list-style-type: none">● There is no memory left to record a voice message. Erase unnecessary messages (p. 57) (KX-FP185/KX-FM189 only).
MODEM ERROR	<ul style="list-style-type: none">● There is something wrong with the modem circuit. Contact our service personnel.
NO FAX REPLY	<ul style="list-style-type: none">● The other party's fax machine is busy or has run out of recording paper. Try again.
PAPER JAMMED	<ul style="list-style-type: none">● A recording paper jam occurred. Clear the jammed paper (p. 80).
PC FAIL OR BUSY	<ul style="list-style-type: none">● The fax function cannot be operated by the PC. The RS232C cable is not connected correctly, or the software is not running on the PC (KX-FM189 only).
PLEASE WAIT	<ul style="list-style-type: none">● The unit is checking that there is no slack on the ink film. Wait for a while.
POLLING ERROR	<ul style="list-style-type: none">● The other party's fax machine does not provide the polling function. Check with the other party.
REDIAL TIME OUT	<ul style="list-style-type: none">● The other party's fax machine is busy or has run out of recording paper. Try again.
REMOVE DOCUMENT	<ul style="list-style-type: none">● The document is jammed. Remove the jammed document (p. 81).● Attempted to transmit a document longer than 600 mm. Press STOP to remove the document. Divide the document into two or more sheets and try again.
TRANSMIT ERROR	<ul style="list-style-type: none">● A transmission error occurred. Try again.
UNIT OVERHEATED	<ul style="list-style-type: none">● The unit is too hot. Let the unit cool down.

When a function does not work, check here before requesting help

General

Problem	Cause & Remedy
I cannot make and receive calls.	<ul style="list-style-type: none"> ● The mains lead or telephone line cord is not connected. Check the connections (p. 12). ● If you used a splitter to connect the unit, remove the splitter and connect the unit to the wall jack directly. If the unit operates properly, check the splitter.
The unit does not work.	<ul style="list-style-type: none"> ● Disconnect the unit from the telephone line and connect the line to a known working telephone. If the working telephone operates properly, contact our service personnel to have the unit repaired. If the working telephone does not operate properly, contact your telephone company.
The unit does not ring.	<ul style="list-style-type: none"> ● The ringer volume is set to off. Adjust it (p. 17). ● The TAD ring count of feature #06 is set to "RINGER OFF". Change to another ring count (p. 65)(KX-FP185/KX-FM189 only).
The unit displays the following message though the paper is inserted. <div style="border: 1px solid black; padding: 5px; width: fit-content; margin: 5px auto;">CHECK PAPER</div>	<ul style="list-style-type: none"> ● The paper is inserted halfway. Insert it correctly (p. 11) and press SET to clear the message.
The other party complains they only hear a fax tone and cannot talk.	<ul style="list-style-type: none"> ● The FAX ONLY mode is set. Tell them the number is only used for faxes or change to TEL, TEL/FAX or TAD/FAX (KX-FP185/KX-FM189 only) mode (p. 38, 39).
The speakerphone is not working. (KX-FP185/KX-FM189 only)	<ul style="list-style-type: none"> ● Use the speakerphone in a quiet room. ● If you have difficulty hearing the other party, adjust the volume using ▲ or ▼. ● If you and the other party speak at the same time, parts of your conversation will be cut off. Speak alternately.
The REDIAL/PAUSE button does not function properly.	<ul style="list-style-type: none"> ● If this button is pressed during dialling, a pause will be inserted. If pressed immediately after a dial tone is obtained, the last number dialled will be redialled.
During programming, I cannot enter the code or ID number.	<ul style="list-style-type: none"> ● All or part of the numbers are the same. Change the code or ID number of features #11 (p. 66), #12 (p. 66), #41 (p. 68) and #49 (p.69).
The ink film runs out quickly.	<ul style="list-style-type: none"> ● The HELP printing function, copy function, and reports also use ink film.
The unit beeps.	<ul style="list-style-type: none"> ● Recording paper or ink film has run out. Press STOP to stop the beeps and install paper/ink film.

Operations

Fax – sending

Problem	Cause & Remedy
I cannot send documents.	<ul style="list-style-type: none"> ● The telephone line cord is connected to the EXT jack on the unit. Connect to the LINE jack (p. 12) (KX-FP181 only). ● The other party's fax machine is busy or has run out of recording paper. Try again. ● The other party's machine is not a facsimile. Check with the other party. ● The other party's fax machine rings too many times. Send a fax manually – dial the number, confirm the fax tone, then press FAX START.
The other party complains that letters on their received document are distorted or not clear.	<ul style="list-style-type: none"> ● If your line has special telephone services such as call waiting, the service may have been activated during fax transmission. Connect the unit to a line that does not have these services. ● The extension telephone on the same line is off the hook. Hang up the extension telephone and try again. ● Try copying the document. If the copied image is clear, there may be something wrong with the other party's machine.
The other party complains that dirty patterns or black lines appear on their received document.	<ul style="list-style-type: none"> ● The glass or rollers are dirty. Clean them (p. 82).
I cannot make an international fax call.	<ul style="list-style-type: none"> ● Use the overseas transmission mode of feature #23 (p. 67). ● Add two pauses at the end of the telephone number (p. 19) or dial manually.

Fax – receiving

Problem	Cause & Remedy
I cannot receive documents. (KX-FP181 only)	<ul style="list-style-type: none"> ● The telephone line cord is connected to the EXT jack on the unit. Connect to the LINE jack (p. 12).
I cannot receive documents automatically.	<ul style="list-style-type: none"> ● The receive mode is set to the TEL mode. Set to the FAX ONLY, TEL/FAX or TAD/FAX (KX-FP185/KX-FM189 only) mode (p. 38, 39). ● The time taken to answer the call is too long. Decrease the number of rings of features #06 (p. 65), #30 (p. 67) and #78 (p. 71). ● The greeting message is too long. Shorten the message (p. 54)(KX-FP185/KX-FM189 only).
The display shows the following message but faxes are not received. <div style="border: 1px solid black; padding: 2px; width: fit-content;">CONNECTING.....</div>	<ul style="list-style-type: none"> ● The incoming call is not a fax. Change the receive mode to the TEL or TAD/FAX (KX-FP185/KX-FM189 only) mode (p. 38, 39).

(continued)

Fax – receiving (cont.)

Problem	Cause & Remedy
The recording image is faint.	<ul style="list-style-type: none"> The other party sent a faint document. Ask them to send a clearer copy of the document. The thermal head is dirty. Clean it (p. 82).
The printing quality is poor.	<ul style="list-style-type: none"> Some paper has instructions recommending which side to print on. Try turning the paper over. Check the document of the other party.
A blank sheet is ejected.	<ul style="list-style-type: none"> If a blank sheet is ejected after the received document is printed out, the receiving reduction rate is not programmed correctly. Program the proper rate in feature #36 (p. 68). The other party placed the document in their fax machine the wrong way. Check with the other party.

Receive mode

Problem	Cause & Remedy
I cannot select the desired receive mode.	<ul style="list-style-type: none"> If you want to set the FAX ONLY, TEL/FAX or TAD/FAX (KX-FP185/KX-FM189 only) mode: <ul style="list-style-type: none"> Select the desired mode using feature #77 (p. 71), and Press AUTO ANSWER to turn on the arrow (▼) on the right of the display. <p style="text-align: right;">Display: <input type="text"/> ▼ ON</p> If you want to set the TEL mode: <ul style="list-style-type: none"> Press AUTO ANSWER to turn off the arrow (▼) on the right of the display. <p style="text-align: right;"><input type="text"/> ON</p>
The other party complains that they cannot send a document.	<ul style="list-style-type: none"> The unit is not in AUTO ANSWER mode. Press AUTO ANSWER to turn on the arrow (▼) on the right of the display. <p style="text-align: right;"><input type="text"/> ▼ ON</p>

Copying

Problem	Cause & Remedy
The unit does not make a copy.	<ul style="list-style-type: none"> You cannot make a copy during programming. Make the copy after programming or stop the programming.
A dirty pattern or a black line appears on the copied document.	<ul style="list-style-type: none"> The glass or rollers are dirty. Clean them (p. 82).
The copied image is distorted.	<ul style="list-style-type: none"> The thermal head is dirty. Clean it (p. 82).

(continued)

Operations

Copying (cont.)

Problem	Cause & Remedy
The printing quality is poor.	<ul style="list-style-type: none">● Some paper has instructions recommending which side to print on. Try turning the paper over.
The printing is faint. Original Copy 	<ul style="list-style-type: none">● You may have used paper with a cotton and/or fiber content that is over 20%, such as letterhead or resume paper.

Using an answering machine (KX-FP181 only)

Problem	Cause & Remedy
I cannot receive documents automatically.	<ul style="list-style-type: none">● Your greeting message on the answering machine is too long. Shorten the message (up to 10 seconds).● The answering machine rings too many times. Set to 1 or 2 rings.
I cannot receive voice messages.	<ul style="list-style-type: none">● Check if the answering machine is turned on and connected to the fax machine properly (p. 42).● Set the number of rings on the answering machine to 1 or 2.
I cannot retrieve recorded voice messages on the answering machine from a remote location.	<ul style="list-style-type: none">● The remote access code on your answering machine is the same as your fax activation code. Set a different number for features #12 (p. 66) and #41 (p. 68).● You did not program your remote access code in your fax machine correctly. Program the same code that is programmed on the answering machine to the fax machine with feature #12 (p. 66).
I pressed the remote access code to access the answering machine remotely, but the line was disconnected.	<ul style="list-style-type: none">● The code may include “#” which is used for certain features provided by telephone companies. Change the code on the answering machine to another number which does not include “#”. Also change the code of the fax machine with feature #12 (p. 66).
Callers complain that they cannot send a document.	<ul style="list-style-type: none">● Your answering machine has run out of recording tape. Rewind the tape to record messages.● You set the answering machine to only give a greeting message.

Answering device (KX-FP185/KX-FM189 only)

Problem	Cause & Remedy
New voice messages cannot be recorded in the TAD/FAX mode.	<ul style="list-style-type: none"> The memory is full. Erase unnecessary messages (p. 57).
I cannot retrieve recorded messages from a remote location.	<ul style="list-style-type: none"> Press the remote operation ID (feature #11 on page 66) correctly and firmly.

If a power failure occurs

- The unit will not function.
- The unit is not designed for making emergency telephone calls when the power fails. Alternative arrangements should be made for access to emergency services.
- Fax transmission and reception will be interrupted.
- If delayed transmission of feature #25 (p. 67) is programmed and the start time has passed during a power failure, transmission will be attempted soon after power is restored.
- If an extension telephone/answering machine is connected to the EXT jack of the fax machine, you may be able to use it during a power failure (KX-FP181 only).
- If fax documents are stored in memory, they will be lost. When power is restored, a power down report will be printed out stating which contents in memory have been erased.

Sample of a power down report

POWER DOWN REPORT				
			POWER DOWN AT:05 Jan. 2000 04:30	
			RESTARTED AT:05 Jan. 2000 04:31	
			YOUR LOGO :	
			YOUR FAX NO. :	
<< WARNING >>				
CONTENTS HAVE BEEN CLEARED DUE TO POWER DOWN.				
FOR ADDITIONAL INFORMATION, PLEASE SEE THE JOURNAL REPORT.				
NO.	OTHER FACSIMILE	MODE	PAGES	FUNCTION
01	<FAX # NOT AVAIL.>	RCV	01	MEMORY RECEIVE

Recording paper jam

If the unit does not eject any recording paper during fax reception or copying, the recording paper has jammed and the display will show the following message.

Display: PAPER JAMMED

Remove the jammed paper as follows.

- 1 Open the front cover by pulling up the centre part.

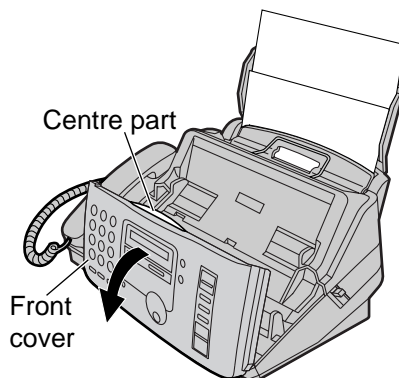

- 2 Push the back cover open button (1) and open the back cover (2).

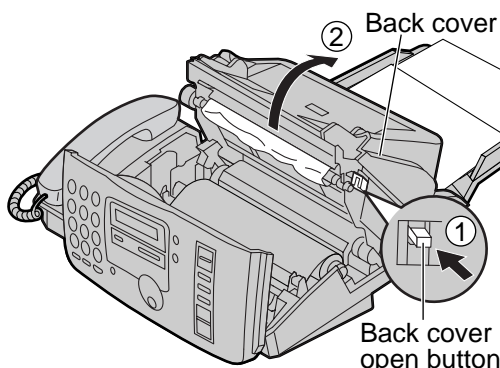

- 3 Remove the jammed recording paper.

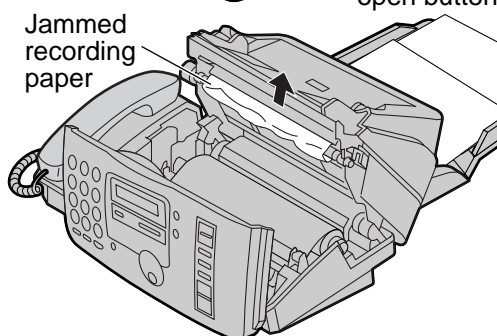

- 4 If the ink film is slack, tighten it by winding the gear.

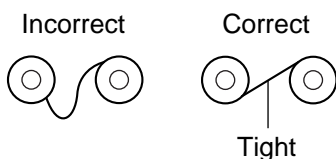

- 5 Close the back cover securely by pushing down on the dotted area at both ends (1). Close the front cover securely (2).

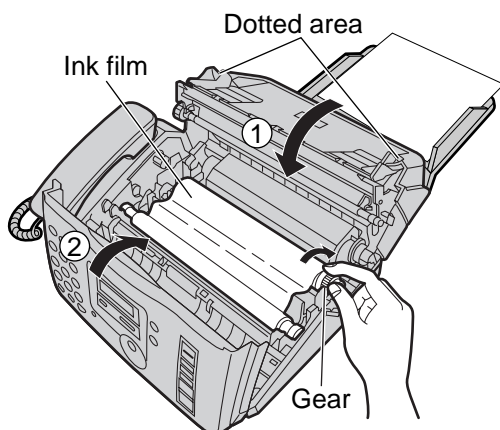

Sending document jams

If the unit does not release the document during feeding, remove the jammed document as follows.

- 1** Open the front cover by pulling up the centre part.
- 2** Remove the jammed document carefully.
- 3** Close the front cover securely.

Note:

- Do not pull out the jammed paper forcibly before opening the front cover.

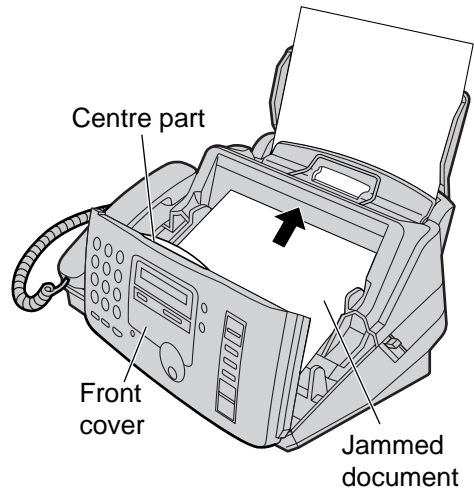
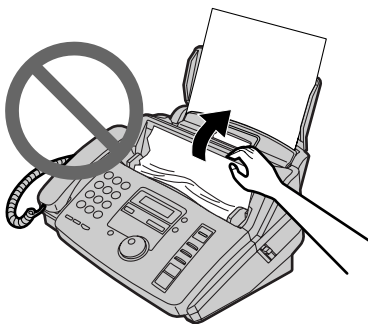

Sending document does not feed, or multi-feeds

If no feeding or multiple feeding occurs frequently, adjust the feeder pressure.

- 1** Open the front cover by pulling up the centre part.
- 2** Shift the position of the green lever by using an instrument with a pointed end, such as a paper clip.
 - Left:** When documents multiple feed.
 - Centre:** Standard position (pre-selected)
 - Right:** When documents do not feed.
- 3** Close the front cover securely.

Note:

- When shifting the green lever, do not touch the rubber flap.

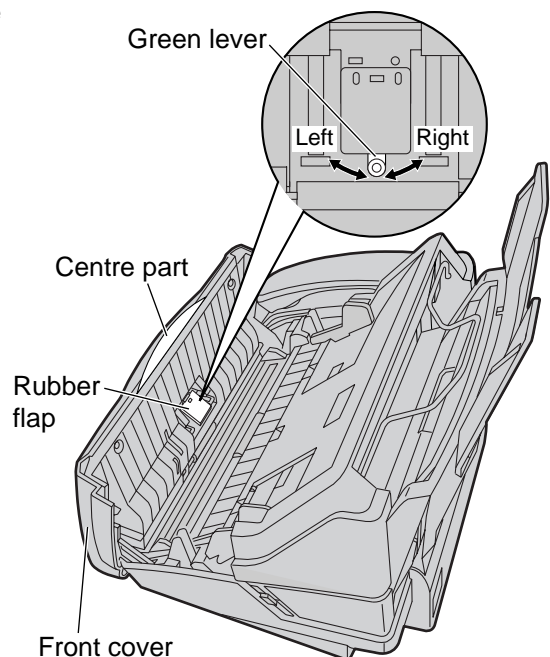

Cleaning

Document feeder

If misfeeding occurs frequently or if dirty patterns or black bands appear on a transmitted document or on the original of a copied document, clean the document feeder.

- 1** Disconnect the mains lead and the telephone line cord.
- 2** Open the front cover by pulling up the centre part.
- 3** Clean the document feeder rollers and rubber flap with a cloth moistened with isopropyl rubbing alcohol, and let all parts dry thoroughly.
- 4** Clean the glass with a soft dry cloth.
- 5** Close the front cover securely.
- 6** Connect the mains lead and the telephone line cord.

Caution:

- Do not use paper products, such as paper towels or tissues, to clean the inside of the unit.

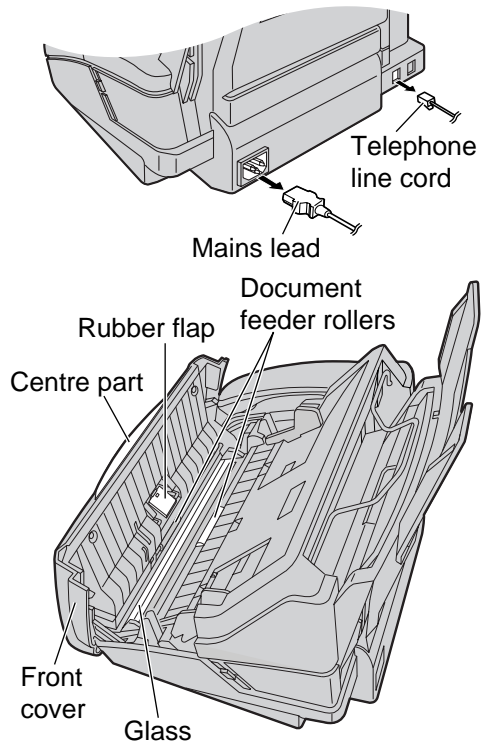

Thermal head

If dirty patterns or black or white bands appear on a copied or received document, clean the thermal head.

- 1** Disconnect the mains lead and the telephone line cord.
- 2** Open the front cover by pulling up the centre part.
- 3** Open the back cover by pushing the back cover open button.
- 4** Clean the thermal head with a cloth moistened with isopropyl rubbing alcohol, and let it dry thoroughly.
- 5** Close the back cover securely by pushing down on the dotted area at both ends. Close the front cover securely.
- 6** Connect the mains lead and the telephone line cord.

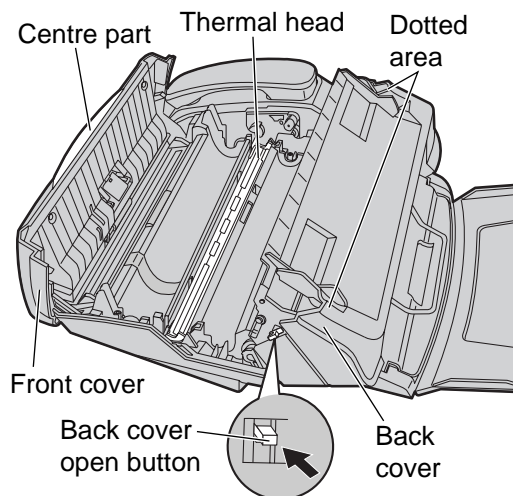

Caution:

- To prevent malfunction due to static electricity, do not use a dry cloth and do not touch the thermal head directly.

Replacing the ink film

When the unit runs out of ink film, the following message will be displayed.

Display:

CHECK FILM

Install a new ink film. The following ink film is available for replacement. Each roll prints about 140 A4 size pages. See page 6 for accessory information.

Model No. KX-FA55X: Replacement film (2 rolls)

- 1 Open the front cover by pulling up the centre part.

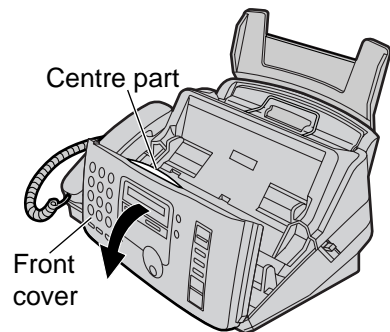

- 2 Push the back cover open button (①) and open the back cover (②).

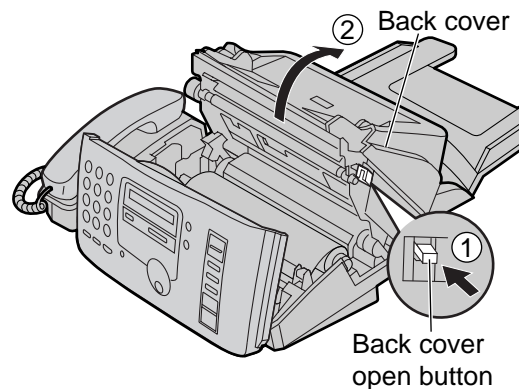

- 3 Pull up the blue gear side and remove the used ink film. Remove the used core.

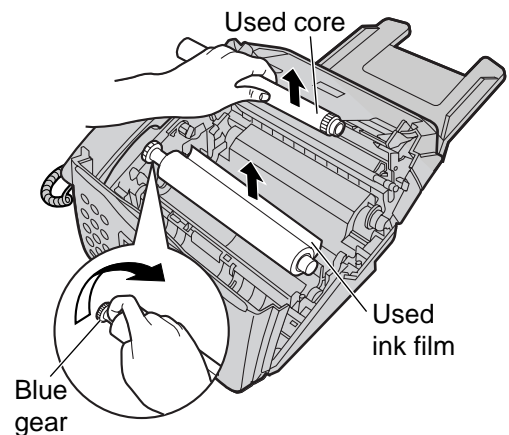

Ink Film

- 4** Remove the stoppers and tags from the new ink film. Find the "T" shaped gear (blue).

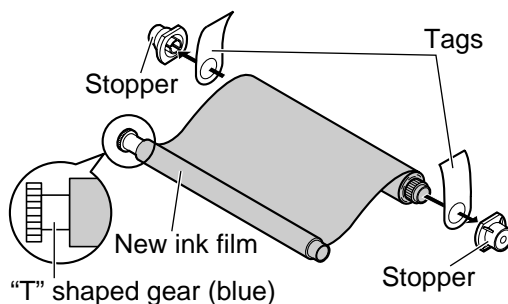

- 5** Insert the blue core of the front ink film roll into the right slot of the unit (①). Insert the "T" shaped gear (blue) into the left slot of the unit (②). Insert the back ink film roll (③).

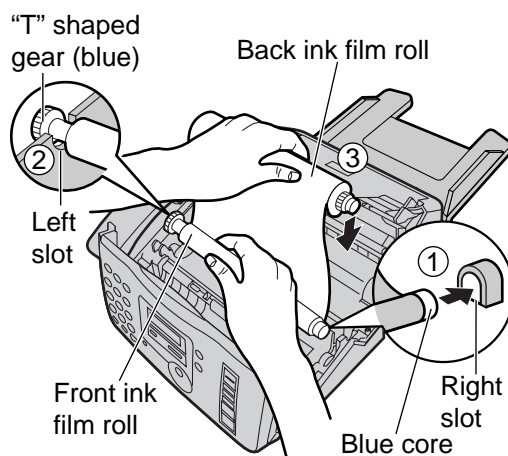

- 6** If the ink film is slack, tighten it by winding the gear.

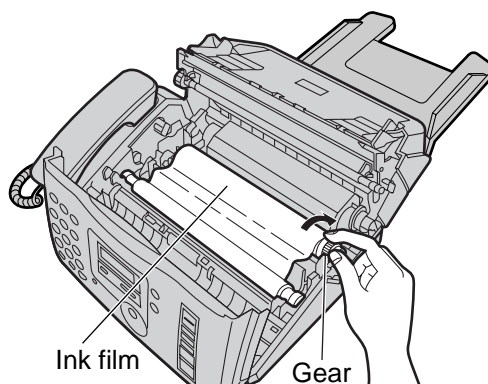
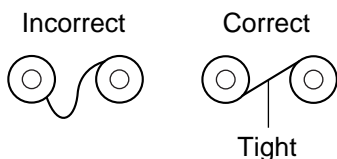

- 7** Close the back cover securely by pushing down on the dotted area at both ends (①). Close the front cover securely (②).

- The following message will be displayed while the unit is checking that there is no slack on the ink film.

Display: PLEASE WAIT

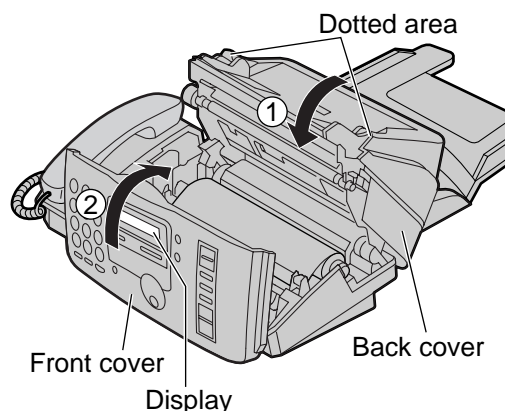

Note:

- The ink film is completely safe to touch, and will not rub off on your hands like carbon paper.

Reference lists and reports

You can print out the following lists and reports for your reference.

Setup list: provides you with the current settings of the basic and advanced programming features (p. 65–71).

Telephone number list: provides you with names and telephone numbers which are stored in the EASY DIAL directory. The telephone number codes are as shown below.

P: A pause has been entered.

F: A recall has been entered.

Journal report: keeps records of fax transmission and reception. This report will be printed automatically after every 30 fax communications (p. 32).

Printer test list: allows you to check the print quality of your unit. If the test print has a dirty pattern, or blurred points or lines, clean the thermal head (p. 82).

Broadcast programming list: provides you with names and telephone numbers which are stored in the broadcast feature (p. 35).

Caller ID list (KX-FP185/KX-FM189 only): keeps records of the last 30 callers after subscribing to a Caller ID service. This report will be printed automatically after every 30 callers (p. 26).

1 Press **MENU** twice.

Display: 2.PRINT REPORT

2 Rotate **EASY DIAL** until the desired item is displayed.

SETUP LIST

TEL NO. LIST

JOURNAL REPORT

PRINTER TEST

BROADCAST LIST

CALLER ID LIST

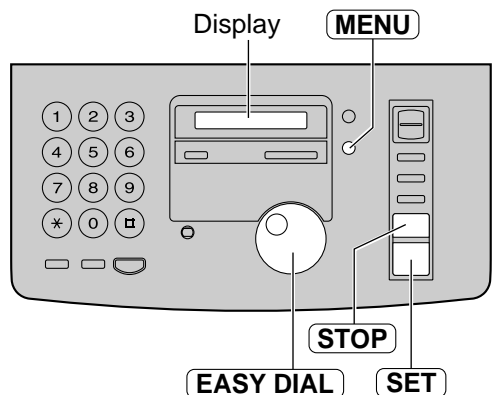

3 Press **SET** to start printing.

PRINTING

- To stop printing, press **STOP**.
- After printing, the printed item will be displayed.

4 Press **MENU**.

Specifications

Technical data about this product

Applicable Lines:	Public Switched Telephone Network
Document Size:	Max. 216 mm in width / Max. 600 mm in length
Effective Scanning Width:	208 mm
Recording Paper Size:	A4: 210 mm x 297 mm
Effective Printing Width:	202 mm
Transmission Time**:	■ KX-FP181: Approx. 12 s/page (Original mode)** ■ KX-FP185/KX-FM189: Approx. 8 s/page (Original mode)**
Scanning Density:	Horizontal: 8 pels/mm Vertical: 3.85 lines/mm –“STANDARD” mode 7.7 lines/mm –“FINE”/“HALF TONE” mode 15.4 lines/mm –“SUPER FINE” mode
Halftone Level:	64-level
Scanner Type:	Contact Image Sensor (CIS)
Printer Type:	Thermal Transfer on plain paper
Data Compression System:	Modified Huffman (MH), Modified READ (MR), Modified Modified READ (MMR)
Modem Speed:	■ KX-FP181: 9,600 / 7,200 / 4,800 / 2,400 bps; Automatic Fallback ■ KX-FP185/KX-FM189: 14,400 / 12,000 / 9,600 / 7,200 / 4,800 / 2,400 bps; Automatic Fallback
Operating Environment:	5 °C – 35 °C, 20 % – 80 % RH (Relative Humidity)
Dimensions (H x W x D):	185 mm x 345 mm x 276 mm
Mass (Weight):	Approx. 3.75 kg
Power Consumption:	Standby: ■ KX-FP181: Approx. 5 W ■ KX-FP185/KX-FM189: Approx. 6 W Transmission: Approx. 20 W Reception: Approx. 40 W (When receiving a 20% black document) Copy: Approx. 40 W (When copying a 20% black document) Maximum: Approx. 120 W (When copying a 100% black document)
Power Supply:	220–240 V AC, 50 Hz
Memory Capacity:	Voice memory (KX-FP185/KX-FM189 only): Approx. 18 minutes of recording time including greeting message*** Fax memory: Approx. 28 pages of memory reception Approx. 25 pages of memory transmission (Based on the ITU-T No. 1 Test Chart in standard resolution, without using the Error Correction Mode.)

* Transmission speed depends upon the contents of the pages, resolution, telephone line conditions and capability of the other party's machine.

** Transmission speed mentioned here is based upon the ITU-T No. 1 Test Chart and original mode.
If the capability of the other party's machine is inferior to your unit, the transmission time may be longer.

*** Recording time may be reduced by the calling party's background noise.

Note:

- Any details given in these instructions are subject to change without notice.
- The pictures and illustrations in these instructions may vary slightly from the actual product.

ITU-T No. 1 Test Chart

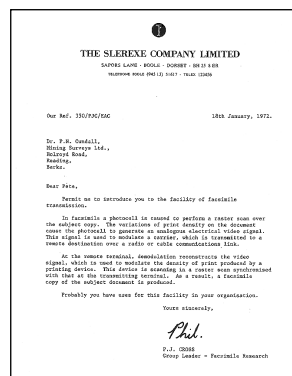

Important Information

The connection to the telecommunication systems must not be hard wired and must be unplugged before the earth is disconnected.

Method of connection

This apparatus is connected to the exchange line or PABX/PMBX extension by the new standard British Telecom plug and socket. Arrangements for provision of this type of termination can be made through the nearest British Telecom Sales Office.

This apparatus may be connected to the following types of installation.

- a) For connection to the public switched telephone network (PSTN) and compatible (Private Branch Exchange), which use DTMF signalling. (Please consult your supplier for an up to date list of compatible PBX's.)
- b) The apparatus can be used on extension sockets connected to a direct exchange line (D.E.L.).
- c) This apparatus is suitable for connection to the telecommunication system directly or via compatible private branch exchange as an extension. The supplier of the apparatus should be consulted for an up to date list of PBX's with which the apparatus is compatible.

It cannot be guaranteed that the apparatus will operate under all possible conditions of connection to compatible PBX's.

- This apparatus is suitable for connection to a PBX with or without initial proceed indication.
- This apparatus is suitable for connection to a PBX with or without secondary proceed indication.

Any cases of difficulty should be referred in the first instance to the supplier of the apparatus.

- d) The apparatus must not be connected in the following manner:
 - As an extension to a pay phone
 - As a party line with shared service

NOTES:

- If you experience any problems with the normal use of your apparatus, you should unplug it from the telephone outlet and connect a known working telephone in its place. If the known working telephone still gives problems, then please contact the customer service department of your PSTN operator (e.g. BT etc.). If it operates properly, then the problems are likely to be a fault in your apparatus. In this case, consult your supplier for advice.
- Your PSTN operator may charge you if they attend a service call that is not due to apparatus supplied by them.

Important Information

Fitting a plug to the mains lead

This appliance is supplied with a moulded three pin mains plug for your safety and convenience.

A 5 amp fuse is fitted in this plug.

Should the fuse need to be replaced please ensure that the replacement fuse has a rating of 5 amps and that it is approved by ASTA or BSI to BS1362.

Check for ASTA mark  or the BSI

mark  on the body of the fuse.

If the plug contains a removable fuse cover you must ensure that it is refitted when the fuse is replaced.

If you lose the fuse cover the plug must not be used until a replacement cover is obtained.

A replacement fuse cover can be purchased from your local Panasonic dealer.

IF THE FITTED MOULDED PLUG IS UNSUITABLE FOR THE SOCKET OUTLET IN YOUR HOME THEN THE FUSE SHOULD BE REMOVED AND THE PLUG CUT OFF AND DISPOSED OF SAFELY.

THERE IS A DANGER OF SEVERE ELECTRICAL SHOCK IF THE CUT OFF PLUG IS INSERTED INTO ANY 13 AMP SOCKET.

If a new plug is to be fitted please observe the wiring code as shown below.

If in any doubt please consult a qualified electrician.

WARNING: THIS APPLIANCE MUST BE EARTHED.

IMPORTANT:

The wires in this mains lead are coloured in accordance with the following code:

Green-and-Yellow:	Earth
Blue:	Neutral
Brown:	Live

As the colours of the wire in the mains lead of this appliance may not correspond with the coloured markings identifying the terminals in your plug, proceed as follows.

The wire which is coloured GREEN-AND-YELLOW must be connected to the terminal in the plug which is marked with the letter E or by the Earth symbol \perp or coloured GREEN or GREEN-AND-YELLOW.

The wire which is coloured BLUE must be connected to the terminal in the plug which is marked with the letter N or coloured BLACK.

The wire which is coloured BROWN must be connected to the terminal in the plug which is marked with letter L or coloured RED.

How to replace the fuse: Open the fuse compartment with a screwdriver and replace the fuse (and fuse cover).

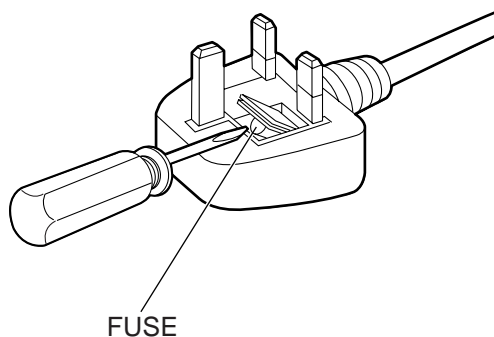
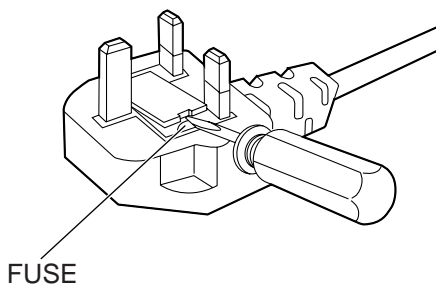

Condition of guarantee

This guarantee is in addition to and does not in any way affect any statutory or other rights of consumer purchasers. If within the applicable guarantee period, the appliance proves to be defective by reason of faulty design, workmanship or materials, we undertake subject to the following conditions to have the defective appliance (or any part or parts there of) repaired or replaced free of charge.

1. The appliance shall have been purchased and used solely within the UK and in accordance with standard operating instructions and the technical and/or Safety Standards required in the UK.
2. The purchaser will within 7 days of purchase complete the included warranty registration form (folded inside front cover) and fax it to us for registration. Failure to return such a form could result in delay in providing the guarantee service.
3. The appliance should be returned together with this guarantee and proof of date of purchase promptly on being found defective at the purchaser's risk and expense to the authorised dealer from whom the appliance was purchased or to the nearest authorised dealer. All enquiries must be through such dealers.
4. This guarantee shall not apply to damage caused through fire, accident, lightning, misuse, wear and tear, neglect, incorrect adjustment or repair, to damage caused through installation, adaption, modification or use in an improper manner or inconsistent with the technical and/or safety standards required in the country where this appliance is used, or to damage occurred during transit to or from the purchaser.
5. If at any time during the guarantee period any part or parts of the appliance are replaced with a part or parts not supplied or approved by us or of an objective quality safe and suitable for the appliance, or the appliance has been dismantled or repaired by any person not authorised by us, we shall have the right to terminate this guarantee in whole or in part immediately without further notice.
6. The purchaser's sole and exclusive remedy under this guarantee against us is for the repair or replacement of the appliance or any defective part or parts and no other remedy, including, but not limited to, incidental or consequential damage or loss of whatsoever nature shall be available to the purchaser.
7. This guarantee shall not apply to cassette tapes, batteries and any other items of limited nature life.
8. Our decision on all matters relating to complaints shall be final. Any appliance or defective part which has been replaced shall become our property.
9. The guarantee period applicable to this product shall be 12 months from the date of purchase.

Please keep these Operating Instructions with your receipt.

Panasonic Business Systems U.K.

Receipt No. _____	Date of Purchase _____
Model No. <u>KX-FP181E, KX-FP185E, KX-FM189E</u>	Serial No. _____

Index

- A** Accessories 6
- Advanced features 67–71
- Alert
 - (Memory reception)(Feature #44) .40, 69
 - (Message)(Feature #42) 68
 - (Recording time)(Feature #43) . . .69
- AUTO ANSWER mode 38, 39
- AUTO ANSWER setting (Feature #77) . .71
- Auto disconnection (Feature #49) . . .69

- B** Basic features 65, 66
- Broadcast programming list 85
- Broadcast sending report 37
- Broadcast transmission 34–37

- C** Call counter 56
- Caller ID list (Feature #26) . . .26, 67, 85
- Caller's recording time (Feature #10) .65
- Character table 15, 21
- Cleaning 82
- Collated copy 50
- Communication messages 72
- Connecting tone (Feature #76) 71
- Connections 12
- Copy 50, 51

- D** Date and time (Feature #01) . . . 13, 65
- Delayed transmission (Feature #25) . .67
- DIGITAL SP-PHONE button18, 29
- Directory feature 20
- Display
 - (Contrast)(Feature #39) 68
 - (Error messages) 73, 74
- Document feeder 82
- Document jam 81
- Document size 31, 86

- E** EASY DIAL
 - (Making a voice call) 23
 - (Selecting characters) 21
 - (Sending faxes) 30
 - (Storing) 20–22
- ECM selection (Feature #68) 70
- Enlarge copy 50, 51
- Error messages 72–74
- Extension telephone 45, 47

- F** Facsimile telephone number
 - (Feature #03) 16, 65
- Fax activation code (Feature #41) . . .68
- Fax auto redial 31
- FAX ONLY mode 38, 41
- FAX ONLY ring count
 - (Feature #06) 65
- Fax pager (Feature #70) 71
- Fax voice guidance (Feature #47) . . .69
- Fax voice guide 33
- Feature programming 64–71
- Feeder pressure 81
- Film 6, 83, 84
- Friendly reception (Feature #46) . .40, 69

- G** Greeting message
 - (Message transfer) (Feature #61) .63
 - (TAD/FAX) 53–55
 - (TEL/FAX) 44, 45, 54

- H** HELP button 7
- Hyphen button 20, 21

- I** Incoming message monitor
 - (Feature #67) 70
- Ink film 6, 83, 84
- Insert button 14, 15

- J** Jams 80, 81
- Journal report (Feature #22) .32, 67, 85

- L** List / Report
 - (Broadcast programming) 85
 - (Broadcast sending) 37
 - (Caller ID) 26, 67, 85
 - (Journal) 32, 67, 85
 - (Power down) 79
 - (Printer test) 85
 - (Sending) 32, 65
 - (Setup) 85
 - (Telephone number) 85
- Logo (Feature #02) 14, 65

- M** Melody ring (Feature #71) 71
- Memory reception alert
 - (Feature #44) 40, 69
- Memory transmission 33
- Message alert (Feature #42) 68
- Message transfer (Feature #60) . . .70
- MONITOR button 18
- Mute 18

- O** Overseas transmission mode
 (Feature #23)67
- P** Pager call (Feature #70)71
 Paper jam80
 PAUSE button19
 Power down report79
 Power failure79
 Power supply12, 86
 Printer test list85
 Printing paper size86
 Printing reports85
 Problem solving75–79
 Programmable features64–71
- Q** QUICK SCAN button33, 50
- R** RECALL button19
 Receiving
 (Fax)40
 (Setting)38, 39
 Receiving alert (Feature #44)69
 Receiving reduction (Feature #36)68
 Recording
 (Greeting message)54
 (Memo message)58
 (Telephone conversation)58
 Recording paper11, 86
 Recording paper jam80
 Recording time alert (Feature #43)69
 Recording time for TAD/FAX greeting
 message (Feature #54)69
 Redial18, 31
 Reduce copy50, 51
 Remote activation ID (Feature #12)66
 Remote operation card59, 60
 Remote operation ID (Feature #11)66
 Replacement film6, 83, 84
 Reset (Feature #80)71
 Resolution30
 Ring count
 (FAX ONLY) (Feature #06)65
 (Silent fax recognition) (Feature #30) .45, 67
 (TAD/FAX) (Feature #06)52, 65
 (TEL/FAX) (Feature #78)45, 71
 Ringer volume17
- S** Sending report (Feature #04)32, 65
 Set default (Feature #80)71
 Setup list85
- Silent fax recognition ring
 (Feature #30)45, 67
 Specifications86
 Storing
 (Broadcast)35, 36
 (Caller information)27
 (EASY DIAL)20–22
- T** TAD/FAX mode38, 52
 TAD/FAX ring count (Feature #06) . . .52, 65
 TEL mode39, 40
 TEL/FAX delayed ring count
 (Feature #78)71
 TEL/FAX mode39, 44, 45
 Telephone number list85
 Thermal head cleaning82
 Toll saver52, 65
 Transmission
 (Broadcast)34–37
 (EASY DIAL)30
 (From memory)33
 (Manually)30
 Transmittable document31
- V** Voice call
 (Answering)18
 (EASY DIAL)23
 (Making)18
 Voice contact29
 Volume17

National Panasonic

Kyushu Matsushita Electric Co., Ltd.
1-62, 4-chome, Minoshima, Hakata-ku, Fukuoka 812, Japan
Phone: Fukuoka (092) 431-2111
Telex: 725579KMEFUK J Cable Address: KMEFUKUKA/FUKUOKA

D00-KM7-0020-1-02

003770

Declaration of Conformity

We, Kyushu Matsushita Electric Co., Ltd., Telecom Division
of Matsushita Electric Industrial Co., Ltd.
Minoshima, Fukuoka, Japan

declare under our sole responsibility that the product
Facsimile Machine
Model No.: KK-FP181E
Trade Name: Panasonic

to which this declaration relates is in conformity with the following
standard(s) or other normative document(s)
CTR21, 1-CTR37, CTR38, EN55022(1998), EN55024(1998),
EN61000-3-2(1995)/A1(1998)/A2(1998), EN61000-3-3(1995), and
EN60950(1992)/A1(1993)/A2(1993)/A3(1993)/A4(1993)/A1(1997)

following the provisions of EC Council Directive(s)
1999/5/EC

Issued on: 28th May, 2000
Signed by the manufacturer:
(Signature): [Signature]
(Printed name): Katsuhiko Tawara
(Title): Director

Signed by authorized representative in the EU/EEA:
(Date): 18 Mar 2000
(signature): [Signature]
(Printed Name): Mitsuru Ishi
(Company Name): Panasonic Testing Centre (Europe) GmbH
(Address): 22525 Hamburg, F.R.G. Germany

National Panasonic

Kyushu Matsushita Electric Co., Ltd.
1-62, 4-chome, Minoshima, Hakata-ku, Fukuoka 812, Japan
Phone: Fukuoka (092) 431-2111
Telex: 725579KMEFUK J Cable Address: KMEFUKUKA/FUKUOKA

D00-KM7-0021-1-02

003927

Declaration of Conformity

We, Kyushu Matsushita Electric Co., Ltd., Telecom Division
of Matsushita Electric Industrial Co., Ltd.
Minoshima, Fukuoka, Japan

declare under our sole responsibility that the product
Facsimile Machine
Model No.: KK-FP181E
Trade Name: Panasonic

to which this declaration relates is in conformity with the following
standard(s) or other normative document(s)
CTR21, 1-CTR37, CTR38, EN55022(1998), EN55024(1998),
EN61000-3-2(1995)/A1(1998)/A2(1998), EN61000-3-3(1995), and
EN60950(1992)/A1(1993)/A2(1993)/A3(1993)/A4(1993)/A1(1997)

following the provisions of EC Council Directive(s)
1999/5/EC

Issued on: 12th June, 2000
Signed by the manufacturer:
(Signature): [Signature]
(Printed name): Katsuhiko Tawara
(Title): Director

Signed by authorized representative in the EU/EEA:
(Date): 20 Juni 2000
(signature): [Signature]
(Printed Name): Mitsuru Ishi
(Company Name): Panasonic Testing Centre (Europe) GmbH
(Address): 22525 Hamburg, F.R.G. Germany

National Panasonic

Kyushu Matsushita Electric Co., Ltd.
1-62, 4-chome, Minoshima, Hakata-ku, Fukuoka 812, Japan
Phone: Fukuoka (092) 431-2111
Telex: 725579KMEFUK J Cable Address: KMEFUKUKA/FUKUOKA

D00-KM7-0021-1-16

004357

Declaration of Conformity

We, Kyushu Matsushita Electric Co., Ltd., Telecom Division
of Matsushita Electric Industrial Co., Ltd.
Minoshima, Fukuoka, Japan

declare under our sole responsibility that the product
Facsimile Machine
Model No.: KK-FM139E
Trade Name: Panasonic

to which this declaration relates is in conformity with the following
standard(s) or other normative document(s)
CTR21, 1-CTR37, CTR38, EN55022(1998), EN55024(1998),
EN61000-3-2(1995)/A1(1998)/A2(1998), EN61000-3-3(1995), and
EN60950(1992)/A1(1993)/A2(1993)/A3(1993)/A4(1993)/A1(1997)

following the provisions of EC Council Directive(s)
1999/5/EC

Issued on: 2nd October, 2000
Signed by the manufacturer:
(Signature): [Signature]
(Printed name): Katsuhiko Tawara
(Title): Director

Signed by authorized representative in the EU/EEA:
(Date): 06 Oct 2000
(signature): [Signature]
(Printed Name): Mitsuru Ishi
(Company Name): Panasonic Testing Centre (Europe) GmbH
(Address): 22525 Hamburg, F.R.G. Germany

CE 0682

Kyushu Matsushita Electric Co., Ltd.

1-62, 4-chome, Minoshima, Hakata-ku, Fukuoka 812-8531, Japan

PFQX1520ZA WH1000NK0

Free Manuals Download Website

<http://myh66.com>

<http://usermanuals.us>

<http://www.somanuals.com>

<http://www.4manuals.cc>

<http://www.manual-lib.com>

<http://www.404manual.com>

<http://www.luxmanual.com>

<http://aubethermostatmanual.com>

Golf course search by state

<http://golfingnear.com>

Email search by domain

<http://emailbydomain.com>

Auto manuals search

<http://auto.somanuals.com>

TV manuals search

<http://tv.somanuals.com>