

# Panasonic

INTEGRATED TELEPHONE SYSTEM

EASA-PHONE®

Pulse-or-tone dialing capability

MODEL NO. **KX-T3281W**

**INTERCOM 2 LINE**

## Operating Instructions

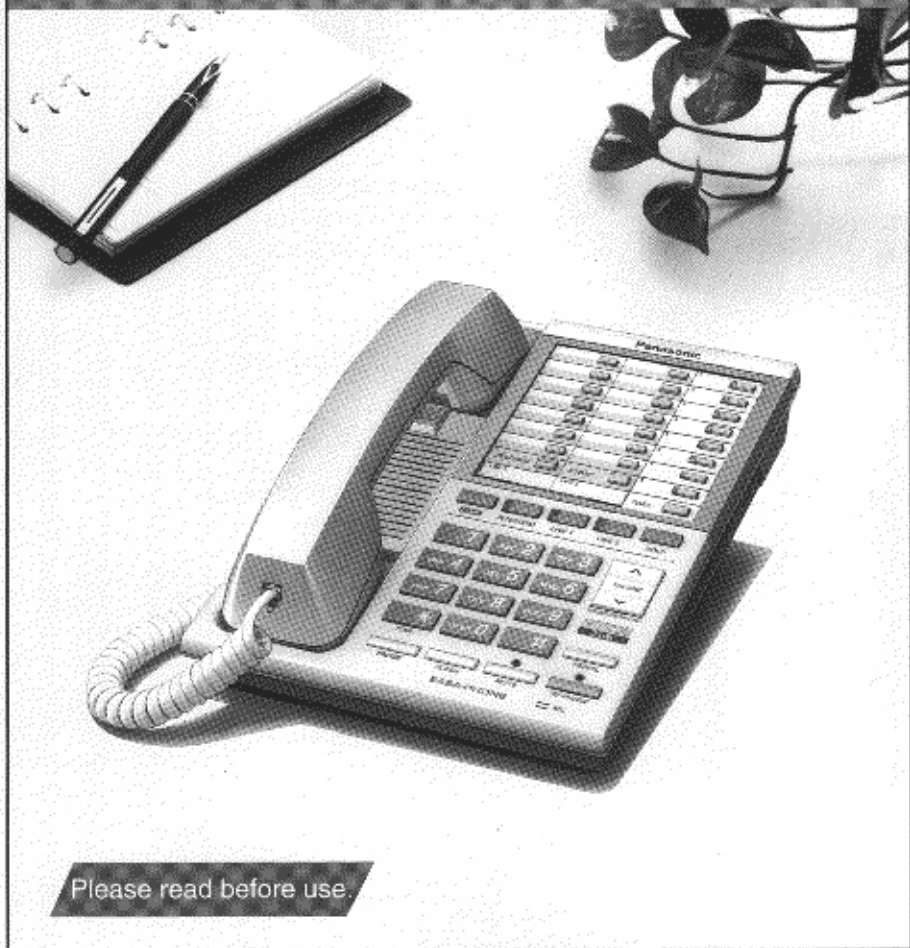

Please read before use.

Please read **IMPORTANT SAFETY INSTRUCTIONS** on pages 41 and 42 before use. Read and understand all instructions.

## Introduction (Features)

### **Thank you for purchasing the KX-T3281W.**

The KX-T3281W is an excellent integrated telephone system, which can utilize two telephone lines (two telephone numbers) and an intercom line. You can use the following convenient features:

#### **When you make a call:**

- Selecting the telephone line automatically (Auto line selection)(p. 36)
- Redialing the last dialed number (p. 17)
- Dialing a stored phone number from memory (p. 23)

#### **During a conversation:**

- Talking with a caller through the speakerphone (Hands-free operation) (p. 16)
- Adjusting the volume of the caller's voice (pp. 15,17)
- Using the other line while keeping the current call (p. 28)
- Having a conference call using other telephone lines (p. 30)

#### **Intercom call use:**

- Conversing between extension users (p. 24)
- Transferring an outside call to another extension (p. 27)

## Accessories (For accessory order, call toll free 1-800-332-5368.)

Handset (p. 7)

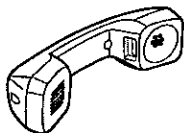

one

Handset cord (p. 7)



one

AC adaptor (p. 7)

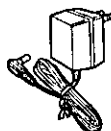

one

4-wired telephone line cord with green plugs (pp. 8-10)

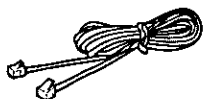

one

2-wired telephone line cord with transparent plugs (pp. 8-10)

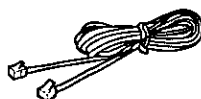

one

# Contents

---

Location of controls .....	4
Indicator lights and status .....	6
Connections .....	7
Preparation .....	11
<b>Making calls</b> .....	14
Making calls with the handset .....	15
Making calls with the speakerphone .....	16
<b>Answering calls</b> .....	18
<b>Automatic dialing</b> .....	19
Storing phone numbers into memory .....	19
Dialing a stored number from memory .....	23
(Full one-touch dialing)	
<b>Intercom call</b> .....	24
Making an intercom call .....	24
Answering an intercom call directed to another extension .....	25
Paging to all extensions .....	26
Transferring an outside call to another extension .....	27
<b>Using the other line during a conversation</b> .....	28
Making-(receiving) an outside call with one line on hold .....	28
Making an intercom call with one line on hold .....	29
<b>Conference</b> .....	30
<b>Toll restriction</b> .....	32
<b>Other features</b> .....	34
Temporary tone dialing .....	34
PAUSE button (For PBX users) .....	34
MUTE button .....	34
FLASH button (To use the hookswitch feature) .....	35
Using the call waiting feature .....	35
HOLD button .....	35
<b>Station programming</b> .....	36
Automatic line selection .....	36
Assigning extension numbers .....	37
Intercom alerting type setting .....	38
Incoming call tone programming .....	39
"Extension privacy" feature .....	40
<b>Important safety instructions</b> .....	41
<b>FCC and other information</b> .....	43
<b>Troubleshooting guide</b> .....	45
<b>Wall mounting</b> .....	46

# Location of controls

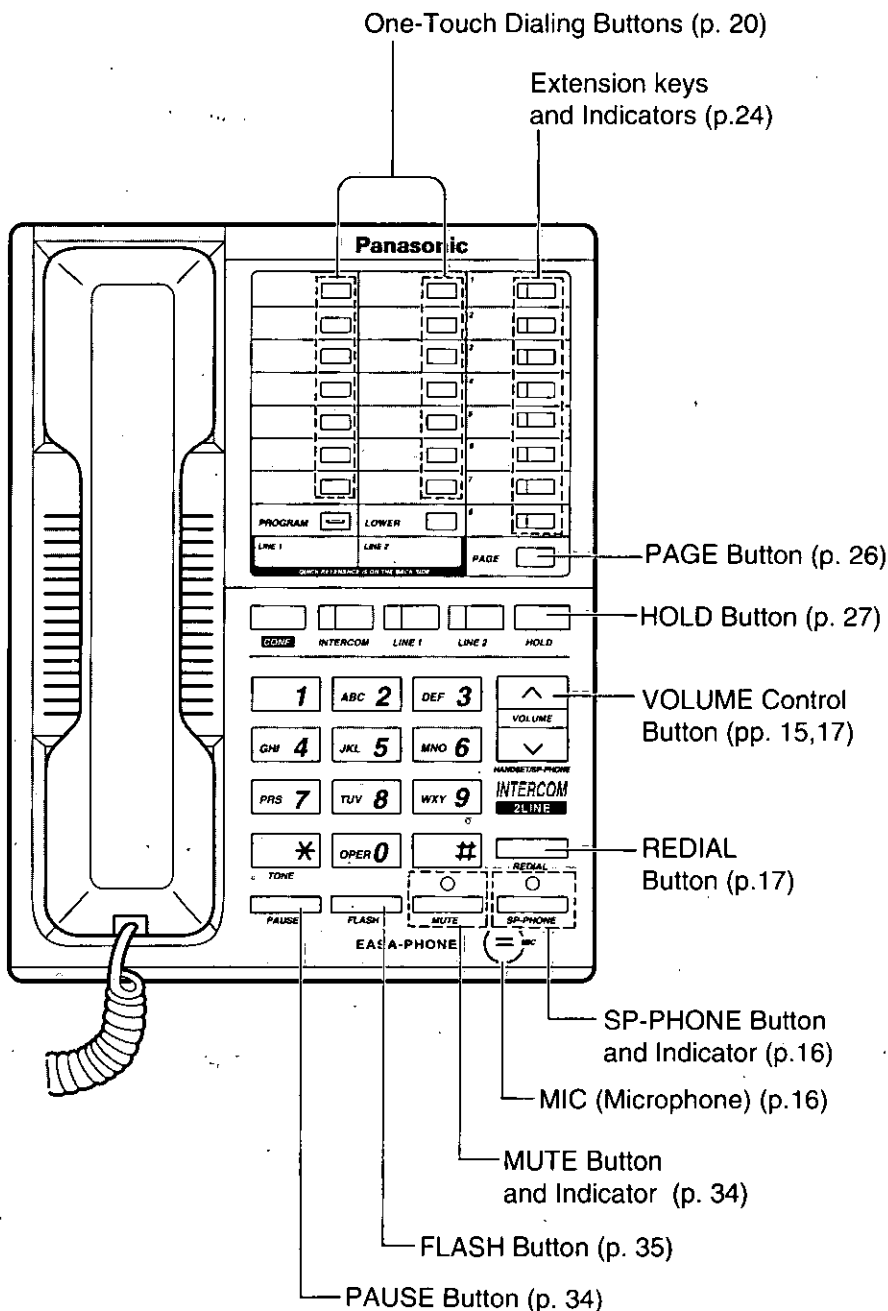

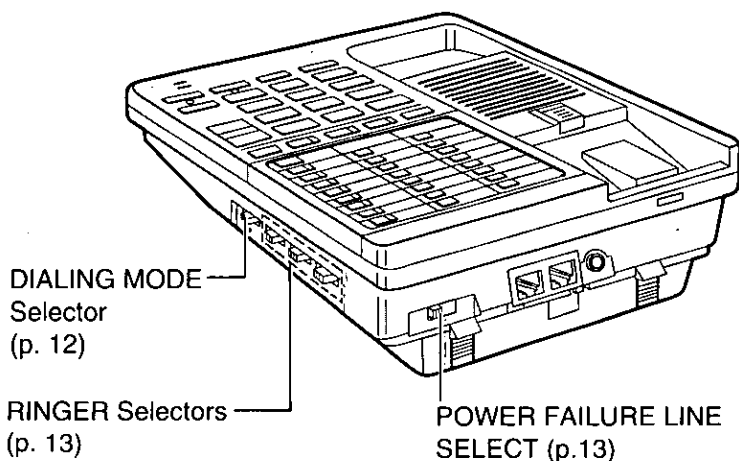
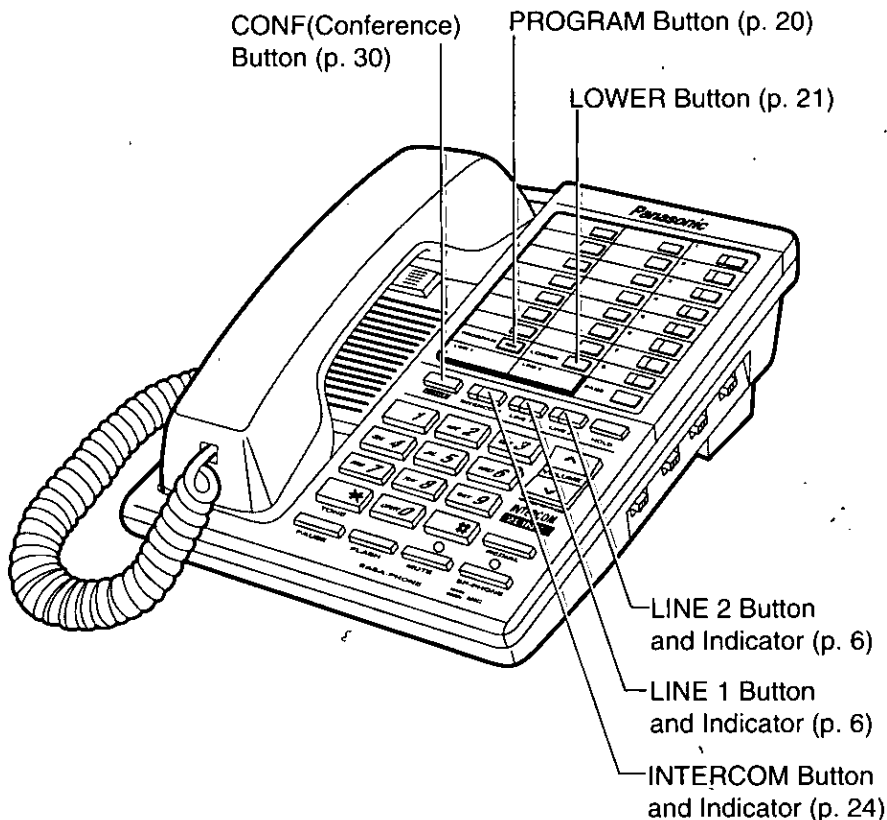

# Indicator lights and status

Each line indicator works as listed below:

Intercom Indicator	
Off	Intercom is free
On (Green)	Your extension is in use
Flashing slowly (green)	An intercom call is on hold at your extension
Flashing quickly (green)	An intercom call is incoming
On (red)	Intercom is in use at other extension

Line Indicators	
Off	Line is free
On (Green)	Your telephone is in use on outside line
Flashing slowly (green)	Call is on hold at your extension
On (red)	Another extension is in use on outside line
Flashing slowly (red)	Call is on hold at another telephone
Flashing quickly (red)	Call is incoming

Extension Indicators	
Off	Extension is free
On (red)	<ul style="list-style-type: none"> <li>• Your extension is in use or call is on hold</li> <li>• Another extension is in use or on hold</li> </ul>

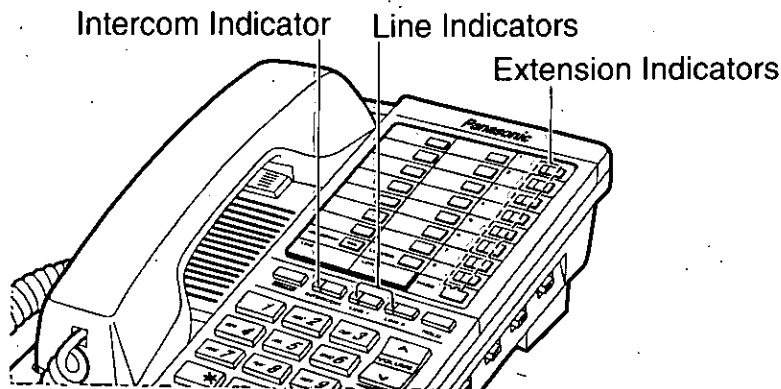

# Connections

## Connecting the AC adaptor and the handset

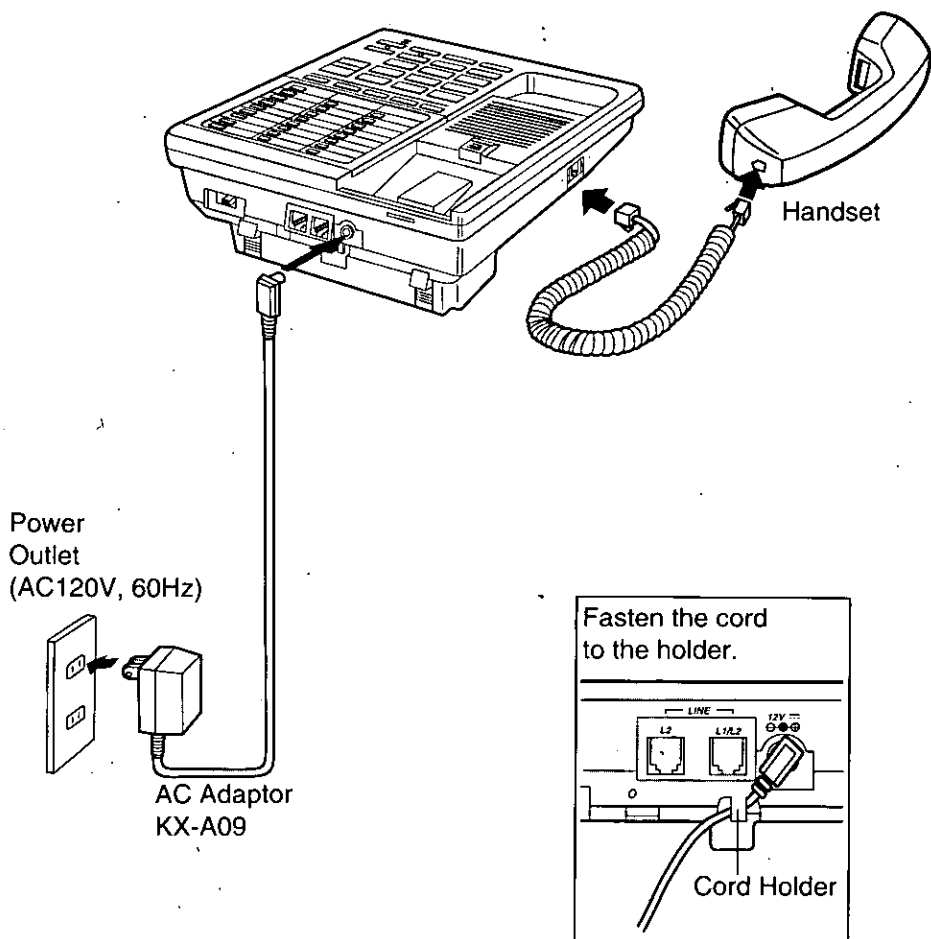

### Note:

- USE ONLY a Panasonic Handset for KX-T3281W and Panasonic AC ADAPTOR KX-A09.
- During a power failure, the unit will function only as a single-line telephone.
- The AC adaptor must remain connected on each unit.

# Connecting to telephone line jacks

You can connect maximum of eight KX-T3281W telephones in parallel.

## To connect to two-line telephone jacks

-To use the Intercom, you must connect the telephone line cord to the unit's telephone line jack "L1/L2".

Parallel Connected Two-Line Telephone  
Telephone Line Jack Jack

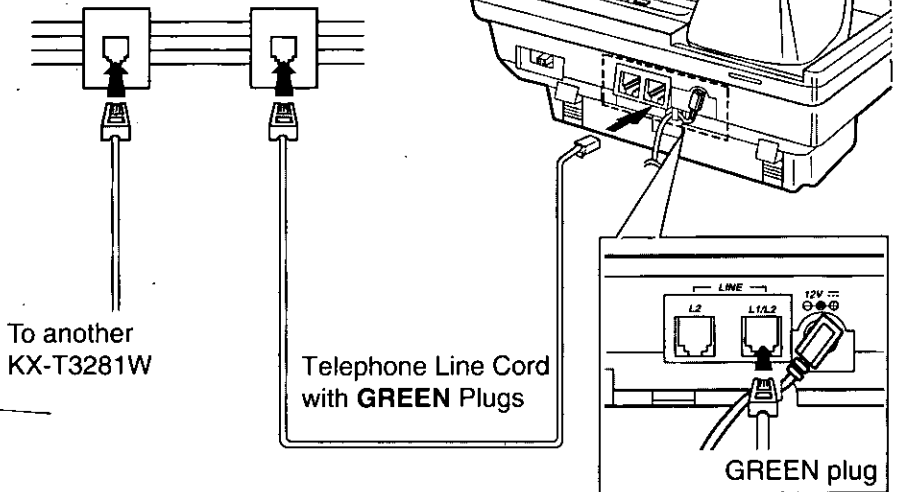
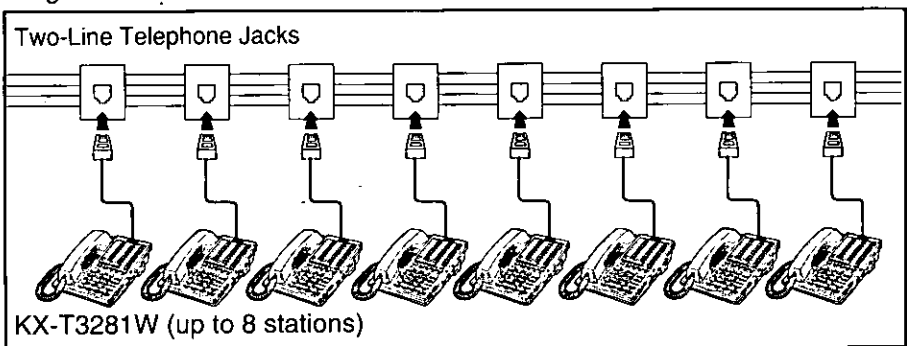

Diagram:



- If another model Telephone is connected to the KX-T3281W, the KX-T3281Ws' line indicators do not convey its line usage.
- If you connect a KX-T2180 and a KX-T3281W (2-line telephone) on the same line, connect the KX-T2180 to the L1/L2 jack of the KX-T3281W.



# Alternative to having individual two-line telephone jacks

Use the optional Panasonic T-adaptor KX-J66, and continue to wire to all the KX-T3281W telephones:

## To connect to a two-line telephone jack

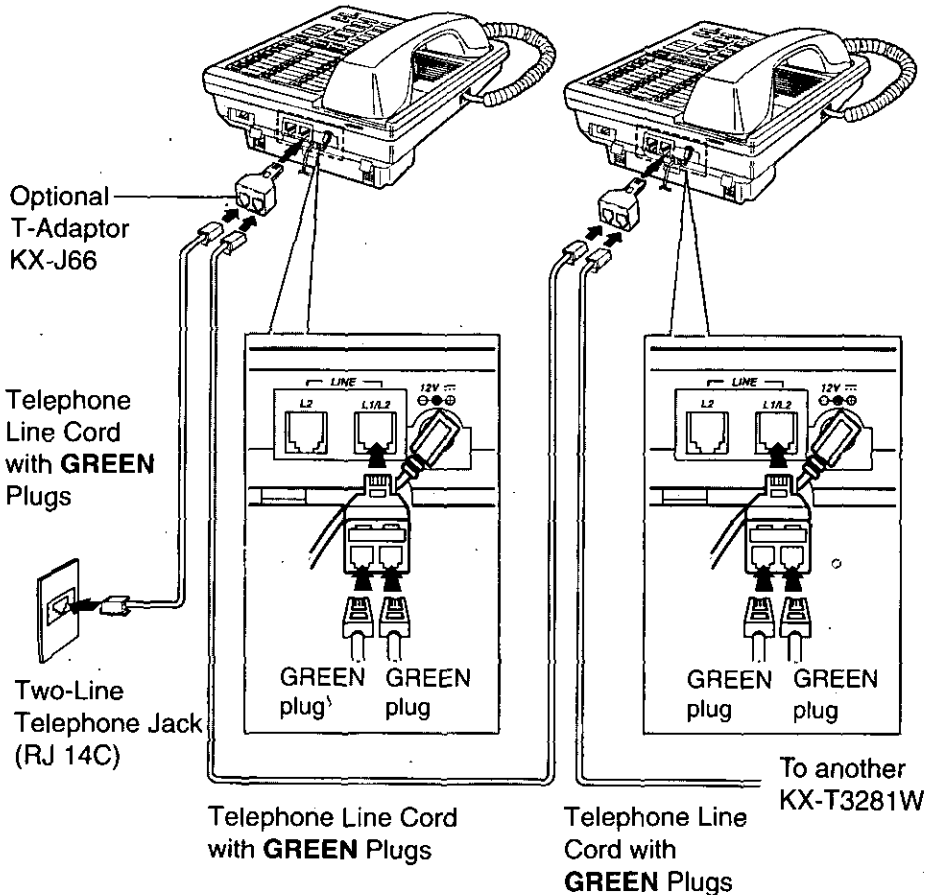

### Note:

- Confirm that all extension lights flash when you plug in the AC adaptor before connection to the telephone line. If the extension lights do not flash, clear the previously stored extension number by pressing the PROGRAM and then the PAGE buttons. After connecting the telephone to the telephone line jack, assign the extension number to the unit (see page 37).

# To connect to two single-line telephone jacks

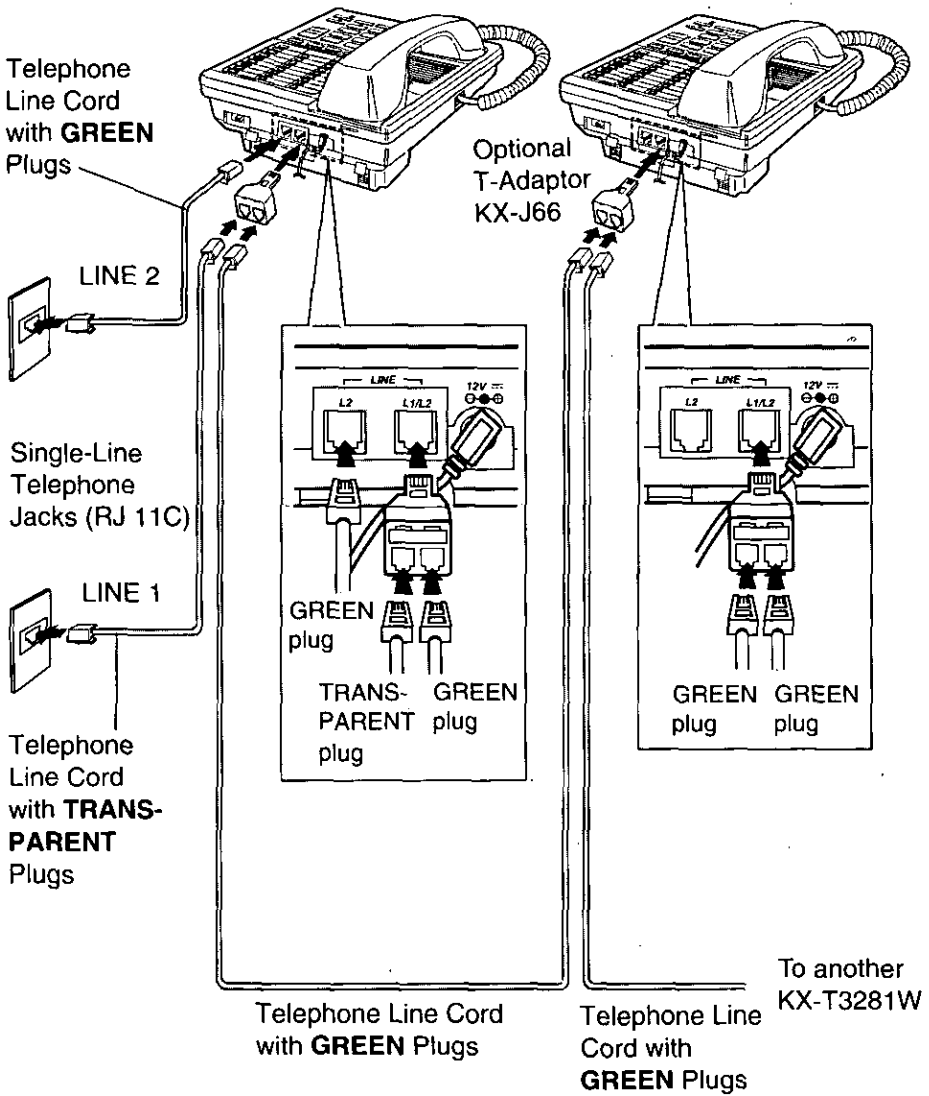

# Preparation

## Station programming

The following programming must be done on each extension.

Program	Initial setting	Page
<b>Automatic line selection</b> The programmed telephone line is selected automatically when you lift the handset.	AUTO (Selects the free line automatically.)	36
<b>Extension number assignment</b> Each extension must be assigned an extension number. To assign: press <b>PROGRAM</b> → <b>EXT (1-8)</b>	Not assigned.	37
<b>Intercom alerting type setting</b> Select Bell, Voice, Answer Back or Room Monitor to alert an extension of an intercom call.	Bell	38
<b>Toll restriction</b> Restricts long distance dialing.	No restriction	32
<b>Incoming call tone programming</b> During a conversation, the incoming call tone alerts you that an intercom or outside call is arriving. You can set the tone to ON or OFF by programming.	Off	39
<b>"Extension privacy" feature</b> Allows you to prevent other extensions from joining in your conversation with an outside party. You can set the feature "OFF" to allow other extensions to access the call.	On	40

### Answer Back and Room Monitor:

When set to these, an extension can answer an intercom call through the speakerphone without pressing any keys.

# Setting selectors

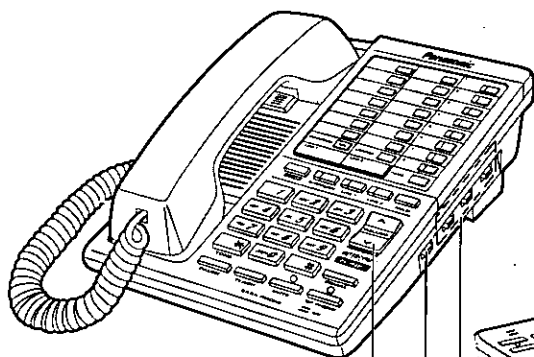

- ① VOLUME Control Button
- ② DIALING MODE Selector
- ③ RINGER Selectors

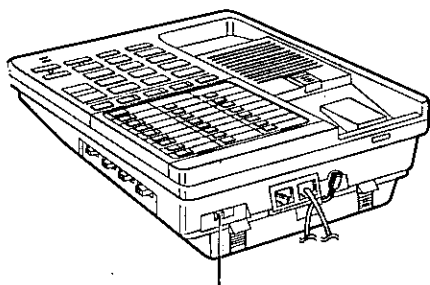

- ④ POWER FAILURE LINE SELECT

## ① VOLUME Control Button:

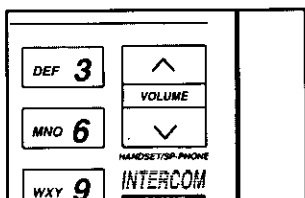

You can change the volume of the caller's voice through the handset receiver or the speakerphone.

## ② DIALING MODE Selector:

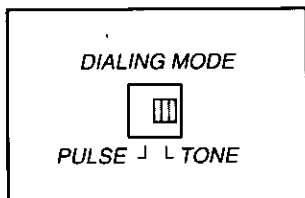

Set to the TONE position when both telephone lines have touch tone service. If either line has rotary service, set to the PULSE position.

### ③ RINGER Selectors: (LINE 1, LINE 2, INTERCOM)

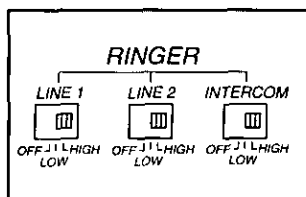

Use to set the ringer volume of each line. Set to the HIGH or the LOW position.

When setting to the OFF position, the bell will not ring for that line.

When another call is arriving during a conversation, the bell does not ring. You can make two beeps sound every fifteen seconds to alert the call by programming (see page 39).

### ④ POWER FAILURE LINE SELECT:

During a power failure, this unit operates as a single-line telephone. Set to the line (L1 or L2) you wish to use during a power failure.

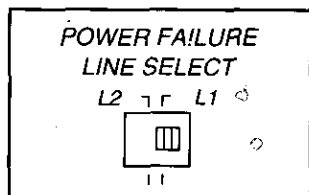

- Calls made to the line not selected will not ring.
- The Hold, Intercom, Paging, Conference and SP-PHONE functions will not work.
- The LINE Indicator will not light.
- The RINGER Selectors will not function.

- Set less than five telephones to the same line position if more than five units are connected in parallel. Or bell might not ring.

# Making calls

The unit automatically selects a free line when you lift the handset (or press the SP-PHONE button), since the "AUTO" setting is programmed initially from the "Automatic line selection" feature. If you want to change the mode, see page 36.

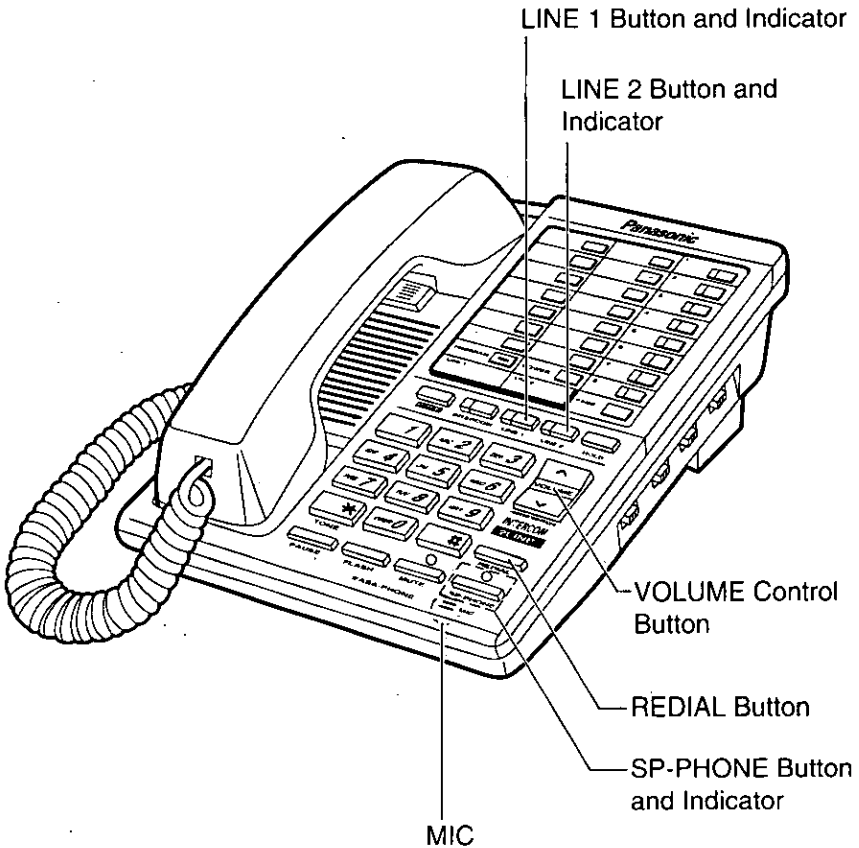

**Note:**

- You can make or answer a second call on the other line while keeping the present call on hold (see page 28).
- An extension user who shares the same line can not join in another party's conversation. Although, each extension user can program to allow other extensions to join in the conversation (see page 40).

# Making calls with the handset

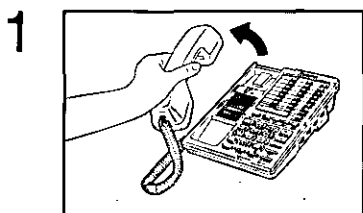

Lift the handset.

- The unit selects a free line, and the line indicator lights green.

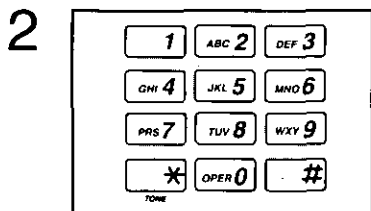

Dial the phone number.



Speak to the other party.

- To change to speakerphone operation, press the SP-PHONE button. You may replace the handset in the cradle.

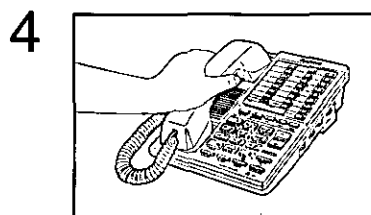

When you have finished, place the handset in the cradle.

- The line indicator light goes out.

## To adjust the handset receiver's volume

You can adjust the volume level of the handset receiver using the VOLUME control button during a conversation.

3 levels are available (**High**, **Rather high** and **Normal**).

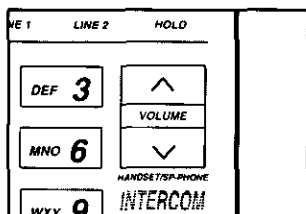

To increase the volume, press  $\wedge$ .  
To decrease the volume, press  $\vee$ .

Three beeps sound at the high or the normal level.

After hanging up, the selected volume level is maintained.

# Making calls with the speakerphone

1

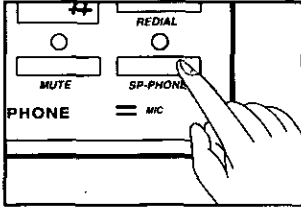

Press the SP-PHONE button.

- The unit selects a free line and the line indicator lights green and the SP-PHONE indicator light is on.

2

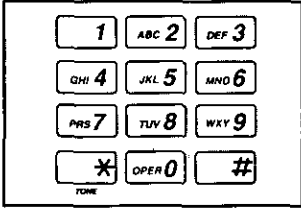

Dial the phone number.

3

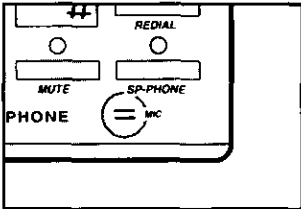

Speak to the other party through the MIC (Microphone).

- To switch to a handset call, lift the handset.

4

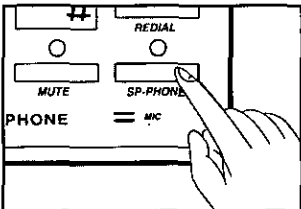

When you have finished, press the SP-PHONE button.

- The SP-PHONE indicator and the line indicator lights go out.

## Note:

- You might want to select the LINE 2 (LINE 1) when lifting the handset, in this case set the "Auto line selection" to the "LINE 2" (LINE 1) mode (see page 36).
- You can dial manually regardless of the "Auto line selection" feature, in this case follow the steps below.

**When using the handset:** Lift the handset then press the LINE button.

**When using the SP-PHONE:** Press the LINE button directly (the SP-PHONE turns on automatically).



- For helpful hints for speakerphone operation, see page 17.

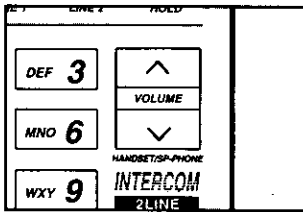

## To adjust the speaker volume

You can adjust the volume of the speaker using the VOLUME control button during a conversation. 12 levels are available.



To increase the volume, press .  
To decrease the volume, press .

Three beeps sound at the maximum or the minimum level.

After hanging up, the selected volume level is maintained.

## Helpful hints for the speakerphone operations:

- Use the speakerphone in a quiet room for best performance.
- If the other party has difficulty hearing you, decrease the volume.
- If you and the other party speak at the same time, parts of your conversation will be lost. To avoid this, speak alternately.

## If you misdial

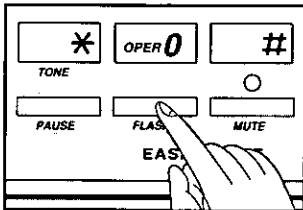

Press the FLASH button firmly.  
When you hear a dial tone, dial the correct number.

## To redial

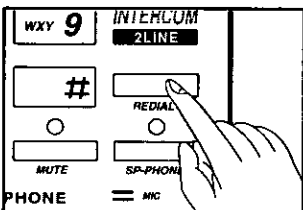

Press the REDIAL button.  
The unit redials the last dialed number once.

## Note:

- Be sure that LINE 1 or LINE 2 is selected before pressing the REDIAL button.

# Answering calls

When an incoming call is arriving, the LINE indicator light flashes red quickly.

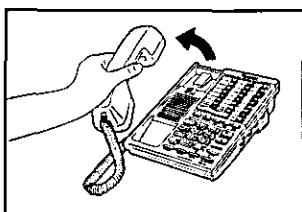

Lift the handset or press the SP-PHONE button to answer the call.

- The unit automatically selects the line with the incoming call and the line indicator changes to a steady green light.

OR

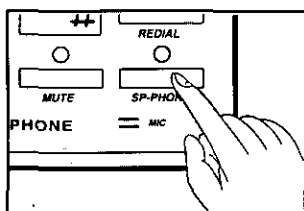

When you have finished, replace the handset or press the SP-PHONE button.

## Note:

- If the "AUTO" is selected from the "Automatic line selection" feature the unit selects the incoming line automatically when you lift the handset. If the "LINE 1" or "LINE 2" or "INTERCOM" is selected, press the Incoming line's button after lifting the handset or pressing the SP-PHONE button.
- If the RINGER selector is in the OFF position, the bell will not ring. Set it to the HIGH or LOW position for bell tone.

# Automatic dialing

---

The unit can store up to 28 phone numbers you often dial into memory (14 numbers in the upper memory stations, 14 numbers in the lower memory stations).

The stored number is dialed automatically by pressing one of the one-touch dialing buttons.

## Storing phone numbers into memory

Each memory station can store a phone number up to 16 digits.

Be sure that the handset is in the cradle, the AC adaptor is connected and the SP-PHONE indicator light is out.

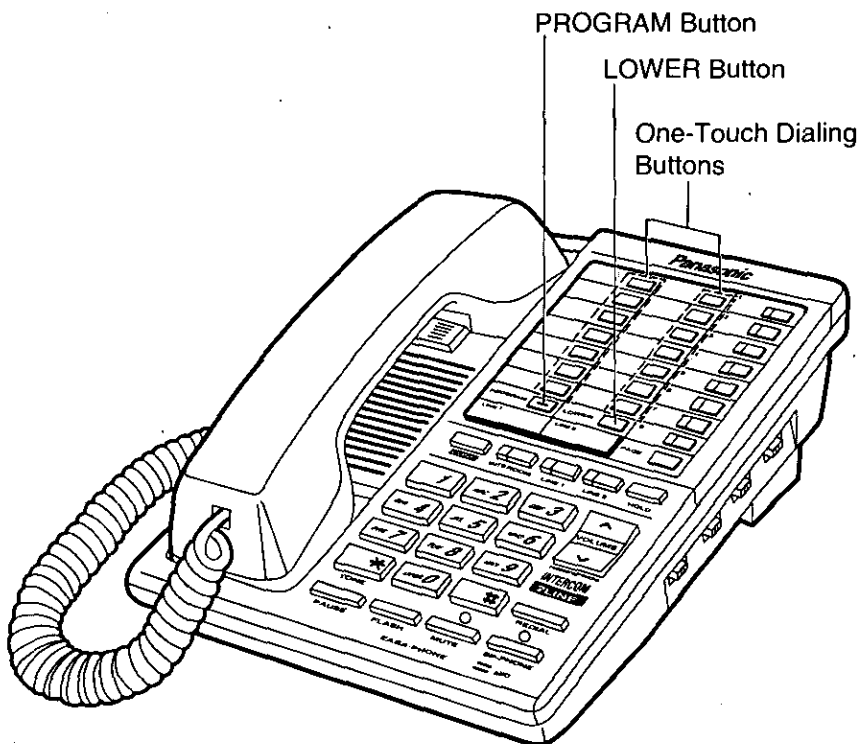

## Using UPPER memory stations

1

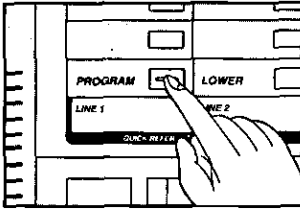

Press the PROGRAM button.

– The MUTE indicator light is on.

2

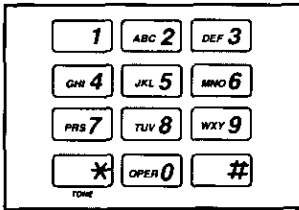

Enter a phone number to 16 digits.

3

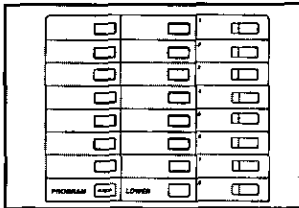

Press one of the one-touch dialing buttons to select the memory station.

– A beep sounds when the phone number is stored.

**OR**

Two beeps sound if the same number is already stored.

– To store other numbers, repeat steps 1 through 3.

### Note:

- If you misdial, press the PROGRAM button to end programming. Start from step 1 to store the correct number.
- A "PAUSE", a "FLASH", a "\*" or a "#" can be stored with a phone number counting as one extra digit.
- If the AC adaptor is disconnected for more than 30 minutes the stored numbers may be erased. Confirm the number before trying to dial them.

## Using LOWER memory stations

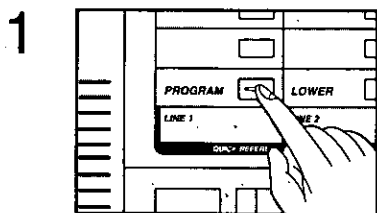

- Press the PROGRAM button.
- The MUTE indicator light is on.

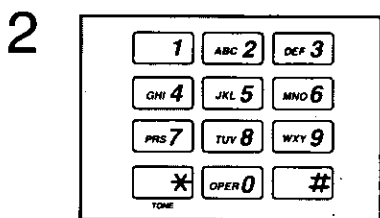

- Enter a phone number to 16 digits.

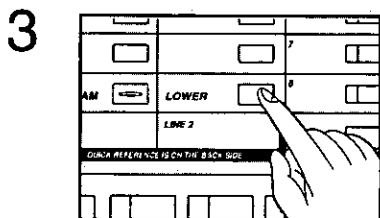

- Press the LOWER button.
- The MUTE indicator begins flashing.

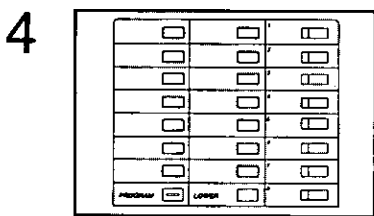

- Press one of the one-touch dialing buttons to select the memory station.
- A beep sounds when the number is stored.
- OR**
- Two beeps sound if the same number is already stored.
- To store other numbers, repeat steps 1 through 4.

### Note:

- If you misdial, press the PROGRAM button to end programming. Start from step 1 to store the correct number.

## To confirm a stored number

Store the phone number which you want to confirm into the same memory station. You will hear one or two beeps.

### **Two beeps sound and the MUTE indicator flashes once:**

The newly stored number is the same as the previously stored one.

### **One beep sounds and the MUTE indicator light goes out:**

The newly stored number is different from the previously stored one.

## To erase a stored number

1. Press the PROGRAM button.
2. If the number is located in the UPPER memory stations:  
press the one-touch dialing button for the number to be erased.

**OR**

If the number is located in the LOWER memory stations:  
press the LOWER button, then the one-touch dialing button.

## Memory card

Remove the memory card and write down the names or phone numbers associated with automatic dialing stations.

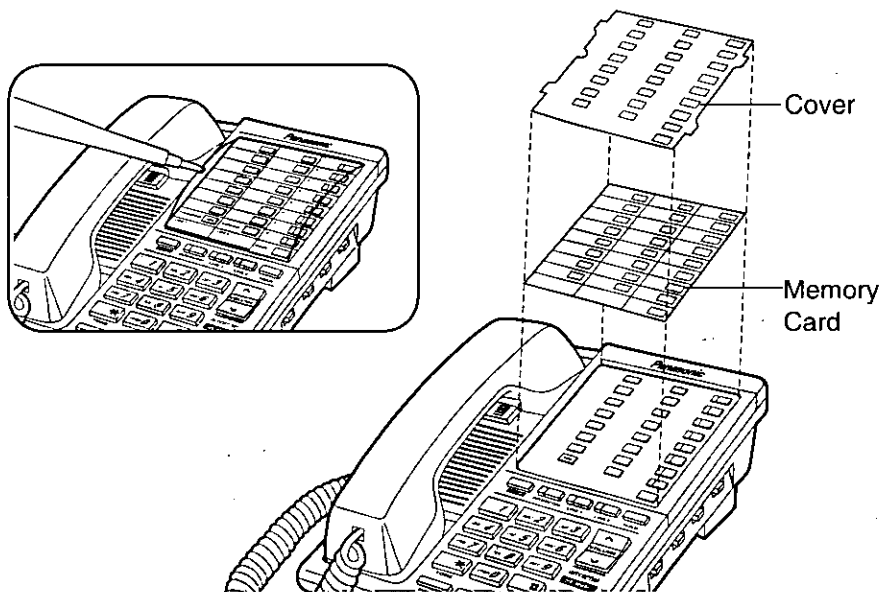

# Dialing a stored number from memory

(Full one-touch dialing)

1

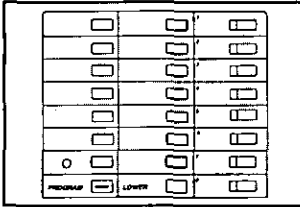

**Using the UPPER memory stations:**  
Press the one-touch dialing button where the phone number is stored.

- The SP-PHONE turns on automatically and the stored number is dialed.

OR

OR

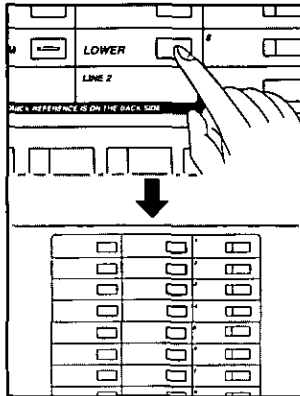

**Using the LOWER memory stations:**  
Press the LOWER button.

- The SP-PHONE turns on automatically.

Then, press the one-touch dialing button where the phone number is stored.

- The stored number is dialed.

2

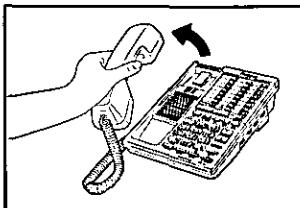

Lift the handset to switch to a handset call.

- If you wish to continue with a speakerphone call, you need not lift the handset. Speak through the MIC.

## Note:

- The unit selects the line automatically from the "Automatic line selection" feature.

# Intercom call

Use the intercom to talk to someone at another extension.  
Be sure that a number is assigned to each extension.

## Making an intercom call

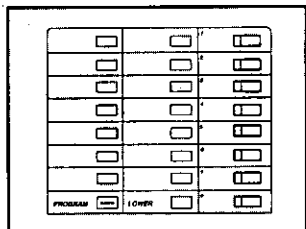

Press the extension key (EXT1-EXT8) of the extension you want to reach.

- The SP-PHONE and the INTERCOM turn on automatically.
- If the INTERCOM line is busy, you will hear a busy tone and you will not be able to make an intercom call.

### Note:

- When you press the extension key to make an intercom call, you hear different types of tones corresponding to the called extension's programmed mode of the "Intercom alerting type setting".  
If **Bell** is set, you hear a long beep.  
If **Voice**, **Answer Back** or **Room Monitor** is set, speak to the extension after two confirming tones.

## To answer an intercom call

When you hear an intercom alert (Bell or Voice), lift the handset or press the SP-PHONE button.

Program the "Answer Back or Room Monitor" mode from the "Intercom alerting type setting" feature to answer the call through the speakerphone without pressing any keys (see page 38).

### Note:

- When an incoming call arrives while in a conversation on the intercom line, two tones are heard.



# Answering an intercom call directed to another extension

This feature allows you to answer an intercom call sent to another extension. The INTERCOM indicator lights red.

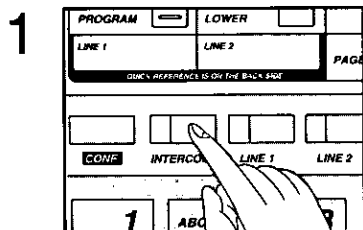

Press the INTERCOM button.

- The SP-PHONE turns on automatically and you hear a busy tone.
- To change to a handset call, lift the handset.

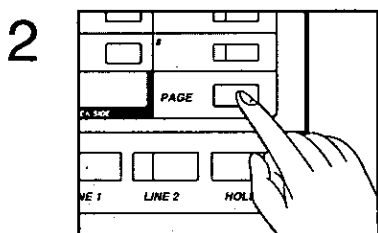

Press the PAGE button.

## Note:

- If the called extension set the "Intercom alerting type setting" to the **Answer Back** or **Room Monitor** mode, you can not answer the call.

# Paging to all extensions

You can page to all extensions simultaneously.

## To page

Be sure that the INTERCOM indicator is not lit red.

1

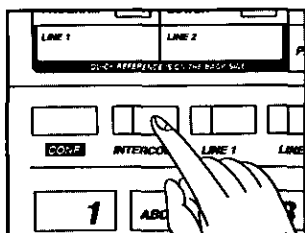

Press the INTERCOM button.

- You hear a dial tone. If the INTERCOM line is in use, you will hear a busy tone and will not be able to page.

2

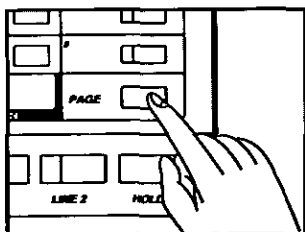

Press the PAGE button, and make an announcement through the MIC after two confirming tones.

- You can talk to an extension once they've picked up the handset or pressed the SP-PHONE button.

### Note:

- During a call, you can page to all extensions putting the call on hold (pressing the HOLD button) and pressing the PAGE button.

## To answer the paging

Once you hear the announcement, lift the handset (or press the SP-PHONE button, or press the INTERCOM button) and talk.

While using the intercom, the INTERCOM indicator will remain green.

# Transferring an outside call to another extension

You can use the intercom even during a call. This allows you to transfer the call to another extension.

## To transfer after the other extension answers

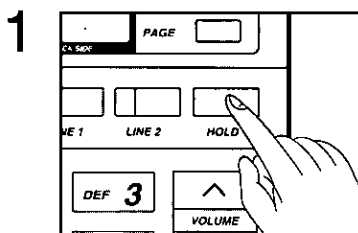

Press the HOLD button to place the outside call on hold.

- The line indicator changes from a steady green light to a flashing one.
- The INTERCOM turns on automatically and the indicator lights green.

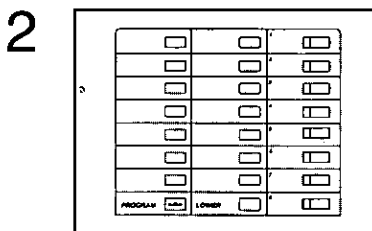

Press an extension key (EXT 1-EXT 8) to page another extension user.

- Wait for an answer. Tell the extension you are transferring a call.

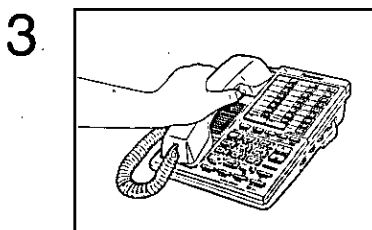

Replace the handset or press the SP-PHONE button.

- The unit transfers the call.

## To transfer without announcing to the other extension

1. Press the HOLD button.
  2. Press the extension key (EXT 1-EXT 8).
  3. Replace the handset or press the SP-PHONE button to transfer the call.
- The line indicator of the transferred extension begins flashing red.

### Note:

- Press the HOLD button first. Pressing the INTERCOM button before pressing the HOLD button terminates the outside call.
- If the called extension party does not answer the page, press the LINE button to return to the outside call.

# Using the other line during a conversation

While having a conversation on one line, if the other line indicator begins flashing, an incoming call is arriving on the line.

You can answer the second call while keeping the first call. Making a call without ending the first call is also possible.

## Making (receiving) an outside call with one line on hold

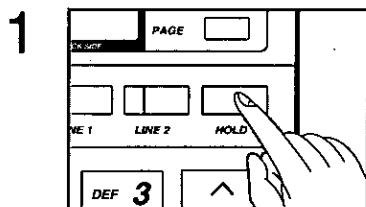

**Example: If you are using LINE 1.**

Press the HOLD button to put the LINE 1 call on hold.

- The LINE 1 indicator changes from a steady green light to a flashing one.
- The INTERCOM turns on automatically, and the indicator lights green.

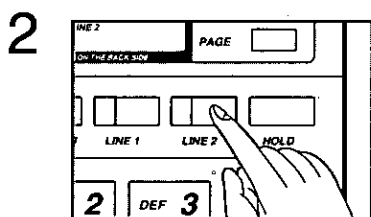

Press LINE 2 to make or answer a second call.

- The LINE 2 indicator lights green.

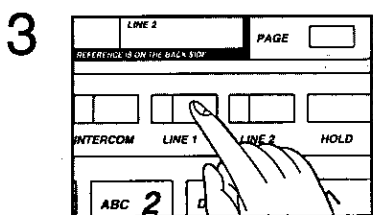

To return to the first call (LINE1), press the LINE button of the first call (LINE 1).

- The LINE 1 indicator light changes to green, terminating the other call.
- To keep the second call, press the HOLD button, then press the INTERCOM button.

### Notes:

- **To cancel a HOLD from another extension:**

Lift the handset and press the LINE button, or press the LINE button whose indicator light (red) is flashing.

- When an outside call is arriving during an intercom conversation, the bell does not ring. To set the incoming call tone, see page 39 for programming. Two tones sound every 15 seconds to alert you of the call.

# Making an intercom call with one line on hold

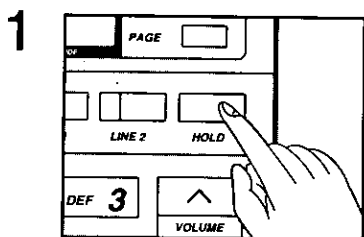

**Example: If you are using LINE 1.**  
Press the HOLD button to put the LINE 1 call on hold.

- The LINE 1 indicator changes from a steady green light to a flashing one.
- The INTERCOM turns on automatically, and the indicator lights green.

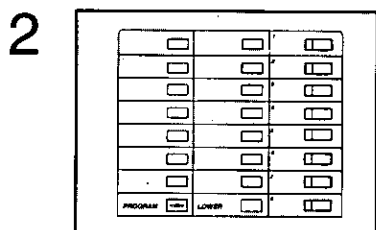

Press an extension key (1-8) to make an intercom call.

- The extension indicator lights red.

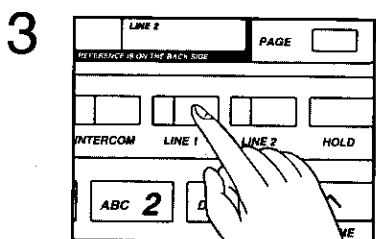

To return to the first call (LINE 1), press the LINE button of the first call (LINE1).

- The LINE 1 indicator light changes to green and the intercom call terminates.
- To keep the intercom call, press the HOLD button, then press the LINE button.

## Answering an intercom call with the one line on hold

When the INTERCOM indicator flashes green quickly, an intercom call is arriving.

1. Example: If you are using LINE 1.

Press the HOLD button to put the LINE 1 call on hold.

2. Press the INTERCOM button and then answer the page.

- According to the intercom alert pattern, the answering procedure is different (see page 24). You need not press the INTERCOM button in the Answer Back or the Room Monitor mode.

### Note:

- When an intercom call is arriving while having a conversation on the outside line, the bell does not ring. To set the incoming call tone, see page 39 for programming. Two tones sound every 15 seconds to alert you of the call.

# Conference

While having a conversation on one line, you can make or answer a second call on the other line, then combine both lines together to create a conference call.

## With two outside parties

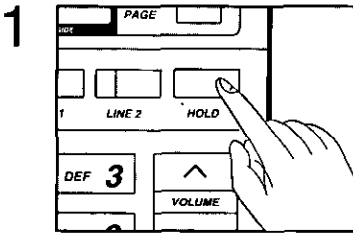

**Example: If you are using LINE 1:**  
Press the HOLD button to put the first call (LINE 1) on hold.

– The INTERCOM turns on automatically, and the indicator lights green.

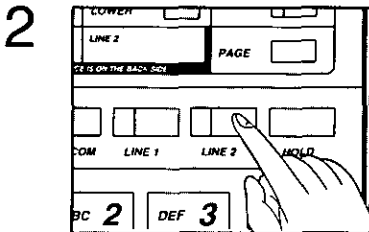

Press the other line button (LINE 2) to make or answer a second call.

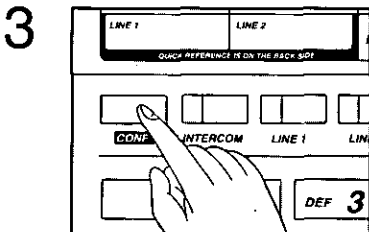

When the second call is connected, press the CONF(Conference) button to combine the lines to create a conference call.

## To hang up both lines:

Place the handset in the cradle or press the SP-PHONE button.

## To continue with one of the calls:

Press the LINE 1(or 2) button of the call you want to continue.

## With an outside party and an inside party

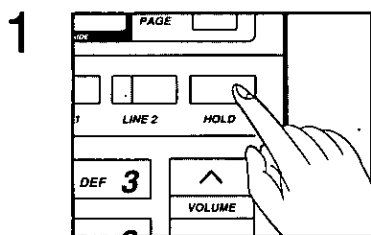

**Example: If you are using LINE 1:**  
Press the HOLD button to put the first call (LINE 1) on hold.

– The INTERCOM turns on automatically and the indicator lights green.

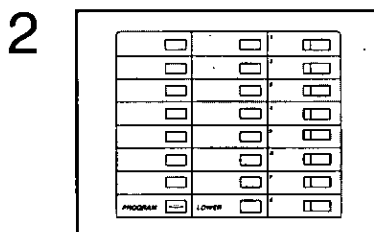

Press an extension key (EXT1- EXT8) to make an intercom call.

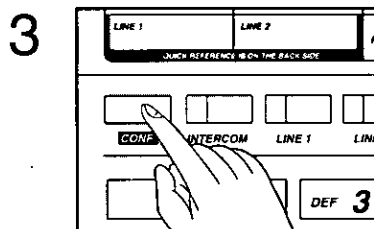

Press the CONF(Conference) button to create a conference call.

### To hang up both lines:

Place the handset in the cradle or press the SP-PHONE button.

### To continue with the outside call:

Press the LINE 1 button to talk with the other party.  
The intercom call terminates.

### To continue with the extension:

Press the INTERCOM button.  
The outside call terminates.

# Toll restriction

Use this feature to allow you to restrict long distance calls. Even when programmed in this mode, you can dial local call numbers. You can also store a 3-digit area code up to five numbers to allow long distance calls to selected areas.

In this mode:

## Local call

(the first digit can not be 1 or 0).....Dialing is possible

## Long distance call

(the first digit is 1 or 0)

If a 2nd-4th digit is **800** or your programmed area code number.....Dialing is possible

Except the above numbers.....Dialing is impossible

## To set to toll restriction mode

1

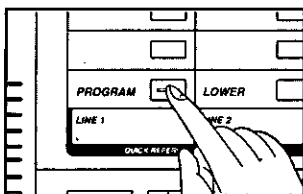

Press the PROGRAM button.

- The MUTE indicator light is on.

2

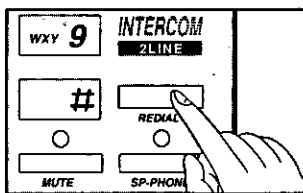

Press the REDIAL button.

- The MUTE indicator light goes out.

3

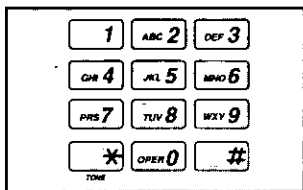

Dial "3 2".

## To set to no toll restriction mode

1. Press the PROGRAM button.

2. Press the REDIAL button.

3. Dial "3 1".

- The stored area code numbers will not be erased by removing the toll restriction.



## To store area code numbers

1

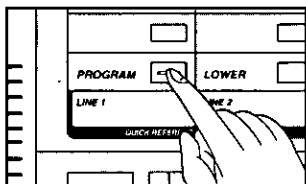

Press the PROGRAM button.

– The MUTE indicator light is on.

2

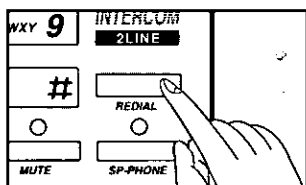

Press the REDIAL button.

– The MUTE indicator light goes out.

3

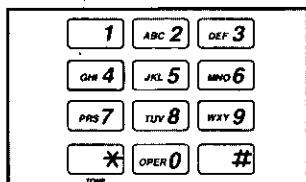

Dial "4".

4

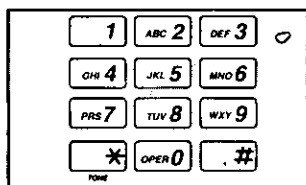

Enter a 3-digit area code number.

– To store other numbers, repeat from steps 1 through 4.

– Phone numbers with that area code can be dialed.

– "\*" is used to store dialing numbers of "0-9".

**For example:** To store the code numbers of "400-499", enter "4\*\*".

Any phone number with an area code containing 4 as a first digit can be dialed.

### Note:

– If you hear 6 beeps when you have entered a number, it indicates five area code numbers are already stored, and no others can be stored.

– Local calls with one as the first digit can not be dialed with TOLL RESTRICTION, turn the TOLL RESTRICTION off to dial the number.

## To cancel the stored area code numbers

1. Press the PROGRAM button.

2. Press the REDIAL button.

3. Dial "4 #".

– All the stored area code numbers will be erased.

# Other features

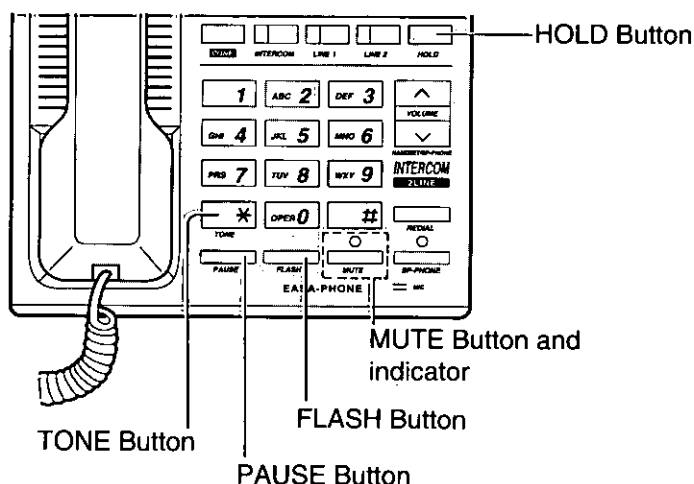

## Temporary tone dialing

If your line has rotary service, pressing the TONE (\*) button allows you to change the dialing mode temporarily into tone.

Then you can dial the numbers or codes needed to operate the answering system or to use electronic banking services and other special services.

When you hang up, the dialing mode returns to pulse automatically.

## PAUSE button (For PBX users)

If your unit is connected to a PBX, you need to dial an access number (usually 9) to get an outside line. In this case, inserting a pause between the access number and the phone number is necessary, especially when redialing or storing a number into memory.

Press the PAUSE button to insert a pause in the dialing sequence.

## MUTE button

The MUTE button allows you to mute your voice. You can hear the other party, but the other party cannot hear you.

Press the MUTE button.

The MUTE indicator light is on.

To resume the conversation, press the MUTE button again.

The MUTE indicator light goes out.

## FLASH button (To use the hookswitch feature)

The FLASH button works the same as the hookswitch on a regular phone. If you misdial or dial another phone number, press the FLASH button firmly. The call is terminated and the dial tone is heard, then you can dial the next phone number.

If your unit is connected to a PBX, pressing the FLASH button lightly allows you to use special features of the PBX such as transferring an extension call.

## Using the call waiting feature

To use this feature, you are required to subscribe to a call waiting service offered by your local telephone company.

1. While having a conversation, another party calls and you hear a tone.
2. Press the FLASH button lightly.

The first call is put on hold and you can answer the second call. To return to the first call, press the FLASH button again. The second call is put on hold.

## HOLD button

Press the HOLD button during a conversation to put the call on hold.

### To release a HOLD

#### When the handset is OFF-hook:

- Outside line: Press the LINE 1 or (LINE 2) button.
- Intercom line: Press the INTERCOM button.

#### When the handset is ON-hook:

- Outside line: Lift the handset then press the LINE 1 or (LINE 2) button, or press the LINE 1 or (LINE 2) button (Speakerphone).
- Intercom line: Lift the handset then press the INTERCOM button or press the INTERCOM button (Speakerphone).

When pressing the HOLD button to put the outside call on hold, the intercom automatically turns ON.

You can program automatic INTERCOM activation to be either ON or OFF to set the intercom.

“ON” .... Press **PROGRAM** → **REDIAL** → **#** → **1**

“OFF” .... Press **PROGRAM** → **REDIAL** → **#** → **2**

# Station programming

Program each extension separately.

Be sure that the handset is in the cradle, the AC adaptor is connected and the SP-PHONE indicator light is out.

## Automatic line selection

This feature allows you to select the telephone line automatically when you lift the handset or press the SP-PHONE button.

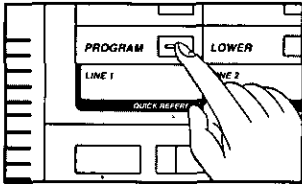
- 

Press the PROGRAM button.

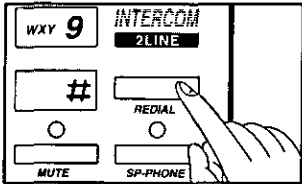
–The MUTE indicator light is on.
- 

Press the REDIAL button.

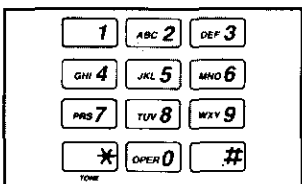
–The MUTE indicator light goes out.
- 

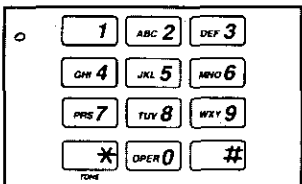
Dial "1".
- 

Enter "1", "2", "3", or "4" on the dialing keypads.

  - .....LINE 1 will be selected.
  - .....LINE 2 will be selected.
  - .....INTERCOM will be selected.
  - .....AUTO (A free line will be selected and the LINE 1-has the priority.)

– A beep sounds and the unit stores your selection.

### Note:

– You can confirm whether the entry is the same as the previously stored one in each station programming.

**Two beeps:** The new entry is the same as the previously stored entry:

**One beep:** The new entry is different from the previously stored entry.

# Assigning extension numbers

Assign each extension a number for intercom calls.

- 1 Press the PROGRAM button.  
– The MUTE indicator light is on.

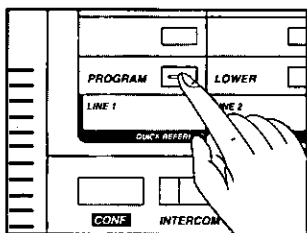

- 2 Press one of the extension keys (EXT1-EXT8).  
– A beep sounds and the number is stored.

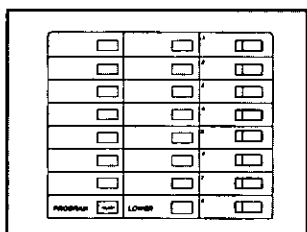

## Note:

- 6 beeps sound if you previously assigned the number to an extension.  
Change the number following steps 1 and 2.

## To cancel a stored extension number

- 1 Press the PROGRAM button.

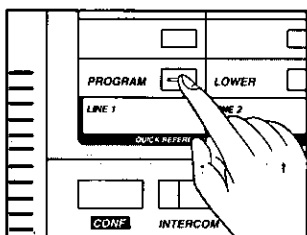

- 2 Press the PAGE button.  
– All extension lights flash until a new extension number is assigned.

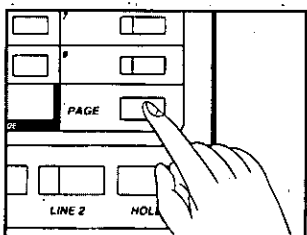

# Intercom alerting type setting

The mode (Bell/Voice/Answer Back/Room Monitor) used to alert an extension of an intercom call can be programmed.

**Bell:** A bell alerts the extension.

**Voice:** The caller's voice alerts the extension.

**Answer Back:** Two short beeps alert the extension, then the unit automatically turns on the speakerphone and the intercom and you can answer the call.

**Room Monitor:** Nothing alerts the extension but the speakerphone and the intercom turn on automatically. The paging party can monitor the extension's room without alerting.

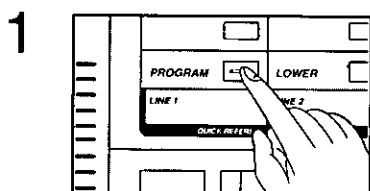

Press the PROGRAM button.

– The MUTE indicator light is on.

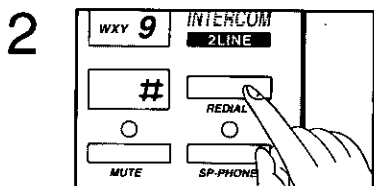

Press the REDIAL button.

– The MUTE indicator light goes out.

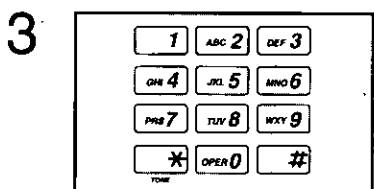

Dial "2".

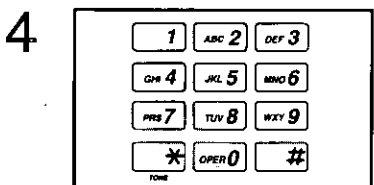

Enter "1", "2", "3" or "4".

- 1.....Bell alerting
- 2.....Voice alerting
- 3.....Answer Back
- 4.....Room Monitor

# Incoming call tone programming

Incoming call tone alerts you that an intercom or an outside call is arriving. Two tones sound every 15 seconds when another call is arriving during a conversation. You can set the tone by programming. Program each extension individually. The initial setting is OFF.

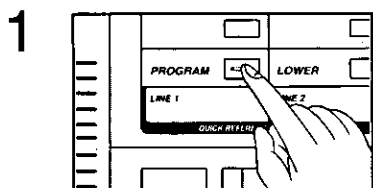

Press the PROGRAM button.

– The MUTE indicator light is on.

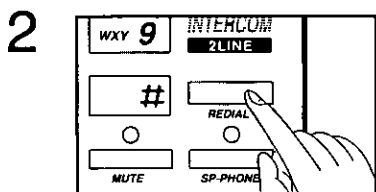

Press the REDIAL button.

– The MUTE indicator light goes out.

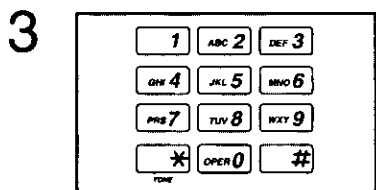

Dial "0".

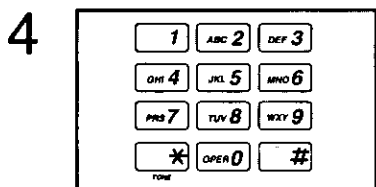

Dial "1" or "2".

1.....ON

2.....OFF

## Note:

– When the LINE RINGER or the INTERCOM RINGER selector is in the OFF position, the incoming call tone will not sound for that line.

## “Extension privacy” feature

The feature allows you to prevent other extensions from joining in your conversation with an outside party. You can set the feature “OFF” to allow other extensions to access the call. The initial setting is “ON”.

### To program

1. Press the PROGRAM button.
2. Press the REDIAL button.
3. Dial “9”.
4. Dial “1” or “2”.
  - 1.....ON (No access)
  - 2.....OFF (Access)

### To join a conversation from other extensions

When your extension is set to “OFF”, other extensions can join your conversation with an outside party by pressing their LINE button which is lit.

#### Notes:

- The intercom feature may not work when more than three extensions join another extension’s conversation.
- An extension cannot join a conversation between the other extensions and an outside party unless all the conversing extensions have set the feature “OFF”.

### Full one-touch dialing

This feature enables the speakerphone to turn on automatically by pressing one of the one-touch dialing buttons or extension keys.

You can program this feature “ON” or “OFF”. If set to “OFF”, you must first lift the handset or press either the SP-PHONE, LINE or INTERCOM button before pressing one-touch dialing or extension buttons.

1. Press the PROGRAM button.
2. Press the REDIAL button.
3. Press the MUTE button.
4. Dial “1” or “2”.
  - 1.....ON
  - 2.....OFF



# Important safety instructions —

When using this unit, basic safety precautions as below should always be followed to reduce the risk of fire, electric shock, or personal injury.

1. Read and understand all instructions.
2. Follow all warnings and instructions marked on this unit.
3. Unplug this unit from wall outlets before cleaning. Do not use liquid or aerosol cleaners. Use a damp cloth for cleaning.
4. Do not use this unit near water, for example, near a bath tub, wash bowl, kitchen sink, or the like.
5. Install this unit securely on a stable surface. Serious damage may result if the unit falls.
6. Do not cover slots and openings of the unit, for they are provided for ventilation and protection against overheating. Never place the unit near radiators, in/or a place where proper ventilation is not provided.
7. Use only the power source as marked on the unit. If you are not sure of the type of the power supply to your home, consult your dealer or local power company.
8. Do not place objects on the power cord. Install the unit where no one can step on the cord.
9. Do not overload wall outlets and extension cords as this can result in the risk of fire or electric shock.
10. Never push any objects into this unit through slots as they may result in risk of fire or electric shock. Never spill any liquid on the unit.
11. To reduce the risk of electric shock, do not disassemble this unit, but take it to a qualified serviceman when some service or repair work is required. Opening or removing covers may expose you to dangerous voltages or other risks. Incorrect reassembly can cause electric shock when the appliance is subsequently used.
12. Unplug this unit from the wall outlet and refer servicing to qualified service personnel under the following conditions:
  - A. When the power supply cord or plug is damaged or frayed.
  - B. If liquid has been spilled into the unit.
  - C. If the unit has been exposed to rain or water.

- D. If the unit does not work normally by following the operating instructions. Adjust only controls covered by the operating instructions, for improper adjustment may require extensive work by a qualified technician.
  - E. If the unit has been dropped or damaged.
  - F. If the unit exhibits a distinct change in performance.
13. During thunderstorms, avoid using telephones except cordless types. There may be a remote risk of electric shock from lightning.
14. Do not use this unit to report a gas leak in the vicinity of it.

## SAVE THESE INSTRUCTIONS

### **INSTALLATION:**

1. Never install telephone wiring during a lightning storm.
2. Never install telephone jacks in wet locations unless the jack is specifically designed for wet locations.
3. Never touch uninsulated telephone wires or terminals unless the telephone line has been disconnected at the network interface.
4. Use caution when installing or modifying telephone lines.

### **WARNING:**

TO PREVENT FIRE OR SHOCK HAZARD, DO NOT EXPOSE THIS PRODUCT TO RAIN OR ANY TYPE OF MOISTURE.

When programming emergency numbers and/or making test calls to emergency numbers:

- 1) Remain on the line and briefly explain to the dispatcher the reason for the call before hanging up.
- 2) Perform such activities in the off-peak hours, such as early morning hours or late evenings.

# FCC and other information

If requested by the telephone company, inform them as follows:

- FCC Registration No.  
(found on the bottom of the unit)
- Ringer Equivalence....0.2B  
Ringer Equivalence (Under a power failure)....1.0B
- The particular telephone lines to which the equipment is connected.

This unit must not be connected to a coin operated line. If you are on a party line, check with your local telephone company.

## **Ringer Equivalence No. (REN):**

The REN is useful in determining the quantity of devices you may connect to your telephone line and still have all of those devices ring when your telephone number is called. In most, but not all areas, the sum of the REN's of all devices connected to one line should not exceed five (5.0). To be certain of the number of devices you may connect to your line, as determined by the REN, you should contact your local telephone company to determine the maximum REN for your calling area.

In the event terminal equipment causes harm to the telephone network, the telephone company should notify the customer, if possible, that service may be stopped.

However, where prior notice is impractical, the company may temporarily cease service providing that they:

- a) Promptly notify the customer.
- b) Give the customer an opportunity to correct the problem with their equipment.
- c) Inform the customer of the right to bring a complaint to the Federal Communication Commission pursuant to procedures set out in FCC Rules and Regulations Subpart E of Part 68.

The telephone company may make changes in its communications facilities, equipment, operations or procedures, where such action is reasonably required in the operation of its business and is not inconsistent with the rules and regulations in FCC Part 68.

If such changes can be reasonably expected to render any customer terminal equipment incompatible with telephone company communications facilities, or require modification or alteration of such terminal equipment, or otherwise materially affect its use or performance, the customer shall be given adequate notice in writing, to allow the customer an opportunity to maintain uninterrupted service.

**CAUTION:**

Any unauthorized changes or modifications not expressly approved by the party responsible for compliance could void the user's authority to operate this device.

**Note:**

This equipment has been tested and found to comply with the limits for a Class B digital device, pursuant to Part 15 of the FCC Rules. These limits are designed to provide reasonable protection against harmful interference in a residential installation. This equipment generates, uses, and can radiate radio frequency energy and, if not installed and used in accordance with the instructions, may cause harmful interference to radio communications. However, there is no guarantee that interference will not occur in a particular installation. If this equipment does cause harmful interference to radio or television reception, which can be determined by turning the equipment off and on, the user is encouraged to try to correct the interference by one or more of the following measures:

- Reorient or relocate the receiving antenna.
- Increase the separation between the equipment and receiver.
- Connect the equipment into an outlet on a circuit different from that to which the receiver is connected.

- Consult the dealer or an experienced radio/TV technician for help.

**Note:**

- If there is any trouble, disconnect the unit from the telephone line and connect a known working phone. If the known working phone operates properly, have your unit repaired by one of the specified Panasonic Factory Service Centers. If the known working phone does not operate properly, consult with your telephone company.
- The unit should not be placed in room where the temperature is less than 5°C (41°F) or greater than 40°C (104°F).
- The unit should be situated so that the location or position does not interfere with its proper ventilation. Allow 10 cm. (4") clearance around the unit.
- When the unit is not used for long periods of time, the unit should be unplugged from the household AC outlet.
- Do not place heavy objects on top of this unit.
- Place the unit on a flat level surface, or use the wall mounting adaptor for wall installation. Damp basements should also be avoided.
- Do not subject this unit to excessive smoke, dust, mechanical vibration, shock, or direct sunlight.

# Troubleshooting guide ---

## **The unit does not ring.**

- The RINGER selectors are set to OFF position.  
Set to HIGH or LOW position (see page 13).
- Another call is proceeding on the other line.

## **The call cannot be connected even when dialed correctly.**

- Check whether the DIALING MODE selector setting is correct (see page 12).

## **The unit does not work.**

- The unit is connected improperly (see pages 7-10).
- The AC adaptor is not connected.

## **The unit cannot store phone numbers into memory.**

- The handset must be in the cradle and the SP-PHONE indicator light is out.
- Do not pause for over 60 seconds while storing.
- The AC adaptor must be connected.

## **While storing a phone number, the unit starts to ring.**

- Simply lift the handset to answer the call. You must begin programming from the start.

## **The SP-PHONE button cannot be used.**

## **Full one-touch dialing cannot be done.**

## **Automatic line selection does not function.**

## **The Intercom does not work.**

- Connect the AC adaptor.

## **The caller suddenly cannot hear my voice during a conversation.**

- If the MUTE indicator lights, press the MUTE button (see page 34).

## **You hear a busy tone when you have pressed the Intercom button.**

- The Intercom is being used.  
Wait until the line becomes free.

## **While having a conversation, the other line indicator flashes red.**

- An incoming call is arriving on the other line. To answer it, press the HOLD button to put the current call on hold, then press the line button whose indicator is flashing red. To return to the first call, press the line button of the first call (see page 28).

## **While operating the unit, the AC adaptor feels warm.**

- This is the normal operating condition.

# Wall mounting

This unit can be mounted on a wall phone plate. If you do not have one installed, consult your telephone company or an installer.

1

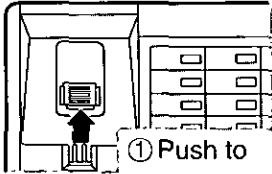

① Push to remove.

Remove the handset guide from the unit, then turn it over.

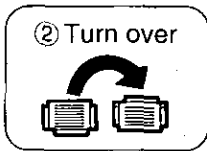

② Turn over

2

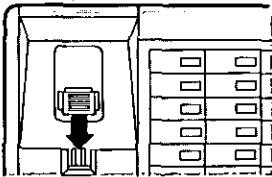

Replace the handset guide with its tab upward.

3

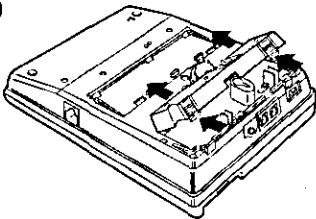

Remove the wall mounting adaptor from the bottom of the unit.

4

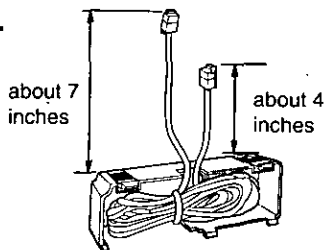

Tuck the telephone line cord inside the wall mounting adaptor.

5

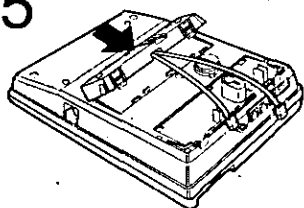

Insert the tabs of the wall mounting adaptor into the openings of the unit, then push it in the direction of the arrow. (The word "UP" on the adaptor should be upward.)

6

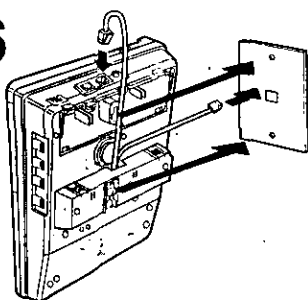

Connect the telephone line cord to the unit and to the wall-jack on the wall phone plate. Mount the unit on the wall phone plate, then seat securely by hooking as shown.

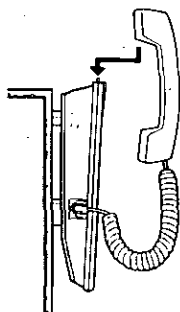

To temporarily place the handset down during a conversation, place as shown.

## **Panasonic Telephone Products Limited Warranty**

Panasonic Consumer Electronics Company or Panasonic Sales Company (collectively referred to as "the warrantor") will repair this product with new or refurbished parts, free of charge, in the U.S.A. or Puerto Rico for one (1) year from the date of original purchase in the event of a defect in material or workmanship.

Carry-in or mail-in service in the U.S.A. can be obtained during the warranty period from a Panasonic Services Company (PASC) Factory Servicenter. Please refer to the Servicenter Directory or call 1-800-545-2672, toll free, to locate an authorized PASC Servicenter and mail your product adequately packed and insured.

Carry-in or mail-in service in Puerto Rico can be obtained during the warranty period by calling the telephone numbers listed in the Servicenter Directory. This warranty is extended only to the original purchaser. A purchase receipt or other proof of date of original purchase will be required before warranty performance is rendered. This warranty only covers failures due to defects in materials and workmanship which occur during normal use. It does not cover damage which occurs in shipment or failures which are caused by products not supplied by the warrantor or failures which result from accident, misuse, abuse, neglect, mishandling, misapplication, alteration, modification, lightning, line power surge, introduction of sand, dust, humidity and liquids or commercial use of the product, or service by anyone other than a PASC Factory Servicenter or authorized PASC Servicenter, or damage that is attributable to acts of God.

### **Limits and Exclusions**

There are no express warranties except as listed above.

THE WARRANTOR SHALL NOT BE LIABLE FOR INCIDENTAL OR CONSEQUENTIAL DAMAGES RESULTING FROM THE USE OF THIS PRODUCT, OR ARISING OUT OF ANY BREACH OF THIS WARRANTY. ALL EXPRESS AND IMPLIED WARRANTIES, INCLUDING THE WARRANTIES OF MERCHANTABILITY AND FITNESS FOR A PARTICULAR PURPOSE, ARE LIMITED TO THE APPLICABLE WARRANTY PERIOD SET FORTH ABOVE.

Some states do not allow the exclusion or limitation of incidental or consequential damages, or limitations on how long an implied warranty lasts, so the above exclusions or limitations may not apply to you.

This warranty gives you specific legal rights and you may also have other rights which vary from state to state. If a problem with this product develops during or after the warranty period, you may contact your dealer or Servicenter. If the problem is not handled to your satisfaction, then write to the Customer Satisfaction Center at the company address indicated in the Servicenter Directory.



For Product Information, Operating Assistance, Literature Request, Dealer Locations, and all Customer Service inquiries please contact:

**1-800-211-PANA(7262)**, Monday-Friday 9am-9pm,  
Saturday-Sunday 9am-7pm, EST.

Web Site: <http://www.Panasonic.com>  
You can purchase parts, accessories  
or locate your nearest servicer by  
visiting our Web Site.

### Accessory Purchases:

**1-800-332-5368 (Customer Orders Only)**

**Panasonic Services Company 20421 84th Avenue South, Kent, WA 98032**

**(6 am to 5 pm Monday - Friday; 6 am to 10:30 am Saturday; PST)**

**(Visa, MasterCard, Discover Card, American Express, Check)**

### Factory Servicenters Locations

#### CALIFORNIA

6550 Katella Avenue  
Cypress, CA 90630

800 Dubuque Avenue  
S. San Francisco  
CA 94080

20201 Sherman Way  
Suite 102  
Canoga Park, CA 91306

3878 Ruffin Road  
Suite A  
San Diego, CA 92123

#### COLORADO

1640 South Abilene Street  
Suite D  
Aurora, CO 80012

#### FLORIDA

3700 North 29th Avenue  
Suite 102  
Hollywood, FL 33020

#### GEORGIA

8655 Roswell Road  
Suite 100  
Atlanta, GA 30350

#### ILLINOIS

9060 Golf Road  
Niles, IL 60714

1703 North Randall Road  
Elgin, IL 60123  
(Pick-up/Drop-off only)

#### MARYLAND

62 Mountain Road  
Glen Burnie, MD 21061

#### MASSACHUSETTS

60 Glacier Drive  
Suite G  
Westwood, MA 02090

#### MICHIGAN

37048 Van Dyke Avenue  
Sterling Heights, MI 48312

#### MINNESOTA

7850-12th Avenue South  
Airport Business Center  
Bloomington, MN 55425

#### OHIO

2236 Waycross Road  
Civic Center Plaza  
Forest Park, OH 45240

#### PENNSYLVANIA

2221 Cabot Blvd. West  
Suite B  
Langhorne, PA 19047

Chartiers Valley  
Shopping Center  
1025 Washington Pike  
Bridgeville, PA 15017

#### TENNESSEE

3800 Ezell Road  
Suite 806  
Nashville, TN 37211

#### TEXAS

7482 Harwin Drive  
Houston, TX 77036

13615 Welch Road  
Suite 101  
Farmers Branch  
TX 75244

#### WASHINGTON

20425-84th Avenue South  
Kent, WA 98032

#### HAWAII

99-859 Iwaiwa Street  
Aiea, Hawaii 96701  
Phone (808) 488-1996  
Fax (808) 486-4369

### Service in Puerto Rico

**Matsushita Electric of Puerto Rico, Inc. Panasonic Sales Company/Factory Servicenter:**  
**Ave. 65 de Infantería, Km. 9.5, San Gabriel Industrial Park, Carolina, Puerto Rico 00985**  
**Phone (787) 750-4300 Fax (787) 768-2910**

## For product service

- Panasonic Servicenters are listed in the servicenter directory.
- Call 1-800-211-PANA(7262).

## When you ship the product

- Carefully pack your unit, preferably in the original carton.
- Attach a letter, detailing the symptom, to the outside of the carton.

Symptom \_\_\_\_\_

---

- Send the unit to an authorized servicenter, prepaid and adequately insured.
- Do not send your unit to the Panasonic Consumer Electronics Company listed below or to executive or regional sales offices. These locations do not repair consumer products.

## For your future reference

Serial No. \_\_\_\_\_

Date of purchase \_\_\_\_\_

(found on the bottom of the unit)

Name and address of dealer \_\_\_\_\_

**Panasonic Consumer Electronics Company,**  
**Division of Matsushita Electric Corporation of America**  
One Panasonic Way, Secaucus, New Jersey 07094

**Panasonic Sales Company,**  
**Division of Matsushita Electric of Puerto Rico, Inc.**  
Ave. 65 de Infantería, Km. 9.5, San Gabriel Industrial Park  
Carolina, Puerto Rico 00985

Printed in the United Kingdom

**PQQX10442WA** S0993T4119

## Free Manuals Download Website

<http://myh66.com>

<http://usermanuals.us>

<http://www.somanuals.com>

<http://www.4manuals.cc>

<http://www.manual-lib.com>

<http://www.404manual.com>

<http://www.luxmanual.com>

<http://aubethermostatmanual.com>

Golf course search by state

<http://golfingnear.com>

Email search by domain

<http://emailbydomain.com>

Auto manuals search

<http://auto.somanuals.com>

TV manuals search

<http://tv.somanuals.com>