

Panasonic

AUTOMATIC TELEPHONE
ANSWERING SYSTEM

EASA-PHONE®

Model No. **KX-T5200**

Operating Instructions

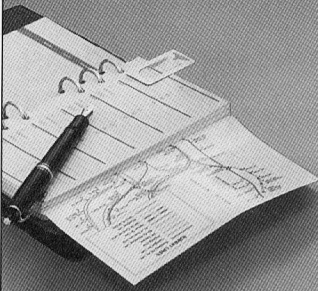

Please read before use.

AUTO-LOGIC™

Please read **IMPORTANT SAFETY INSTRUCTIONS** on pages 47 and 48 before use. Read and understand all instructions.

Introduction (Features)

Thank you for purchasing the Panasonic KX-T5200.

The KX-T5200 is an automatic telephone answering system with dual micro cassette tapes. You can use the following convenient features.

- **New message playback** (p. 23)
Listening to only the messages you have not played back before
- **Voice prompts** (p. 13, 16, 32)
For time, voice remote menu, number of messages, pre-recorded greeting message, and time/day stamp on each message
- **Pre-recorded greeting message** (p. 16)
- **Tone remote operation** (p. 30-42)
Listening to all messages or new messages from a remote location with touch tone phone

Accessories (For accessory order, call toll free 1-800-332-5368.)

AC Adaptor (KX-A11)
(p. 9)

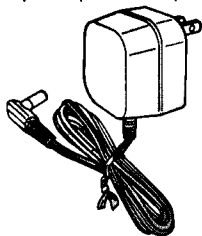

one

Telephone Line Cord
(p. 9)

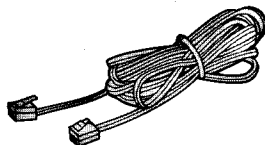

one

Micro Cassette Tapes (p. 8, 46)
Greeting Message Tape (MC-10)

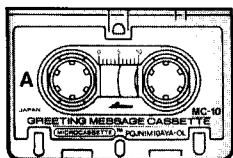

one

Incoming Message Tape (MC-30)

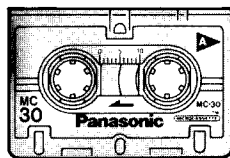

one

Contents

Location of controls	5
Display	7
Setting up the unit	8
Inserting the cassette tapes	8
Connection	9
Setting selectors	10
Time and day adjustment	12
Recording a personal greeting message	14
Pre-recorded greeting messages	16
Checking the greeting message	17
Setting the CPC (Calling Party Control) function	18
Setting the greeting monitor function	19
Automatic answering operation	20
Setting the unit to answer the call	21
Selecting the greeting message	21
Listening to the recorded messages	22
Listening to new messages only	23
Listening to all the recorded messages	23
Saving some old messages	25
Resetting the incoming message tape	26
Erasing the recorded messages	26

Recording your own message	27
Recording a telephone conversation	28
Monitoring incoming calls	29
Remote operation from a touch tone phone	30
Setting the remote code number	30
Going into voice menu	31
List of the voice menu	32
Direct remote operation (Basic)	34
Direct remote operation (Advanced)	36
Troubleshooting guide	43
Maintenance	45
Important safety instructions	47
FCC and other information	49

Location of controls

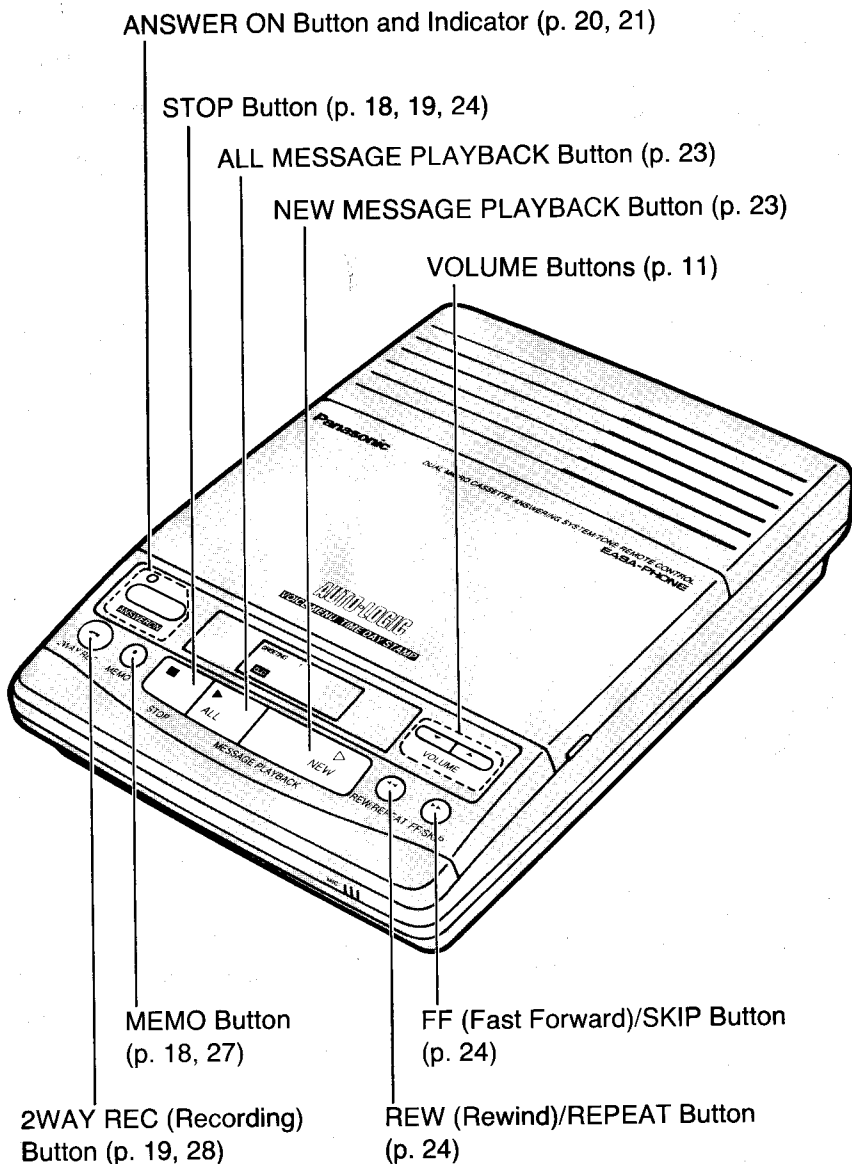

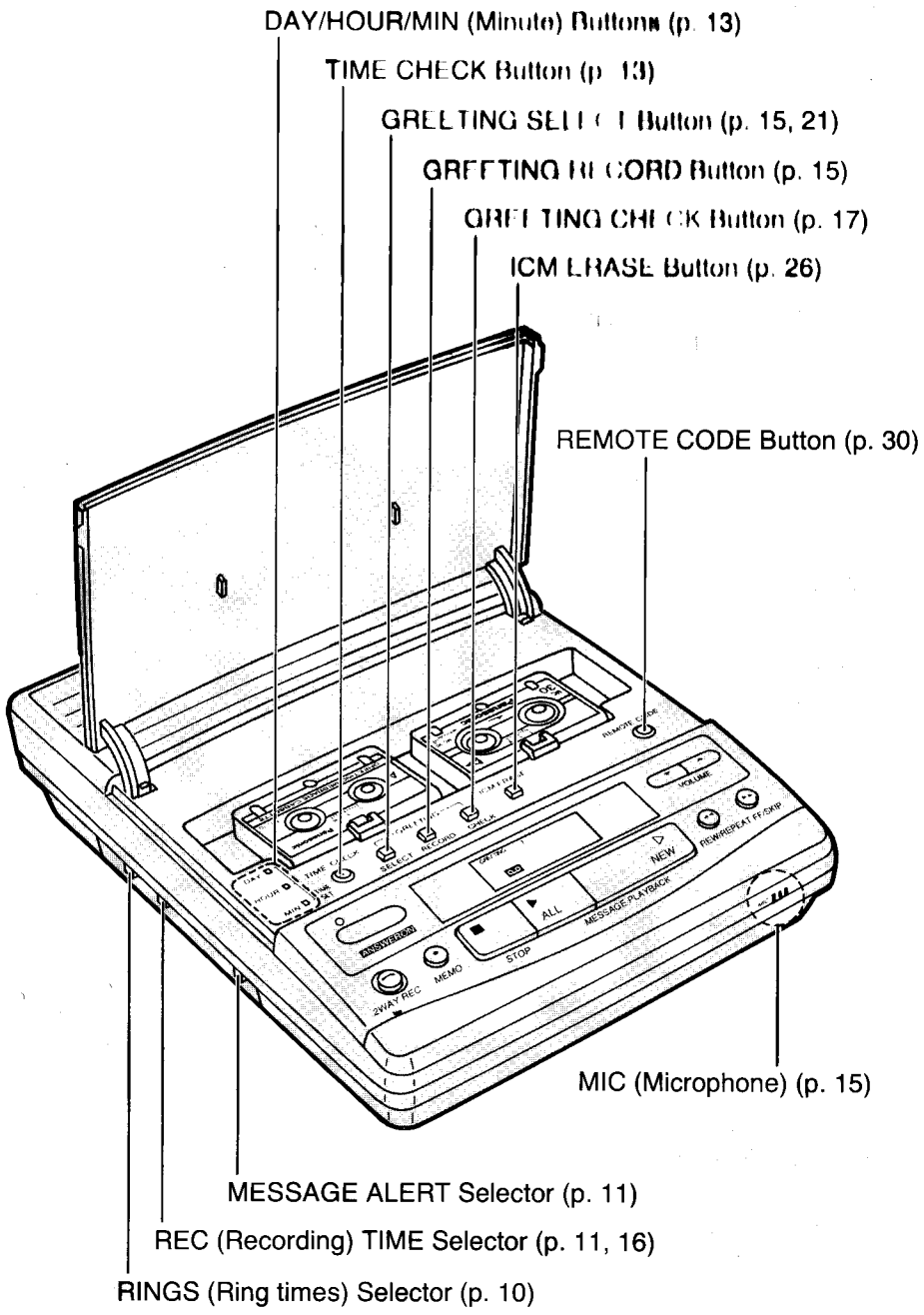

Display

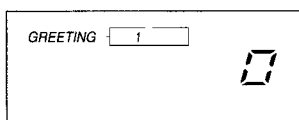

First greeting message is selected. (pages 15 and 21)
No messages have been recorded.

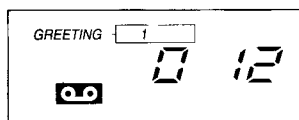

The first greeting is being recorded. The call counter counts the recording duration. (page 15)

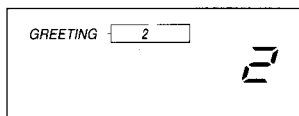

Second greeting message is selected. (pages 15 and 21)
2 messages have been recorded.

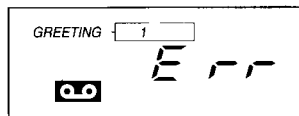

When recording the first greeting message, it results in failure.

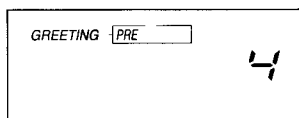

Pre-recorded greeting message is selected. (pages 16 and 21)
4 messages have been recorded.

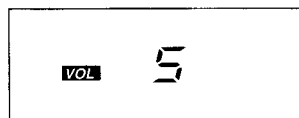

You are adjusting the volume. The number shows the current volume level. (page 11)

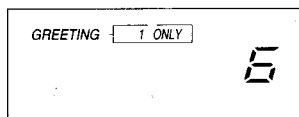

First greeting message is selected and the REC TIME selector is in the GREETING ONLY position. (page 11)

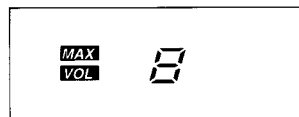

When the volume level is set to maximum (8).

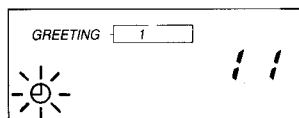

The clock in the unit is not adjusted. Program it before use. (page 12)

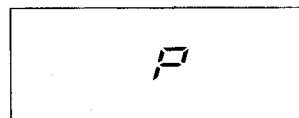

The unit is in the programming mode. (pages 18 and 19)

Setting up the unit

Inserting the cassette tapes

Remove the stopper of the micro cassette tapes.

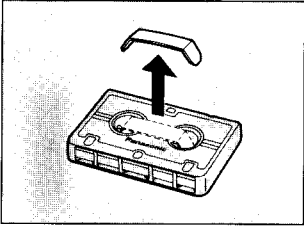

Open the cassette panel.

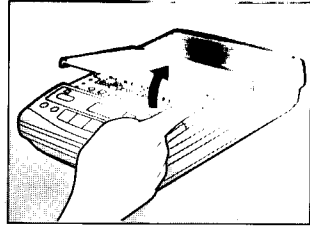

Insert micro cassette tapes with the full reel of each tape to the left.

Greeting Message Tape
(MC-10)

Incoming Message Tape
(MC-30)

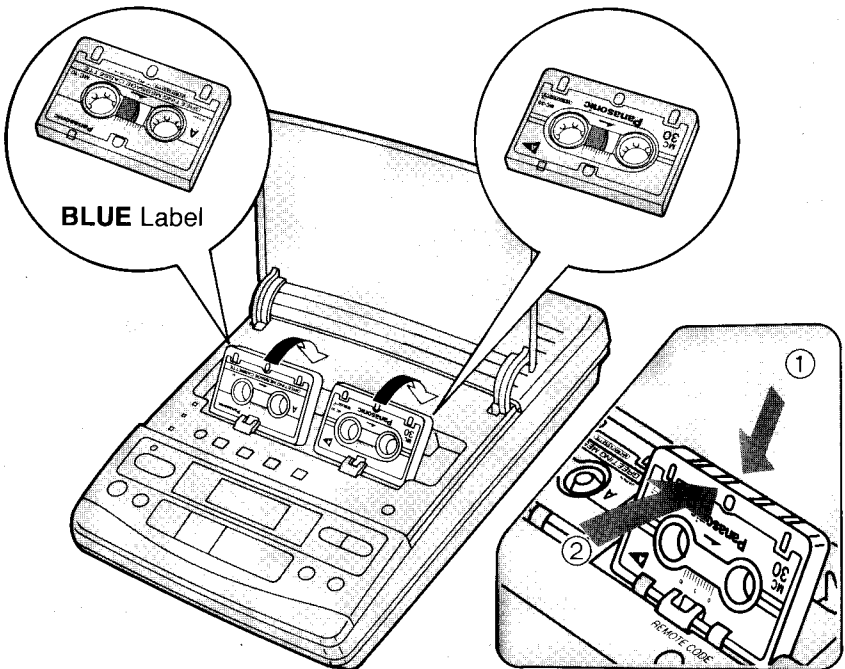

Connection

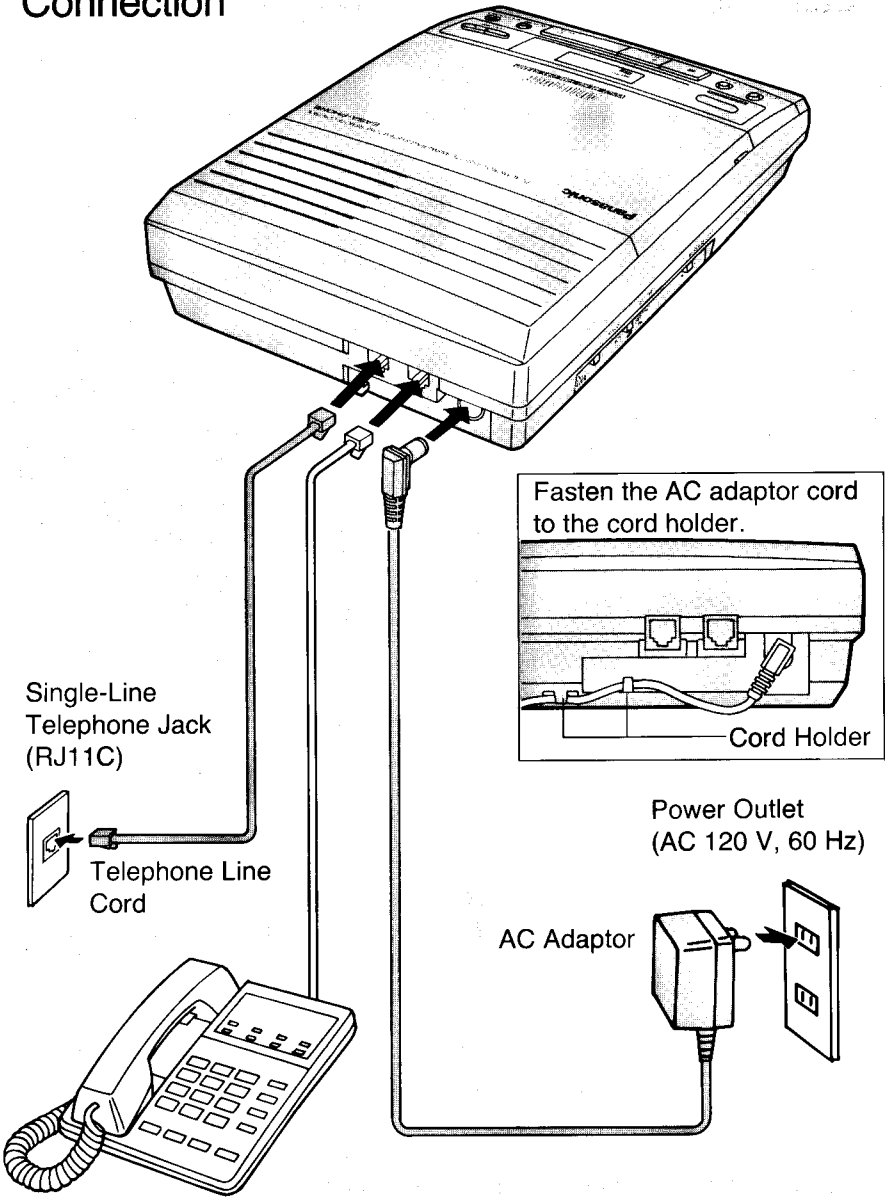

Notes:

- USE ONLY Panasonic AC ADAPTOR KX-A11.
- AC adaptor must remain connected at all times.

Setting selectors

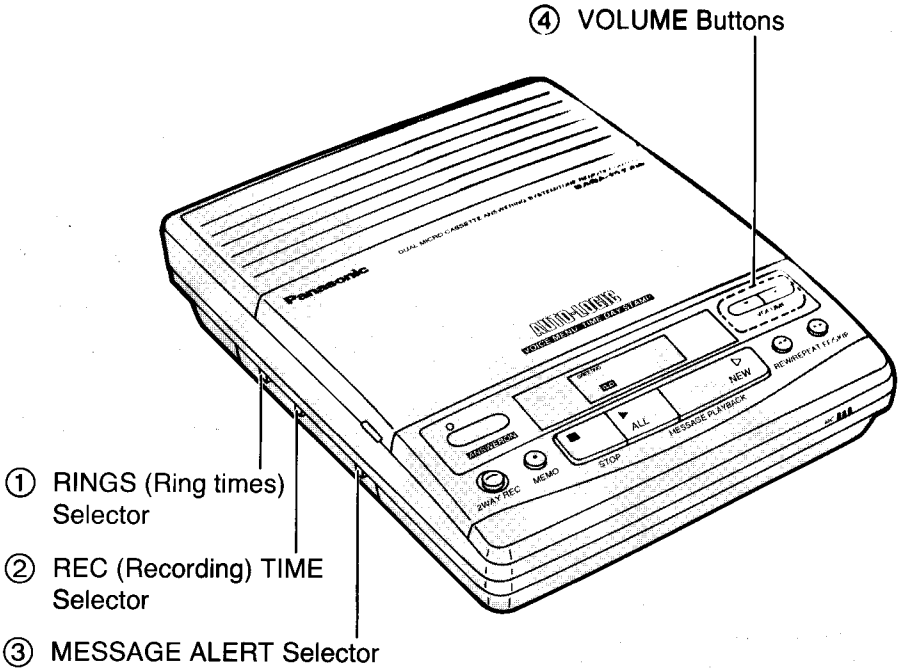

① RINGS (Ring times) Selector

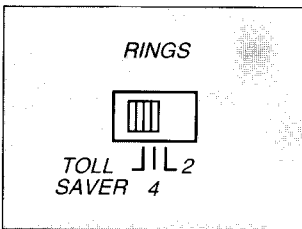

Used to select the number of rings before the unit answers.

2: The unit answers a call on the second ring.

4: The unit answers a call on the fourth ring.

TOLL SAVER: See below.

Toll saver

When you call the unit from a touch tone telephone, the number of rings before the unit answers informs you if there are any new messages.

—If the unit answers on the 2nd ring: There is at least one new message.

—If the unit answers on the 4th ring: There are no new messages.

Hang up immediately when you hear the 3rd ring. Because the 3rd ring indicates there are no new messages. This saves you the toll charge for the call.

② REC (Recording) TIME Selector

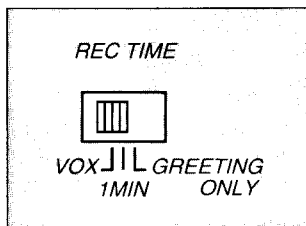

Used to select the caller's recording time.

VOX: Unlimited.

1 MIN: Limited to 1 minute.

GREETING ONLY:

When a call comes in, the unit answers the call, plays the greeting message, then hangs up. The unit will not record any caller's message.

③ MESSAGE ALERT Selector

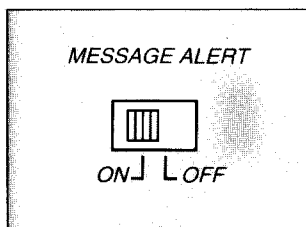

When you come home, you can be informed that new messages have been recorded by the presence of an audible beep.

ON: When new messages have been recorded, a short beep sounds every 10 seconds. The beeping stops after the messages have been played back.

OFF: No beep sounds.

④ Volume Buttons

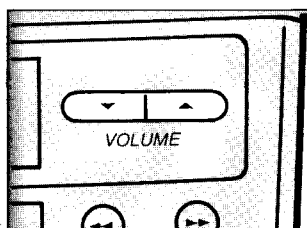

Used to select the speaker volume level. There are 8 levels, 0 (minimum) through 8 (maximum).

To increase the volume, press ▲.

To decrease the volume, press ▼.

—The display shows the selected volume level for 3 seconds.

Time and day adjustment

TIME CHECK Button

DAY Button

HOUR Button

MIN Button

To increase the volume, press ▲.
To decrease the volume, press ▼.

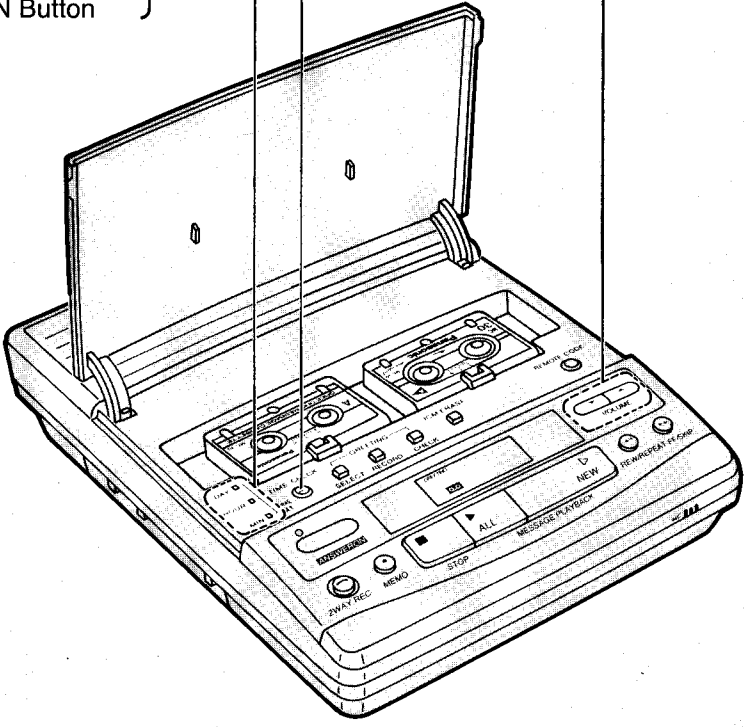

Notes:

- During a power failure, the programmed time and day retention time is approximately 3 hours.
- If “⌚” flashes, it means that the programmed time and day have been cleared. In this case, adjust the time and day again.

1

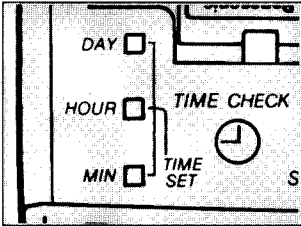

Press the DAY button repeatedly to adjust the day.

—The unit announces the day.

2

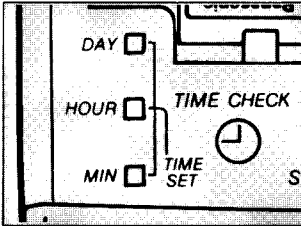

Press the HOUR button repeatedly to adjust the hour.

—The unit announces the hour.

3

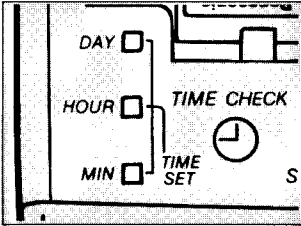

Press the MIN button repeatedly to adjust the minute.

—The unit announces the minute.
—The clock starts working.

Voice Time and Day Stamp

You can know when the caller's messages were recorded by the recorded synthesized voice telling the time and day after each message.

To check the time and day

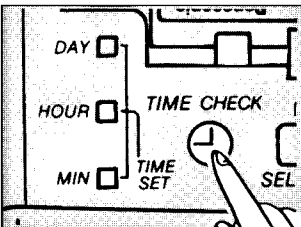

Press the TIME CHECK button.

—The unit announces the programmed time and day.

Recording a personal greeting message

You can record two greeting messages.

First greeting: Its recording time is limited to 30 seconds. So you may leave a short message to your callers.

Second greeting: This is an extended greeting message and its recording time is up to the tape end. So you can leave any kind of messages you like, for example, an advertisement for your company.

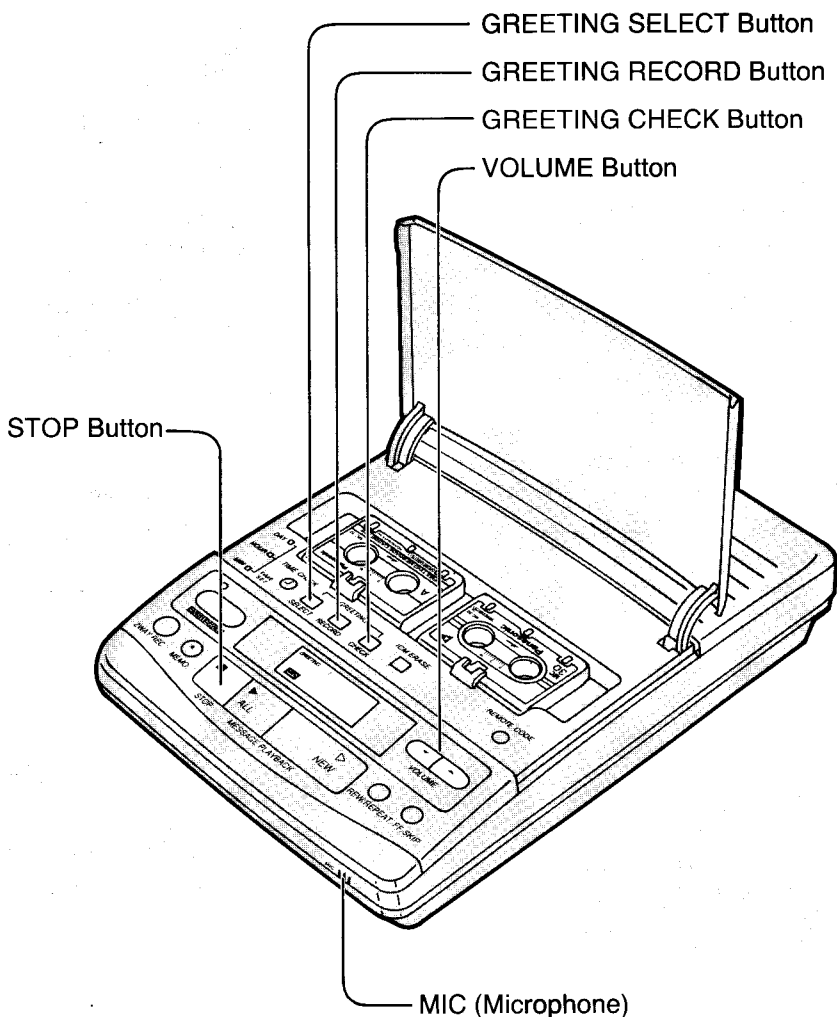

Do not pause for over 5 seconds while recording. If 6 beeps sound while recording and "Record greeting again." is announced, start again from step 2 after resetting the greeting message tape.

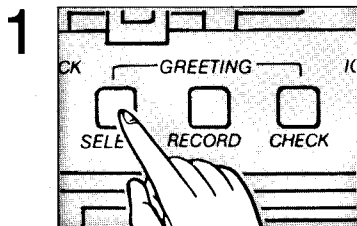

Press the GREETING SELECT button to select greeting 1 or 2.

First greeting is selected.

Display: GREETING—

Second greeting is selected.

Display: GREETING—

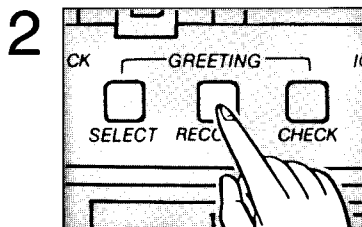

Press the GREETING RECORD button, then release it.

—"Record greeting after the beep." is announced, followed by a long beep.

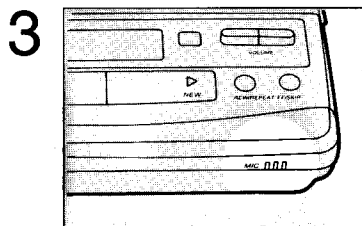

Immediately after the long beep, speak clearly and loudly, 20 cm (8") away from the MIC (microphone).

—The display shows the elapsed recording time and "00" flashes.

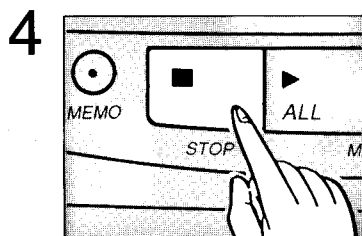

When you finish recording, press the STOP button.

Pre-recorded greeting messages

The unit has two pre-recorded greeting messages.

To select the pre-recorded greeting message

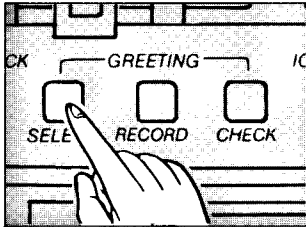

Press the GREETING SELECT button to select the pre-recorded message.

—Display shows:

GREETING— PRE

—The pre-recorded greeting message is played back automatically.

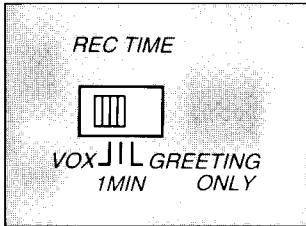

When the REC TIME selector is in the VOX or 1 MIN position:

"Hello, we are not available now. Please leave your name and phone number after the beep. We will return your call."

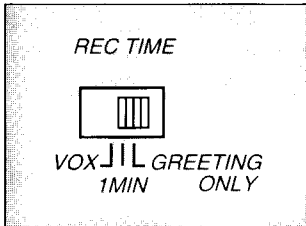

When the REC TIME selector in the GREETING ONLY position:

"Hello, we are not available now. Please call again. Thank you for your call."

Checking the greeting message

You can play back and check your recorded greeting message.

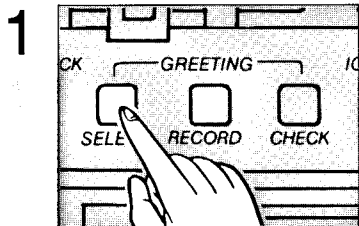

Press the GREETING SELECT button to select the greeting message you want to check.

—The selected greeting message is marked on the call counter.

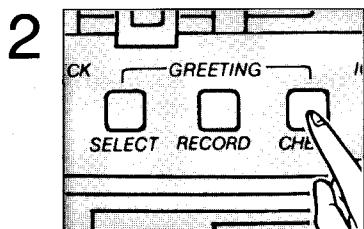

Press the GREETING CHECK button to play back the greeting message.

—Adjust the speaker volume using the VOLUME buttons.

Samples of greeting messages

When the REC TIME selector is in the VOX (unlimited) position:

“Hello, this is (your name and/or number). Sorry, I cannot take your call. Please leave your message after a long beep. Thank you.”

When the REC TIME selector is in the 1 MIN position:

“Hello, this is (your name and/or number). Sorry, I cannot take your call. Please leave your message after a long beep. Your recording time is up to 1 minute. Thank you.”

When the REC TIME selector is in the GREETING ONLY position:

“Hello, this is (your name and/or number). Sorry, I cannot take your call. If you call back tomorrow, I’ll be happy to talk to you. Thank you.”

Setting the CPC (Calling Party Control) function

With this function, the unit senses the hung-up click and stops recording, thereby maximizing the time available on your cassette tape.

The CPC function of this unit is preset to "A" position.
If you have call waiting service, set to "b" position.
Otherwise, leave in "A" position.

1

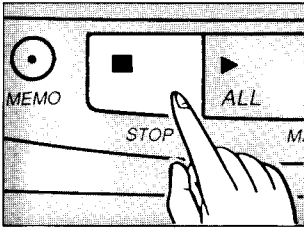

Press the STOP button until the display shows "P".

2

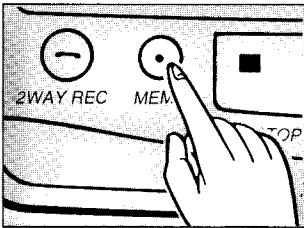

Within 7 seconds after pressing the STOP button, press the MEMO button to set "A" or "b".

—The display shows the current setting.

A or b

—Each time you press the MEMO button, "A" or "b" will change alternately.

—Wait for 7 seconds after setting. Then the setting indicated on the display is stored.

—To check the CPC function, repeat from step 1 to 2.

Setting the greeting monitor function

You can choose if you hear the greeting message or not while monitoring calls.

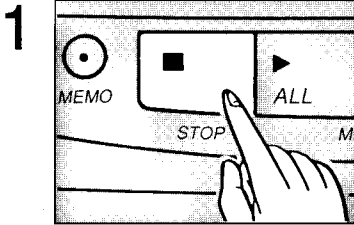

Press the STOP button until the display shows "P".

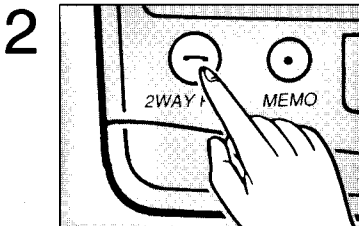

If you want to hear the greeting message:

Press the 2WAY REC button until "1 (ON)" is displayed.

If you do not want to hear the greeting message:

Press the 2WAY REC button until "0 (OFF)" is displayed.

- Each time you press the 2WAY REC button, "1 (ON)" or "0 (OFF)" will change alternately.
- Wait for 7 seconds after setting. Then the setting indicated on the display is stored.
- To check the current setting, repeat from step 1 to 2.

Automatic answering operation

When a call is received, the unit plays back your greeting message, and records the caller's message. After the call is completed, it will be ready for the next call automatically.

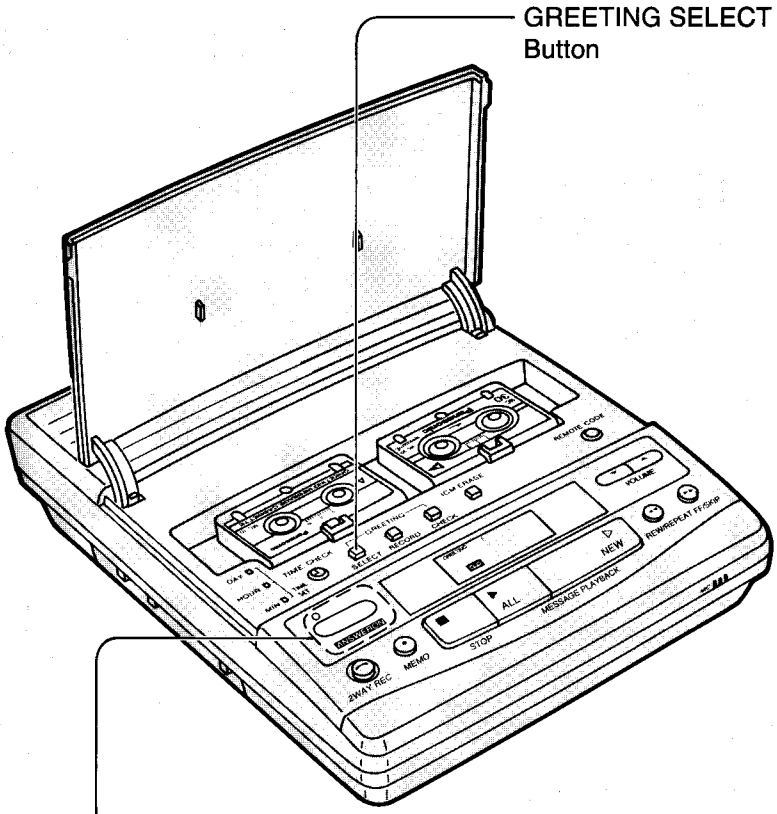

ANSWER ON Button and Indicator

The answering system works when the **ANSWER ON** indicator light is on.



Setting the unit to answer the call

Set the unit as follows to answer a call and record messages.

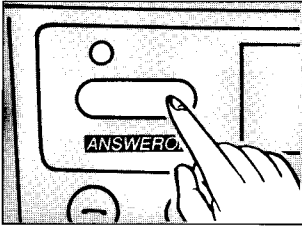

Press the ANSWER ON button to turn on the answering system.

- “Answer set” is announced.
- The ANSWER ON indicator light is on and the unit is now ready to answer the call.

To turn off the unit

If you do not want the unit to answer the call, press the ANSWER ON button, and confirm the ANSWER ON indicator light goes out.

When you turn off the unit, the unit answers call after 15 rings and record the incoming call. (Remote turn on feature)

Selecting the greeting message

Which greeting message is played back to the caller depends upon the selection of 1, 2 or PRE (Pre-recorded greeting message).

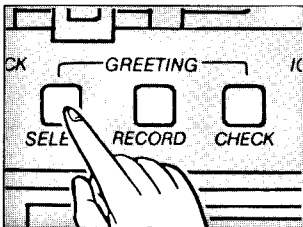

Press the GREETING SELECT button.

- The selected greeting message is marked on the display.

First greeting is selected.

Display: GREETING—

Second greeting is selected.

Display: GREETING—

Pre-recorded greeting is selected.

Display: GREETING—

Listening to the recorded messages

- When new incoming messages have been recorded;
 - the NEW MESSAGE indicator flashes.
 - the call counter shows the number of recorded messages up to 30.
 - a short beep sounds every 10 seconds if the MESSAGE ALERT selector is set to the ON position.

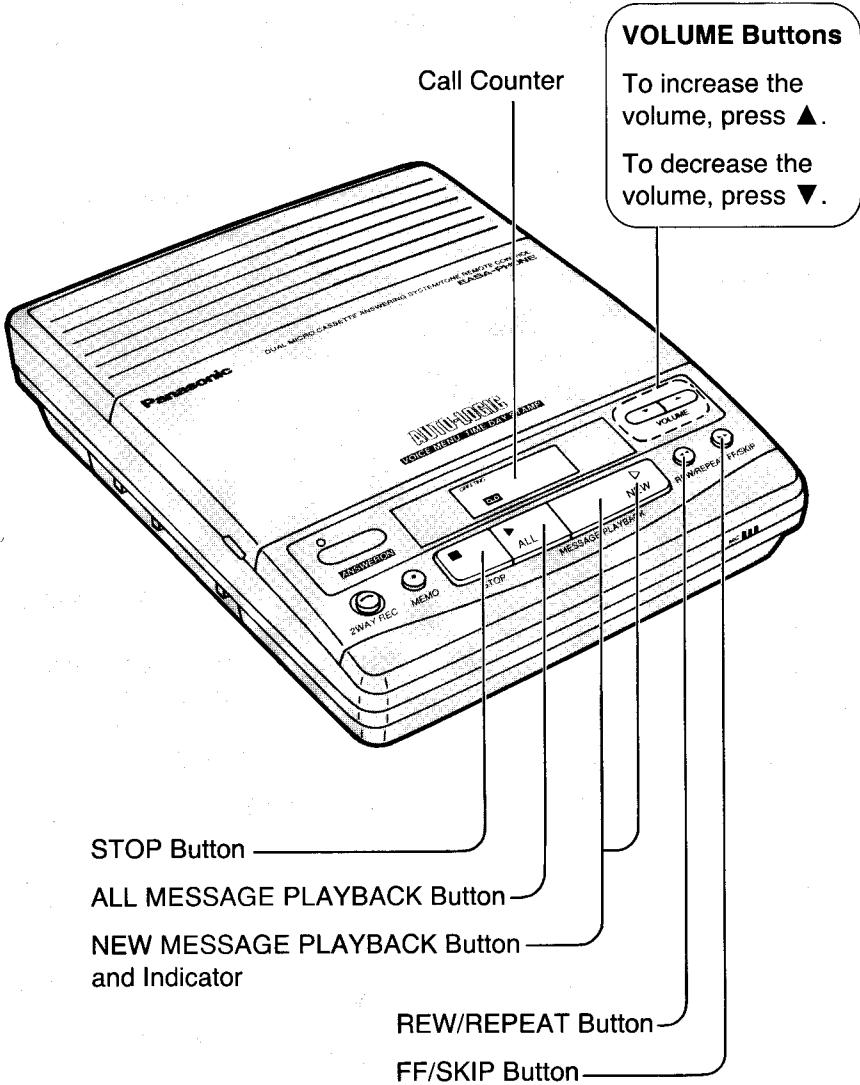

Listening to new messages only

Only new messages are played back. Messages once reviewed will not be played back.

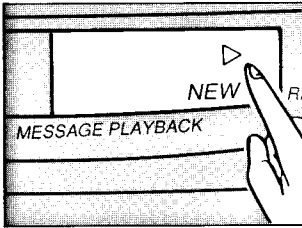

Press the **NEW MESSAGE PLAYBACK** button.

- The unit plays back new messages.
- The call counter shows the message number being played back.

Listening to all the recorded messages

All the recorded messages—including those previously reviewed or saved—will be played back from the beginning of the tape.

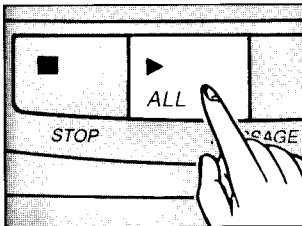

Press the **ALL MESSAGE PLAYBACK** button.

- The unit plays back all the recorded messages.
- The call counter shows the message number being played back.

AUTO-LOGIC™

By pressing a **MESSAGE PLAYBACK** button, the unit automatically;

- rewinds the tape and plays back the messages
- beeps once after each message with announcement of time and day
- stops the tape and announces “End of final message” after the last message has been played
- prepares to record new messages after the old messages

The following functions are available during message playback.

To repeat the message during playback

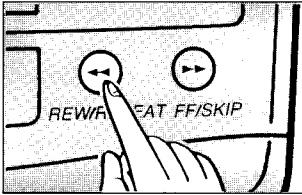

Press the REW/REPEAT button.

- The unit rewinds the tape to the beginning of the message and starts playback again.

Note:

- If you press the REW/REPEAT button within 5 seconds of playing back the message, the unit will play back messages from the one before.

To skip the message during playback

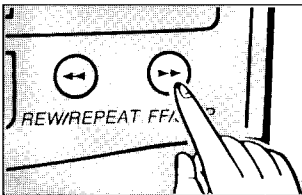

Press the FF/SKIP button.

- The unit forwards the tape to the beginning of the next message and starts playback again.

To stop the operation

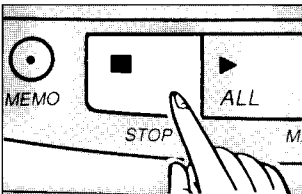

Press the STOP button to stop playing back, or other operation.

In case your unit is not in playback operation.

When you press the REW/REPEAT button, the unit rewinds the tape to the beginning automatically.

When you press the FF/SKIP button, the unit forwards the tape to the end of the last message automatically.

Saving some old messages

If you do not want to clear away some old messages previously recorded, you can save them.

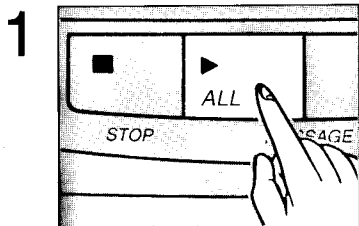

Press the **ALL MESSAGE PLAYBACK** button to play back the messages.

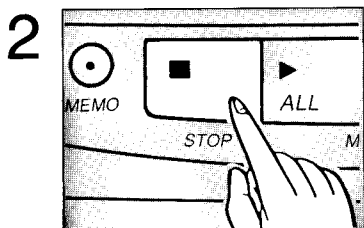

Press the **STOP** button at the end of the message you want to save.

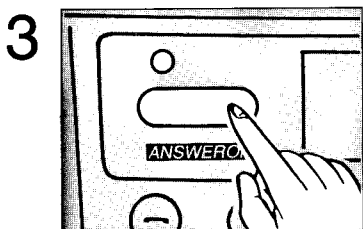

Press the **ANSWER ON** button to turn on the answering system.

- The **ANSWER ON** indicator light is on.
- The new messages will be recorded after the message(s) you have saved.
- The call counter shows the total number of messages on the tape.

Resetting the incoming message tape

To record new messages from the beginning of the incoming message tape, rewind the incoming message tape.

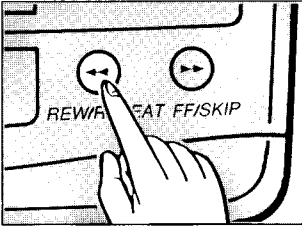

Press the REW/REPEAT button after playback.

- The new messages will be recorded from the beginning of the tape.
- The call counter shows "0".

Erasing the recorded messages

After playback, you can erase the messages on the tape.

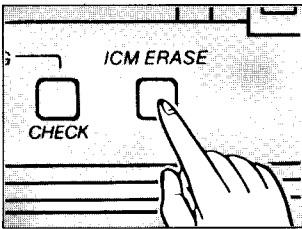

Press the ICM ERASE button.

- The unit erases the messages while the tape being rewind.
- The call counter shows "0".
- To stop erasing, press the STOP button.

Recording your own message

You may record a personal message on the ICM tape. It can be heard by anyone playing back messages remotely or manually.

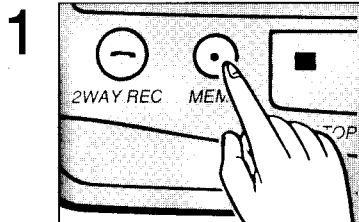

Press the MEMO button.

- A beep sounds.
- The number on the call counter increases by one.

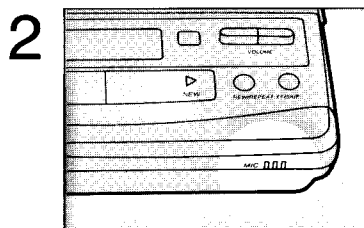

Immediately after the beep, speak clearly and loudly, 20 cm (8") away from the microphone.

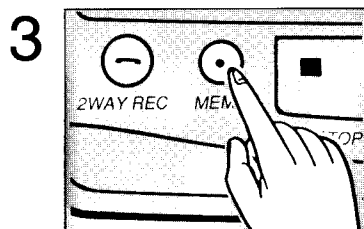

To stop recording, press the MEMO button.

Recording a telephone conversation

While speaking with someone on the telephone, you can record your conversation.

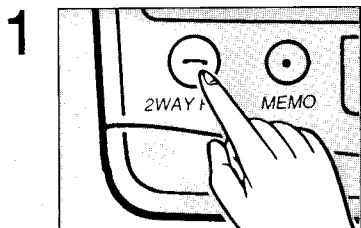

During your conversation, press the 2WAY REC button.

- A beep sounds.
- The number on the call counter increases by one.



Continue your conversation.

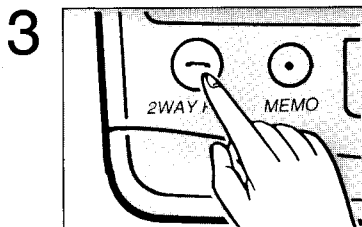

To stop recording, press the 2WAY REC button.

Note:

- Many states have imposed regulations on the manner in which 2-way telephone conversations may be recorded, so you should inform the other party that the conversation is being recorded. Consult your local telephone company for further information.

Monitoring incoming calls ---

While an incoming call is being recorded, you can monitor the caller's voice through the speaker and answer it if you want.

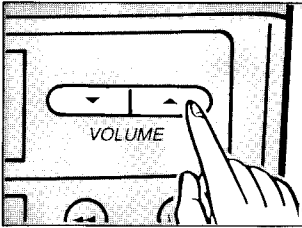

Adjust the volume using the VOLUME button.

Helpful hints:

- To answer the call while monitoring, lift up the telephone handset connected with the same line and talk. The unit stops recording.
- You can also answer the call while the unit is playing the greeting message in the same way.
If the unit does not stop playing the greeting, press the hookswitch on the telephone for about one second, and release it.
- You can choose if you hear the greeting message or not while monitoring calls. (See page 19.)

Remote operation from a touch tone phone

You can operate your answering system remotely with a touch tone telephone while you are away from home.

The synthesized voice gives directions on how to operate your unit.

—To operate the unit directly, skipping the order of the voice menu, see pages 34 through 38.

—For Toll Saver feature, see page 10.

Setting the remote code number

The remote code number prevents unauthorized persons from accessing your unit and listening to your messages. You can choose any 2-digit number (00 to 99) for your remote code number.

1

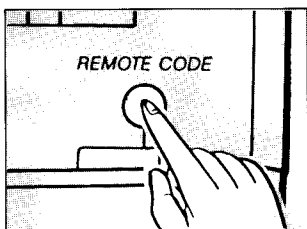

Press the REMOTE CODE button.

—The display shows the current remote code number.

2

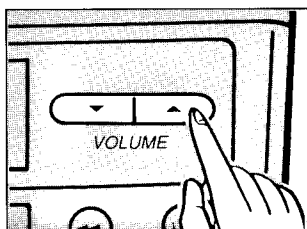

Within 7 seconds after pressing the REMOTE CODE button, press the VOLUME buttons (▲ or ▼) repeatedly to select the number.

—Wait for 7 seconds after selecting the number.
The number on the display is then stored.

To check the remote code

Press the REMOTE CODE button.

The display shows the programmed remote code number for 7 seconds.

Going into voice menu

1

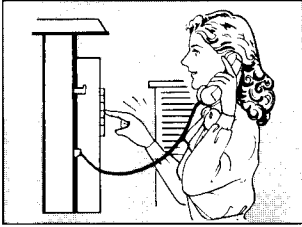

Call your unit from a touch tone telephone.

2

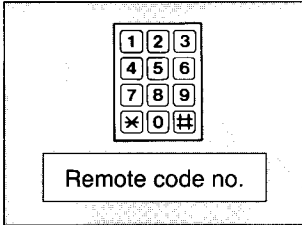

Press your remote code number during greeting message playback.

—The unit tells you the number of recorded messages.

3

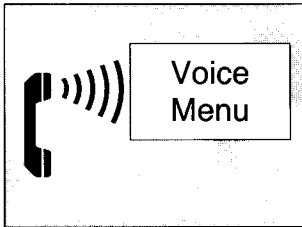

After 3 seconds, the unit starts the voice menu function.

—“Press 1 to play back all messages, press 2 for other functions.” is announced.

4

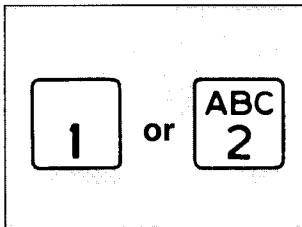

Press “1” to use the announced feature or press “2” to proceed to other functions.

List of the voice menu

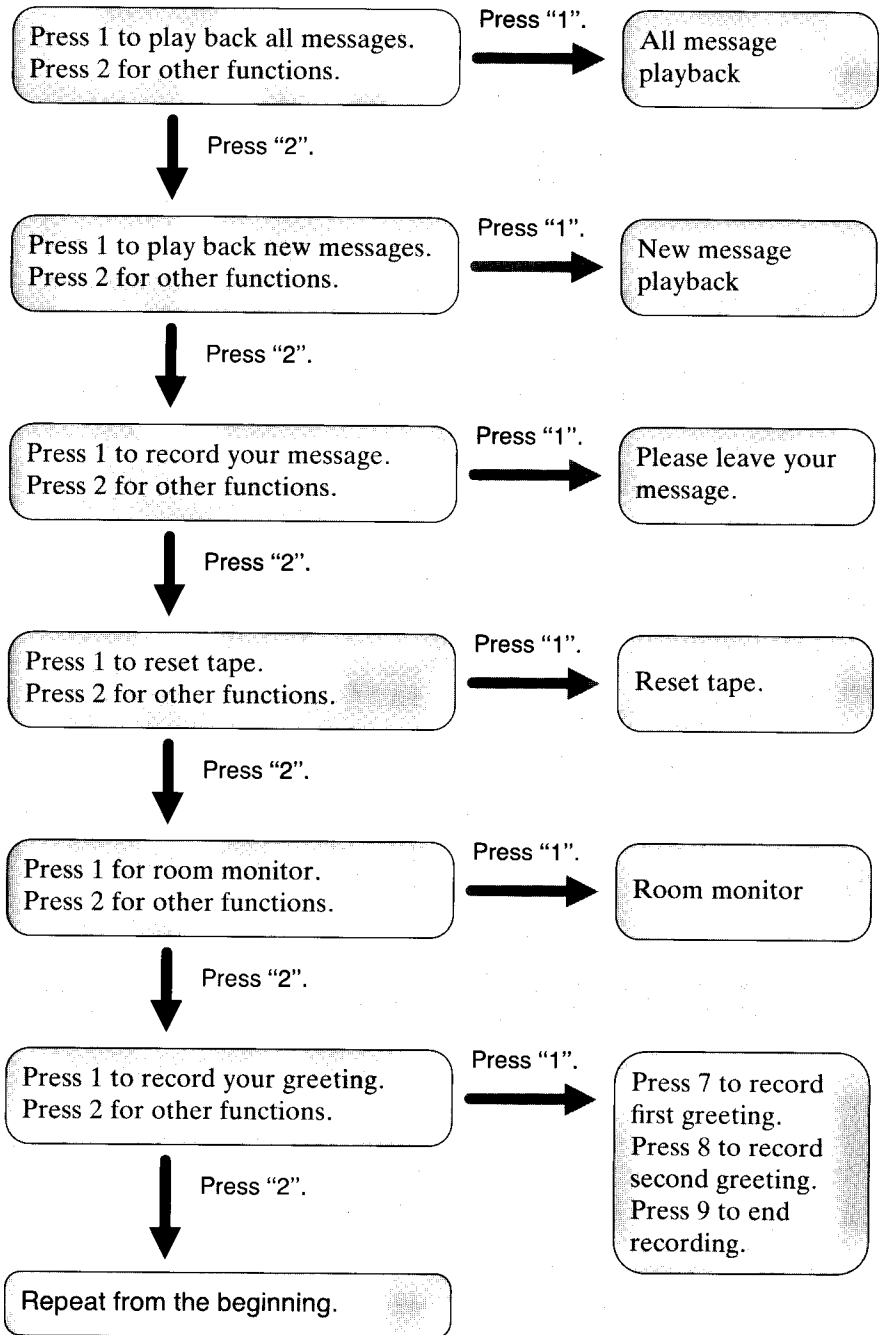



All messages playback

The unit plays back all the recorded messages. At the end of the last message, "End of final message" is heard.

If you want to continue the voice menu operation, wait for 5 seconds, the unit will restart voice menu from the beginning.

If you hear "End of tape" after retrieving your messages, the tape is full. You must reset the tape.



New message(s) playback

The unit plays back only messages that were recorded since the last time you retrieved.



Leaving your message

You can leave a memo message.

1. Speak after announcement "Please leave your message."
2. When you finish recording, hang up.



Reset tape

You can reset the tape to record the new messages from the beginning of the tape.



Room monitor

You can monitor the sound in the room where the unit is installed for about 30 seconds.



Recording a greeting message

You can re-record your greeting message.

1. Press "7" or "8".
You hear announcement "Recording first (second) greeting", followed by a long beep.
2. Speak after the long beep.
3. When you finish recording, press "9".

—Do not pause for over 5 seconds while recording.

If you hear "Record greeting again.", repeat from step 1.

Direct remote operation (Basic)

You can also retrieve your messages and control the unit directly in lieu of using the voice menu.

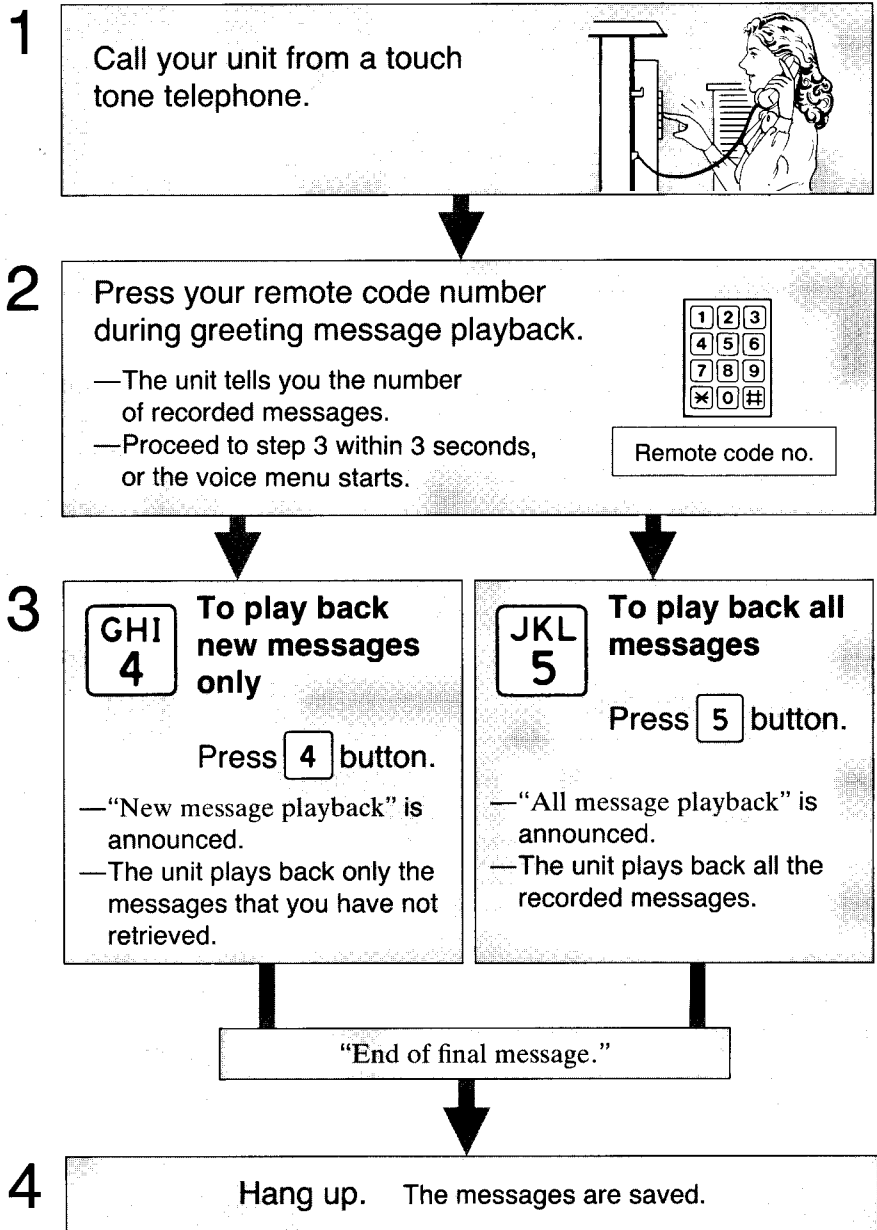

During playback

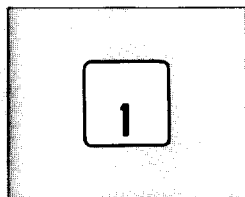

Repeating a message

Press **1** button.

- “Repeat” is heard. The unit resumes playback at the beginning of the message.
- If you press “1” within 5 seconds of playing back the message, the unit will play back message from the one before.

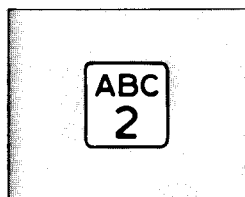

Skipping a message

Press **2** button.

- “Skip” is heard. The unit starts to play back the next message.

To reset the tape after playback

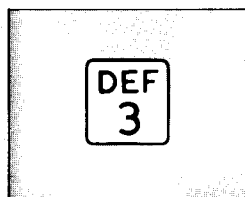

Press **3** button within 5 seconds.

- “Reset tape” is heard.
- When you played back all messages, the unit rewinds the tape to the beginning and “The tape is reset.” is heard.
- When you played back only new messages, the unit rewinds the tape to the beginning of new messages and a beep sounds.

If you want to rewind the tape to the beginning after played back only new messages:

Press **3** button again after hearing a beep.

- The unit rewinds the tape to the beginning.

If you want to cancel the resetting of the tape:

Press **2** button.

Direct remote operation (Advanced)

1

Call your unit from a touch tone telephone.

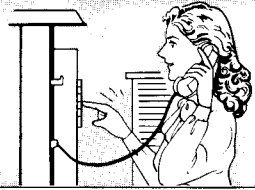

2

Press your remote code number during greeting message playback.

- The unit tells you the number of recorded messages.
- Proceed to step 3 within 3 seconds, or the voice menu starts.



Remote code no.

3

To re-record the greeting message

- ① Press **7** button to re-record first greeting message.
Press **8** button to re-record second greeting message.

—The unit rewinds the tape, then “Record greeting after the beep.” is announced, followed by a long beep.

- ② Speak immediately after a long beep.

—Do not pause for over 5 seconds. If “Record greeting again.” is heard, start again from step ① within 10 seconds.

- ③ To stop recording, press **9** button.

—The newly recorded greeting message will be played back.
—When you want to re-record, start again from step ①.

4

Hang up to end the remote operation.

To skip the greeting message (For outside caller)

Press ***** button during greeting message playback.

—Callers can record their messages without listening to your greeting message.

To change the greeting message to first

Press ***** **1** button.

To change the greeting message to second

Press ***** **2** button.

To change the greeting message to pre-recorded

Press ***** **3** button.

—The selected greeting message is played back.

To monitor the room sound

Press **6** button.

—“Room monitor” is announced.

—You can monitor the sound in the room where the unit is installed for 30 seconds.

—A beep sounds when 30 seconds are up.

If you want to monitor again after the time-out has come;

Press **6** button again within 3 seconds of hearing the beep.

To turn off the answering system

1. Call your unit from a touch tone telephone.
2. Press your remote code number during greeting message playback.
The unit announces the number of recorded messages.
3. Press **0** button.
“Answer off. Thank you for your call.” is announced.
Then hang up.

To turn on the answering system

You can easily turn on the answering system from another location even when you forgot to turn it on.

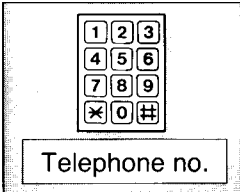
1.  Call your unit.

2.  Wait for 15 rings.

—The unit will answer, and the greeting message is heard.
Then, hang up.

OPERATION FROM TONE PHONE

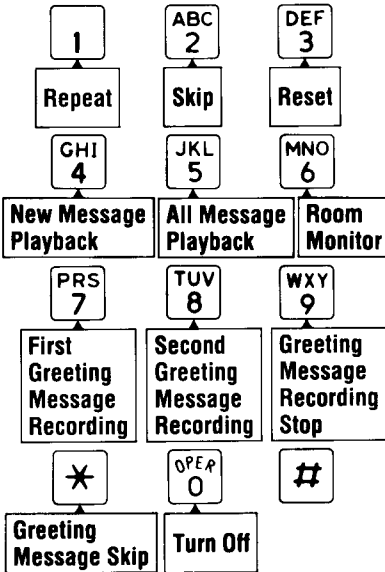

Call your unit.

Press remote code no. _____

- To playback all messages, press **5**.
- To playback new messages, press **4**.
- For repeat, press **1**.
- For skip, press **2**.
- To reset the tape after playback, press **3**.
- To save the messages, hang up after playback.

When you press a button, press firmly.

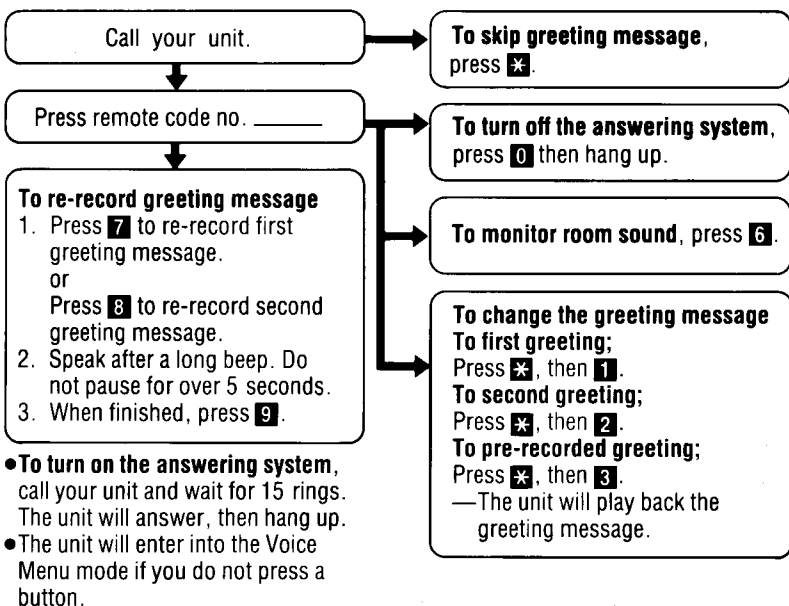

OPERATION FROM TONE PHONE

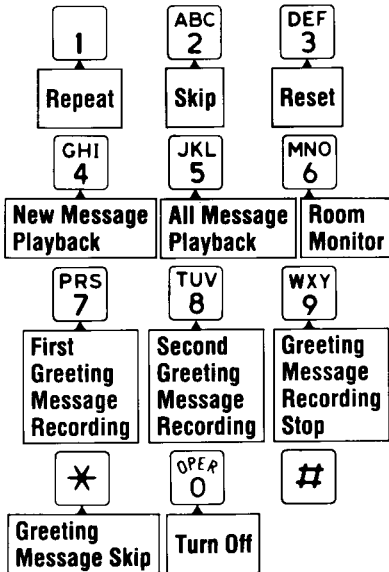

Call your unit.

Press remote code no. _____

- To playback all messages, press **5**.
- To playback new messages, press **4**.
- For repeat, press **1**.
- For skip, press **2**.
- To reset the tape after playback, press **3**.
- To save the messages, hang up after playback.

When you press a button, press firmly.

Call your unit.

Press remote code no. _____

To re-record greeting message

1. Press **7** to re-record first greeting message.
or
Press **8** to re-record second greeting message.
2. Speak after a long beep. Do not pause for over 5 seconds.
3. When finished, press **9**.

To skip greeting message,
press *****.

To turn off the answering system,
press **0** then hang up.

To monitor room sound, press **6**.

To change the greeting message
To first greeting;
Press *****, then **1**.
To second greeting;
Press *****, then **2**.
To pre-recorded greeting;
Press *****, then **3**.
—The unit will play back the
greeting message.

- **To turn on the answering system,** call your unit and wait for 15 rings. The unit will answer, then hang up.
- The unit will enter into the Voice Menu mode if you do not press a button.

Troubleshooting guide

PROBLEM

CAUSE & REMEDY

The unit does not work, and/or I cannot remove the tape from the unit.

—Plug in the AC adaptor again.

The answering system is on but no incoming messages are recorded.

—The REC TIME selector is set to the GREETING ONLY position. Change it to the VOX or 1 MIN position.

—The greeting message is recorded improperly or not recorded, so no one can leave a message. Check and record a new greeting message.

The call counter shows “Err”.

—The greeting message tape is not inserted. Insert the tape.

—The greeting message tape might be broken. Replace it with a new one.

6 quick beeps sound during greeting message recording, and it results in failure.

—Re-record your greeting message. Speak clearly and loudly, and do not pause for over 5 seconds while recording.

When a message is played back, the sound level is low, even if the volume is high.

—Clean the heads. (See page 45.)

—Replace the incoming message tape with a new one.

The unit does not answer remotely.

—The answering system is turned off. To set the unit to answer the call, call your unit and wait for 15 rings. (See page 38.)

PROBLEM**CAUSE & REMEDY**

I press the dial button of a touch tone phone after the unit answers, but the answering system does not respond.

- Make sure that you press your correct remote code number. To check your remote code number. (See page 30.)
- The answering system may not respond if a remote touch tone phone produces tones that are too short to activate the unit, so when you press any button, press firmly.

Some incoming messages have not been recorded up to the end.

- Program the CPC function to the “b” position. (See page 18.)

The incoming message tape continues to run after a caller hangs up.

- Set the REC TIME selector to the “1 MIN” position.

While operating the unit, the AC adaptor feels warm.

- This is a normal condition.

When you lift up the telephone handset to answer a call, the greeting is heard and it does not stop.

- Press the hookswitch on the telephone about one second. Then you can answer a call.

Maintenance

Tape deck

Since the head and capstan assemblies are in contact with the tape, dirt and residue from the tape may easily adhere to these parts, causing distortion. These parts should be cleaned periodically in the manner described below.

Clean the head surface, pinch roller and capstan with a cotton swab. If these surfaces are extremely dirty, wipe them with the cotton swab dampened with alcohol, then wipe them with a dry soft cloth.

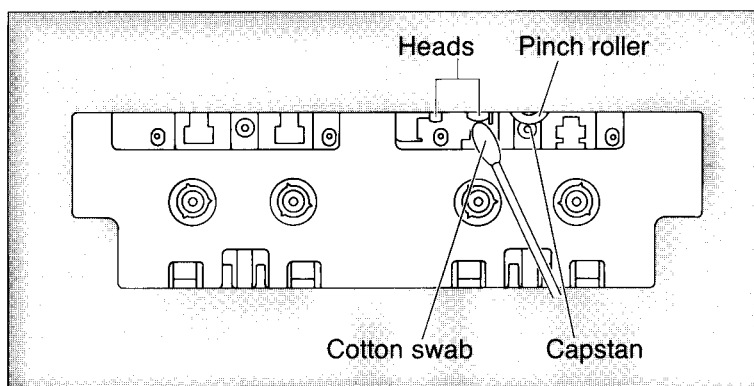

Notes:

- Do not bring magnetic or metal objects, such as a screwdriver, near the head assemblies, as such objects could magnetize the heads.
- Do not oil any part of the unit.

Cassette tape

- For optimum sound quality and performance, we recommend that you **use the opposite side (side-2) after six months and replace the tape with a new one every year**, assuming that the unit answers about ten calls a day.
- Never place a cassette tape near a magnetic source, such as a magnet or a TV set; because it may erase or distort the recorded message on the tape.
- Slack in the tape can be tightened by rotating the tape reel with an instrument like a pencil, as shown.

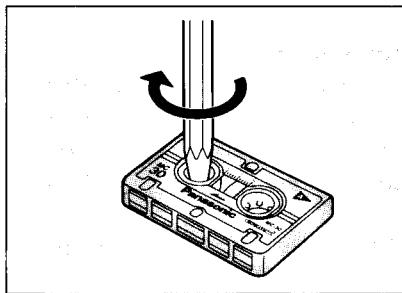

Cassette panel installation

If the panel comes off, replace it by pushing as shown.

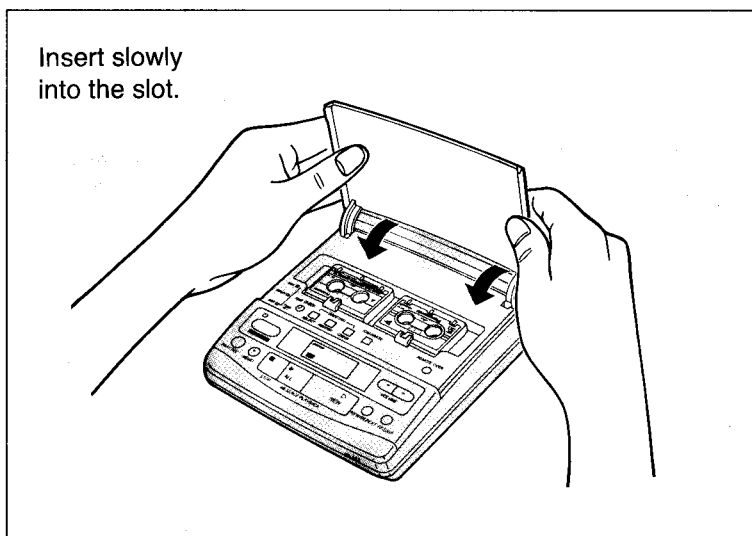

Important safety instructions ---

When using this unit, basic safety precautions as below should always be followed to reduce the risk of fire, electric shock, or personal injury.

1. Read and understand all instructions.
2. Follow all warnings and instructions marked on this unit.
3. Unplug this unit from wall outlets before cleaning. Do not use liquid or aerosol cleaners. Use a damp cloth for cleaning.
4. Do not use this unit near water, for example, near a bath tub, wash bowl, kitchen sink, or the like.
5. Install this unit securely on a stable surface. Serious damage may result if the unit falls.
6. Do not cover slots and openings of the unit, for they are provided for ventilation and protection against overheating. Never place the unit near radiators, in/or a place where proper ventilation is not provided.
7. Use only the power source as marked on the unit. If you are not sure of the type of the power supply to your home, consult your dealer or local power company.
8. Do not place objects on the power cord. Install the unit where no one can step on the cord.
9. Do not overload wall outlets and extension cords as this can result in the risk of fire or electric shock.
10. Never push any objects into this unit through slots as they may result in risk of fire or electric shock. Never spill any liquid on the unit.
11. To reduce the risk of electric shock, do not disassemble this unit, but take it to a qualified serviceman when some service or repair work is required. Opening or removing covers may expose you to dangerous voltages or other risks. Incorrect reassembly can cause electric shock when the appliance is subsequently used.
12. Unplug this unit from the wall outlet and refer servicing to qualified service personnel under the following conditions:
 - A. When the power supply cord or plug is damaged or frayed.
 - B. If liquid has been spilled into the unit.
 - C. If the unit has been exposed to rain or water.

- D. If the unit does not work normally by following the operating instructions. Adjust only controls covered by the operating instructions, for improper adjustment may require extensive work by a qualified technician.
 - E. If the unit has been dropped or damaged.
 - F. If the unit exhibits a distinct change in performance.
13. During thunderstorms, avoid using telephones except cordless types. There may be a remote risk of electric shock from lightning.
14. Do not use this unit to report a gas leak in the vicinity of it.

**SAVE THESE
INSTRUCTIONS**

INSTALLATION:

1. Never install telephone wiring during a lightning storm.
2. Never install telephone jacks in wet locations unless the jack is specifically designed for wet locations.
3. Never touch uninsulated telephone wires or terminals unless the telephone line has been disconnected at the network interface.
4. Use caution when installing or modifying telephone lines.

WARNING:

TO PREVENT FIRE OR SHOCK HAZARD, DO NOT EXPOSE THIS PRODUCT TO RAIN OR ANY TYPE OF MOISTURE.

FCC and other information

If requested by the telephone company, inform them as follows:
FCC registration No.

(found on the bottom of the unit)

Ringer Equivalence 0.2B

The particular telephone line to which the equipment is connected.

This unit must not be connected to a coin operated line.

If you are on a party line, check with your local telephone company.

Ringer Equivalence No. (REN):

The REN is useful in determining the quantity of devices you may connect to your telephone line and still have all of those devices ring when your telephone number is called.

In most, but not all areas, the sum of the REN's of all devices connected to one line should not exceed five (5.0).

To be certain of the number of devices you may connect to your line, as determined by the REN, you should contact your local telephone company to determine the maximum REN for your calling area.

In the event terminal equipment causes harm to the telephone network, the telephone company should notify the customer, if possible, that service may be stopped.

However, where prior notice is impractical, the company may temporarily cease service providing that they:

- (a) Promptly notify the customer.
- (b) Give the customer an opportunity to correct the problem with their equipment.
- (c) Inform the customer of the right to bring a complaint to the Federal Communication Commission pursuant to procedures set out in FCC Rules and Regulations Subpart E of Part 68.

The Telephone Company may make changes in its communications facilities, equipment, operations or procedures, where such action is reasonably required in the operation of its business and is not inconsistent with the rules and regulations in FCC Part 68.

If such changes can be reasonably expected to render any customer terminal equipment incompatible with telephone company communications facilities, or require modification or alteration of such terminal equipment, or otherwise materially affect its use or performance, the customer shall be given adequate notice in writing, to allow the customer an opportunity to maintain uninterrupted service.

CAUTION:

To assure continued compliance with FCC rules, do not make any unauthorized modifications.

Note:

This equipment has been tested and found to comply with the limits for a Class B digital device, pursuant to Part 15 of the FCC Rules. These limits are designed to provide reasonable protection against harmful interference in a residential installation. This equipment generates, uses, and can radiate radio frequency energy and, if not installed and used in accordance with the instructions, may cause harmful interference to radio

communications. However, there is no guarantee that interference will not occur in a particular installation. If this equipment does cause harmful interference to radio or television reception, which can be determined by turning the equipment off and on, the user is encouraged to try to correct the interference by one or more of the following measures:

- Reorient or relocate the receiving antenna.
- Increase the separation between the equipment and receiver.
- Connect the equipment into an outlet on a circuit different from that to which the receiver is connected.
- Consult the dealer or an experienced radio/TV technician for help.

- If there is any trouble, disconnect the unit from the telephone line and connect a known working phone. If the known working phone operates properly, have your unit repaired by one of the specified Panasonic Factory Service Centers. If the known working phone does not operate properly, consult with your telephone company.
- The unit should not be placed in room where the temperature is less than 5°C (41°F) or greater than 40°C (104°F).
- The unit should be situated so that the location or position does not interfere with its proper ventilation. Allow 10 cm (4") clearance around the unit.
- When the unit is not used, turn the power off. When left unused for long periods of time, the unit should be unplugged from the household AC outlet.
- Do not place heavy objects on top of this unit.
- Place the unit on a flat level surface. Damp basements should also be avoided.
- Do not subject this unit to excessive smoke, dust, mechanical vibration, shock, or direct sunlight.

Free Manuals Download Website

<http://myh66.com>

<http://usermanuals.us>

<http://www.somanuals.com>

<http://www.4manuals.cc>

<http://www.manual-lib.com>

<http://www.404manual.com>

<http://www.luxmanual.com>

<http://aubethermostatmanual.com>

Golf course search by state

<http://golfingnear.com>

Email search by domain

<http://emailbydomain.com>

Auto manuals search

<http://auto.somanuals.com>

TV manuals search

<http://tv.somanuals.com>