

Panasonic

900MHz Cordless Answering System

Model No. **KX-TC1891B**

Pulse-or-tone dialing capability

Operating Instructions



Preparation

Cordless Telephone

Answering System

Useful Information

2 LINE

**PLEASE READ BEFORE USE
AND SAVE.**

Caller ID Compatible

Charge the battery for about 6 hours before initial use.

**Panasonic World Wide Web address: <http://www.panasonic.com>
for customers in the USA or Puerto Rico**

Before Initial Use

Please read **IMPORTANT SAFETY INSTRUCTIONS** on page 92 before use.
Read and understand all instructions.

Thank you for purchasing your new Panasonic cordless telephone.

Caller ID and Call Waiting Service, where available, are telephone company services. After subscribing to Caller ID, this phone will display a caller's name and phone number. Call Waiting Caller ID, which displays a second caller's name and phone number while the user is on another call, requires a subscription to both Caller ID and Call Waiting.

Attach your purchase receipt here.

For your future reference







Serial No _____

Date of purchase _____

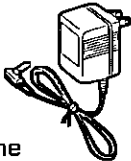
(found on the bottom of the unit)

Name and address of dealer _____

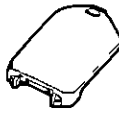
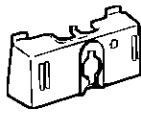
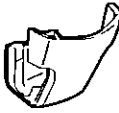
Accessories (included) For extra orders, call 1-800-332-5368

<input type="checkbox"/> AC Adaptor (p 13) Order No PQLV1Z  one	<input type="checkbox"/> 4-Wire Telephone Line Cord with Green Plugs (p 14, 15)  one	<input type="checkbox"/> 2-Wire Telephone Line Cord with Transparent Plugs (p 15)  one	<input type="checkbox"/> Battery (p 16) Order No P-P50B  one
<input type="checkbox"/> Handset Cover (p 16) Order No PQKK10099Z1  one	<input type="checkbox"/> Wall Mounting Adaptor (p 84) Order No PQKL10035Z1  one	<input type="checkbox"/> Handset Holder (p 84) Order No PQKE10097Z1  one	<input type="checkbox"/> Belt Clip (p 20) Order No PQKE10098Z1  one

For Best Performance

Battery Charge

A rechargeable Ni-Cd battery powers the handset. Charge the battery for about **6 hours** before initial use (p. 16)

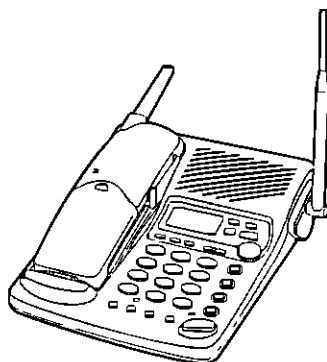

Base Unit Location/Noise

Calls are transmitted between the base unit and the handset using wireless radio waves. **For maximum distance and noise-free operation**, the recommended base unit location is

Away from electrical appliances such as a TV, personal computer or another cordless phone

In a **HIGH** and **CENTRAL** location with no obstructions such as walls

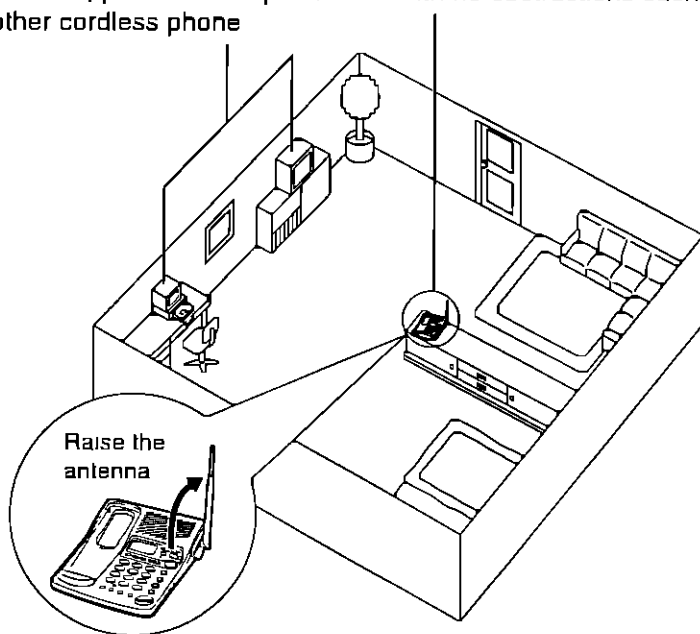

- If more than one cordless phone is being used and your handset is near another cordless phone's base unit, noise may be heard. Move away from the other cordless phone's base unit and closer to your base unit.

Contents

Preparation

Location of Controls	6
Displays	9
Settings	13
Connecting the AC adaptor	13
Connecting the Telephone Line Cord	14
Installing the Battery in the Handset	16
Battery Charge	16
Standby Mode	17
Selecting the Dialing Mode	18
Selecting the Line Mode	19
Using the Belt Clip	20
Using an Optional Headset	20
Programmable Functions	21
Setting the Auto Talk Feature	22
Selecting the Ringer Volume	23
Preparing the Answering System	25
Greeting Message	25
Programming Summary for the Answering System	27
Day and Time Adjustment	28
Selecting the Caller's Recording Time	30
Selecting the Number of Rings	31

Cordless Telephone

Making Calls	32
With the Handset	32
With the Base Unit (Digital Duplex Speakerphone)	35
Answering Calls	37
With the Handset	37
With the Base Unit	37
Caller ID Service	38
Using the Caller List	40
Viewing the Caller List	40
Calling Back from the Caller List	41
Editing the Caller's Phone Number	42
Storing Caller List Information in the Directory	44
Erasing Caller List Information	45
One-Touch Dialer	47
Storing a Phone Number in the DIRECT Button	47
Dialing the Stored Number in the DIRECT Button	48
Using the Directory	49
Storing Names and Numbers in the Directory	49
Steps for Entering Names and Symbols	51

Finding Items in the Directory	53
Dialing from the Directory	55
Editing an Item in the Directory	56
Erasing an Item from the Directory	57
Using the Other Line During a Conversation	58
While Someone Else is Using a Line (Simultaneous Base/Handset Calling)	58
While You are Using a Line	59
Conference Call	60
Intercom	61
Transferring a Call Using the Intercom	62
Special Features	63
Automatic Security Code Setting	63
Temporary Tone Dialing (For Rotary or Pulse Service Users)	63
How to Use the PAUSE Button (For Analog PBX Line/Long Distance Service Users)	64
For Call Waiting Service Users	64
FLASH Button	65
Line Selection	66
Incoming Call Tone	67

Answering System

Automatic Answering Operation	68
Setting the Unit to Answer Calls	68
Listening to Messages	70
From the Handset	72
Erasing Messages	73
Remote Operation from a Touch Tone Phone	74
Setting the Remote Code	75
Voice Menu	76
Direct Remote Operation	78
Remote Operation with the Handset	81

Useful Information

Wall Mounting	84
Battery Replacement	86
Adding Another Phone	86
Before Requesting Help	87
Important Safety Instructions	92
FCC and Other Information	94

Location of Controls

Base unit

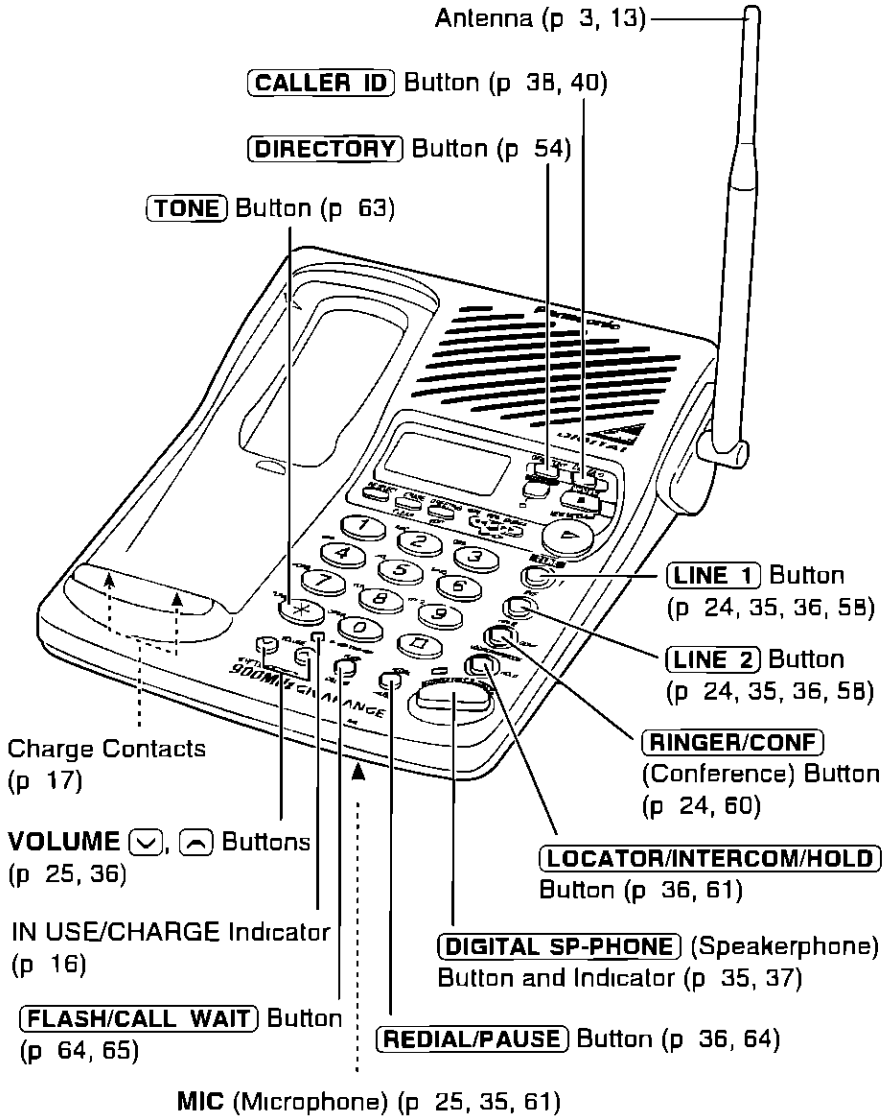

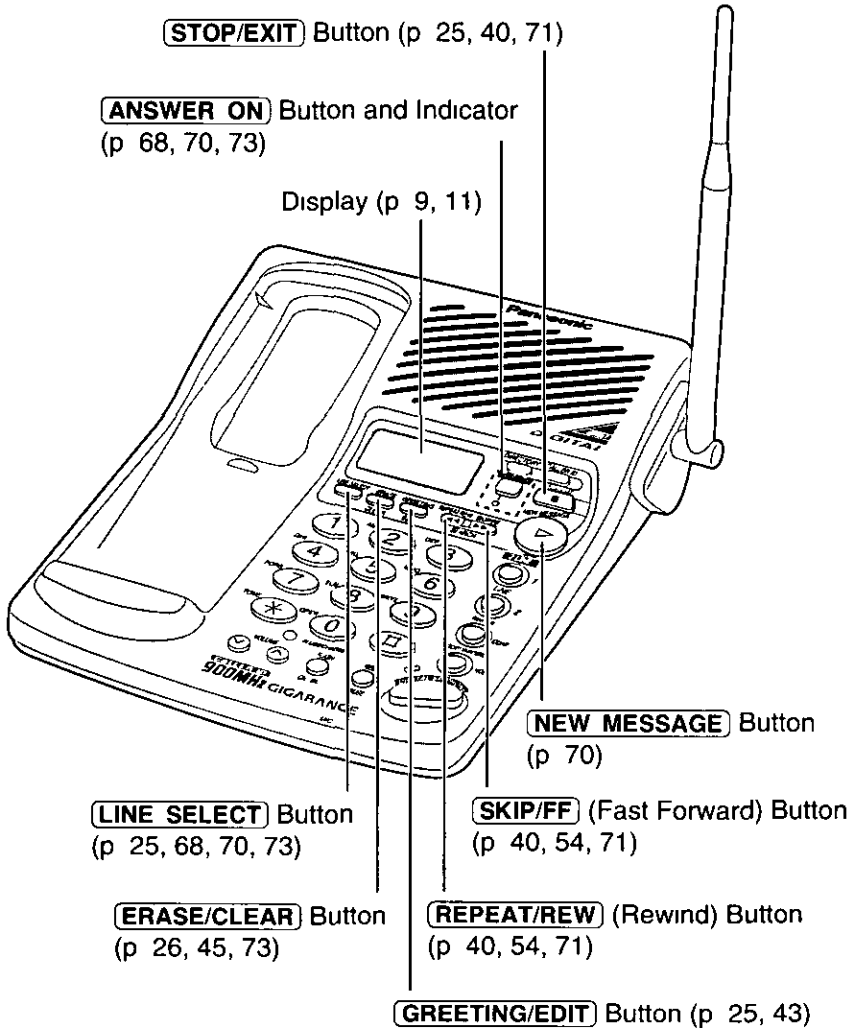

► Location of Controls

Handset

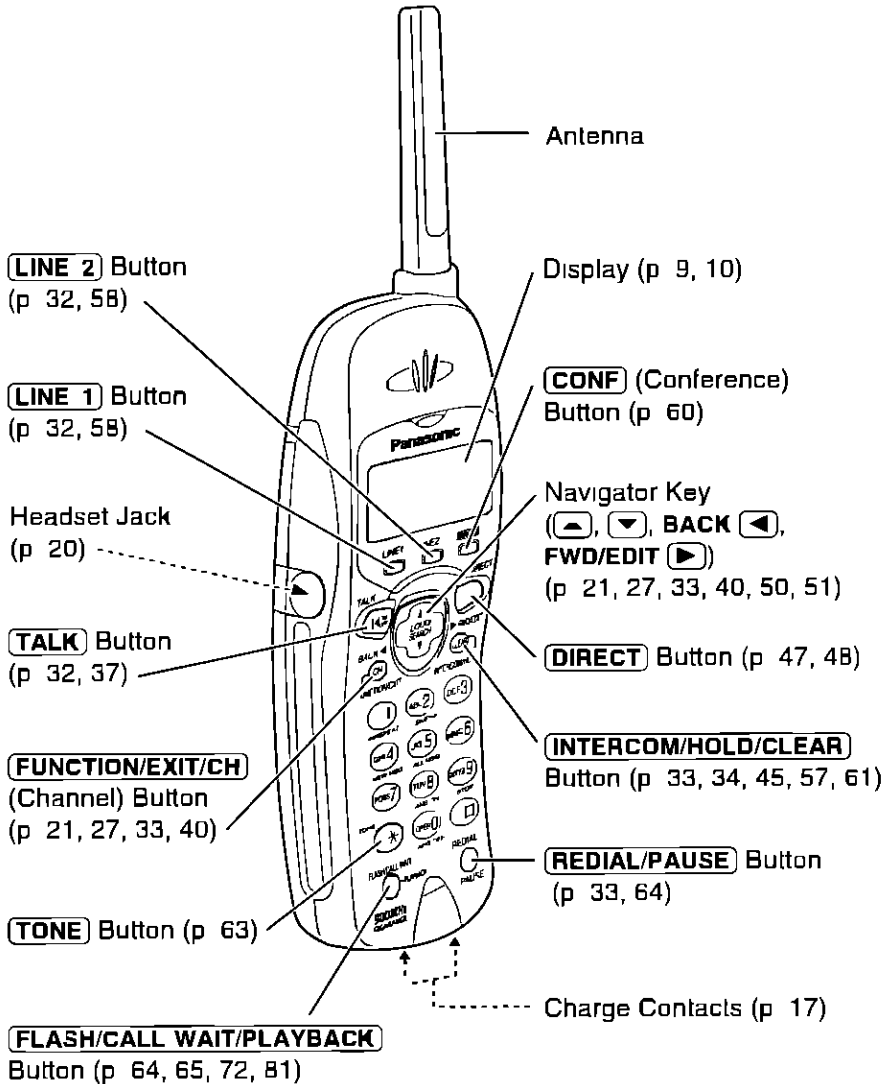

Displays



Both the handset and the base unit show you instructions and information on their displays. These display prompts are shown below.

(Handset display)

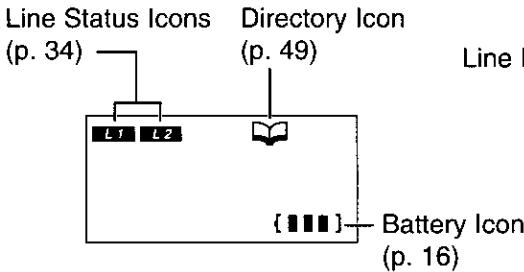

(Base unit display)

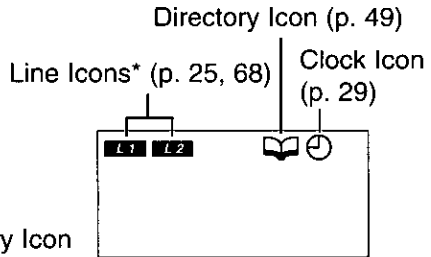

*The line icon(s) (“**L1**” and/or “**L2**”) will be displayed when you operate the answering system on the line(s).

Common prompts for the handset and the base unit

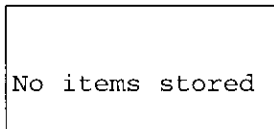

The Caller List for both lines is empty or there are no stored items in the directory.



When a call is received, the display shows the caller's name, number and the called line after the first ring. (The called line status icon flashes on the handset display.)

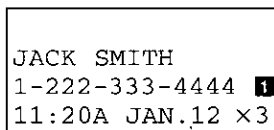

This is a name from the Caller List. The display shows:
—the caller's name,
—the caller's number and the called line,
—the time and date of the last call (ex. Jan. 12, 11:20 AM), and
—the number of times called (ex. 3 times).

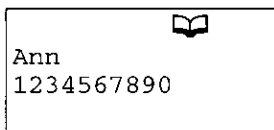

This is a name from the directory. The stored name and phone number are displayed.

(continued ▶)

► Displays

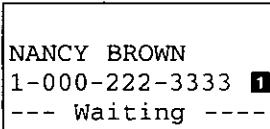

NANCY BROWN
1-000-222-3333 
--- Waiting ---

A second call is received during a conversation (p. 64).
(The called line status icon is displayed on the handset.)

Handset only

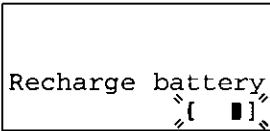

Recharge battery 

The battery needs to be charged. Place the handset on the base unit to charge the battery (p. 16).

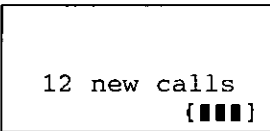



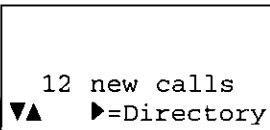

12 new calls
{■■■■}

The display shows the number of new calls and the battery strength (p. 16) while the handset is on the base unit.



12 new calls
▼▲ ▶=Directory

The display shows the number of new calls when  or  is pressed while the handset is off the base unit.

To search from the most recent call, press .
To search from the oldest call, press  (p. 40).
To go to the directory list, press **FWD/EDIT**  (Directory key).

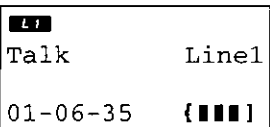

 Talk Line1
01-06-35 {■■■■}

During a conversation, the display shows the length of the call (ex. 1 hour, 6 minutes and 35 seconds). The battery strength is also displayed (p. 16).

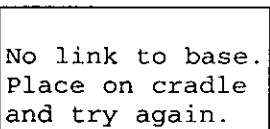



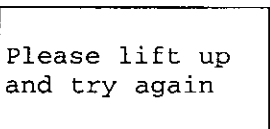

No link to base.
Place on cradle
and try again.

The handset has lost communication with the base unit. Place the handset on the base unit and try again.



Please lift up
and try again

, , **BACK**  or **FWD/EDIT**  was pressed while the handset was on the base unit. Lift the handset and press the button again.

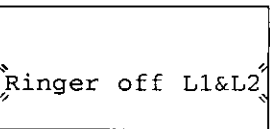

Ringer off L1&L2





When the ringer volume is set to OFF for both lines (p. 23), "Ringer off L1&L2" will flash for about 45 seconds before the unit returns to the standby mode (p. 17).



Directory full

When trying to store an item or Caller List information in the directory, the directory memory is full (p 44, 50)

Not available

, , **BACK**  or **FWD/EDIT**  was pressed while the base unit was not in the standby or speakerphone mode

Answering system setting
See base unit

The unit is in answering system programming mode (p 27)

Remote operation

The handset is operating the answering system remotely (p 81)

Save error

During a programming procedure, the handset has lost communication with the base unit. Move closer to the base unit

Base unit only

SUN 12 00AM
5 new calls
10 messages

In the standby mode, the display shows the current day and time, the number of new calls and recorded messages for both lines (Ex 5 new calls have been received and 10 messages have been recorded for both lines)

SUN 12 00AM
5 new calls
10 messages

The line icon will flash
—when the answering system is operating on a call,
—when the recorded messages on that line are being played

(continued )

► Displays

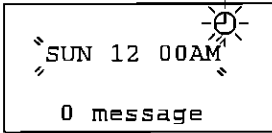

When the clock needs adjusting, the day and time flash (p 28, 29)



This display will be shown when **CALLER ID** is pressed To search from the most recent call, press **SKIP/FF** (New key) To search from the oldest call, press **REPEAT/REW** (old key) (p 40)

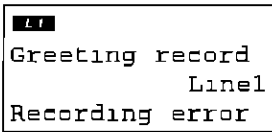

Your greeting message was not recorded correctly Record it again (p 25)

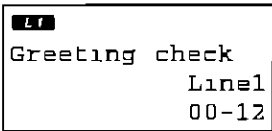

A greeting message is being played (p 26)
The display shows the elapsed time

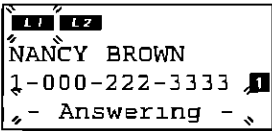

The answering system is recording a message (p 68) (" - Answering -" flashes)
When the answering system is turned on, the corresponding line icon will flash

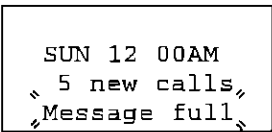

Message memory is full ("Message full" flashes) Erase some or all of the messages (p 73)

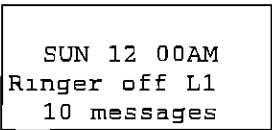

The ringer volume is set to OFF (p 24)

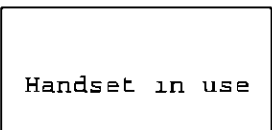

This display will be shown when the handset is used (viewing the Caller List or directory list, programming, etc)



Connecting the AC Adaptor

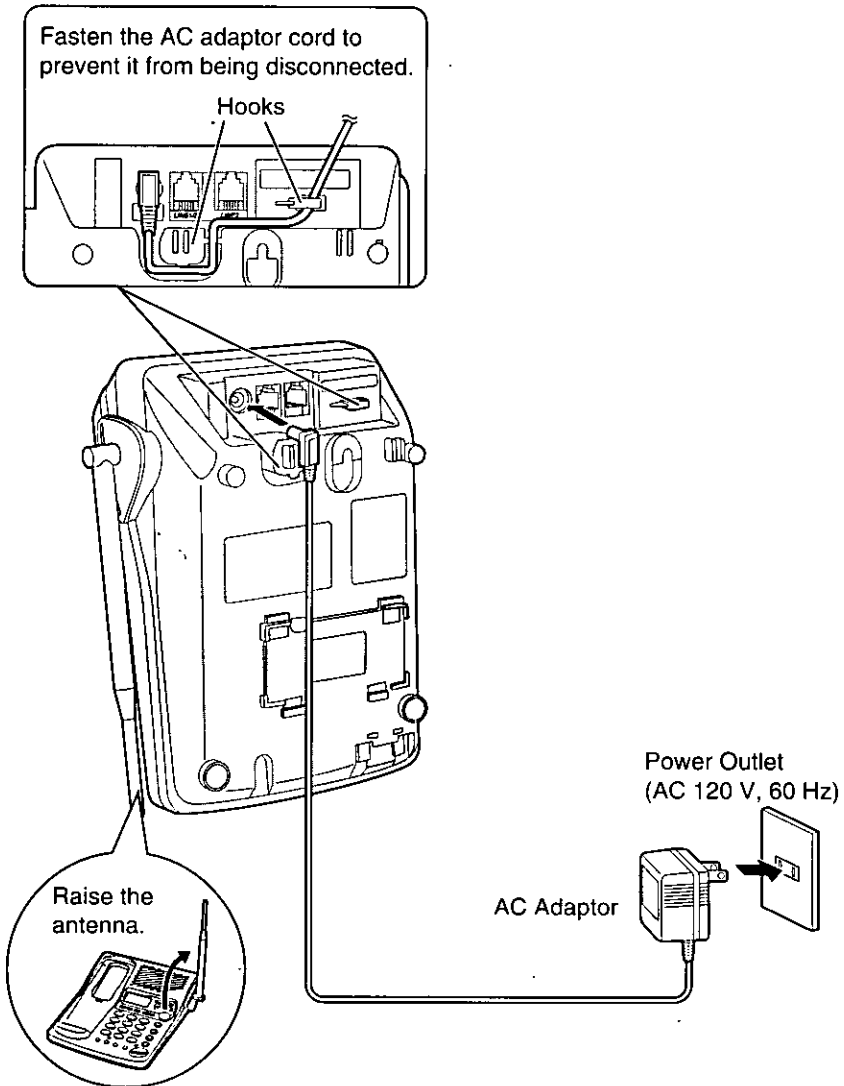

- USE ONLY WITH Panasonic AC ADAPTOR PQLV1 (Order No. PQLV1Z).
- The AC adaptor must remain connected at all times. (It is normal for the adaptor to feel warm during use.)
- To connect a standard telephone on the same line, see page 86.
- If your unit is connected to a PBX which does not support Caller ID services, you cannot access those services.

Connecting the Telephone Line Cord

Connect the telephone line cord(s) to the unit as follows

To connect a two-line telephone jack

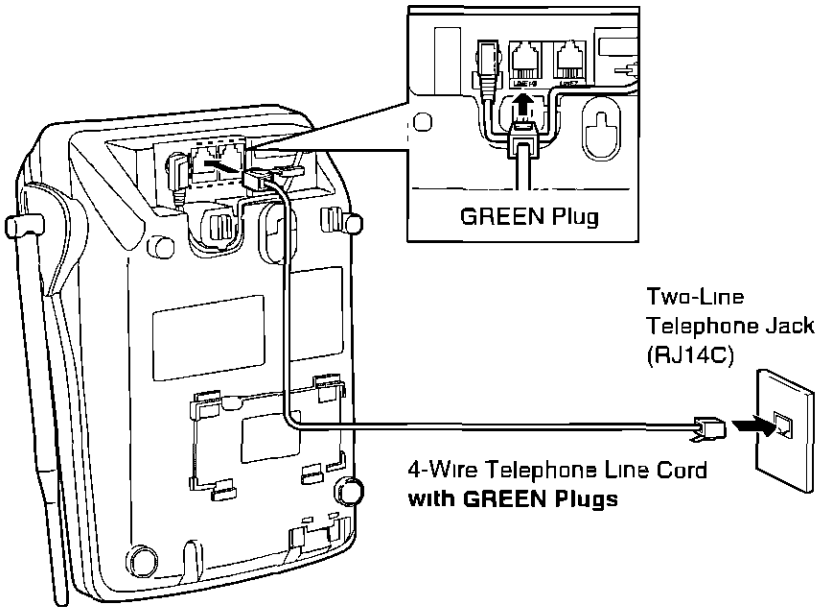



To connect two single-line telephone jacks

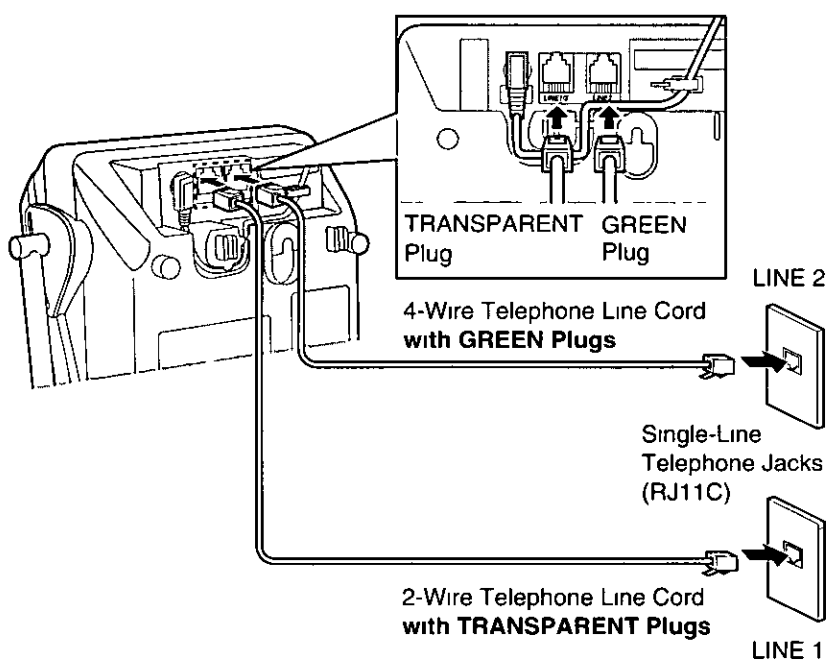

If you use the unit as a single-line telephone only

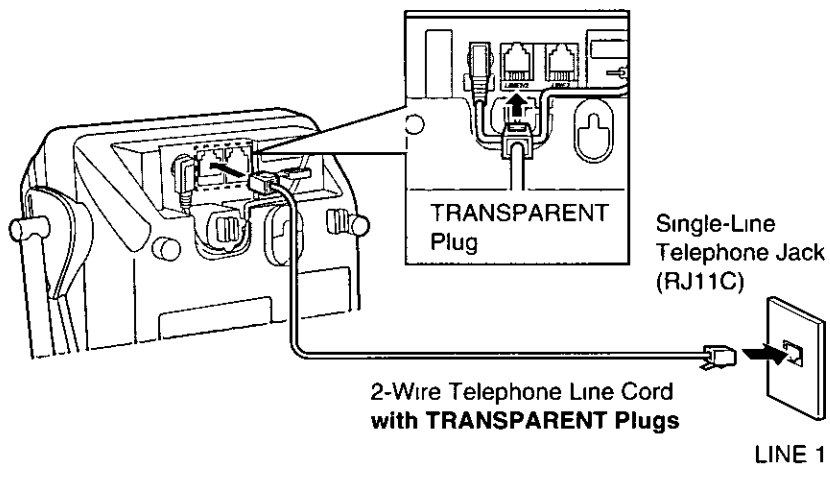

► Settings

Installing the Battery in the Handset

Install the battery and close the handset cover, locking it into place

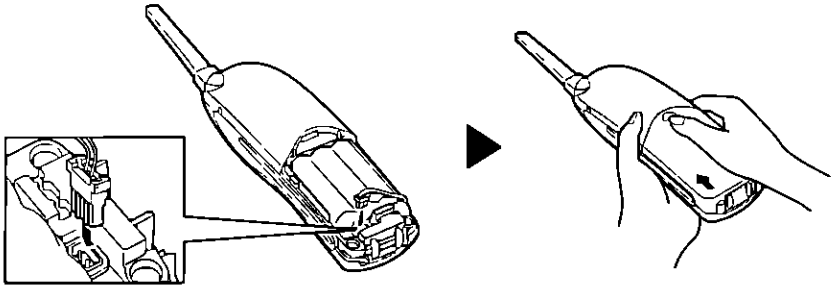

Battery Charge

Place the handset on the base unit and charge for about **6 hours** before initial use

- The IN USE/CHARGE indicator lights

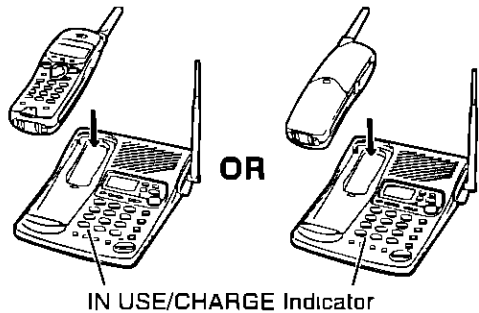

Battery strength

You can check the battery strength on the display while the handset is on the base unit, while it is in use (making/answering a call etc), or after viewing the Caller List or directory items, programming etc
The battery strength will remain on the display for a few seconds after using the handset, then the display will return to the standby mode (see next page)

The battery strength is as shown in the chart below

Display prompt	Battery strength
[■■■]	Fully charged
[■■]	Medium
[■]	Low
⚡ [■] ⚡ (flashing)	Needs to be recharged



Recharge

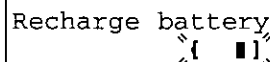

Recharge the battery when

- “Recharge battery” is displayed,
- “{ ■ }” flashes on the display, or
- the handset beeps intermittently while it is in use

- If you DO NOT recharge the handset battery for more than 15 minutes, the display will keep indicating “Recharge battery” and/or “{ ■ }” will continue to flash

Battery information

After your Panasonic battery is fully charged (p 16)

Operation		Approx. battery life
While in use (TALK)	near the base unit*	Up to about 6 hours
	away from the base unit	Up to about 4 hours
While not in use (Standby)		Up to about 14 days

*Within about 10 feet (3 m)

- Battery life may be shortened depending on usage conditions, such as viewing the Caller ID Caller List or directory list, and ambient temperature
- Clean the handset and the base unit charge contacts with a soft, dry cloth once a month. Clean more often if the unit is subject to grease, dust or high humidity.** Otherwise the battery may not charge properly
- If the battery is fully charged, you do not have to place the handset on the base unit until “Recharge battery” is displayed and/or “{ ■ }” flashes. This will maximize the battery life
- The battery cannot be overcharged

Standby Mode

Handset (While off the base unit)

The handset goes into the standby mode after you finish using the handset (making/answering a call, viewing the Caller List or directory list etc). The display is blank, but the handset can receive calls. The battery life is conserved in this mode.

Base Unit

The base unit goes into the standby mode after you finish using the base unit (making/answering a call, using the intercom, using the answering system etc). Programming is possible **only when** the base unit is in the standby mode.

► Settings

Selecting the Dialing Mode

If you have touch tone service, set to "Tone" If rotary or pulse service is used, set to "Pulse" Your phone comes from the factory set to "Tone"
Make sure the unit is in the standby mode

1 Press **FUNCTION/EXIT/CH**

```
►Save directory
Ringer volume
▼▲ ▶=Yes
```

2 Press **▼** or **▲** repeatedly until the arrow points to "Program"

```
►Program
▼▲ ▶=Yes
```

3 Press **FWD/EDIT** **▶** (Yes key)

```
►Save DIRECT#
Set flash time
▼▲ ▶=Yes
```

4 Press **▼** or **▲** repeatedly until the arrow points to "Set dial mode"

```
Set line mode
►Set dial mode
▼▲ ▶=Yes
```

5 Press **FWD/EDIT** **▶** (Yes key)

```
Dial mode
Tone
▼▲ ▶=Save
```

6 Press **▼** or **▲** to select "Pulse" or "Tone" Press **FWD/EDIT** **▶** (Save key)

```
Dial mode
Pulse
```

- A beep sounds
- To return to the standby mode, press **FUNCTION/EXIT/CH**

- You can exit the programming mode any time by pressing **FUNCTION/EXIT/CH**
- If either line has rotary or pulse service, set to "Pulse" When making a call using a line which has touch tone service, press **(TONE)** first and then dial the number



Selecting the Line Mode

If the line is connected to a low voltage system such as a PBX, set to "B"
Otherwise the **TALK** and/or **DIGITAL SP-PHONE** button(s) may not operate properly Both lines are preset to "A"
Make sure the unit is in the standby mode.

1 Press **FUNCTION/EXIT/CH**

```
▶Save directory
  Ringer volume
▼▲ ▶=Yes
```

2 Press ▼ or ▲ repeatedly until the arrow points to "Program"

```
▶Program
▼▲ ▶=Yes
```

3 Press **FWD/EDIT** ▶ (Yes key)

```
▶Save DIRECT#
  Set flash time
▼▲ ▶=Yes
```

4 Press ▼ or ▲ repeatedly until the arrow points to "Set line mode"

```
▶Set line mode
  Set dial mode
▼▲ ▶=Yes
```

5 Press **FWD/EDIT** ▶ (Yes key)

```
Line mode
▼=Line1 ▲=Line2
```

6 Press ▼ (Line1) or ▲ (Line2) to select the desired line

```
Line mode
  Line1 A
▼▲ ▶=Save
```

7 Press ▼ or ▲ to select "B" or "A"
Press **FWD/EDIT** ▶ (Save key)

```
Line mode
  Line1 B
```

- A beep sounds
- To program the other line, start again from step 4
- To return to the standby mode, press **FUNCTION/EXIT/CH**

•You can exit the programming mode any time by pressing **FUNCTION/EXIT/CH**

► Settings

Using the Belt Clip

You can hang the handset on your belt or pocket using the belt clip

To attach the belt clip

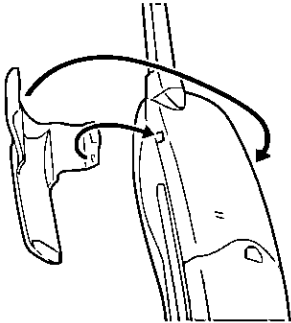

To remove the belt clip



Using an Optional Headset

Plugging an optional headset into the handset allows a hands-free phone conversation. Please use only a Panasonic KX-TCA87 or KX-TCA90 headset. To order, call the accessories telephone number on page 2.

Connecting the headset to the handset

Open the headset jack cover, and connect the headset to the headset jack as shown below.

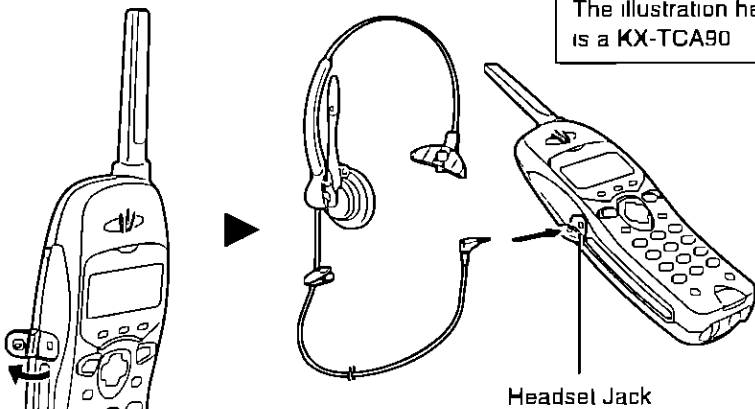

When the headset is connected to the handset, make sure to use the headset to talk with the caller. If you want to have a normal cordless phone conversation, disconnect the headset.

Programmable Functions



You can program the following function items **using the handset near the base unit**. The display shows the programming instructions. See the corresponding pages for function details.

Make sure the unit is in the standby mode

Press **FUNCTION/EXIT/CH**



<Function menu>*

- ▶ Save directory
- Ringer volume
- Program

To store an item in the directory (p 50)
To select the ringer volume (p 23)

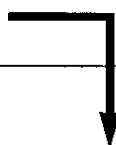

Press **FWD/EDIT**

<Function menu>*

- ▶ Save DIRECT#
- Set flash time
- Set line mode
- Set dial mode
- Line selection
- Incoming call
- Talk switching
- TAD program

To store a phone number in the DIRECT button (p 47)
To select the flash time (p 65)
To select the line mode (p 19)
To select the dial mode (p 18)
To change the line selection (p 66)
To set the incoming call tone (p 67)
To set the auto talk feature (p 22)
To program answering system functions (p 27)

During programming

*To select a desired function item, press or repeatedly until the arrow points to the item. Then press **FWD/EDIT** to go to the next step.

- If the handset displays "No link to base Place on cradle and try again" and an alarm tone sounds, move closer to the base unit and try again.
- You can exit the programming mode any time by pressing **FUNCTION/EXIT/CH**.
- If you do not press any buttons for 60 seconds, the unit will return to the standby mode.



► Programmable Functions

Setting the Auto Talk Feature

The Auto Talk feature allows you to answer a call by lifting the handset off the base unit without pressing **TALK**. If you want to use this feature, turn the feature ON by programming. Your phone comes from the factory set to OFF.

Make sure the unit is in the standby mode

1 Press **FUNCTION/EXIT/CH**

2 Press  or  repeatedly until the arrow points to "Program"

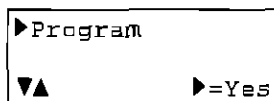

3 Press **FWD/EDIT**  (Yes key)

4 Press  or  repeatedly until the arrow points to "Talk switching"

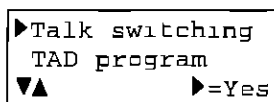

5 Press **FWD/EDIT**  (Yes key)

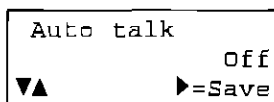

6 Press  or  to select "On" or "Off"
Press **FWD/EDIT**  (Save key)

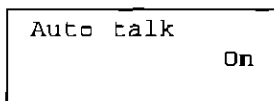

- A beep sounds
- To return to the standby mode, press

FUNCTION/EXIT/CH

- You can exit the programming mode any time by pressing **FUNCTION/EXIT/CH**
- To answer a call when the Auto Talk feature is OFF, lift the handset off the base unit and press **TALK**



Selecting the Ringer Volume

You can program the ringer volume to HIGH, LOW or OFF. If set to OFF, the unit will not ring. Your phone comes from the factory set to HIGH.

Make sure the unit is in the standby mode.

With the handset

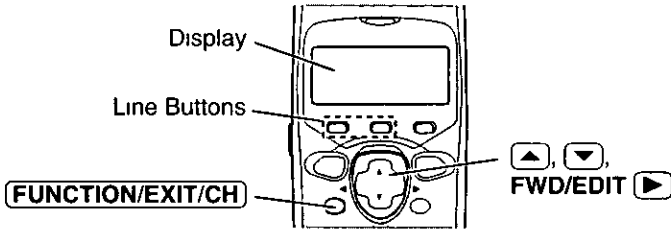

- 1 Press **FUNCTION/EXIT/CH**
- 2 Press **▼** or **▲** repeatedly until the arrow points to "Ringer volume"
- 3 Press **FWD/EDIT** (Yes key)
- 4 Press **▼** (Line1) or **▲** (Line2) to select the desired line
- 5 Press **▼** or **▲** to select the desired volume

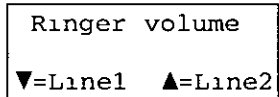
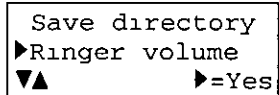

- The selected volume is displayed and rings
- The handset will return to the standby mode
- To turn the ringer OFF,** press and hold **▼** until 2 beeps sound
- To turn the ringer ON,** press **▲** or **▼**
 - The ringer for the selected line will sound at the LOW level

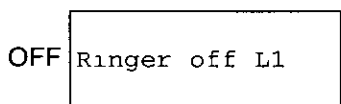
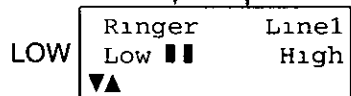
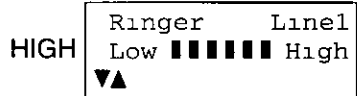

•When you replace the battery, the selected ringer volume setting will return to the factory set (HIGH). Reprogram if necessary.

► Programmable Functions

With the base unit

■ To select HIGH (preset) or LOW

- 1 Press **RINGER/CONF**
 - Both line buttons will flash
- 2 Press **LINE 1** or **LINE 2** to select the desired line
 - Each time you press the line button, the ringer volume will change and the selected volume will ring

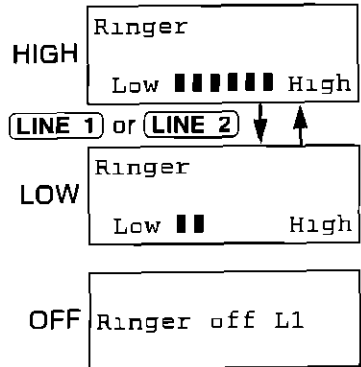

■ To turn the ringer OFF

- 1 Press **RINGER/CONF**
- 2 Press and hold **LINE 1** or **LINE 2** until 2 beeps sound

■ To turn the ringer ON

Press **RINGER/CONF** and then **LINE 1** or **LINE 2**

- The ringer for the selected line will sound at the HIGH level

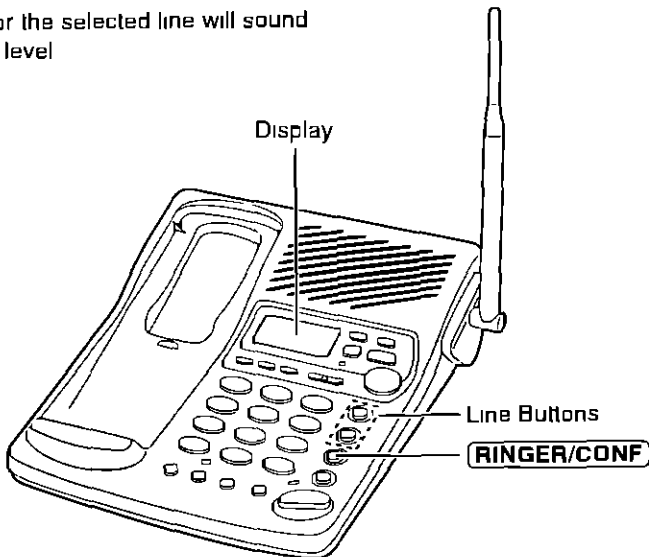

Preparing the Answering System

Greeting Message

You can record a personal greeting message of **up to 2 minutes** for each line or a common greeting message for both lines. If a greeting message is not recorded, one of two pre-recorded greetings will be played when a call is received (p. 26)

All messages (greeting, incoming, etc.) are stored in digital memory (p. 26). The **total recording time is about 15 minutes**. We recommend you record a **brief greeting message** (see sample on next page) in order to leave more time for recording new messages.

To record a greeting message

- To record a common greeting, press **LINE SELECT** repeatedly until "**L1**" or "**L2**" is displayed.
 - To record a greeting for each line, press **LINE SELECT** repeatedly until "**L1**" or "**L2**" is displayed.

- Press and hold **GREETING/EDIT** until a long beep is heard.

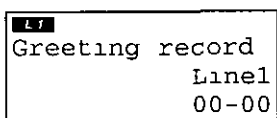

- Talk clearly, about 8 inches (20 cm) away from the **MIC** (microphone).

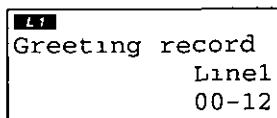

- The base unit display shows the elapsed recording time.
- If you record for over 2 minutes, the unit will automatically stop recording.

- When finished, press **STOP/EXIT**.
 - To change the message, start again from step 1.

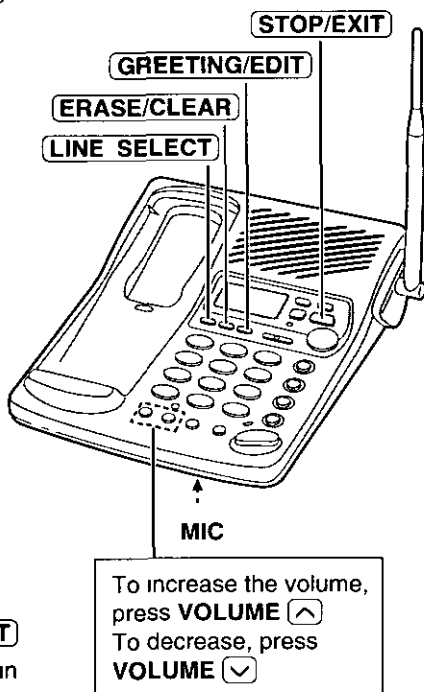

► Preparing the Answering System

Greeting message sample

"Hello, this is (your name and/or number) Sorry I cannot take your call Please leave a message after the beep Thank you "

To check the greeting message(s)

Press **(LINE SELECT)** repeatedly to select the desired line(s), then press **(GREETING/EDIT)** briefly

- The selected greeting(s) is (are) played back
- When both lines are selected, the LINE 1 greeting will be played first

To erase the recorded greeting message

Press **(LINE SELECT)** repeatedly to select the desired line(s), then press **(GREETING/EDIT)** briefly Press **(ERASE/CLEAR)** while the message is being played

- The unit will answer a call with a pre-recorded greeting for the relevant line(s)
- If you record a greeting for each line, you cannot erase those greetings at one time, even if you select both lines when erasing Only the greeting message which is being played can be erased

Pre-recorded greeting message

If you do not record a greeting message (p 25), one of two messages will be played when a call is received, depending on the caller's recording time (p 30)

To check the pre-recorded greeting, press **(GREETING/EDIT)** briefly

- A pre-recorded greeting will be played as follows
- When the recording time is set to "1 minute" or "3 minutes"
'Hello, we are not available now Please leave your name and phone number after the beep We will return your call '
- When the recording time is set to "Greeting only"
' Hello, we are not available now Please call again Thank you for your call ''

Flash Memory Message Backup

Messages are stored on a "flash memory" IC chip and will not be affected by power failures All messages are saved until you erase them



Programming Summary for the Answering System

You can program the following functions **using the handset near the base unit** See the corresponding pages below for details
The unit must be in the standby mode before programming.

Lift the handset, and press **FUNCTION/EXIT/CH**



Press **▼** or **▲** to select "Program", and press **FWD/EDIT** **▶** (Yes key)



Press **▼** or **▲** to select "TAD program", and press **FWD/EDIT** **▶** (Yes key)
● "Answering system setting See base unit " is displayed on the handset



● If the handset displays "No link to base Place on cradle and try again " and an alarm tone sounds, move closer to the base unit and try again

To adjust the **day and time**, press **0** (page 28)
To set the **remote code**, press **1** (page 75)
To select the **number of rings**, press **2** (page 31)
To select the **caller's recording time**, press **5** (page 30)
● The base unit display shows the setting of the selected adjustment or function









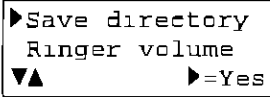

Press **FWD/EDIT** **▶** (Save key)
● A beep sounds
● To return to the standby mode, press **FUNCTION/EXIT/CH**

- To cancel during programming, press **FUNCTION/EXIT/CH** Start again from the beginning
- If 6 beeps sound during programming, a wrong key was pressed Enter the correct number

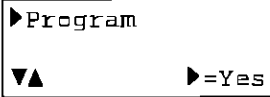

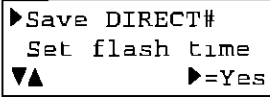
► Preparing the Answering System

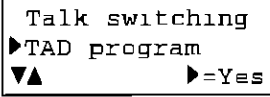
Day and Time Adjustment

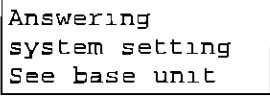
Voice Day/Time Stamp. During playback, a synthesized voice will announce the day and time that each message was recorded

- 1 Press **FUNCTION/EXIT/CH**

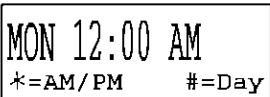
- 2 Press  or  repeatedly until the arrow points to "Program"

- 3 Press **FWD/EDIT**  (Yes key)

- 4 Press  or  repeatedly until the arrow points to "TAD program"

- 5 Press **FWD/EDIT**  (Yes key)
 - The base unit display shows the answering system function menu
- 6 Press **0**
 - "Set time" is announced
 - If previously adjusted, the day/time will be heard

Base unit display

- 7 Enter the current time (hour and minute) using a 4-digit number (Ex To set 9 30, enter "0930")
- 8 Press ***** to select "AM" or "PM"
Press **#** repeatedly to set the day
- 9 Press **FWD/EDIT**  (Save key)
 - The unit announces the day/time
 - The clock starts working
 - To return to the standby mode, press **FUNCTION/EXIT/CH**



- In step 7, you cannot enter numbers greater than 12 **Do not use military time** (To set 13 00 hours, enter "0100" and select "PM" by pressing **[*]**)

If a power failure occurs, "⊖" will flash or the incorrect day/time will be shown on the main unit display Reprogram the current day/time

To check the day/time

Repeat steps 1 to 6 on page 28

- The current day/time is heard When finished, press **[FUNCTION/EXIT/CH]**

For Caller ID service users (p 38)

- The Caller ID information will re-set the clock after the first ring if the adjusted time is incorrect However, the day will not be re-set by the Caller ID information Adjust the correct day by following the steps on page 28
- If the time has not previously been set, the Caller ID information will not adjust the clock
- The Caller ID information will automatically adjust the clock for daylight saving time

► Preparing the Answering System

Selecting the Caller's Recording Time

You can select "1 minute", "3 minutes" or "Greeting only" for the caller's recording time. Your phone comes from the factory set to "3 minutes".

- 1 Press **FUNCTION/EXIT/CH**

▶Save directory
Ringer volume
▼▲ ▶=Yes
- 2 Press **▼** or **▲** repeatedly until the arrow points to "Program"

▶Program
▼▲ ▶=Yes
- 3 Press **FWD/EDIT** **▶** (Yes key)

▶Save DIRECT#
Set flash time
▼▲ ▶=Yes
- 4 Press **▼** or **▲** repeatedly until the arrow points to "TAD program"

Talk switching
▶TAD program
▼▲ ▶=Yes
- 5 Press **FWD/EDIT** **▶** (Yes key)
 - The base unit display shows the answering system function menu

Answering
system setting
See base unit
- 6 Press **5**
- 7 To select LINE 1, press **1**
To select LINE 2, press **2**
 - The current setting of the selected line is displayed on the base unit

Base unit display
Recording time
1=Line1 2=Line2
- 8 Press **1**, **2** or **3** to select the recording time
 - 1 1 minute
 - 2 3 minutes (factory preset)
 - 3 Greeting only

Base unit display
Recording time
Line1 3min
- 9 Press **FWD/EDIT** **▶** (Save key)
 - A beep sounds
 - To program the other line, start again from step 4
 - To return to the standby mode, press **FUNCTION/EXIT/CH**

If you select "Greeting only", the unit will answer a call with the greeting message, and then hang up. The unit will not record any incoming messages.

Selecting the Number of Rings

You can select the number of times the unit rings before the answering system answers a call, from "2" to "7" or "Toll saver"
Your phone comes from the factory set to "Toll saver"

1 Press **FUNCTION/EXIT/CH**

▶Save directory
Ringer volume
▼▲ ▶=Yes

2 Press ▼ or ▲ repeatedly until the arrow points to "Program"

▶Program
▼▲ ▶=Yes

3 Press **FWD/EDIT** ▶ (Yes key)

▶Save DIRECT#
Set flash time
▼▲ ▶=Yes

4 Press ▼ or ▲ repeatedly until the arrow points to "TAD program"

Talk switching
▶TAD program
▼▲ ▶=Yes

5 Press **FWD/EDIT** ▶ (Yes key)

- The base unit display shows the answering system function menu

Answering system setting
See base unit

6 Press **2**

7 To select LINE 1, press **1**
To select LINE 2, press **2**

- The current setting of the selected line is displayed on the base unit

Base unit display

Number of rings
1=Line1 2=Line2

8 Press **0**, or **2** to **7** to set the number of rings

- 0 Selects "Toll saver"
- 2-7 The unit will answer after the selected number of rings

Base unit display

Number of rings
Line1 Toll saver

9 Press **FWD/EDIT** ▶ (Save key)

- A beep sounds
- To program the other line, start again from step 4
- To return to the standby mode, press **FUNCTION/EXIT/CH**

*Toll saver

When you call the unit from a touch tone telephone

If the unit answers on the 2nd ring, there is at least one new message

If the unit answers on the 4th ring, there are no new messages

Hang up when you hear the 3rd ring This will save you the toll charge for the call

Making Calls

With the Handset

To have a hands-free conversation, connect an optional headset to the handset (p 20)

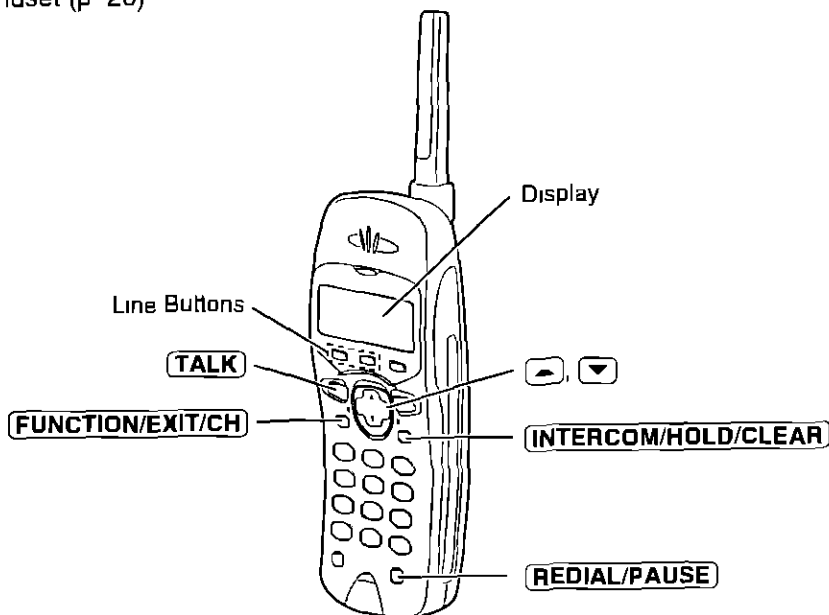

- 1 Press **TALK**
 - A free line is automatically selected and the line status icon is displayed
 - To change the line selection, see page 66
- 2 Dial a phone number
 - The dialed number is displayed
 - After a few seconds, the display will show the length of the call and the battery strength
- 3 To hang up, press **TALK** or place the handset on the base unit
 - The line status icon goes out

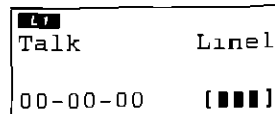
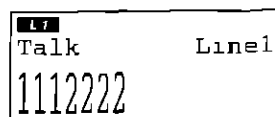
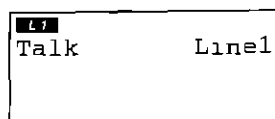

- If "No link to base Place on cradle and try again" is displayed and an alarm tone sounds in step 1, move closer to the base unit or place the handset on the base unit, and try again
- To switch a call from the handset to the speakerphone, see page 35
- In step 1, you may select a line manually by pressing the line button instead of

TALK



If noise interferes with the conversation

Press **FUNCTION/EXIT/CH** to select a clearer channel or move closer to the base unit

To redial the last number dialed on the handset

Press **TALK** or a line button → **REDIAL/PAUSE**

To dial after confirming the entered number

- 1 Dial a phone number
- If you misdial, press **INTERCOM/HOLD/CLEAR** All digits are erased Dial the correct phone number

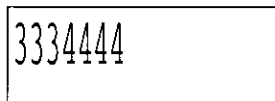

- 2 Press **TALK** or a line button
- After a few seconds, the display will show the length of the call and the battery strength

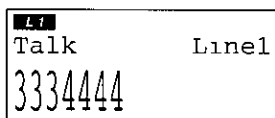

- 3 To hang up, press **TALK** or place the handset on the base unit

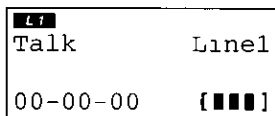

Cordless Telephone

To redial after confirming the last number dialed

Press **REDIAL/PAUSE** → **TALK** or a line button

To select the receiver volume

Press **▲** or **▼** while talking

- Each time you press **▲** or **▼**, the volume level will change
- The display will return to the length of the call
- Your phone comes from the factory set to MEDIUM
- When you replace the battery, the selected receiver volume setting will return to the factory set (MEDIUM) Reprogram if necessary

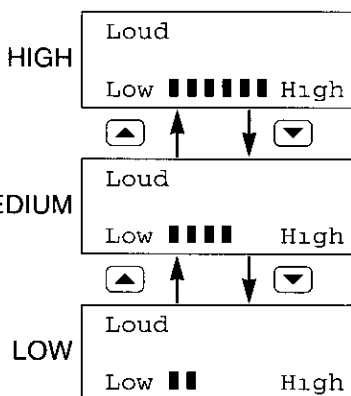

► Making Calls

To put a call on hold

Press **INTERCOM/HOLD/CLEAR**.

- “Hold” is displayed.
- The called line status icon on the handset and the called line button on the base unit flash.

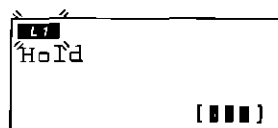

To release the hold

Press the line button on the handset whose status icon is flashing or the line button on the base unit which is flashing.

- If another phone is connected on the same line (p. 86), you can also release the hold by lifting its handset.

Backlit LCD display

The lighted handset display will stay on for about a few seconds after pressing a handset button, lifting the handset off the base unit, hanging up a call, leaving the programming mode or ending the intercom.

Lighted handset keypad

The handset dialing buttons will light when you press a button or lift the handset off the base unit, and flash when a call is received.

The lights will go out about a few seconds after pressing a button, lifting the handset, answering a call, hanging up a call, leaving the programming mode or ending the intercom.

What the line status icons (“**L1**” and “**L2**”) on the display mean (Handset)

Off	The line is free.
On	You are using the line on the handset, base unit or parallel connected telephone.
Flashing	A call is on hold. The answering system is operating on a call.
Flashing quickly	A call is being received.



With the Base Unit (Digital Duplex Speakerphone)

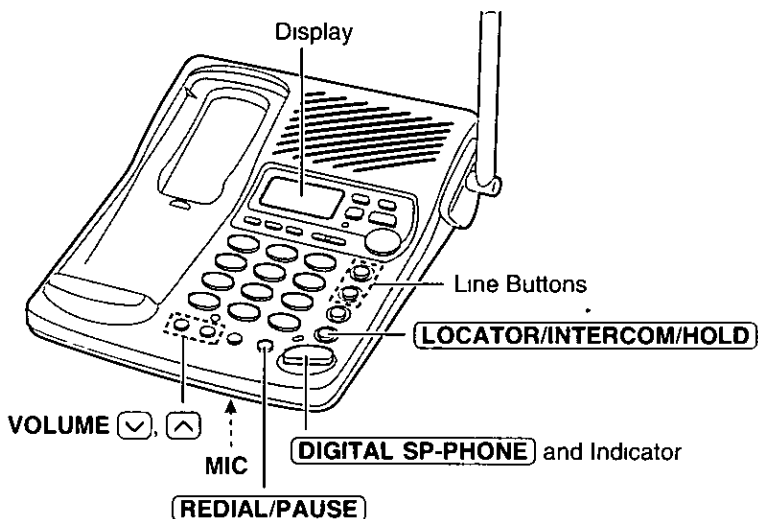

- 1** Press **DIGITAL SP-PHONE**
- The DIGITAL SP-PHONE indicator lights
 - A free line is automatically selected and the line button lights

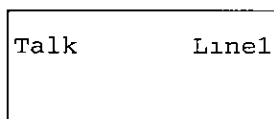

- 2** Dial a phone number
- After a few seconds, the display will show the length of the call

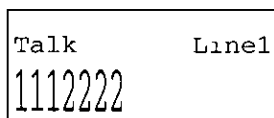

- 3** When the other party answers, talk into the **MIC** (microphone)

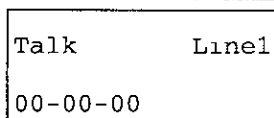



- 4** To hang up, press **DIGITAL SP-PHONE**
- The indicator and the line button lights go out

- To switch to the handset while using the speakerphone
 - If the handset is off the base unit, press the line button on the handset whose status icon is on
 - If on the base unit, just lift up
- During a call using the handset, the call can be switched to the speakerphone by pressing the base unit's line button for the line which is being used on the handset
- The line button shows the line status (see "What the line buttons mean" on page 36)
- In step 1, you may select a line manually by pressing the line button instead of **DIGITAL SP-PHONE**

► Making Calls

Hands-free Digital Speakerphone

For best performance, please note the following

- Talk alternately with the caller in a quiet room
- If the other party has difficulty hearing you, press **VOLUME**  to decrease the speaker volume
- If the other party's voice from the speaker cuts in/out during a conversation, press **VOLUME**  to decrease the speaker volume

To adjust the speaker volume (8 levels) while talking

To increase, press **VOLUME** 

To decrease, press **VOLUME** 

Loud

Low  High

To redial the last number dialed on the base unit

Press **DIGITAL SP-PHONE** or a line button → **REDIAL/PAUSE**

To put a call on hold

Press **LOCATOR/INTERCOM/HOLD**

- The **DIGITAL SP-PHONE** indicator goes out, and the called line button on the base unit and the called line status icon on the handset flash

Hold

To release the hold

Press the line button on the base unit which is flashing or the line button on the handset whose status icon is flashing

- If another phone is connected on the same line (p 86), you can also release the hold by lifting its handset

What the line buttons mean (Base unit)

Off	The line is free
On	You are using the line on the base unit
Flashing twice every 2 seconds	Someone else is using the line on the handset or parallel connected telephone
Flashing	A call is on hold The answering system is operating on a call
Flashing quickly	A call is being received

Answering Calls

When a call is received, the unit rings, "Incoming call" and the called line are displayed on the unit. The called line status icon on the handset and the called line button on the base unit flash quickly. The line is automatically selected when you answer the call. (To change the line selection, see page 66.)

If you subscribe to a Caller ID service, the calling party information will be displayed after the first ring (p. 38). In order to view the Caller ID information, please wait until the second ring to answer a call.

With the Handset

Lift the handset off the base unit and press

TALK.

- The called line status icon stops flashing.
- You can also answer a call by pressing any dialing button **0** to **9**, ***** or **#** (**Any Key Talk**).
- You may answer a call by pressing the line button instead of **TALK**.
- When the ringer volume is set to "OFF", the selected line(s) will not ring (p. 23).

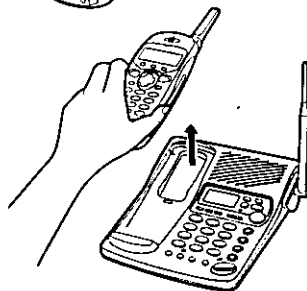
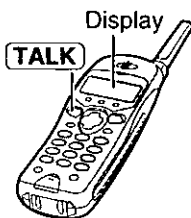

Auto Talk

If you set the Auto Talk feature to ON (p. 22), you can answer a call by lifting the handset off the base unit without pressing **TALK**.

When the headset is connected (p. 20), make sure to use the headset to talk with the caller. If you want to have a normal cordless phone conversation, disconnect the headset.

With the Base Unit

- 1 Press **DIGITAL SP-PHONE**.
 - The DIGITAL SP-PHONE indicator and the line button light.
- 2 Talk into the **MIC**.
- 3 To hang up, press **DIGITAL SP-PHONE**.

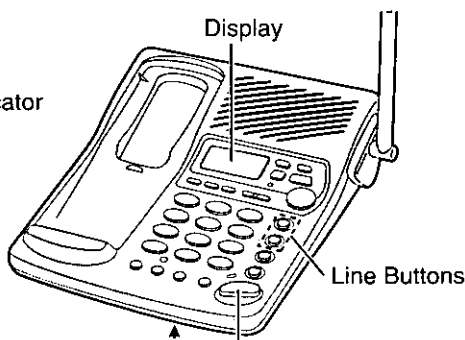

- You may answer a call by pressing the line button instead of **DIGITAL SP-PHONE**.
 - When the ringer volume is set to "OFF", the selected line(s) will not ring (p. 24).
- DIGITAL SP-PHONE** and Indicator

Caller ID Service

This unit is compatible with a Caller ID service offered by your telephone company. If you subscribe to a Caller ID service, the calling party's information will be displayed on the handset and the base unit after the first ring.

The unit can record information of up to 50 different callers for both lines combined, including the time and date received, the number of times called and the called line, in the Caller List. The Caller List information is sorted by the most recent to the oldest call. When the 51st call is received, the first call is deleted.

Using the list, you can automatically call back a caller. You can store the callers' numbers from the Caller List into the directory.

If you subscribe to a Call Waiting Caller ID Feature, when a second call is received while talking, the new caller's name, number and the called line will be displayed on the handset and the base unit (p. 64).

How caller information is displayed when a call is received

The handset and the base unit displays show the caller's name, number and the called line after the first ring.

- After you answer the call, the display will show the length of the call.

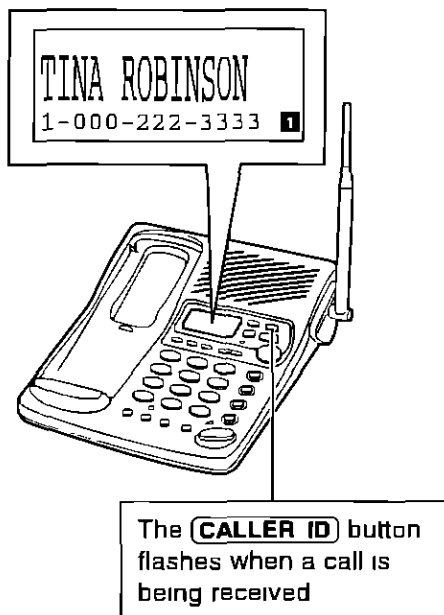
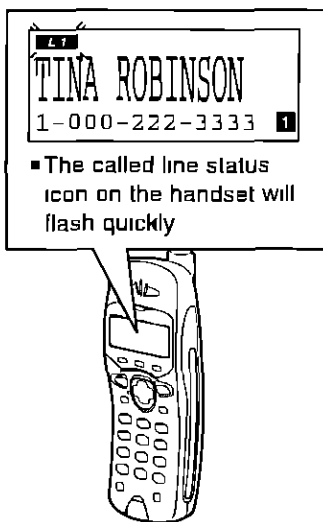

- Caller information cannot be displayed in the following cases
 - If the caller dialed from an area which does not provide a Caller ID service, the display will show "Out of area"
 - If the caller has requested not to display his/her information, the display will show "Private caller"
- If your unit is connected to a PBX which does not support Caller ID services, you cannot access those services
- The name display service may not be available in some areas. For further information, please contact your telephone company

To check the number of new calls

When new calls have been received, the **CALLER ID** button flashes on the base unit

Ex You have received 10 new calls

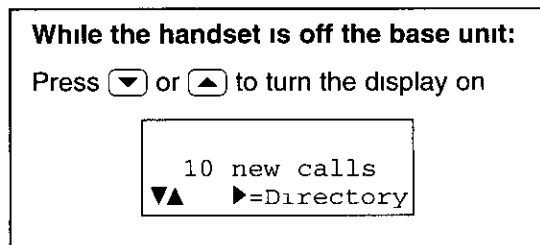
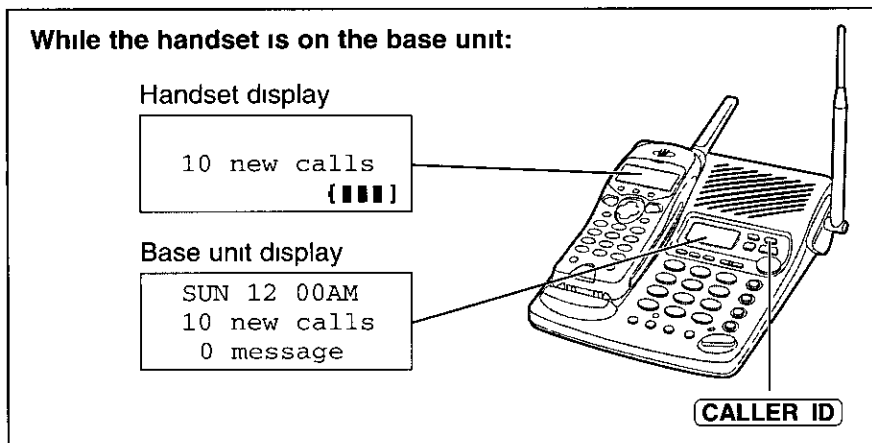



Using the Caller List

Viewing the Caller List

To check who has called, follow the steps below

Make sure the unit is in the standby mode



With the handset



1 Lift the handset off the base unit and press  or  to enter the Caller List

- The display will show, for example, the following

```
2 new calls
▼▲ ▶=Directory
```

- You can go to the directory list by pressing **FWD/EDIT**  (p 53)

2 To search from the most recent call, press 
To search from the oldest call, press 

- To scroll between callers, press  or 

```
JACK SMITH
1-222-333-4444 1
3 10P JUN 10
```

3 To exit the list, press **FUNCTION/EXIT/CH**

- The handset will return to the standby mode

With the base unit

1 Press **CALLER ID** to enter the Caller List

- The display will show, for example, the following

```
2 new calls
<=Old >=New
```

2 To search from the most recent call, press **SKIP/FF**
To search from the oldest call, press **REPEAT/REW**

- To scroll between callers, press **SKIP/FF** or **REPEAT/REW**

```
JACK SMITH
1-222-333-4444 1
3 10P JUN 10
```

3 To exit the list, press **STOP/EXIT**

- The base unit will return to the standby mode

- Once new calls have been checked, "√" will be added
- If "No items stored" is displayed in step 1, the Caller List is empty After 5 seconds, the unit will return to the standby mode
- If more than one call is received from the same caller, the date and time of the most recent call will be recorded If the same caller calls again, the call entry with "√" will be deleted



Display meaning

- √ You have checked this caller information, answered the call or called back the caller
- ×2-×9 The number of times the same caller called (up to 9)
After checking, "×2"- "×9" will be replaced with "√"
- 1, 2** Indication of the called line

Calling Back from the Caller List

With the handset

- 1 Lift the handset off the base unit and press or to enter the Caller List

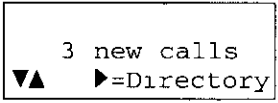

- 2 Press or repeatedly to find the desired caller

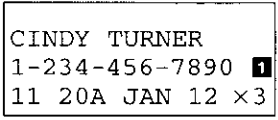

- 3 Press **TALK**
 - The displayed phone number is dialed automatically
 - You can also press a line button instead of **TALK** ,

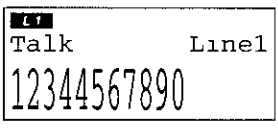

With the base unit

- 1 Press **CALLER ID** to enter the Caller List

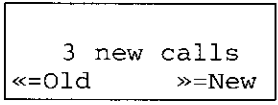

- 2 Press **SKIP/FF** or **REPEAT/REW** repeatedly to find the desired caller

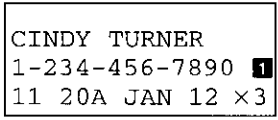

- 3 Press **DIGITAL SP-PHONE**
 - The displayed phone number is dialed automatically
 - You can also press a line button instead of **DIGITAL SP-PHONE**

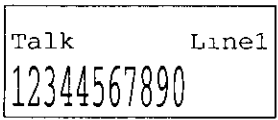

- In some cases, you may have to edit the number before dialing (p 42, 43)
(Ex You may have to delete "1" and the area code)
- If a phone number is not displayed in the caller information, you cannot call back that caller

Cordless Telephone

► Using the Caller List

Editing the Caller's Phone Number

The unit can edit a phone number into one of 4 patterns

Make sure the unit is in the standby mode

With the handset

1 Lift the handset off the base unit and press or to enter the Caller List

2 Press or repeatedly to find the desired caller Press **FWD/EDIT**

3 While the arrow points to "Edit", press **FWD/EDIT** (Yes key)

4 Press **FWD/EDIT** (Edit key) to select a pattern

- Each time you press **FWD/EDIT** , the number is rearranged into one of 4 different patterns

- (a)
- (b) -
- (c) 1 -
- (d) 1 - -

- The order in which patterns (a)–(d) are displayed depends on how the telephone number is displayed in step 2
- You should complete editing a number within 60 seconds

5 After editing the number, you can continue with calling back or storing procedures

To call back, press **TALK** (p 41)

To store the number in the directory, press (Next key) Follow the instructions on the display (p 44)

5 new calls
▼▲ ▶=Directory

FRED PARKER
1-234-321-5555 **1**
11 20A JAN 12 ✓

▶Edit
Save directory
▼▲ ▶=Yes

FRED PARKER
1-234-321-5555 **1**
▼=Next ▶=Edit

(a) FRED PARKER
321-5555 **1**
▼=Next ▶=Edit

(b) FRED PARKER
234-321-5555 **1**
▼=Next ▶=Edit

(c) FRED PARKER
1-321-5555 **1**
▼=Next ▶=Edit

(d) FRED PARKER
1-234-321-5555 **1**
▼=Next ▶=Edit

FRED PARKER
321-5555 **1**
▲=Edit ▶=Save

- The number edited in step 4 will not be maintained in the Caller List



With the base unit

1 Press **CALLER ID** to enter the Caller List

5 new calls
<=Old >=New

2 Press **SKIP/FF** or **REPEAT/REW** repeatedly to find the desired caller

FRED PARKER
1-234-321-5555 1
11 20A JAN 12 ✓

3 Press **GREETING/EDIT** to select a pattern

- Each time you press **GREETING/EDIT**, the number is rearranged into one of 4 different patterns

- (a)
- (b) -
- (c) 1 -
- (d) 1 - -

- The order in which patterns (a)-(d) are displayed depends on how the telephone number is displayed in step 2

(a) FRED PARKER
321-5555 1
11 20A JAN 12 ✓

(b) FRED PARKER
234-321-5555 1
11 20A JAN 12 ✓

(c) FRED PARKER
1-321-5555 1
11 20A JAN 12 ✓

(d) FRED PARKER
1-234-321-5555 1
11 20A JAN 12 ✓

Cordless Telephone

4 After editing the number, you can continue with calling back
To call back, press **DIGITAL SP-PHONE** (p 41)

- The number edited in step 3 will not be maintained in the Caller List



► Using the Caller List

Storing Caller List Information in the Directory

You can store numbers that are in the Caller List in the directory

This feature can operate only with the handset.

Make sure the unit is in the standby mode

1 Lift the handset off the base unit and press  or  to enter the Caller List



10 new calls
▼▲ ▶=Directory

2 Press  or  repeatedly to find the caller you want to store in the directory
Press **FWD/EDIT**  (Yes key)

CINDY TURNER
1-234-456-7890 
11 20A JAN 12 x3

•If the number requires editing, see page 42





▶Edit
Save directory
▼▲ ▶=Yes

3 Press  or  to select "Save directory" Press **FWD/EDIT**  (Yes key)

Edit
▶Save directory
▼▲ ▶=Yes

If there is no name information for the caller, "Enter name" will be displayed

Enter name
r
◀▶ ▼=Next

- If a name is not required, press  (Next key) and **FWD/EDIT**  (Save key)
- If a name is required, enter the name (p 51) When finished, press  (Next key) and **FWD/EDIT**  (Save key)

Enter name
CINDY TURNER
◀▶ ▼=Next

- A beep sounds
- The display will return to step 2 You can continue storing other items
To return to the standby mode, press **FUNCTION/EXIT/CH**

CINDY TURNER
12344567890
▲=Edit ▶=Save

- You can exit the programming mode any time by pressing **FUNCTION/EXIT/CH**
- If the display shows "Directory full" in step 3, the display will return to step 2 Press **FUNCTION/EXIT/CH** to exit the list To erase other stored items from the directory, see page 57
- You cannot store caller information in the directory if a phone number is not displayed
- If the display shows "Save error" or "No link to base Place on cradle and try again" in step 3, the item cannot be stored in the directory Try again from step 1



Erasing Caller List Information

After checking the Caller List, you can erase some or all of the entries
Make sure the unit is in the standby mode.

To erase a specific caller from the Caller List

With the handset

- 1 Lift the handset off the base unit and press or to enter the Caller List

```
10 new calls
▼▲ ▶=Directory
```

- 2 Press or repeatedly to find the caller you want to erase from the Caller List

```
TOM REAGAN
1-888-777-6666 1
12 20A JAN 12 ✓
```

- 3 Press **INTERCOM/HOLD/CLEAR**

```
Clear
```

- A beep sounds and the information is erased
- To erase other items, repeat from step 2
- To return to the standby mode, press **FUNCTION/EXIT/CH**

With the base unit

- 1 Press **CALLER ID** to enter the Caller List

```
10 new calls
<<=Old >>=New
```

- 2 Press **SKIP/FF** or **REPEAT/REW** repeatedly to find the caller you want to erase from the Caller List

```
TOM REAGAN
1-888-777-6666 1
12 20A JAN 12 ✓
```

- 3 Press **ERASE/CLEAR**

```
Clear
```

- A beep sounds and the information is erased
- To erase other items, repeat from step 2
- To return to the standby mode, press **STOP/EXIT**

Cordless Telephone

► Using the Caller List

To erase all entries in the Caller List

Before erasing all entries, make sure that "0 new call" is displayed



With the handset

- 1 Lift the handset off the base unit and press  or  to enter the Caller List

```
0 new call
▼▲ ▶=Directory
```

- 2 Press **INTERCOM/HOLD/CLEAR**

```
▶Exit
All clear
▼▲ ▶=Yes
```

- 3 Press  or  to select "All clear"

```
Exit
▶All clear
▼▲ ▶=Yes
```

- 4 Press **FWD/EDIT**  (Yes key) or **INTERCOM/HOLD/CLEAR**

```
All clear
```

- A beep sounds and all entries are erased
- The handset will return to the standby mode

With the base unit

- 1 Press **CALLER ID** to enter the Caller List

```
0 new call
<<=Old >>=New
```

- 2 Press **ERASE/CLEAR**

```
Press ERASE for
all clear
```

- 3 Press **ERASE/CLEAR** again

```
All clear
```

- A beep sounds and all entries are erased
- The base unit will return to the standby mode

One-Touch Dialer



A phone number stored in the **DIRECT** button can be dialed with a one-touch operation

Storing a Phone Number in the DIRECT Button

Make sure the unit is in the standby mode

1 Press **FUNCTION/EXIT/CH**

2 Press **▼** or **▲** repeatedly until the arrow points to "Program"

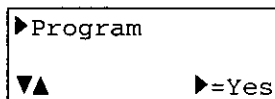

3 Press **FWD/EDIT** **▶** (Yes key)

4 While the arrow points to "Save DIRECT#", press **FWD/EDIT** **▶** (Yes key)

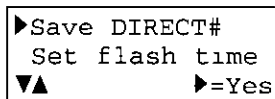

5 Enter a phone number, up to 48 digits

- Each time you press **INTERCOM/HOLD/CLEAR**, the digit to the left of the cursor is erased. To erase all of the digits, press and hold **INTERCOM/HOLD/CLEAR**
- The last 32 digits number you entered will be displayed. To confirm the remaining number, press **BACK** **◀** or **FWD/EDIT** **▶**

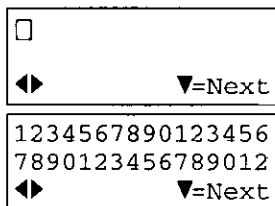

1234567890123456
7890123456789012
◀ =Next

6 Press **▼** (Next key)

- If you want to edit the entered number, press **▲** (Edit key) and return to step 5

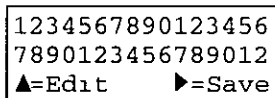

1234567890123456
7890123456789012
▲ =Edit ▶ =Save

7 Press **FWD/EDIT** **▶** (Save key)

- A beep sounds
- To return to the standby mode, press **FUNCTION/EXIT/CH**

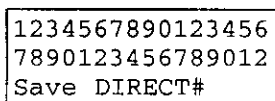

1234567890123456
7890123456789012
Save DIRECT#

- You can exit the programming mode any time by pressing **FUNCTION/EXIT/CH**
- If a pause is required for dialing, **REDIAL/PAUSE** can be stored in a phone number counting as one digit (p. 64) in step 5

► One-Touch Dialer

Dialing the Stored Number in the DIRECT Button

- 1 Press **DIRECT**
 - The stored number is dialed automatically
 - After a few seconds, the display will show the length of the call and the battery strength

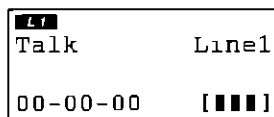
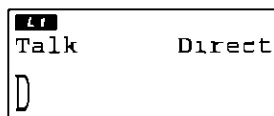

- 2 To hang up, press **TALK** or place the handset on the base unit

- You can also dial the stored number in the **DIRECT** button by pressing **TALK** or a line button and then **DIRECT**

Using the Directory



You can store up to 50 names and phone numbers in the directory. All directory items are sorted by the first word in alphabetical order. Using the directory, you can make a call by selecting a name on the handset or base unit display.

Storing Names and Numbers in the Directory

Make sure the unit is in the standby mode.

Cordless Telephone

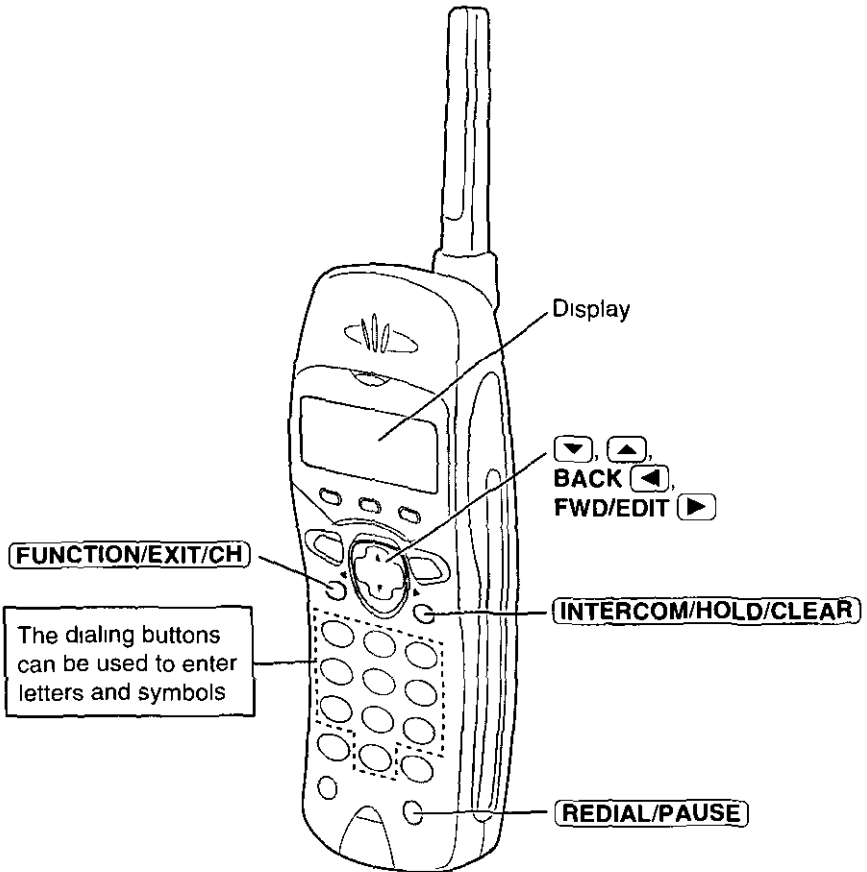

- While storing or finding items in the directory, "📖" will be shown on the display

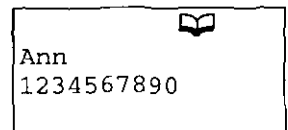

(continued ▶)

► Using the Directory

1 Press **FUNCTION/EXIT/CH**

```
► Save directory
Ringer volume
▼▲                               ►=Yes
```

2 While the arrow points to "Save directory", press **FWD/EDIT** (►) (Yes key)

```
Directory=
20 items
```

- The display shows the number of stored items in the directory

3 Enter a name, up to 15 characters, with the dialing buttons, **BACK** (◀) or **FWD/EDIT** (►)

```
Enter name
□
◀▶                               ▼=Next
```

- See the steps for entering names and symbols (p 51)
- If a name is not required, press (▼) (Next key) and go to step 5

```
Enter name
Tom Jones
◀▶                               ▼=Next
```

4 Press (▼) (Next key)

```
Enter phone no
```

5 Enter a phone number, up to 22 digits

- Each time you press **INTERCOM/HOLD/CLEAR**, a character is erased from the right. To erase all of the digits, press and hold **INTERCOM/HOLD/CLEAR**

```
0987654321□
◀▶                               ▼=Next
```

6 Press (▼) (Next key)

```
Tom Jones
0987654321
▲=Edit                               ►=Save
```

7 Press **FWD/EDIT** (►) (Save key)

- A beep sounds
- To continue storing other items, repeat from step 2
- To return to the standby mode, press **FUNCTION/EXIT/CH**

- If a pause is required for dialing, **REDIAL/PAUSE** can be stored in a phone number counting as one digit (p 64) in step 5
- You can exit the programming mode any time by pressing **FUNCTION/EXIT/CH**
- If the display shows "Directory full" in step 2, the display will return to step 1. Press **FUNCTION/EXIT/CH** to exit the list. To erase other stored items from the directory, see page 57
- If the display shows "Save error" in step 7, the item cannot be stored in the directory. Try again from step 1



Steps for Entering Names and Symbols

The handset dialing buttons (0 to 9), **BACK** ◀ and **FWD/EDIT** ▶ can be used to enter letters and symbols

Each button selects a character as shown below

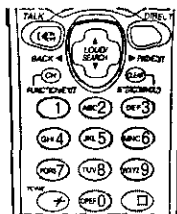

Keys	Number of times key is pressed										
	1	2	3	4	5	6	7	8	9	10	11
①	#	&	'	()	*	,	-		/	1	
②	A	B	C	a	b	c	2				
③	D	E	F	d	e	f	3				
④	G	H	I	g	h	i	4				
⑤	J	K	L	j	k	l	5				
⑥	M	N	O	m	n	o	6				
⑦	P	Q	R	S	p	q	r	s	7		
⑧	T	U	V	t	u	v	8				
⑨	W	X	Y	Z	w	x	y	z	9		
⑩	0	Blank									
BACK ◀	To move the cursor to the left										
FWD/EDIT ▶	To move the cursor to the right										

- To enter another character using the same dialing button, press **FWD/EDIT** ▶ to move the cursor to the next space







If you make a mistake while entering a name

Use **BACK** ◀ or **FWD/EDIT** ▶ to move the cursor to the incorrect character, press **INTERCOM/HOLD/CLEAR** to delete and enter the correct character. Each time you press **INTERCOM/HOLD/CLEAR**, a character is erased from the right.

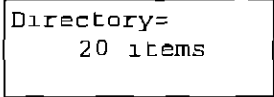
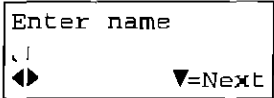
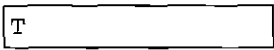
To erase all characters, press and hold **INTERCOM/HOLD/CLEAR**

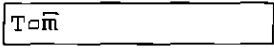
► Using the Directory

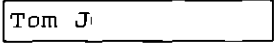
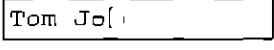
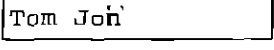
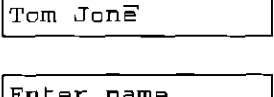
For example, to enter "Tom Jones":

- 1 Press **FUNCTION/EXIT/CH**
- 2 While the arrow points to "Save directory", press **FWD/EDIT** (▶) (Yes key)

- 3 Press **B**

- 4 Press **6** six times, then press **FWD/EDIT** (▶) to move the cursor to the right

- 5 Press **6** four times

- 6 Press **FWD/EDIT** (▶) twice to enter a blank

- 7 Press **5**

- 8 Press **6** six times, then press **FWD/EDIT** (▶) to move the cursor to the right

- 9 Press **6** five times

- 10 Press **3** five times

- 11 Press **7** eight times

- 12 When finished, press **▼** (Next key)
• Follow steps 5 to 7 on page 50 to complete the operation

• While entering names, the cursor will flash on the display



Finding Items in the Directory

With the handset

Make sure the unit is in the standby mode.

- 1 Press **BACK** (◀) or **FWD/EDIT** (▶) to enter the directory list

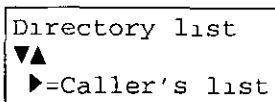

- 2 Press (▼) or (▲)
•The first item is displayed

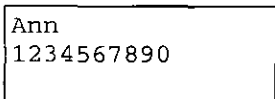

- 3 Press (▼) or (▲) repeatedly until the desired item is displayed
•All directory items are stored in the order shown on the right

To search for a name by the initial

- ① Press the dialing button for the first letter of the desired name until any name with the same initial is displayed (see the Index table on page 55)

Ex To find "Frank", press (3) repeatedly until the first item under "F" is displayed

- ② Press (▼) until the name is displayed

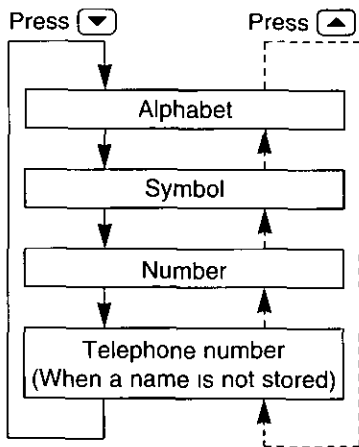
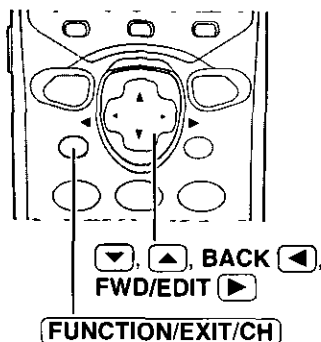

- You can exit the directory list any time by pressing **FUNCTION/EXIT/CH**
- If "No items stored" is displayed in step 2, the directory is empty To return to the standby mode, press **FUNCTION/EXIT/CH**
- In step 1, you can go to the Caller List by pressing **FWD/EDIT** (▶) (p. 40)

► Using the Directory

With the base unit

Make sure the unit is in the standby mode

- 1 Press **DIRECTORY** to enter the directory list

- The first item is displayed

Ann
1234567890

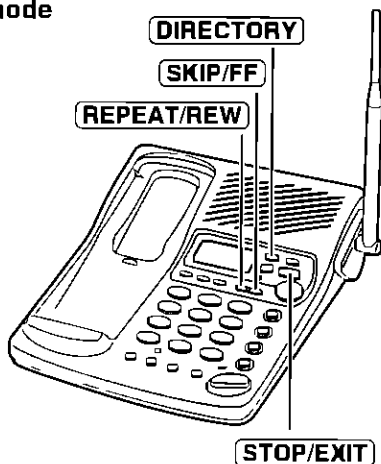

- 2 Press **SKIP/FF** or **REPEAT/REW** repeatedly until the desired item is displayed

- All directory items are stored in the order shown on the right

To search for a name by the initial

- ① Press the dialing button for the first letter of the desired name until any name with the same initial is displayed (see the Index table on page 55)

Ex To find "Frank", press **3** repeatedly until the first item under "F" is displayed

- ② Press **SKIP/FF** until the name is displayed

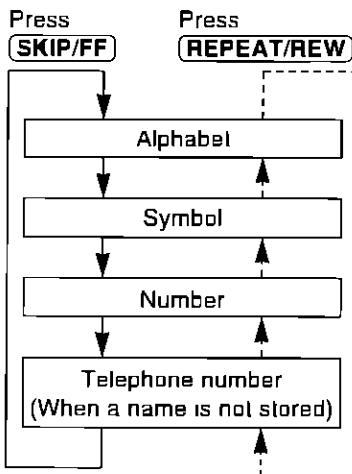

- You can exit the directory list any time by pressing **STOP/EXIT**
- If "No items stored" is displayed in step 2, the directory is empty To return to the standby mode, press **STOP/EXIT**



Index table

Keys	Index	Keys	Index
①	Other symbols, 1	⑥	M, N, O, 6
②	A, B, C, 2	⑦	P, Q, R, S, 7
③	D, E, F, 3	⑧	T, U, V, 8
④	G, H, I, 4	⑨	W, X, Y, Z, 9
⑤	J, K, L, 5	⑩	0

Dialing from the Directory

With the handset

- 1 Press **BACK** (◀) or **FWD/EDIT** (▶) to enter the directory list.
- 2 Press (▼) or (▲).
 - The first item is displayed.
- 3 Press (▼) or (▲) repeatedly to find the directory item that you want to dial (p. 53).

```

Frank
4567890
  
```

- 4 Press **TALK**.
 - The number is dialed automatically.
 - You can also press a line button instead of **TALK**.

```

[5] Talk Line1
4567890
  
```

- 5 To hang up, press **TALK** or place the handset on the base unit.

- You can exit the directory list any time by pressing **FUNCTION/EXIT/CH**.

With the base unit

- 1 Press **DIRECTORY** to enter the directory list.
 - The first item is displayed.
- 2 Press **SKIP/FF** or **REPEAT/REW** repeatedly to find the directory item that you want to dial (p. 54).

```

Frank
4567890
  
```

- 3 Press **DIGITAL SP-PHONE**.
 - The number is dialed automatically.
 - You can also press a line button instead of **DIGITAL SP-PHONE**.

```

Talk Line1
4567890
  
```

- 4 To hang up, press **DIGITAL SP-PHONE**.

- You can exit the directory list any time by pressing **STOP/EXIT**.

► Using the Directory

Editing an Item in the Directory

This feature can operate only with the handset
Make sure the unit is in the standby mode

1 Press **BACK** (◀) or **FWD/EDIT** (▶) to enter the directory list

2 Press (▼) or (▲)
▪ The first item is displayed

3 Press (▼) or (▲) repeatedly to find the directory item you want to change (p 53)
Press **FWD/EDIT** (▶)

```
Jane
1234567
```

```
Enter name
Jane
◀          ▼=Next
```

4 Edit the name using the dialing buttons, **BACK** (◀) or **FWD/EDIT** (▶) (p 51), up to 15 characters

```
Enter name
Jane Walker
◀          ▼=Next
```

5 Press (▼) (Next key)
▪ If you do not need to change the number, press (▼) (Next key) twice and go to step 8

```
1234567
◀          ▼=Next
```

6 Add a number to the current number
▪ Each time you press **INTERCOM/HOLD/CLEAR**, a character is erased from the right. To erase all of the digits, press and hold **INTERCOM/HOLD/CLEAR**

```
0981234567
◀          ▼=Next
```

7 Press (▼) (Next key)

```
Jane Walker
0981234567
▲=Edit    ▶=Save
```

8 When finished, press **FWD/EDIT** (▶) (Save key)
▪ To continue editing other items, repeat steps 3 through 8
▪ To return to the standby mode, press **FUNCTION/EXIT/CH**

```
Jane Walker
0981234567
```

▪ You can exit the directory list any time by pressing **FUNCTION/EXIT/CH**

Erasing an Item from the Directory

Make sure the unit is in the standby mode

With the handset

1 Press **BACK** (◀) or **FWD/EDIT** (▶) to enter the directory list

2 Press (▼) or (▲)
•The first item is displayed

3 Press (▼) or (▲) repeatedly to find the directory item you want to erase (p 53)

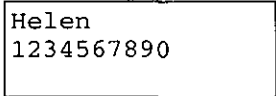

```
Helen
1234567890
```

4 Press **INTERCOM/HOLD/CLEAR**

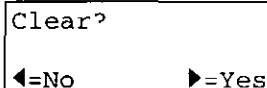

```
Clear?
◀=No      ▶=Yes
```

5 Press **FWD/EDIT** (▶) (Yes key) or **INTERCOM/HOLD/CLEAR**



```
Clear
```

- The display will show the next item
- To return to the standby mode, press **FUNCTION/EXIT/CH**

- You can exit the directory list any time by pressing **FUNCTION/EXIT/CH**

With the base unit

1 Press **DIRECTORY** to enter the directory list

- The first item is displayed

2 Press **SKIP/FF** or **REPEAT/REW** repeatedly to find the directory item you want to erase (p 54)

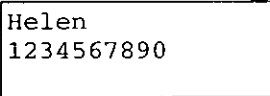

```
Helen
1234567890
```

3 Press **ERASE/CLEAR**

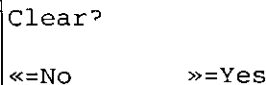

```
Clear?
◀=No      >>=Yes
```

4 Press **SKIP/FF** (Yes key) or **ERASE/CLEAR**



```
Clear
```

- The display will show the next item
- To return to the standby mode, press **STOP/EXIT**

- You can exit the directory list any time by pressing **STOP/EXIT**

Using the Other Line During a Conversation

While Someone Else is Using a Line (Simultaneous Base/Handset Calling)

The handset and base unit can be used at the same time on separate telephone lines

To make a call with the handset

1 EX: If the base unit is using LINE 1

Press the other line button (LINE 2) on the handset

- The LINE 2 status icon is displayed

2 Dial a phone number

3 To hang up, press **TALK** or place the handset on the base unit

To make a call with the base unit

1 EX: If the handset is using LINE 1

Press the other line button (LINE 2) on the base unit

- The DIGITAL SP-PHONE indicator and the LINE 2 button light

2 Dial a phone number

3 To hang up, press **DIGITAL SP-PHONE**

To answer a call with the handset

1 EX: If the base unit is using LINE 1

Press the other line button (LINE 2) on the handset

2 To hang up, press **TALK** or place the handset on the base unit

To answer a call with the base unit

1 EX: If the handset is using LINE 1

Press the other line button (LINE 2) on the base unit

2 To hang up, press **DIGITAL SP-PHONE**

- If another phone is connected on either line, you can also use it while the handset or base unit is using the other line

While You are Using a Line

During a conversation, if **two tones** sound and the other line status icon on the handset display and the other line button on the base unit flash quickly, an incoming call is being received on that line. You can answer the second call while holding the first call. You can also make a call without terminating the first call. If you subscribe to a Caller ID service, the second caller's information will be displayed when a call is being received on the other line (p. 38).

You may delete the **two tones** (incoming call tone) by programming. See page 67.

With the handset

- 1 **EX: If you are using LINE 1**
Press **INTERCOM/HOLD/CLEAR** to put the first call (LINE 1) on hold.
 - The LINE 1 status icon flashes.
- 2 Press the other line button (LINE 2) to make or answer a second call.
 - The LINE 2 status icon is displayed.
- 3 To return to the first call (LINE 1), press the line button for the first call (LINE 1).
 - The second call is terminated.

With the base unit

- 1 **EX: If you are using LINE 1**
Press **LOCATOR/INTERCOM/HOLD** to put the first call (LINE 1) on hold.
 - The LINE 1 button flashes.
- 2 Press the other line button (LINE 2) to make or answer a second call.
 - The LINE 2 button lights.
- 3 To return to the first call (LINE 1), press the line button for the first call (LINE 1).
 - The second call is terminated.

- To hold the second call in step 3, press **INTERCOM/HOLD/CLEAR** or **LOCATOR/INTERCOM/HOLD** before pressing the line button for the first call.

Conference Call

While having a conversation on one line, you can make or answer a second call on the other line and then combine the calls to make a conference call

With the handset

1 EX. If you are using LINE 1

Press

INTERCOM/HOLD/CLEAR to put the first call (LINE 1) on hold

- The LINE 1 status icon flashes

2 Press the other line button (LINE 2) to make or answer a second call

- The LINE 2 status icon is displayed

3 When the second call is connected, press **CONF** to make a conference call

- Both line status icons are displayed

With the base unit

1 EX: If you are using LINE 1

Press

LOCATOR/INTERCOM/HOLD to put the first call (LINE 1) on hold

- The LINE 1 button flashes

2 Press the other line button (LINE 2) to make or answer a second call

- The LINE 2 button lights

3 When the second call is connected, press **RINGER/CONF** to make a conference call

- Both line buttons light

During a conference call using the handset.

- To hang up both lines, press **TALK**
- To hang up only one line, press the line button for the party with which you want to continue talking
- To put both lines on hold, press **INTERCOM/HOLD/CLEAR**
To talk with only one caller, press the corresponding line button
To resume both lines, press **CONF**

During a conference call using the base unit

- To hang up both lines, press **DIGITAL SP-PHONE**
- To hang up only one line, press the line button for the party with which you want to continue talking
- To put both lines on hold, press **LOCATOR/INTERCOM/HOLD**
To talk with only one caller, press the corresponding line button
To resume both lines, press **RINGER/CONF**

Intercom



A 2-way intercom is possible between the handset and the base unit

Paging the base unit from the handset

- 1 Handset**
Press **INTERCOM/HOLD/CLEAR**
Talk to the paged party after the beeps
 - "Intercom" is displayed
- 2 Base unit**
When the other party's voice is heard, answer using the **MIC**
- 3 Handset**
To end the intercom, press **INTERCOM/HOLD/CLEAR**

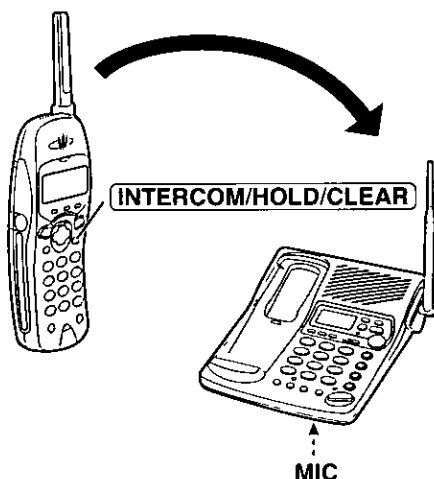

Paging the handset from the base unit (Handset locator)

Using this feature, you can locate a misplaced handset

- 1 Base unit**
Press **LOCATOR/INTERCOM/HOLD**
 - "Paging" is displayed on the base unit
 - The handset beeps for 1 minute and displays "Paging Press INTERCOM"
 - To stop paging, press **LOCATOR/INTERCOM/HOLD** again
- 2 Handset**
Press **INTERCOM/HOLD/CLEAR** to answer
 - "Intercom" is displayed
- 3 Base unit**
Talk into the **MIC**
- 4 Handset**
To end the intercom, press **INTERCOM/HOLD/CLEAR**

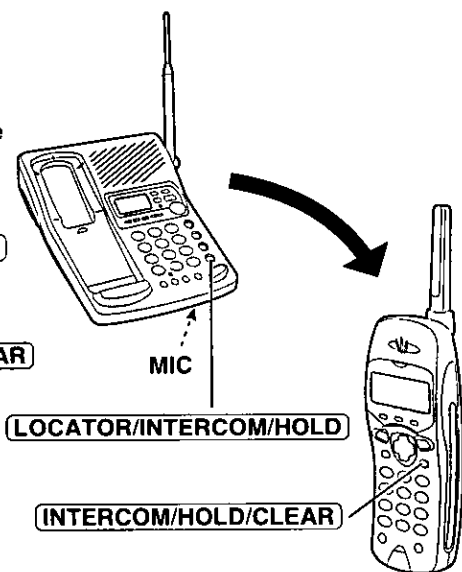

► Intercom

During an intercom call-

- Intercom calls can only be ended with the handset
- If the handset user has difficulty hearing the base unit user, decrease the base unit speaker volume by pressing **VOLUME** (▼)
- If an incoming call is received, the intercom call stops and the unit starts to ring. To answer, press **(TALK)**, **(DIGITAL SP-PHONE)** or the relevant line button

Transferring a Call Using the Intercom

The intercom can be used during a call. This feature enables you to transfer a call between the handset and the base unit.

From the handset to the base unit

- 1 Handset**
During a call, press **(INTERCOM/HOLD/CLEAR)**
 - The call is put on hold and "Hold" is displayed
- 2 Handset**
During a call, press **(INTERCOM/HOLD/CLEAR)** again. Talk to the paged party after the beeps.
 - "Intercom hold" is displayed
 - If the base unit user does not answer, press the line button whose status icon is flashing
- 3 Base unit**
When the paging party's voice is heard, answer using the **MIC**
- 4 Base unit**
To answer the call, press the line button which is flashing
 - The transfer is complete

From the base unit to the handset

- 1 Base unit**
During a call, press **(LOCATOR/INTERCOM/HOLD)**
 - The call is put on hold
- 2 Base unit**
During a call, press **(LOCATOR/INTERCOM/HOLD)** again.
 - "Paging Press INTERCOM" is displayed on the handset
 - If the handset user does not answer, press the line button which is flashing
- 3 Handset**
Press **(INTERCOM/HOLD/CLEAR)** to answer the page.
 - "Intercom hold" is displayed
- 4 Handset**
To answer the call, press the line button whose status icon is flashing
 - The transfer is complete

Special Features

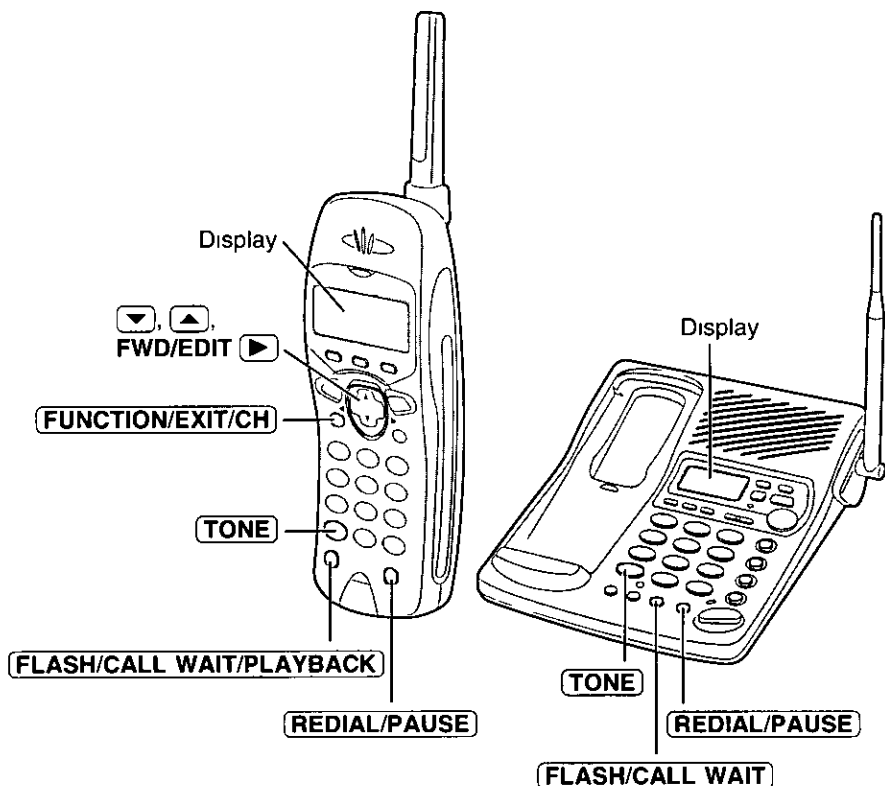

Cordless Telephone

Automatic Security Code Setting

Each time you place the handset on the base unit, the unit automatically selects one of more than a million security codes. These codes help prevent the unauthorized use of your telephone line by another cordless telephone user.

Temporary Tone Dialing (For Rotary or Pulse Service Users)

Press **TONE** before entering access numbers which require tone dialing.

- The dialing mode changes to tone. You can enter numbers to access an answering service, electronic banking service, etc. When you hang up, the mode will return to pulse.
- Access numbers entered after pressing **TONE** will not be included when redialing.

► Special Features

How to Use the PAUSE Button (For Analog PBX Line/Long Distance Service Users)

We recommend you press **(REDIAL/PAUSE)** if a pause is required for dialing with a PBX or to access a long distance service

Ex Line access number **(9)** (PBX)

(9) → **(REDIAL/PAUSE)** → Phone number

- Pressing **(REDIAL/PAUSE)** once creates a 3.5 second pause. This prevents misdialing when you redial or dial a stored number.
- Pressing **(REDIAL/PAUSE)** more than once increases the length of the pause between numbers.

For Call Waiting Service Users

Press **(FLASH/CALL WAIT/PLAYBACK)** or **(FLASH/CALL WAIT)** if you hear a call-waiting tone while talking.

- The first call is put on hold and you can answer the second call.
- To return to the first caller, press **(FLASH/CALL WAIT/PLAYBACK)** or **(FLASH/CALL WAIT)** again.
- The call waiting service cannot be used when
 - you are having a conference call (p. 60), or
 - the answering system is recording someone's message.
- If this function does not operate properly, consult your telephone company for details.

Call Waiting Caller ID Feature

Call Waiting Caller ID Feature allows your unit to display the second caller's information. After you hear a call-waiting tone while talking, the unit will display the caller's name with the phone number and "--- Waiting ----"

NANCY BROWN
1-000-222-3333 [1]
--- Waiting ----

- The called line status icon is displayed on the handset.
- Please contact your telephone company for details and availability in your area.



FLASH Button

Pressing **FLASH/CALL WAIT/PLAYBACK** or **FLASH/CALL WAIT** allows you to use special features of your host PBX such as transferring an extension call or accessing special telephone services (optional) such as call waiting

Selecting the flash time

The flash time depends on your telephone exchange or host PBX. You can select the following flash times "700, 600, 400, 300, 250, 110, 100 or 90 ms (milliseconds)". Your phone comes from the factory set to "700 ms"

Make sure the unit is in the standby mode.

1 Press **FUNCTION/EXIT/CH**

2 Press or repeatedly until the arrow points to "Program"

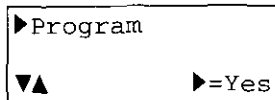

3 Press **FWD/EDIT** (Yes key)

4 Press or repeatedly until the arrow points to "Set flash time"

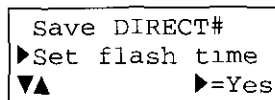

5 Press **FWD/EDIT** (Yes key)

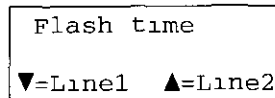

6 Press (Line1) or (Line2) to select the desired line

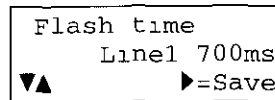

7 Press or repeatedly until the desired time is displayed

8 Press **FWD/EDIT** (Save key)

- A beep sounds
- To program the other line, start again from step 4
- To return to the standby mode, press **FUNCTION/EXIT/CH**

- You can exit the programming mode any time by pressing **FUNCTION/EXIT/CH**
- If you are connected via a PBX, a longer flash time may be necessary to use PBX functions (transferring a call etc). Consult your PBX supplier for the correct setting

Cordless Telephone



► Special Features

Line Selection

The unit will automatically select a free line which is not being used by a parallel connected telephone when you make a call. The unit will select the called line when you answer a call. To change the line selection, program as follows

Make sure the unit is in the standby mode

1 Press **FUNCTION/EXIT/CH**

2 Press  or  repeatedly until the arrow points to "Program"

```
►Program
▼▲                               ►=Yes
```

3 Press **FWD/EDIT**  (Yes key)

4 Press  or  repeatedly until the arrow points to "Line selection"

```
►Line selection
  Incoming call
▼▲                               ►=Yes
```

5 Press **FWD/EDIT**  (Yes key)

•The current selection is displayed

Line1 LINE 1 will be selected

Line2 LINE 2 will be selected

Auto A free line will be selected (LINE 1 has priority) when making a call. The called line is automatically selected when answering a call (factory preset)

```
Line selection
  Auto
▼▲                               ►=Save
```

6 Press  or  repeatedly until the desired line selection is displayed

```
Line selection
  Line2
▼▲                               ►=Save
```

7 Press **FWD/EDIT**  (Save key)

•A beep sounds

•To return to the standby mode, press

FUNCTION/EXIT/CH

```
Line selection
  Line2
```

•You can exit the programming mode any time by pressing **FUNCTION/EXIT/CH**

•Any line can be selected manually, regardless of the mode selected in step 6, by pressing the line button

Incoming Call Tone

While one line is being used, you can be informed if another call arrives on the other line by two tones. This incoming call tone can be set/deleted by programming. Your phone comes from the factory set to "2".
Make sure the unit is in the standby mode.

1 Press **FUNCTION/EXIT/CH**

2 Press **▼** or **▲** repeatedly until the arrow points to "Program"



3 Press **FWD/EDIT** **▶** (Yes key)

4 Press **▼** or **▲** repeatedly until the arrow points to "Incoming call "

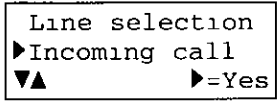

5 Press **FWD/EDIT** **▶** (Yes key)

- The current setting is displayed
- On** The incoming call tone will be heard for as long as the other line rings
- 2** The incoming call tone will only be heard 2 times (factory preset)
- Off** The incoming call tone will not be heard

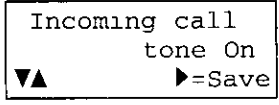

6 Press **▼** or **▲** repeatedly until the desired setting is displayed

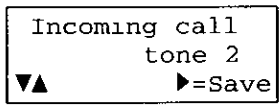

7 Press **FWD/EDIT** **▶** (Save key)

- A beep sounds
- To return to the standby mode, press **FUNCTION/EXIT/CH**

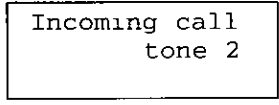

•You can exit the programming mode any time by pressing **FUNCTION/EXIT/CH**

Automatic Answering Operation

When the unit answers a call, a greeting message is played and the caller's message is recorded. While recording, "- Answering -" will flash.

- The total recording time (including greeting message) is **about 15 minutes**. If messages are recorded in noisy rooms, the time may be shortened by up to 3 minutes.
- A maximum of 64 messages (including greeting message) can be recorded.

Setting the Unit to Answer Calls

1 a) To turn on the answering system **on both lines**, press **LINE SELECT** repeatedly until "**L1 L2**" is displayed.

b) To turn on the answering system **on either line**, press **LINE SELECT** repeatedly until "**L1**" or "**L2**" is displayed.

2 Press **ANSWER ON** to turn on the answering system.

- The ANSWER ON indicator lights.
- "Answer set" and the selected line(s) will be announced.

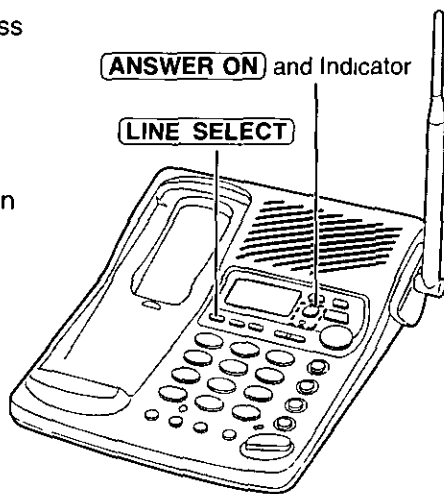

- If another button is pressed between steps 1 and 2, the selected line(s) may not be turned on.
- The unit will announce the remaining recording time if it is less than 5 minutes.
- If you hear "Memory full", "Message full" is displayed on the base unit and the ANSWER ON indicator flashes rapidly, erase some, or all, of the messages (p 73).
- You can also turn on the answering system remotely using any other phone (p 80).

To turn off the answering system

Press **ANSWER ON**

- The ANSWER ON indicator light goes out and "Answer off" is heard
- To turn off the answering system on either line when both lines are turned on, press **LINE SELECT** repeatedly until the line which you want to leave on is displayed, and press **ANSWER ON**

Monitoring incoming calls

While a call is being recorded, you can monitor it through the speaker. To answer the call with the speakerphone, press the line button which is flashing on the base unit. For the handset, press the line button whose status icon is displayed. The unit stops recording.

Listening to Messages

You can see the total number of recorded messages on the base unit display. If the ANSWER ON indicator flashes, new messages have been recorded.

Listening to only new messages

Press **NEW MESSAGE** briefly.

- The unit announces the number of new messages on the line(s) for which the answering system is on and plays them back.
- To listen to new messages on either or both line(s), press **LINE SELECT** repeatedly to select the desired line(s), then press **NEW MESSAGE** briefly.

Listening to all recorded messages

Press and hold **NEW MESSAGE** until playback starts.

- The unit announces the number of all recorded messages on the line(s) for which the answering system is on and plays them back.
- To listen to all recorded messages on either or both line(s), press **LINE SELECT** repeatedly to select the desired line(s), then press and hold **NEW MESSAGE** until playback starts.

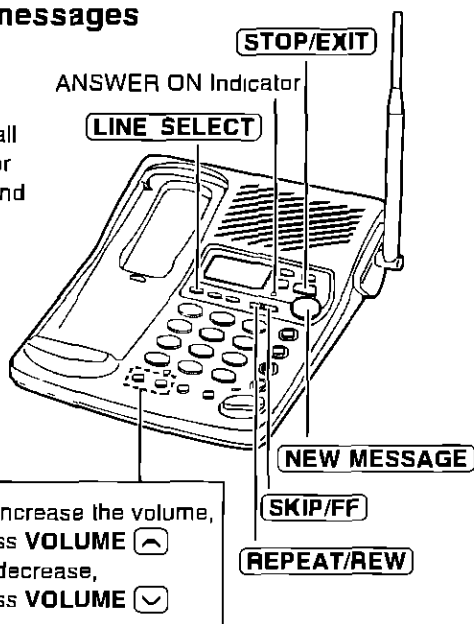

- During playback, the display shows which message is being played (Ex: While the first message is being played back, "Message 1" is displayed).
- At the end of the last message, "End of final message" is heard. The unit will announce the remaining recording time if it is less than 5 minutes.

When the answering system for both lines is turned on

- The messages are played back from the oldest on both lines.
- The corresponding line icon will flash when a message on that line is being played.



During playback

To repeat/
rewind
message

To repeat from the beginning of the message

Press **(REPEAT/REW)** briefly

- If you press within 5 seconds of playback, the previous message will be played

To rewind part of the message

Press and hold **(REPEAT/REW)** until you reach the desired place

- At the beginning of the message, 3 beeps will sound

To skip/cue
message

To skip to the next message

Press **(SKIP/FF)** briefly

To cue to part of the message

Press and hold **(SKIP/FF)** until you reach the desired place

- The message will be heard at twice the normal speed
- At the end of the message, 3 beeps will sound

To stop
operation

Press **(STOP/EXIT)**

- To resume playback, press **(NEW MESSAGE)**

- If you do not press any button for 60 seconds or if you press **(STOP/EXIT)** again, the unit will return to the standby mode

For Caller ID service users (p 38)

- During playback, the base unit display will show the name and/or number of the caller whose message is being played

To call back the displayed number

During playback, lift the handset and press **(TALK)** within 10 seconds, or press **(DIGITAL SP-PHONE)**

—The unit stops playback and automatically dials the displayed phone number

- After listening to new incoming messages, “✓” will be added to the call entries in the Caller ID Caller List (p 41)

► Listening to Messages

From the Handset

If someone else is in the room and you want to listen to the recorded messages privately, you can use the handset

1 Handset
Press **FLASH/CALL WAIT/PLAYBACK**

- The number of new messages on the line(s) for which the answering system is on is heard on the handset

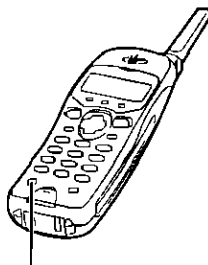

2 Base unit
To listen to new messages, press **NEW MESSAGE** briefly
To listen to all messages, press and hold **NEW MESSAGE** until playback starts

- The messages will be heard on the handset
- **REPEAT/REW**, **SKIP/FF** and **STOP/EXIT** can also be used during playback (p 71)

FLASH/CALL WAIT/PLAYBACK



3 When finished, press **FLASH/CALL WAIT/PLAYBACK** or place the handset on the base unit



- You can also listen to messages without using the base unit See page 81

Erasing Messages

The unit will announce the remaining recording time after playback, if it is less than 5 minutes. New messages cannot be recorded when

—“Memory full” is heard

—“Message full” is displayed on the base unit

—the ANSWER ON indicator flashes rapidly

Erase some, or all, of the messages. We recommend you erase unnecessary messages after each playback.

Erasing a specific message

Press **ERASE/CLEAR** while the message you want to erase is being played.

- The unit erases the message
- A short beep will sound and the unit will continue to play the next message

Erasing all messages

All recorded messages, except the greeting message(s), can be erased at one time.

- 1 a) To erase all messages **on both lines**, press **LINE SELECT** repeatedly until “**L1 L2**” is displayed.
b) To erase all messages **on either line**, press **LINE SELECT** repeatedly until “**L1**” or “**L2**” is displayed.

- 2 Press **ERASE/CLEAR**
 - “Press ERASE again to erase all messages” is heard

- 3 Within 5 seconds, press **ERASE/CLEAR** again
 - A beep sounds, and the selected line and “No messages” are heard
 - The base unit display shows “0 message”

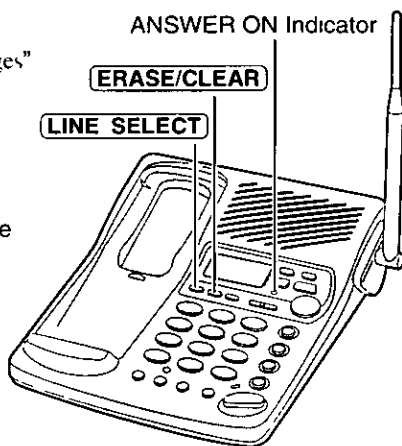

- The information in the Caller List will not be erased. To erase Caller List information, see page 45

Remote Operation from a Touch Tone Phone

You can operate the answering system from any touch tone phone

A synthesized voice menu will guide you on how to operate the unit (p 76)

- To skip the voice menu and operate the unit directly, see page 78

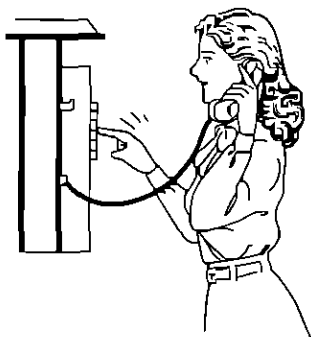

Summary of remote operation

Call your unit from a touch tone phone

Enter your remote code (p 75) during or after the greeting message

- The unit announces the line(s) for which the answering system is on and the number of new messages on the line(s)

After 3 seconds, the voice menu will start. Follow the voice menu (p 76)

- You can only use the line(s) for which the answering system is already on

Enter the direct remote operation (p 78)

- You can control the unit by direct commands (p 79, 80)
- The direct remote operation is available even when the voice menu has started
- You can also choose the line(s) that you want to operate (p 78)

To end remote operation, hang up

- The messages are saved

- The unit will announce the remaining recording time after playback, if it is less than 5 minutes



Setting the Remote Code

The remote code prevents unauthorized people from accessing your unit and listening to your messages. Choose any **2-digit number (00–99)**. The factory preset remote code is “11”. If you do not program your own remote code, you can use “11”.

Make sure the unit is in the standby mode.

- 1 Press **FUNCTION/EXIT/CH**.
- 2 Press **▼** or **▲** repeatedly until the arrow points to “Program”.
- 3 Press **FWD/EDIT** **▶** (Yes key).
- 4 Press **▼** or **▲** repeatedly until the arrow points to “TAD program”.
- 5 Press **FWD/EDIT** **▶** (Yes key).
 - The base unit display shows the function menu for the answering system.
- 6 Press **1**.
 - The current setting is displayed on the base unit.
- 7 Enter a remote code using a **2-digit number (00–99)**.
- 8 Press **FWD/EDIT** **▶** (Save key).
 - A beep sounds.
 - To return to the standby mode, press **FUNCTION/EXIT/CH**.

Ringer volume
▶Program
▼▲ ▶=Yes

▶Save DIRECT#
Set flash time
▼▲ ▶=Yes

Talk switching
▶TAD program
▼▲ ▶=Yes

Answering system setting.
See base unit.

Base unit display
Remote code
:11

Answering System

- If 6 beeps sound during programming, a wrong key was pressed. Enter the correct number.

To check the remote code

Repeat steps 1 to 6.

- The current remote code is displayed on the base unit. When finished, press **FUNCTION/EXIT/CH**.

► Remote Operation from a Touch Tone Phone

Voice Menu

You can operate the answering system only for the line(s) you set to record by following the voice menu. The shaded boxes are voice prompts.

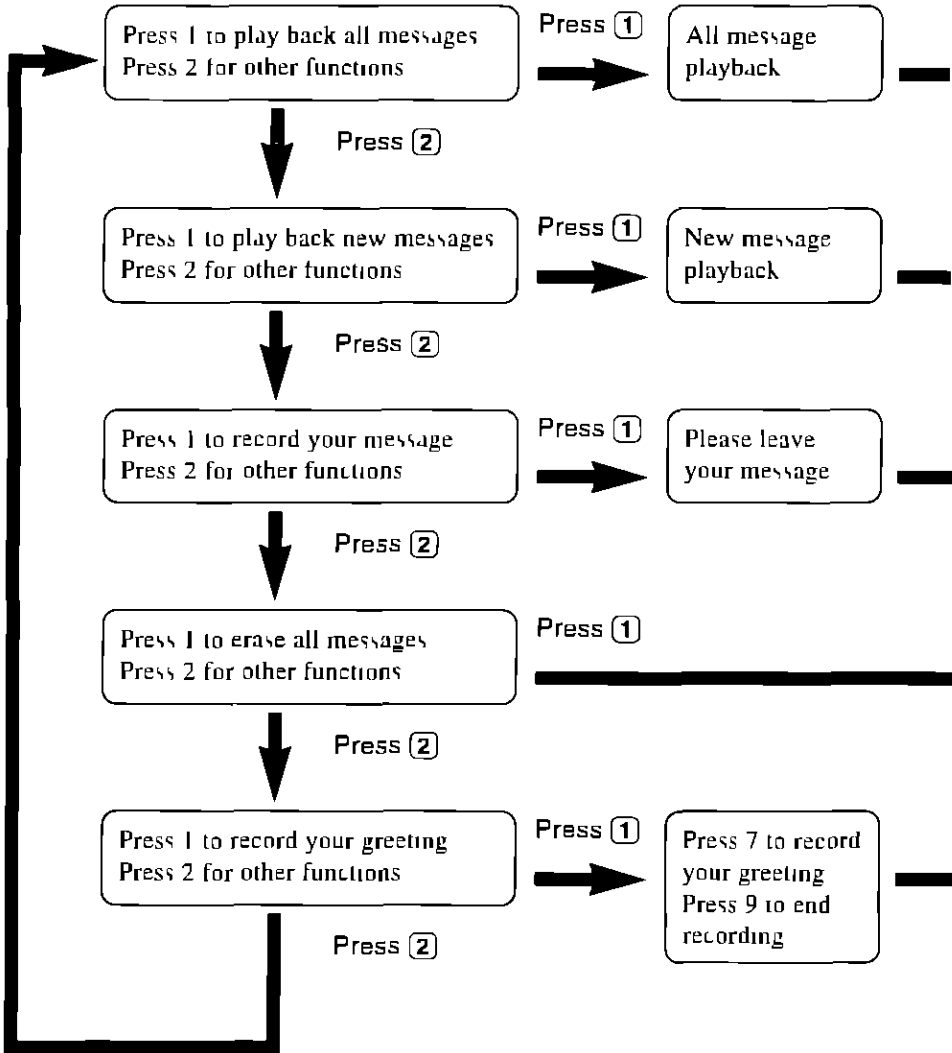



All Message Playback

All recorded messages on the line(s) you set to record are played back. At the end of the last message, "End of final message" is heard. The unit will announce the remaining recording time if it is less than 5 minutes.

New Message Playback

Only new messages on the line(s) you set to record are played back. At the end of the last message, "End of final message" is heard. The unit will announce the remaining recording time if it is less than 5 minutes.

Recording a Memo Message

You can leave a personal message.

- 1 Talk after you hear "Please leave your message"
- 2 When you finish recording, hang up

Erasing All Messages

All recorded messages on the line(s) you set to record (except greeting message) are erased.

Recording a Greeting Message

You can re-record your greeting message on the line(s) for which the answering system is already on.

- 1 Press **7**
You will hear a voice prompt followed by a long beep
- 2 After the beep, talk for up to 2 minutes
- 3 When you finish recording, press **9**
- 4 Your greeting will be played back for confirmation

- 3 seconds after playback, the voice menu will start again from the beginning
- If you hear "Memory full" after playback, erase some, or all, of the messages (p. 79)

► Remote Operation from a Touch Tone Phone

Direct Remote Operation

Once you have entered the remote code, you can also control your unit by direct commands instead of using the voice menu. To end the remote operation, hang up anytime.

Summary of direct remote operation

- 1** Select the desired line(s) after entering your remote code. To use the line(s) for which the answering system is already on, go to step 2.
Press **# 1** to select "LINE 1"
Press **# 2** to select "LINE 2"
Press **# 0** to select "LINE 1 and LINE 2"
 - The number of new messages on the selected line(s) is heard



- 2** Enter the desired direct commands (p. 79, 80)
 - If you do not enter any commands, the voice menu will start (p. 76). You can also follow the voice menu to operate the answering system for the line(s) selected in step 1.
 - If you want to operate another line, repeat from step 1.



- 3** To end remote operation, hang up.
 - The messages are saved.
 - The line(s) that can be answered by the answering system will not change even if you select another line in step 1. To turn on the answering system for another line, see page 80.

- Do not press **#** for a few seconds. Some long distance services use **#** for other purposes and these services may take priority over the remote operation.



Direct commands

NEW MESSAGE PLAYBACK	4	<ul style="list-style-type: none">• Only new messages on the selected line(s) are played back
ALL MESSAGE PLAYBACK	5	<ul style="list-style-type: none">• All messages on the selected line(s) are played back
REPEAT (During playback)	1	<ul style="list-style-type: none">• The current message is repeated
SKIP (During playback)	2	<ul style="list-style-type: none">• The current message is skipped The next message is played
STOP	9	<ul style="list-style-type: none">• Operation is stopped temporarily• To resume operation, enter a direct command within 15 seconds, or the voice menu will start

GREETING MESSAGE RECORDING You can re-recorded your greeting message for the selected line(s)

7

- A long beep sounds



RECORD

- After the beep, talk immediately for up to 2 minutes



9

- The recording is stopped
- The recorded message is played

ERASING A
SPECIFIC
MESSAGE
(During playback)

*** 4**

- The current message is erased
- A short beep will sound and the next message will be played

ERASING ALL
MESSAGES

*** 5**

- All recorded messages on the selected line(s) are erased
- A long beep sounds and "Line 1, no messages" and/or "Line 2, no messages" is/are heard

(continued )

► Remote Operation from a Touch Tone Phone

ANSWERING SYSTEM OFF

0

- "Answer off" is heard
 - The answering system for the selected line(s) is turned off
 - The voice menu will start. To end the remote operation, hang up. To operate the other line or both lines, select the required line(s) (see below), and enter the desired direct commands
-

SELECTING ANOTHER LINE

1

- LINE 1 is selected and the number of new messages on LINE 1 is heard

2

- LINE 2 is selected and the number of new messages on LINE 2 is heard

0

- LINE 1 and LINE 2 are selected and the number of new messages on both lines is heard
-

ANSWERING SYSTEM ON FOR EACH LINE

1 8

- "Answer set line 1" is heard and the LINE 1 answering system is turned on

2 8

- "Answer set line 2" is heard and the LINE 2 answering system is turned on

0 8

- "Answer set line 1 and line 2" is heard and the answering system for both lines is turned on

- If the LINE 1 (LINE 2) answering system is on and you also want to turn on the LINE 2 (LINE 1) answering system, press **# 0 8**
-

Turning on the answering system

Call your unit and wait for 15 rings

- The unit will answer and the greeting message will be played
- The answering system will turn on. Hang up or enter the remote code for other options
- When turning on the answering system using a rotary or pulse service telephone, you cannot enter the remote code for other options

Skipping the greeting message

After calling your unit, press ***** during the greeting message

- The unit skips the rest of the greeting message and you can start recording your message after the long beep

Remote Operation with the Handset

You can operate your answering system with the handset

The announcements and recorded messages can only be heard with the handset

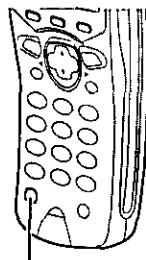

FLASH/CALL WAIT/PLAYBACK

Summary of remote operation

Press **FLASH/CALL WAIT/PLAYBACK**

- The unit announces the line(s) for which the answering system is on and the number of new messages on the line(s)
- "Remote operation" is displayed on the handset



1 Select the desired line(s) To use the line(s) for which the answering system is already on, go to step 2

Press **# 1** to select "LINE 1"

Press **# 2** to select "LINE 2"

Press **# 0** to select "LINE 1 and LINE 2"

- The number of new messages on the selected line(s) is heard

2 Enter the desired direct commands (p 82, 83)

- If you want to operate another line, repeat from step 1

- If you do not enter a command, the voice menu will start (see next page)
- After the voice menu, all message playback on the selected line(s) will start



To end remote operation, press **FLASH/CALL WAIT/PLAYBACK**

- The messages are saved
- The line(s) that can be answered by the answering system will not change even if you select another line in step 1 To turn on the answering system for another line, see page 83

- The unit will announce the remaining recording time after playback, if it is less than 5 minutes
- If two tones sound during the remote operation, an incoming call has been received To answer with the handset, press the line button whose status icon is flashing quickly The remote operation is ended
- If you hear "Memory full" after playback, erase some, or all, of the messages (p 82)

► Remote Operation with the Handset

Voice menu

If no commands are entered after you press

(FLASH/CALL WAIT/PLAYBACK), the unit will start the following voice menu

“Press 4 to play back new messages Press 5 to play back all messages”

- You can enter direct commands even if the voice menu has started

Direct commands

NEW MESSAGE PLAYBACK	4	<ul style="list-style-type: none">▪ Only new messages on the selected line(s) are played back
ALL MESSAGE PLAYBACK	5	<ul style="list-style-type: none">▪ All messages on the selected line(s) are played back
REPEAT (During playback)	1	<ul style="list-style-type: none">▪ The current message is repeated
SKIP (During playback)	2	<ul style="list-style-type: none">▪ The current message is skipped The next message is played
STOP	9	<ul style="list-style-type: none">▪ Operation is stopped temporarily▪ To resume operation, enter a direct command within 15 seconds, or the above voice menu will start
ERASING A SPECIFIC MESSAGE (During playback)	* 4	<ul style="list-style-type: none">▪ The current message is erased▪ A short beep will sound and the next message will be played
ERASING ALL MESSAGES	* 5	<ul style="list-style-type: none">▪ All recorded messages on the selected line(s) are erased▪ A long beep sounds and “Line 1, no messages” and/or “Line 2, no messages” is/are heard
ANSWERING SYSTEM ON	8	<ul style="list-style-type: none">▪ “Answer set” is heard▪ The answering system for the selected line(s) is turned on

ANSWERING
SYSTEM OFF

0

- "Answer off" is heard
- The answering system for the selected line(s) is turned off
- The voice menu will start To end the remote operation, press **FLASH/CALL WAIT/PLAYBACK**
To operate the other line or both lines, select the required line(s) (see below), and enter the desired direct commands

SELECTING
ANOTHER LINE

1

- LINE 1 is selected and the number of new messages on LINE 1 is heard

2

- LINE 2 is selected and the number of new messages on LINE 2 is heard

0

- LINE 1 and LINE 2 are selected and the number of new messages on both lines is heard

ANSWERING
SYSTEM ON
FOR EACH LINE

1 8

- "Answer set line 1" is heard and the LINE 1 answering system is turned on

2 8

- "Answer set line 2" is heard and the LINE 2 answering system is turned on

0 8

- "Answer set line 1 and line 2" is heard and the answering system for both lines is turned on

- If the LINE 1 (LINE 2) answering system is on and you also want to turn on the LINE 2 (LINE 1) answering system, press **# 0 8**

Wall Mounting

This unit can be mounted on a wall phone plate

- 1 Set the handset holder as shown

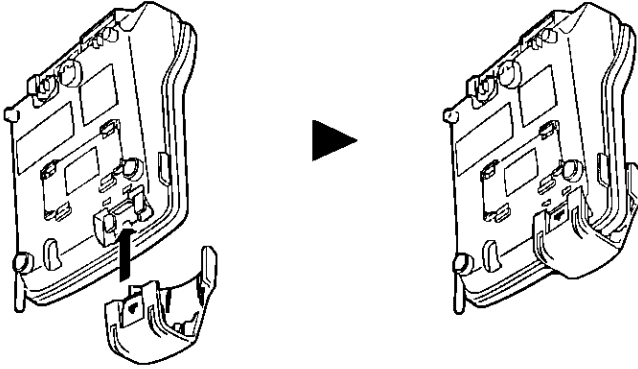

- 2 Connect the AC adaptor

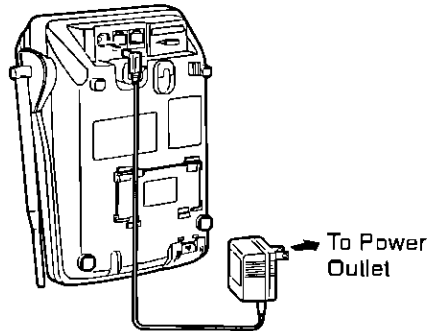

- 3 Tuck the telephone line cord inside the wall mounting adaptor, then push it in the direction of the arrow
- The word "UP" should face upward

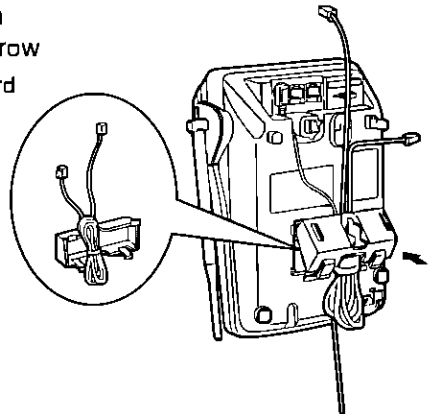

4 Connect the telephone line cord Mount the unit, then slide down

- Raise the antenna

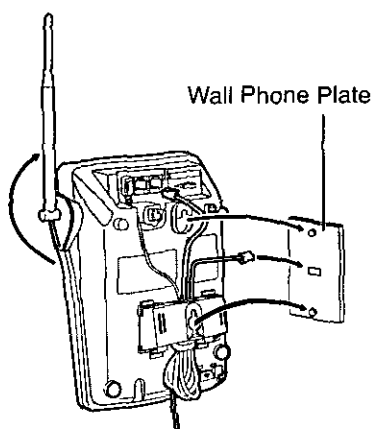

5 To charge the battery: Place the handset on the handset holder as shown

- The IN USE/CHARGE indicator lights

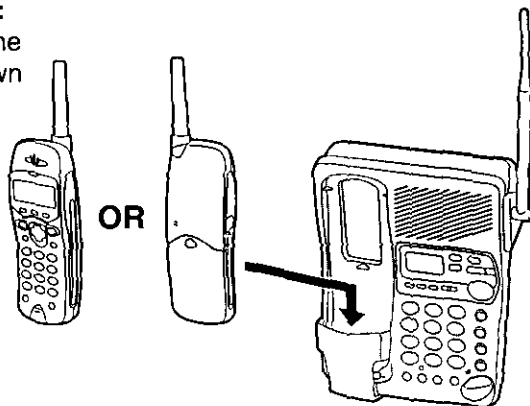

To remove the handset holder

While pressing the arrow (①) and opposite side (②) of the holder, pull out the handset holder

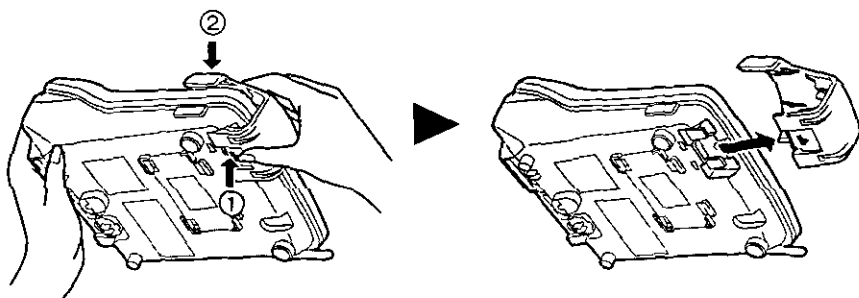

Battery Replacement

If "Recharge battery" is displayed and/or "[■]" flashes after being fully charged, replace the battery with a new Panasonic P-P50B battery. To order, call the accessories telephone number on page 2.

- 1 Press the notch on the battery cover firmly and slide it as indicated by the arrow
- 2 Replace the battery and close the cover
- 3 Make sure you charge the new battery for about 6 hours in order to display the battery strength prompt correctly (p. 16)

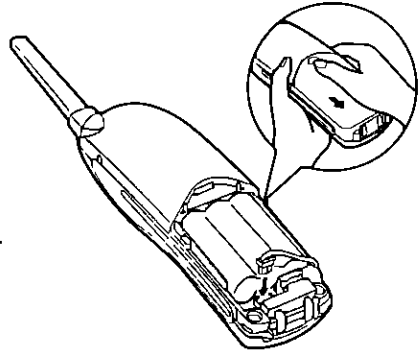

Attention:

The product you have purchased is powered by a nickel cadmium battery which is recyclable. At the end of its useful life, under various state and local laws, it is illegal to dispose of this battery into your municipal waste stream. Please call 1-800-8-BATTERY for information on how to recycle this battery.



Adding Another Phone

This unit will not function during a power failure. To connect a standard telephone on the same line, use the Panasonic T-adaptor KX-J66. To order, call the accessories telephone number on page 2.

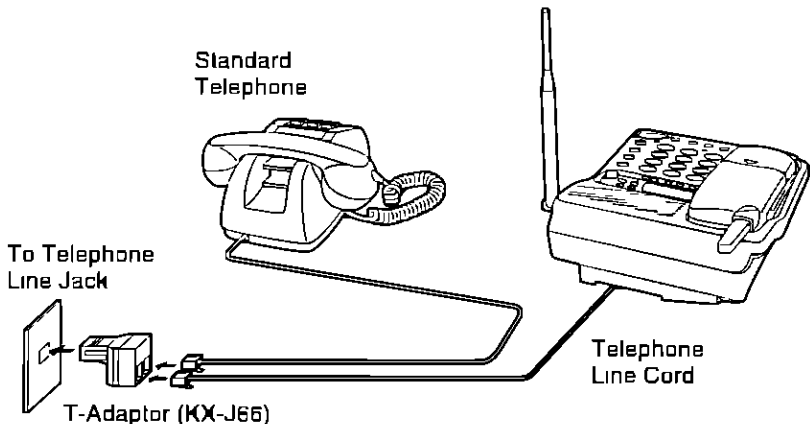

Before Requesting Help



Cordless Telephone

Problem	Cause and Remedy
"No link to base Place on cradle and try again " is displayed and an alarm tone sounds	<ul style="list-style-type: none">• You are too far from the base unit Move closer and try again• Place the handset on the base unit and try again• Plug in the AC adaptor• Raise the base unit antenna
Static, sound cuts in/out, fades Interference from other electrical units	<ul style="list-style-type: none">• Locate the handset and the base unit away from other electrical appliances (p 3)• Move closer to the base unit• Raise the base unit antenna• Press FUNCTION/EXIT/CH to select a clearer channel
The handset does not ring	<ul style="list-style-type: none">• The ringer volume is set to OFF Select the ringer volume again (p 23)
The base unit does not ring	<ul style="list-style-type: none">• The ringer volume is set to OFF Press RINGER/CONF then the line button while the unit is in the standby mode (p 24)
The line status icons and/or buttons do not work properly	<ul style="list-style-type: none">• Check the settings (p 13–20)• The line mode selection is incorrect See page 19
The handset display is blank	<ul style="list-style-type: none">• The handset is in the standby mode (p 17) Press ▼, ▲, BACK ◀ or FWD/EDIT ▶ to turn the display on
The handset display is still blank after pressing ▼ , ▲ , BACK ◀ or FWD/EDIT ▶	<ul style="list-style-type: none">• Charge the battery fully (p 16)
Speech is cut off in places during a conversation using the speakerphone	<ul style="list-style-type: none">• If another call is received on the other line, the conversation will be interrupted in order to receive the Caller ID information

► Before Requesting Help

Problem	Cause and Remedy
You cannot store a name and phone number in the directory	<ul style="list-style-type: none">▪ You cannot store an item in the directory while the unit is in the talk or intercom mode, or while the answering system is in use▪ Do not pause for over 60 seconds while storing
While programming or searching, the unit starts to ring and stops the program/search	<ul style="list-style-type: none">▪ To answer the call, press TALK, DIGITAL SP-PHONE or the relevant line button. Start again from the beginning after hanging up
During a conversation, the other line status icon/button flashes quickly and the display shows another caller's information	<ul style="list-style-type: none">▪ Someone is calling you on the other line. To answer, press INTERCOM/HOLD/CLEAR or LOCATOR/INTERCOM/HOLD to put the current call on hold. Press the line button on the handset whose status icon is flashing quickly or the line button on the base unit which is flashing quickly (p. 59)
The unit does not display the caller's name and/or phone number	<ul style="list-style-type: none">▪ You do not subscribe to a Caller ID service▪ Other telephone equipment may be interfering with your phone. Disconnect it and try again▪ Other electrical appliances connected to the same outlet may be interfering with the Caller ID information▪ Telephone line noise may be affecting the Caller ID information
A call was received, but the caller's information was not stored in the Caller List	<ul style="list-style-type: none">▪ If you receive two calls at the same time, only one of the caller's information can be stored
The handset display goes to the standby mode while viewing the Caller List	<ul style="list-style-type: none">▪ Do not pause for over 60 seconds while searching



Problem	Cause and Remedy
LOCATOR/INTERCOM/HOLD does not function	<ul style="list-style-type: none">• The handset is too far from the base unit• The handset is engaged in an outside call or is viewing the Caller List/directory list Wait until the IN USE/CHARGE indicator light goes out
You cannot redial by pressing REDIAL/PAUSE	<ul style="list-style-type: none">• If the last number dialed was more than 32 digits long, the number will not be redialed correctly• Access numbers entered after pressing -tone will not be included when redialing
You cannot have a conversation using the handset	<ul style="list-style-type: none">• When an optional headset is connected (p 20), you must use the headset to talk with the caller To have a normal cordless phone conversation, disconnect the headset
You cannot have a conversation using the headset	<ul style="list-style-type: none">• Make sure that an optional headset is connected properly (p 20)

Answering System

Problem	Cause and Remedy
The answering system is on, but incoming messages are not recorded	<ul style="list-style-type: none">• The recording time is set to "Greeting only" Select "1 minute" or "3 minutes" (p 30)• Memory is full Erase some, or all, of the messages (p 73)• You are answering the other line with the speakerphone, or the answering system is in use (recording a message, playing back a message, etc) Hang up the first call or stop using the answering system

Useful Information

► Before Requesting Help

Problem	Cause and Remedy
You cannot listen to the recorded messages	<ul style="list-style-type: none">● Make sure that the base unit is in the standby mode (p 17)
“Message full” is displayed and the ANSWER ON indicator flashes rapidly, and no new messages are recorded	<ul style="list-style-type: none">● Memory is full Erase some, or all, of the messages (p 73)
You cannot operate the answering system at the base unit	<ul style="list-style-type: none">● The handset user is operating the answering system Wait until the IN USE/CHARGE indicator light goes out
You cannot operate the answering system from a touch tone phone	<ul style="list-style-type: none">● Make sure you enter the correct remote code● The answering system may not respond if the tones are too short to activate the unit Press each button firmly● The answering system is off Turn it on (p 80)
You cannot operate the answering system with the handset	<ul style="list-style-type: none">● Someone is operating the answering system● You are too far from the base unit Move closer to the base unit● The unit is recording a message To answer the call, press the line button whose status icon is displayed
While recording a greeting message, the unit starts to ring and stops recording	<ul style="list-style-type: none">● To answer the call, press DIGITAL SP-PHONE, TALK or the relevant line button Start again from the beginning after hanging up
During playback, the unit starts to ring and stops playback	<ul style="list-style-type: none">● To answer the call, press DIGITAL SP-PHONE, TALK or the relevant button To resume playback, press NEW MESSAGE after hanging up

General

Problem	Cause and Remedy
The unit does not work	<ul style="list-style-type: none">● Check the settings (p 13–20)● Charge the battery fully (p 16)● Clean the charge contacts and charge again (p 17)● Install the battery properly (p 16, 86)● Place the handset on the base unit and unplug the AC adaptor to reset Plug in, and try again
You cannot program items, such as the dialing mode	<ul style="list-style-type: none">● Programming is not possible while the unit is in the talk or speakerphone mode, when viewing the Caller List/directory list, or while the answering system is in use● Do not pause for over 60 seconds while programming● Move closer to the base unit
Previously programmed information is erased	<ul style="list-style-type: none">● If a power failure occurs, programmed information may be erased Reprogram if necessary
“Recharge battery” is displayed, “{ ■ ” flashes or the unit beeps intermittently	<ul style="list-style-type: none">● Charge the battery fully (p 16)
You charged the battery fully, but “Recharge battery” is still displayed and/or “{ ■ ” continues to flash	<ul style="list-style-type: none">● Clean the charge contacts and charge again (p 17)● Install a new battery (p 86)
The IN USE/CHARGE indicator light does not go out while charging	<ul style="list-style-type: none">● This is normal
If you cannot solve your problem	<ul style="list-style-type: none">● Call our customer call center at 1-800-211-PANA(7262)● Panasonic’s e-mail address for customer inquiries consumerproducts@panasonic.com for customers in the USA or Puerto Rico ONLY

Important Safety Instructions

When using this unit, basic safety precautions should always be followed to reduce the risk of fire, electric shock, or personal injury

- 1 Read and understand all instructions
- 2 Follow all warnings and instructions marked on this unit
- 3 Unplug this unit from AC outlets before cleaning. Do not use liquid or aerosol cleaners. Use a damp cloth for cleaning.
- 4 Do not use this unit near water, for example, near a bathtub, washbowl, kitchen sink, or the like.
- 5 Place this unit securely on a stable surface. Serious damage and/or injury may result if the unit falls.
- 6 Do not cover slots and openings on the unit. They are provided for ventilation and protection against overheating. Never place the unit near radiators, or in a place where proper ventilation is not provided.
- 7 Use only the power source marked on the unit. If you are not sure of the type of power supplied to your home, consult your dealer or local power company.
- 8 Do not place objects on the power cord. Install the unit where no one can step or trip on the cord.
- 9 Do not overload wall outlets and extension cords. This can result in the risk of fire or electric shock.
- 10 Never push any objects through slots in this unit. This may result in the risk of fire or electric shock. Never spill any liquid on the unit.
- 11 To reduce the risk of electric shock, do not disassemble this unit. Take the unit to an authorized servicer when service is required. Opening or removing covers may expose you to dangerous voltages or other risks. Incorrect reassembly can cause electric shock when the unit is subsequently used.
- 12 Unplug this unit from the wall outlet and refer servicing to an authorized servicer when the following conditions occur:
 - A When the power supply cord or plug is damaged or frayed
 - B If liquid has been spilled into the unit
 - C If the unit has been exposed to rain or water
 - D If the unit does not work normally by following the operating instructions. Adjust only controls covered by the operating instructions. Improper adjustment may require extensive work by an authorized servicer.
 - E If the unit has been dropped or physically damaged
 - F If the unit exhibits a distinct change in performance
- 13 During thunderstorms, avoid using telephones except cordless types. There may be a remote risk of an electric shock from lightning.
- 14 Do not use this unit to report a gas leak, when in the vicinity of the leak.

SAVE THESE INSTRUCTIONS

CAUTION:

To reduce the risk of fire or injury to persons, read and follow these instructions

- 1 Use only the battery(ies) specified
- 2 Do not dispose of the battery(ies) in a fire. They may explode. Check with local waste management codes for special disposal instructions
- 3 Do not open or mutilate the battery(ies). Released electrolyte is corrosive and may cause burns or injury to the eyes or skin. The electrolyte may be toxic if swallowed
- 4 Exercise care in handling batteries in order not to short the battery to conductive materials such as rings, bracelets, and keys. The battery and/or conductor may overheat and cause burns
- 5 Charge the battery(ies) provided with or identified for use with this product only in accordance with the instructions and limitations specified in this manual

WARNING:

TO PREVENT FIRE OR SHOCK HAZARD, DO NOT EXPOSE THIS PRODUCT TO RAIN OR ANY TYPE OF MOISTURE

- The AC adaptor is used as the main disconnect device, ensure that the AC outlet is located/installed near the unit and is easily accessible

FCC and Other Information

If requested by the telephone company, inform them as follows

FCC Registration No (found on the bottom of the unit)

Ringer Equivalence

0 2B

The particular telephone lines to which the equipment is connected

This unit must not be connected to a coin operated line

If you are on a party line, check with your local telephone company

Ringer Equivalence No (REN)

The REN is useful in determining the quantity of devices you may connect to your telephone line and still have all of those devices ring when your telephone number is called. In most, but not all areas, the sum of the REN's of all devices connected to one line should not exceed five (5.0). To be certain of the number of devices you may connect to your line, as determined by the REN, you should contact your local telephone company to determine the maximum REN for your calling area.

In the event terminal equipment causes harm to the telephone network, the telephone company should notify the customer, if possible, that service may be stopped.

However, where prior notice is impractical, the company may temporarily cease service providing that they

- (a) Promptly notify the customer
- (b) Give the customer an opportunity to correct the problem with their equipment
- (c) Inform the customer of the right to bring a complaint to the Federal Communication Commission pursuant to procedures set out in FCC Rules and Regulations Subpart E of Part 68

The Telephone Company may make changes in its communications facilities, equipment, operations or procedures, where such action is reasonably required in the operation of its business and is not inconsistent with the rules and regulations in FCC Part 68.

If such changes can be reasonably expected to render any customer terminal equipment incompatible with telephone company communications facilities, or require modification or alteration of such terminal equipment, or otherwise materially affect its use or performance, the customer shall be given adequate notice in writing, to allow the customer an opportunity to maintain uninterrupted service.

When programming emergency numbers and/or making test calls to emergency numbers

1. Remain on the line and briefly explain to the dispatcher the reason for the call before hanging up
2. Perform such activities in the off-peak hours, such as early morning hours or late evenings

This device complies with Part 15 of the FCC Rules. Operation is subject to the following two conditions: (1) This device may not cause harmful interference, and (2) this device must accept any interference received, including interference that may cause undesired operation.

Privacy of communications may not be ensured when using this phone

CAUTION

Any changes or modifications not expressly approved by the party responsible for compliance could void the user's authority to operate this device

Note

This equipment has been tested and found to comply with the limits for a Class B digital device, pursuant to Part 15 of the FCC Rules. These limits are designed to provide reasonable protection against harmful interference in a residential installation. This equipment generates, uses, and can radiate radio frequency energy and, if not installed and used in accordance with the instructions, may cause harmful interference to radio communications. However, there is no guarantee that interference will not occur in a particular installation. If this equipment does cause harmful interference to radio or television reception, which can be determined by turning the equipment off and on, the user is encouraged to try to correct the interference by one or more of the following measures:

- Reorient or relocate the receiving antenna
- Increase the separation between the equipment and receiver
- Connect the equipment into an outlet on a circuit different from that to which the receiver is connected
- Consult the dealer or an experienced radio/TV technician for help

Some cordless telephones operate at frequencies that may cause interference to nearby TVs and VCRs. To minimize or prevent such interference, the base of the cordless telephone should not be placed near or on top of a TV or VCR. If interference is experienced, move the cordless telephone further away from the TV or VCR. This will often reduce, or eliminate, interference.

- **Environment**—do not place the unit in a room where the temperature is less than 5°C (41°F) or greater than 40°C (104°F). Allow 10 cm (4") clearance around the unit for proper ventilation. Avoid excessive smoke, dust, mechanical vibration, shock, or direct sunlight.
- **Medical**—consult the manufacturer of any personal medical devices, such as pacemakers, to determine if they are adequately shielded from external RF (radio frequency) energy. (The unit operates in the frequency range of 905MHz to 925MHz and the power output level can range from 0.001 watts to 0.1 watts.) Do not use the unit in health care facilities if any regulations posted in the area instruct you not to do so. Hospitals or health care facilities may be using equipment that could be sensitive to external RF (radio frequency) energy.
- **Routine care**—wipe the unit with a soft cloth. Do not use benzine, thinner, or any abrasive powder. When you leave the unit unused for a long period of time, unplug the AC adaptor from the outlet.
- **If there is any trouble**—disconnect the unit from the telephone line and connect a known working phone. If the known working phone operates properly, have your unit repaired by one of the authorized Panasonic Factory Service Centers. If the known working phone does not operate properly, consult your telephone company.

For product service

- Panasonic Servicenters are listed in the servicenter directory
- Call 1-800-211-PANA(7262) for the location of an authorized servicenter
- Panasonic's e-mail address for customer inquiries
consumerproducts@panasonic.com
for customers in the USA or Puerto Rico ONLY

When you ship the product

- Carefully pack your unit, preferably in the original carton
- Attach a letter, detailing the symptom, to the outside of the carton

Symptom

- Send the unit to an authorized servicenter, prepaid and adequately insured
- Do not send your unit to the Panasonic Consumer Electronics Company listed below or to executive or regional sales offices. These locations do not repair consumer products

- This cordless telephone is designed for use in the United States of America. Sale or use of this product in other countries may violate local laws.
- Ce téléphone sans fil est conçu pour être utilisé aux États-Unis d'Amérique. La vente ou l'emploi de cet appareil dans certains autres pays peut constituer une infraction à la législation locale.
- Este teléfono sin cordón fue elaborado para uso en los Estados Unidos de América. La venta o el empleo de este producto en ciertos países puede constituir violación de la legislación local.
- このコードレス電話機は、日本国外での使用を目的として設計されており、日本国内での使用は法律違反となります。従って、当社では日本国内においては原則として修理などのサービスは致しかねます。

**Panasonic Consumer Electronics Company,
Division of Matsushita Electric Corporation of America**
One Panasonic Way, Secaucus, New Jersey 07094

**Panasonic Sales Company,
Division of Matsushita Electric of Puerto Rico, Inc**
Ave 65 de Infantería, Km 9.5, San Gabriel Industrial Park
Carolina, Puerto Rico 00985

Free Manuals Download Website

<http://myh66.com>

<http://usermanuals.us>

<http://www.somanuals.com>

<http://www.4manuals.cc>

<http://www.manual-lib.com>

<http://www.404manual.com>

<http://www.luxmanual.com>

<http://aubethermostatmanual.com>

Golf course search by state

<http://golfingnear.com>

Email search by domain

<http://emailbydomain.com>

Auto manuals search

<http://auto.somanuals.com>

TV manuals search

<http://tv.somanuals.com>