

Panasonic

Digital Cordless Answering System

Operating Instructions

Model No. **KX-TCD545E**

Preparation

Telephone System

Answering System

Useful Information

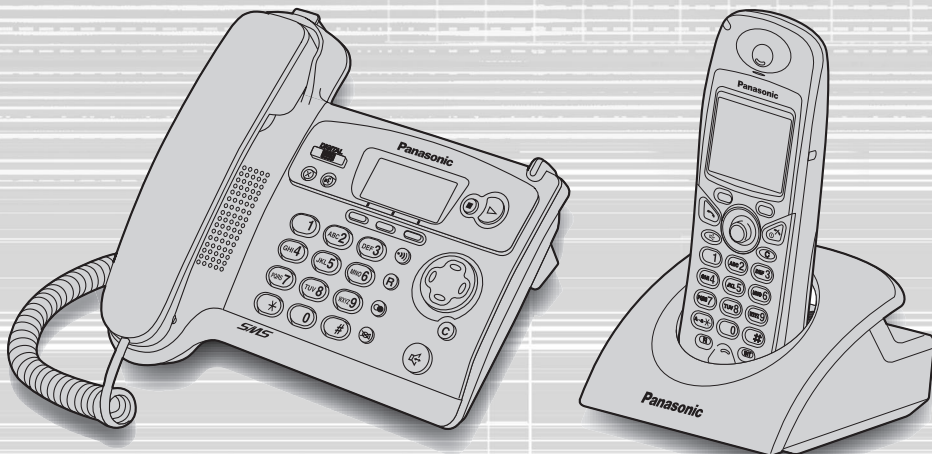

SMS

Caller ID and SMS Compatible

Caller ID and SMS Services, where available, are network provider services. After subscribing to Caller ID, this phone will display the caller's phone number.

Please read these Operating Instructions before using the unit and save for future reference.

Charge the batteries for about 7 hours before initial use.

Download from www.Somanuals.com. All Manuals Search And Download.

Before Initial Use

◆◆ Features



Digital Answering System

Up to 30 minutes recording time or up to 64 messages, with time/day stamp that records when messages were received and counts the total number.



SMS (Short Message Service) compatibility

Now the convenience of sending and receiving text messages performed with the cordless handset is available from a home telephone.



Polyphonic Ringer Tones for Cordless Handset

A variety of high-quality sounds can be reproduced for your ringer tones.

You can choose from 9 pre-set melodies and 6 ringer tones.



Hands-Free Speakerphone

You can talk without holding cordless handset.

Convenient for talking while doing something else.

This feature is also available for the base unit.



Headset Socket

Plug in the optional headset for hands-free ease and freedom of use.



Illuminated Keypad

Lights up when there is an incoming call or any time you touch a key for easy operation even in the dark.



200+20-Station Phonebook

Store up to 200 (for Handset Phonebook) plus 20 (for Base Unit Phonebook) names and numbers in the built-in telephone directory for easy access.



Multiple Cordless Handsets

Up to 6 cordless handsets can be registered with a single base unit for added convenience. (Optional cordless handset/charger is available separately.)





Voice Search

You can record up to 20 voice tags for the handset phonebook items, then you can search an item in the handset phonebook with your voice.

◆◆ Contents



Preparation	
Before Initial Use.....	2
Important Information.....	6
Location of Controls.....	7
Icons above the SOFT KEYS.....	10
Symbols Used for Operations.....	11
Display.....	13
Setting up.....	15
Telephone System	
Using the Telephone.....	21
Caller ID.....	30
List Menu.....	32
Using the Phonebook.....	36
Voice Search for the Handset	
Phonebook.....	48
Phonebook Copy.....	50
SMS Feature (Text Message).....	52
Settings Menu Chart.....	64
Handset Settings.....	66
Base Unit Settings.....	77
Operations Performed with the	
Base Unit.....	82
Multi-Unit User Operations.....	88
Walkie-Talkie.....	97
Answering System	
Answering System.....	100
Useful Information	
Using the Belt Clip.....	114
Optional Headset.....	114
Desktop Use.....	115
Wall Mounting.....	117
Before Requesting Help.....	120
Character Table.....	124
Index.....	126
Technical Information.....	127
Guarantee.....	128



For your information

Throughout these Operating Instructions,  and  are used to indicate with which unit an operation can be performed.

: Perform with cordless handset.

: Perform with the base unit.

 : Perform with the cordless handset or base unit separately.

 & : Perform with the cordless handset and base unit together.

Before Initial Use

Thank you for purchasing your new Panasonic digital cordless telephone.

Sales and Support Information Customer Care Centre

- For UK customers: **08700 100 076**
- For Republic of Ireland customers:
01289 8333
- Visit our website for product information:
<http://www.panasonic.co.uk>
- E-mail:
customer.care@panasonic.co.uk

Direct Sales at Panasonic UK

- Order accessory and consumable items for your product with ease and confidence by phoning our Customer Care Centre Monday - Friday
9:00am - 5:30pm.
(Excluding public holidays)
Or go order online with our Internet Accessory ordering application available at Shop@Panasonic **<http://www.panasonic.co.uk>**
- Most major credit and debit cards accepted.
- All enquiries transactions and distribution facilities are handled directly by Panasonic UK Ltd.
- It couldn't be simpler!
- Browse or order a wide range of Panasonic products online!
Visit **<http://www.panasonic.co.uk>** for details.





Dear purchaser,

You have acquired a KX-TCD545E, which is a product made in accordance with the Digital Enhanced Cordless Telecommunications (DECT). DECT technology is characterized by high-security protection against interceptions as well as high-quality digital transmission. This telephone was designed for a wide range of applications. For example, this telephone can be used within a network of base units and cordless handsets, constituting a telephone system which:

- operates up to 6 cordless handsets at one base unit.
- allows an intercom between 2 registered units.
- allows the operation of a cordless handset at up to 4 base units, expanding the communication radio area.

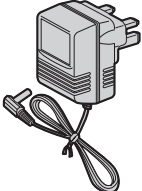
Caller ID and SMS Services, where available, are network provider services. After subscribing to Caller ID, this phone will display the caller's phone number.

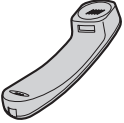
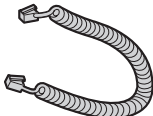
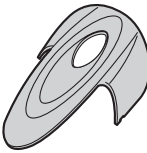
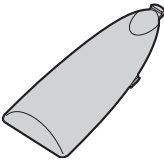
Accessories (specific to product type)

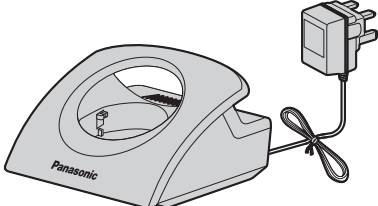
<input type="checkbox"/> AC Adaptor (for Base Unit) Order No. PQLV19EZ (PQLV19E)  <p style="text-align: right;">one</p>	<input type="checkbox"/> Telephone Line Cord Order No. PQJA87S (for UK)  <p style="text-align: right;">one</p>	<input type="checkbox"/> Handset Order No. PQJXH0128Y  <p style="text-align: right;">one</p>
<input type="checkbox"/> Handset Cord Order No. PQJA212K  <p style="text-align: right;">one</p>	<input type="checkbox"/> Belt Clip Order No. PQKE10355Z1 (Metallic Grey)  <p style="text-align: right;">one</p>	<input type="checkbox"/> Battery Cover Order No. PQKK10134Y6 (Metallic Grey)  <p style="text-align: right;">one</p>
<input type="checkbox"/> Rechargeable Batteries (AAA size) Order No. HHR-4EPT/BA2 (P03P)  <p style="text-align: right;">two</p>	<input type="checkbox"/> Charger Unit AC Adaptor (for Charger): Order No. PQLV200EZ (PQLV200E) Charger: Order No. PQLV30018ZM1  <p style="text-align: right;">one</p>	

Operating Instructions...one

Quick Guide.....one

Important Information

Use only the power supply included with the product.

Do not connect the AC adaptor to any AC outlet other than the standard AC220-240 V.

(For Base Unit)

The apparatus is approved for use with PQLV19E (Order No. PQLV19EZ) power supply.

(For Charger)

The apparatus is approved for use with PQLV200E (Order No. PQLV200EZ) power supply.

This apparatus is unable to make calls under the following conditions:

- The portable cordless handset batteries need recharging, or have failed.
- During a mains power failure.
- When the Key Lock is set to ON.
- When the unit is in Call Bar mode (only the emergency Numbers can be made).

Do not open the base unit, cordless handset or charger (other than to change the batteries).

This apparatus should not be used near emergency/intensive care medical equipment and should not be used by people with pacemakers.

Care should be taken that objects do not fall onto, and liquids are not spilled into the unit. Do not subject this unit to excessive smoke, dust, mechanical vibration or shock.

Environment

Do not use this unit near water.

This unit should be kept away from heat sources such as radiators, cookers, etc. It should also not be placed in rooms where the temperature is less than 5 °C or greater than 40 °C.

The AC adaptor is used as the main disconnect device. Ensure that the AC outlet is located/installed near the unit and is accessible.

WARNING:

TO PREVENT THE RISK OF ELECTRICAL SHOCK, DO NOT EXPOSE THIS PRODUCT TO RAIN OR ANY OTHER TYPE OF MOISTURE.

Battery Caution

1. Use only the specified batteries.
2. **Use only rechargeable batteries.**
3. Do not mix old and new batteries.
4. Do not dispose of batteries in a fire, as they may explode.
Check local waste management codes for special disposal instructions.
5. Do not open or mutilate the batteries.
Released electrolyte from the batteries is corrosive and may cause burns or injury to the eyes or skin.
The electrolyte may be toxic if swallowed.
6. Exercise care in handling the batteries in order not to short circuit the batteries with conductive materials such as rings, bracelets and keys.
The batteries and/or conductor may overheat and cause burns.
7. Charge the batteries in accordance with the information provided in this operating guide.

Location

- For maximum distance and noise-free operation, place your base unit:
 - Away from electrical appliances such as TVs, radios, personal computers or other phones.
 - In a convenient, high, and central location.

◆◆ Cordless Handset

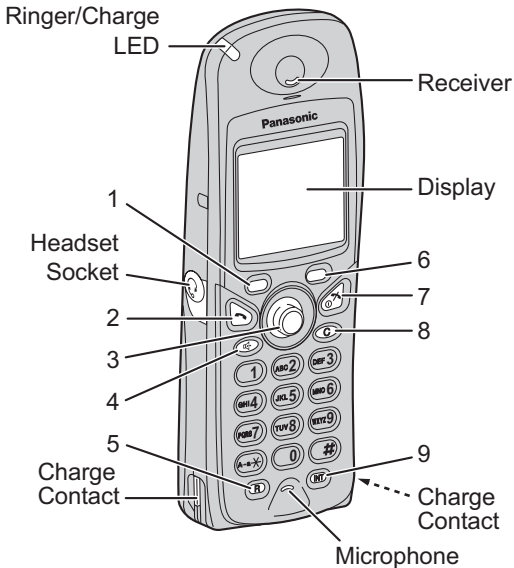

- 1 - ○ LEFT SOFT KEY
- 2 - TALK Button
- 3 - JOYSTICK
- 4 - SPEAKERPHONE Button
- 5 - RECALL Button
- 6 - ○ RIGHT SOFT KEY
- 7 - POWER/TALK OFF Button
- 8 - CLEAR Button
- 9 - INTERCOM/HOLD Button

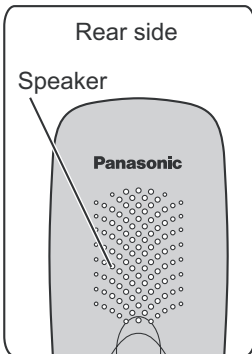

How to Use the Cordless Handset Soft Keys

The 3 soft keys are used to select functions displayed directly above the keys.

Functions displayed above the keys will change depending on the state of use.

For example, on the standby mode display, "", "" and "" are displayed above the soft keys.

Example: Standby Mode Display

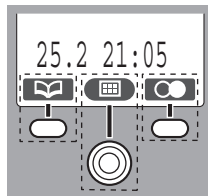

To operate "" (Phonebook), press **LEFT SOFT KEY**.

To operate "" (Menu), press the centre of the **JOYSTICK**, used as the middle soft key.

To operate "" (Redial), press **RIGHT SOFT KEY**.

When "" is displayed above a soft key, the soft key has no function.

- "" (Menu) can be selected when in the standby mode by moving **JOYSTICK** up, down, left or right.

Location of Controls

◆◆ Base Unit

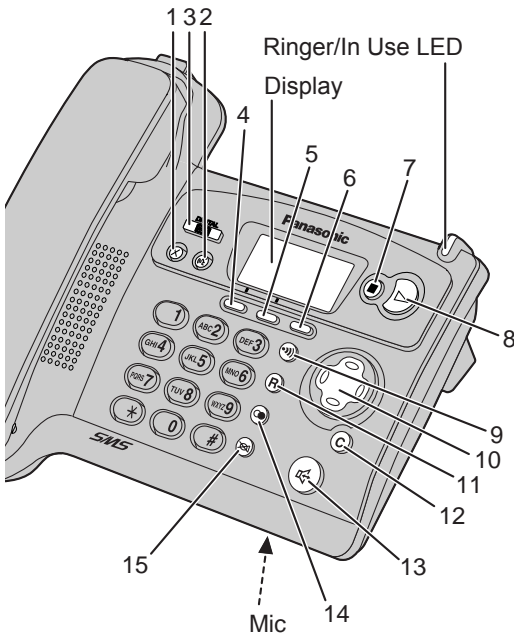

- 1 - **ERASE** Button
- 2 - **GREETING** Button
- 3 - **ANSWER ON** Button and Indicator
- 4 - **LEFT SOFT KEY**
- 5 - **MIDDLE SOFT KEY**
- 6 - **RIGHT SOFT KEY**
- 7 - **STOP** Button
- 8 - **PLAYBACK** Button
- 9 - **PAGE/INTERCOM/HOLD** Button
- 10 - **NAVIGATOR KEY**
- 11 - **RECALL** Button
- 12 - **CLEAR** Button
- 13 - **SPEAKERPHONE** Button
- 14 - **REDIAL** Button
- 15 - **MUTE** Button

How to Use the Base Unit Soft Keys

The 3 soft keys are used to select functions displayed directly above the keys. Functions displayed above the keys will change depending on the state of use. For example, on the standby mode display, , and are displayed above the soft keys.

Example: Standby Mode Display

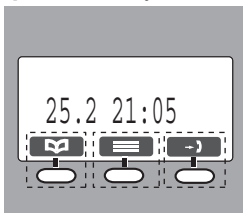

To operate (Phonebook), press **LEFT SOFT KEY**.

To operate (Menu), press **MIDDLE SOFT KEY**.

To operate (Caller ID List), press **RIGHT SOFT KEY**.

When is displayed above a soft key, the soft key has no function.

How to Use the Navigator Key

This key has four active areas.

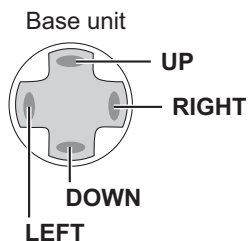





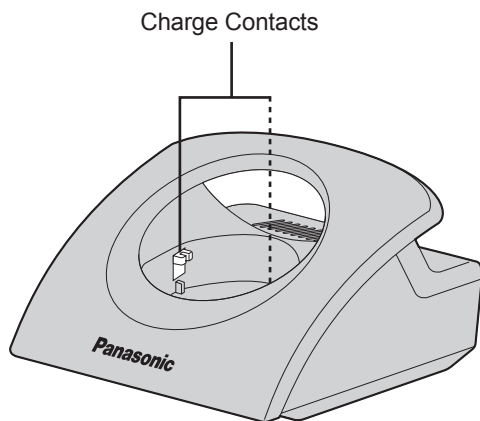

















UP	<ul style="list-style-type: none">• Scrolls up through the function menu, Caller List and the Base Unit Phonebook.• Increases the volume.
DOWN	<ul style="list-style-type: none">• Scrolls down through the function menu, Caller List and the Base Unit Phonebook.• Decreases the volume.
RIGHT	<ul style="list-style-type: none">• Selects your menu choices.
LEFT	<ul style="list-style-type: none">• Returns to the previous display.

◆◆ Charger













Icons above the SOFT KEYS

◆◆ Icons above the Cordless Handset Soft Keys







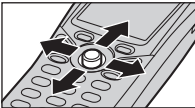

Icons	Functions	Icons	Functions
	Go Back		LetterWise®
	Menu		Alphabet
	Sub-Menu		Numeric
	OK		Greek
	Redial		Extended 1
	Phonebook		Extended 2
	New Phonebook		Russian
	Search		Select
	Key Lock		Pause
	12/24 Hour Clock		Mute
	Stop		Delete
	No Function		

◆◆ Icons above the Base Unit Soft Keys

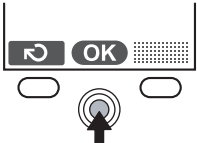
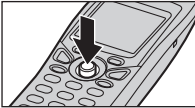
Icons	Functions	Icons	Functions
	Go Back		Pause
	Menu		Intercom/Paging
	OK		Caller ID List
	Phonebook		Repeat Message
	No Function		Skip Message
	Delete		

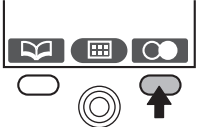

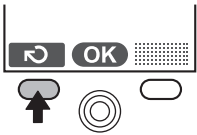



Symbols Used for Operations

◆◆ Symbols Used for Cordless Handset Operations

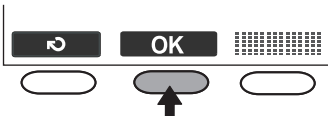

Symbol	Meaning	
	<p>Move the JOYSTICK up, down, left or right. e.g., Search for the main menu.</p> 	
<p>e.g., OK</p> 	<p>e.g., Display of menu items</p> 	<p>Press JOYSTICK directly in the centre.</p> <p>In this example, the desired item is selected.</p> <p>Press Directly</p> 
<p>e.g., Redial</p> 	<p>e.g., Standby Mode Display</p> 	<p>Press RIGHT SOFT KEY.</p> <p>In this example, the telephone number last dialled is displayed.</p>
<p>e.g., Go Back</p> 	<p>e.g., Display of menu items</p> 	<p>Press LEFT SOFT KEY.</p> <p>In this example, the display returns to the previous menu.</p> <p> has the same function as go back.</p>
	<p>Press POWER/TALK OFF Button.</p> <p><u>Press this button at any time to return the display to the standby display mode.</u></p>	

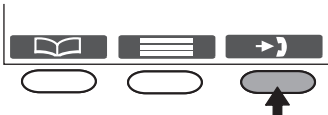
Symbols Used for Operations

◆◆ Symbols Used for Base Unit Operations

Symbol	Meaning	
	Press NAVIGATOR KEY up or down. e.g., Search for the desired item.	
e.g., OK 	e.g., Display of menu items 	Press MIDDLE SOFT KEY . In this example, the desired item is selected.
e.g., Caller ID List 	e.g., Standby Mode Display 	Press RIGHT SOFT KEY . In this example, the newest caller information is displayed.
e.g., Go Back 	e.g., Display of menu items 	Press LEFT SOFT KEY . In this example, the display returns to the previous menu.

◆◆ Symbols Used for Cordless Handset/Base Unit Operations

Symbol	Meaning
	Go to the next step.
“ ”	The words in “ ” indicate the text shown on the display.
	The phone is ringing.

◆◆ Handset Display Icons

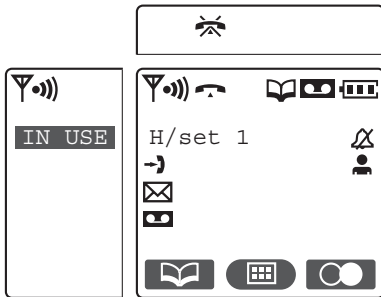

Phonebook Mode



Answering System ON
Message indication



Battery strength



Direct Call ON



Ringer Volume OFF



Within range of a base unit



Out of range/No registration/
No power on base unit



Intercom/Paging/
While connecting with base unit



Making or answering calls



Call Bar ON



New call (Caller ID only)

H/set 1

Cordless Handset Name (e.g., Cordless Handset 1)



SMS mail (text messages) indication



IN USE

The line is being used by another unit.



Voice Tag indication

◆ Main Menu Display

To go to the **Main Menu**, press **JOYSTICK**  directly in the centre (or move ) while in the standby mode display. The selected menu icon is turned over, and its title is displayed.

Example: “Caller ID” is selected.

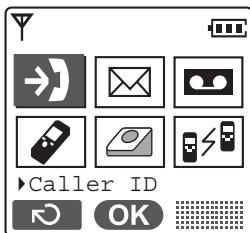

“Caller ID”



“SMS”



“TAM Operation”



“Setting Handset”



“Setting Base”



“Walkie-Talkie”

Display

◆◆ Base Unit Display Icons

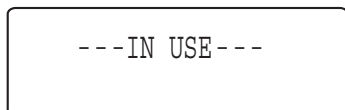

Intercom/Paging



Making or Answering calls



Call Bar ON



Phonebook Mode



Ringer Volume OFF



New call (Caller ID only)

---IN USE---

The line is being used by another unit.



H/set 1

Intercom Mode

Cordless Handset Name (e.g.,
Cordless Handset 1)



Message indication

◆◆ Connection

The telephone will not work during a power failure. We therefore recommend you use a standard telephone and T adaptor to connect this Digital Cordless Phone to the line. Your Panasonic Sales Shop can offer you more information about connection possibilities.

(For Base Unit)

Plug in the AC adaptor and the telephone line cord in order **1, 2, 3, 4**.

The cords can be hidden from view when using the base unit on a desktop by tucking them under the wall mounting adaptor (p.115, 116).

Hook

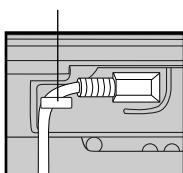

Fasten the AC adaptor cord to prevent it from being disconnected.

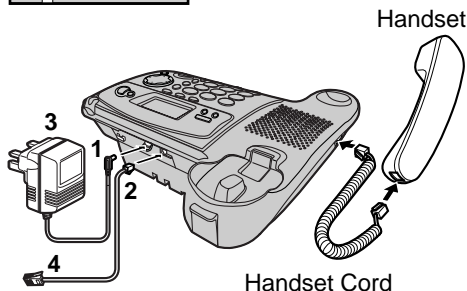

- The AC adaptor must remain connected at all times (It is normal for the adaptor to feel warm during use).
- Never install telephone wiring during a lightning storm.
- USE ONLY WITH Panasonic AC ADAPTOR PQLV19E (Order No. PQLV19EZ).

(For Charger Unit)

The batteries must be fully charged before initial use of the cordless handset.

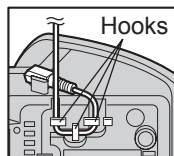

Fasten the AC adaptor cord to prevent it from being disconnected.

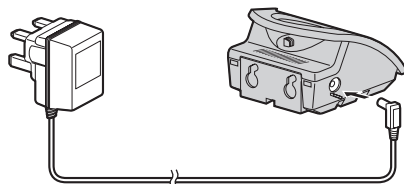

- The AC adaptor must remain connected at all times (It is normal for the adaptor to feel warm during use).
- USE ONLY WITH Panasonic AC ADAPTOR PQLV200E (Order No. PQLV200EZ).

◆◆ Battery Installation

Please ensure the batteries are inserted as shown. ⊖ part should be inserted first. Close the cover as indicated by the arrow.

- When you replace the batteries, ⊕ part should be removed first.

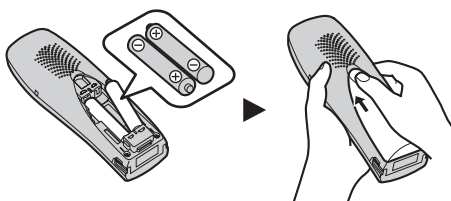

Setting up

◆◆ Battery Charge

At the time of shipment, the batteries are not charged. To charge, place the cordless handset on the charger. **Please charge the batteries for about 7 hours before initial use.**



During charging, the charge LED will light as shown below.

During charging

Fully charged

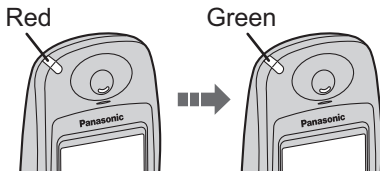

Display icon	Battery strength
	High
	Medium
	Low
	Needs to be charged

The cordless handset, even when switched off, will be turned on automatically when it is placed on the charger.

The cordless handset will not operate while it is on the charger.

If the handset display flashes when the cordless handset is lifted off the charger, please charge the cordless

handset batteries at least 15 minutes.

◆◆ Battery Information

After your Panasonic batteries are fully charged:

Ni-MH Batteries (typical 700 mAh)

Operation	Operating Time
While in use (TALK)	10 hrs approx.
While not in use (Standby)	180 hrs approx.

Ni-Cd Batteries (typical 250 mAh)

Operation	Operating Time
While in use (TALK)	4 hrs approx.
While not in use (Standby)	60 hrs approx.

- Times indicated are for peak performance.
- The battery operating time may be shortened depending on usage conditions and ambient temperature.
- **Clean the charge contacts of the cordless handset and the charger with a soft, dry cloth once a month. Clean more often if the unit is subject to grease, dust or high humidity.** Otherwise the battery may not charge properly.
- The batteries cannot be overcharged unless they are repeatedly removed and replaced.
- For maximum battery life, it is recommended that the cordless handset not be recharged until the battery icon flashes .

◆◆ Replacing the Batteries

If the  icon flashes after a few telephone calls even when the cordless handset batteries have been fully charged, both batteries must be replaced.

- **Charge new batteries for approximately 7 hours before initial use.**
- **When replacing the batteries, be sure to set up the battery type even if you install the same type of batteries to initialise battery remaining memory of your cordless handset. (See Setting the Battery Type on page 75.)**
- **Do not use non-rechargeable batteries. If non-rechargeable batteries are installed and start charging, battery electrolyte may leak from the unit.**
- **Open the battery cover by pressing down firmly on the notch and sliding it as indicated by the arrow below.**



Replace both batteries (p.15) and close the cover. Charge the cordless handset for about 7 hours.

Please order Panasonic P03P (Ni-MH) or P03H (Ni-Cd) batteries.

Setting up

◆◆ Power ON/OFF

◆ Power ON

Press and hold **POWER**.



When **POWER** is released, the display changes to the standby mode.

◆ Power OFF

Press and hold **POWER**.



The display goes blank.











◆◆ Selecting the Display Language

You can select one of 19 languages on the cordless handset and the base unit separately. The factory preset is English.











◆ Selecting the Display Language on the Cordless Handset

To exit the operation, press  at any time.

1 Press JOYSTICK (or move). 	2 Select "  Setting Handset".  → 	3 Select "Display Option".  → 
4 Select "Select Language".  → 	5 Select the desired language.  → 	

- If you set a language you cannot read, reset the display language to your desired language.

Press  → Press  → Move  → Press  → Move  four times → Press  → Move  twice → Press  → Select the desired language → Press .







◆ Selecting the Display Language on the Base Unit

To exit the operation, press  at any time.

<p>1 Press MIDDLE SOFT KEY.</p> 	<p>2 Select "Select Language".</p>  → 	<p>3 Select the desired language.</p>  → 
---	---	---

- If you set a language you cannot read, reset the display language to your desired language.









Press  → Press  (DOWN) 3 times → Press  → Select the desired language → Press .

Setting up













◆◆ Setting the Date and Time

After a mains power failure, the clock needs to be set. Ensure that the  icon is not flashing. After the date and time are set, the base unit display also shows the date and time. This feature can be operated with the cordless handset only.

To exit the operation, press  at any time.



<p>1 Press JOYSTICK (or move).</p> 	<p>2 Select “ Setting Handset”.</p>  → 	<p>3 Select “Set Date/ Time”.</p>  → 
<p>4 Enter the date (see below).</p>	<p>5 Enter the time (see below).</p>	<p>6 Press JOYSTICK.</p>  

Example: To set 16 February, 2003, 7:15 pm.

Date			Time		
Day	Month	Year	Hour	Minute	12/24 hour clock
 	→  	→  	→  	→  	→  

◆ Selecting 12/24 Hour Clock

Press **RIGHT SOFT KEY** repeatedly.

 	<p>24 hour clock</p>	<p>→ 12 hour clock (AM)</p>	<p>→ 12 hour clock (PM)</p>
---	----------------------	-----------------------------	-----------------------------



◆◆ Making a Call



◆ Pre-Dialling



- 1 Enter Phone Number.
- 2 Press **TALK**.



◆ Post-Dialling

- 1 Press **TALK**.
- 2 Enter Phone Number.



- If you need to make a correction while entering the phone number when using **Pre-Dialling**, press . The digit is cleared to the left, then you can enter new digits. All digits are cleared if you press and hold .
- You can also press  to make a call.





◆ Pre-Dialling

- 1 Enter Phone Number.
- 2 Lift the handset.

◆ Post-Dialling

- 1 Lift the handset.
- 2 Enter Phone Number.

- If you need to make a correction while entering the phone number when using **Pre-Dialling**, press . The digit is cleared to the left, then you can enter new digits. All digits are cleared if you press and hold .
- You can also press  to make a call.

Using the Telephone

◆◆ Answering a Call





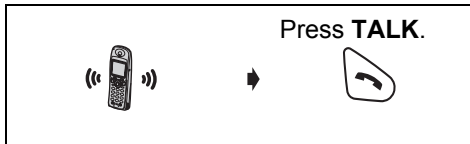

◆ Answering a Call

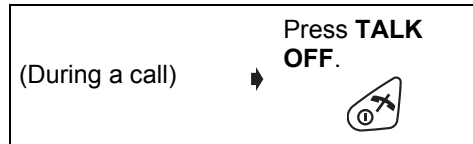

◆ Terminating a Call



- You can also answer a call by pressing  to , , ,  or  (**Any Key Talk**).



◆ Answering a Call

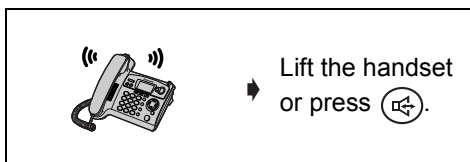

◆ Terminating a Call

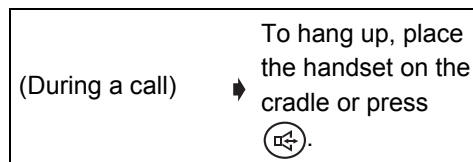

- You can also answer a call by pressing .

◆◆ Auto Talk

If you set **Auto Talk** to ON, you can answer a call by lifting the cordless handset off the charger. (See **Setting Auto Talk ON/OFF** on page 75.)

◆◆ Receiver (or Headset Receiver)/Speaker Volume



The choices for the receiver (or headset receiver) volume are 3 levels, and 6 levels for the speakerphone volume.

(During a call) ➔

To increase volume, move the **JOYSTICK** up.
To decrease volume, move the **JOYSTICK** down.



- The factory preset is medium (receiver volume) and level 3 (speaker volume).



The choices for the handset receiver volume are 3 levels, and 8 levels for the speakerphone volume.

(During a call) ➔

To increase volume, press **NAVIGATOR KEY** up.
To decrease volume, press **NAVIGATOR KEY** down.



- The factory preset is medium (receiver volume) and level 5 (speaker volume).

◆◆ Have a Hands-Free Phone Conversation (using Digital Speakerphone)



Speakerphone allows you to talk to your caller without holding the cordless handset and allows other persons in the room to listen to the conversation.

◆ Returning to Receiver

(During a call) ➔

Press **SPEAKERPHONE**.



Press **TALK**.



- For best performance, please note the following:
 - Talk alternately with the caller in a quiet environment.
 - If either party has difficulty hearing, move the **JOYSTICK** up or down for the cordless handset to change the volume accordingly. The choices for the speakerphone volume are 6 levels.

Using the Telephone



Speakerphone allows you to talk to your caller without holding the handset and allows other persons in the room to listen to the conversation.

Press **SPEAKERPHONE**.

(Receiving a call) →



- For best performance, please note the following:
 - Talk alternately with the caller in a quiet environment.
 - If either party has difficulty hearing, press **NAVIGATOR KEY** up or down to change the volume accordingly. The choices for the speakerphone volume are 8 levels for the base unit.

◆◆ Muting Your Conversation

During a call, you can mute your phone so the other party cannot hear you, but you can hear them.



◆ Muting

(During a call) →

Press **LEFT SOFT KEY**, then Icon flashes.



◆ Returning to the Conversation

Press **LEFT SOFT KEY** once again. Icon stops flashing.



◆ Muting

(During a call) →

Press **MUTE**.





◆ Returning to the Conversation

Press **MUTE** once again.



◆◆ Key Lock

You lock the cordless handset dialling buttons. While locked, the buttons cannot be used and therefore calls cannot be made. Incoming calls can be answered while the key lock is ON. When the key lock is ON, the menu icon  changes to .

When the key lock is ON, emergency calls (p.78) cannot be made until key lock is cancelled.

◆ Key Lock ON

(Standby Mode Display) → Press and hold **JOYSTICK** directly for more than 2 seconds.



The diagram shows a horizontal line. Above the line is the menu icon (a grid of squares). Below the line is the key lock icon (a key symbol). Below the key lock icon is a joystick button, which is a circle with concentric rings.

◆ Key Lock OFF

Press and hold **JOYSTICK** directly for more than 2 seconds once again.



Using the Telephone

◆◆ Redialling

The last 10 numbers dialled on the cordless handset and the base unit are automatically stored in the redial list separately.



◆ Dialling with the Redial List

1 Press **RIGHT SOFT KEY**.





2 Search for the desired dialled item.



3 Press **TALK**.



- If there are no items stored in the redial list when  is pressed, the handset display shows "Memory Empty".
- When scrolling reaches the end of the list, an end tone will sound.
- You can also press  to make a call.
- To save the numbers from the redial list into the handset phonebook, or to edit or delete from memory, see pages 34 and 35.

◆ Dialling the Last Number Dialed





1 Press **TALK**.



2 Press **RIGHT SOFT KEY**.



Auto Redial

If you press  then  and the number is engaged, the unit will automatically redial the number every 40 seconds, up to 12 times. When using Auto Redial, press  after pressing  if the muting has not been cancelled.



◆ Dialling with the Redial List



1 Press **REDIAL**.



2 Search for the desired dialled item.



3 Lift the handset.

- If there is no item stored in the redial list when  is pressed, the base unit display shows “Memory Empty”.
- When scrolling reaches the end of the list, an end tone will sound.
- You can also press  to make a call.
- To edit or delete from memory, see page 84.





◆ Dialling the Last Number Dialed

1 Lift the handset.





2 Press **REDIAL**.



Auto Redial

If you press  then  and the number is engaged, the unit will automatically redial the number every 40 seconds, up to 12 times. When using Auto Redial, press  after pressing  if the muting has not been cancelled.

◆◆ Recall Feature

RECALL  (on the cordless handset) or  (on the base unit) is used to access special telephone services. Contact your network provider for details. If your unit is connected to a PBX, pressing  (on the cordless handset) or  (on the base unit) allows you to access certain features of your host PBX, such as transferring an extension call.

Using the Telephone

◆◆ Dialling Pause (for PBX line/long distance service users)



A dialling pause can be entered when a pause in the dialling of a phone number is necessary when using a PBX or accessing a long distance service.



For example, if using the unit with a PBX and a line access number (9, in this example must be dialled before the telephone number:



1 Press 9 .	2 Press RIGHT SOFT KEY .	3 Enter Phone Number.	4 Press TALK .
			



1 Press 9 .	2 Press RIGHT SOFT KEY .	3 Enter Phone Number.	4 Lift the handset.
			

- You can also press  (for cordless handset) or  (for base unit) to make a call.
- Entering a pause can prevent misdialling when you redial or dial a stored number.
- Pressing **RIGHT SOFT KEY** more than once increases the length of the pause between numbers.
- To change the pause time, see page 78.

◆◆ Call Waiting

Call Waiting is a service of your network provider and will operate only if you have subscribed to this service. If you subscribe to Call Waiting, a tone will notify you when another person calls you while you are already talking on the phone. You can answer the second call, keeping the first call on hold.



(Call waiting tone sounds during a call) → Press **RECALL.**  → The first call is put on hold and the second call is answered.

◆ Returning to the First Caller

Press **RECALL** once again.



(Call waiting tone sounds during a call) → Press **RECALL.**  → The first call is put on hold and the second call is answered.

◆ Returning to the First Caller

Press **RECALL** once again.



- If you subscribe to both Caller ID and Call Waiting, the units will display the second caller's phone number when you hear the call waiting tone. If the phone number of the second caller is stored in the unit's phonebook along with a name, the caller's name will be displayed.
- If the phone number is stored in the base unit phonebook with its name, the caller's name will also be displayed.
- Please consult your Network provider for details of this service.

Caller ID

◆◆ Caller ID Service

Caller ID is a service of your Network provider and will operate only if you have subscribed to this service.

After subscribing to Caller ID, this phone can display the phone number of the caller when you receive a call. If the telephone number received by Caller ID is stored in the unit's phonebook along with a name, the caller's name will be displayed.

The last 50 callers' phone numbers are stored in the order the calls were received. When the 51st call is received, the oldest caller information is cleared. If the caller's name has been stored with the number in the phonebook (see **Storing Caller Information** in the phonebook on page 37, 38), the caller's name will also be displayed.

If your unit is connected to a PBX or a telephone line that does not support this service, you will not be able to use it.

When new calls have been received, the display shows the number of calls.

In the example below, 10 new calls have been received.

Please see Caller ID List (p.82) for base unit operation.



◆ Standby Mode Display

```
H/set 1
-> 10 Calls
17.8 14:59
```



◆ Standby Mode Display

```
-> 10 Calls
17.8 14:59
```



◆◆ Making a Call from the Caller ID List

To exit the operation, press  at any time.

1 Press **JOYSTICK** (or move).



2 Select "**→** Caller ID".

 → 

3 The newest caller information is displayed.

Time Received _____

Date Received—17.8 14:59

Name—JOHN SMITH

Tel No.—0123456789

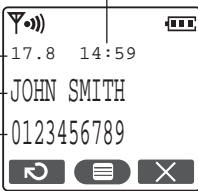

4 Search for the desired item.



5 Press **TALK**.











- You can also press  to make a call.
- “√” indicates you have already viewed this caller information, or answered the call. It also indicates the other registered unit user has already viewed this caller information, or answered the call.
- If the caller has requested not to display his/her information, the display shows “Private Caller”.
- If the caller dialed from an area which does not provide Caller ID service, the display shows “Out of Area”.
- When scrolling reaches the end of the list, an end tone will sound.

List Menu

◆◆ Caller ID List Menu

You can save the numbers from the Caller ID list into the handset phonebook, and you can edit (for calling) or delete item(s) in the Caller ID List.













To exit the operation, press  at any time.

1 Press JOYSTICK (or move). 	2 Select "  Caller ID".  →  	3 Select the desired item.  →  
Go to step 4.		

- When scrolling reaches the end of the list, an end tone will sound.
- If there are no items stored in the caller list when "Caller ID" is selected, the handset display shows "Memory Empty".

◆ Storing a Number in the Handset Phonebook

Follow steps 1 to 3 shown above, then:

4 Select "Save Phonebook".  →  	5 Enter Name (p.39, 40), then press   (max. 16 characters) If required, edit phone number. (max. 24 digits)	6 Press JOYSTICK .  
7 Select the desired category or "Off" (p.36).  →  	8 Select "Save", then "Saved" is displayed.  	

◆ Editing the Received Number for Calling

Follow steps 1 to 3 on the previous page, then:

4 Select “Edit for Call”.



5 Edit Phone Number.
(max. 24 digits)

6 Press **TALK** or press **JOYSTICK** to call.

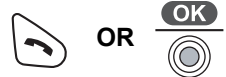

- You can also press  to make a call.

◆ Deleting One/All Caller ID Item(s)

Follow steps 1 to 3 on the previous page, then:

4 Select “Delete” or “Delete All”.



5 Select “Yes”, then “Deleted” is displayed.







List Menu

◆◆ Redial List Menu







You can save numbers from the redial list into the handset phonebook, and you can edit (for calling) or delete item(s) in the redial list.

To exit the operation, press  at any time.

1 Press RIGHT SOFT KEY . 	2 Select the desired item.  → 
Go to step 3.	

- If there are no items stored in the redial list when  is pressed, the handset display shows "Memory Empty".

◆ Storing the Number in the Handset Phonebook

Follow steps 1 and 2 shown above, then:		
3 Select "Save Phonebook".  → 	4 Enter Name (p.39, 40). (max. 16 characters)	5 Press JOYSTICK twice.  twice
6 Select the desired category or "Off" (p.36).  → 	7 Select "Save", then "Saved" is displayed. 	

◆ Editing the Dialed Number for Calling

Follow steps **1** and **2** on the previous page, then:

3 Select “Edit for Call”.



4 Edit Phone Number.
(max. 24 digits)

5 Press **TALK** or press **JOYSTICK** to call.



- You can also press  to make a call.

◆ Deleting One/All Redial Item(s)

Follow steps **1** and **2** on the previous page, then:

3 Select “Delete” or “Delete All”.



4 Select “Yes”, then “Deleted” is displayed.



Using the Phonebook

You can store up to 200 caller information in the handset phonebook and up to 20 caller information in the base unit phonebook. If you subscribed to Caller ID and you received a call from the same phone number you stored with name in each phonebook, the display will show the caller's name.

When same phone number has been registered to the handset and the base unit phonebook with different names, each display will show each registered caller's name.

◆◆ Private Category Feature

You can categorise caller information in the handset phonebook. There are 9 categories available. For example, category 1 can be used to save all friends numbers. For each category, you can rewrite the category names (max. 10 characters: see **Changing the Category Name** on page 71), you can select one of 3 Ringer LED colours (see **Setting the Private Colour** on page 71) and one of 15 ringer types (see **Ringer Options** on page 68).

This feature is available only after subscription to Caller ID Service. Please contact your network provider for further information.

Example

Private Category No.	Ringer LED Colour*			Private Ringer Type	Category Name
	Green	Orange	Red		
1		✓		3	Friends
3			✓	2	Customers

* The factory preset LED colour is green.

- The unit will indicate an incoming call using the factory preset LED colour (green) and the ringer pattern assigned to external calls (p.69) momentarily until Caller ID information is received from the network provider.

◆◆ Audible Caller ID









To use this feature, you need to subscribe to Caller ID service. For further information, please contact your network provider. You need to store caller information and to record the name into the base unit phonebook (p.38).

When a call comes in, the unit will ring and the caller information will be received. If you receive a call from one of the same phone numbers stored in the base unit phonebook, the recorded name will be announced.

- If the ringer volume of the cordless handset is OFF, recorded names will not be announced. Announcement volume depends on the cordless handset ringer setting (p.69).
- If the ringer volume of the base unit is OFF, recorded names will not be announced. Announcement volume depends on the base unit ringer setting (p.86).
- Your unit may mute one or more of rings in order to announce the name of the caller, as announcement is prior to rings.

◆◆ Storing Caller Information in the Handset Phonebook

To exit the operation, press  at any time.

1 Press LEFT SOFT KEY . 	2 Press JOYSTICK . 	3 Select "H/set Phonebook", then the display shows the number of empty phonebook entries.  → 
4 Enter Name (p. 39). (max. 16 characters)	5 Press JOYSTICK . 	6 Enter Phone Number. (max. 24 digits)
7 Press JOYSTICK . 	8 Select the desired category or "Off".  → 	9 Select "Save", then "Saved" is displayed. 

- If "Memory Full" is displayed in step 3, the phonebook is full. To store, delete other stored items in the phonebook.
- To continue storing other caller information, repeat from step 4.
- If you need to go back to entering name during entering phone number, move the **JOYSTICK** up.











Using the Phonebook

◆◆ Storing Caller Information in Base Unit Phonebook

This feature can be operated with the cordless handset only.





To use an Audible Caller ID feature (p.36), you must store caller information into the base unit phonebook.

To exit the operation, press  at any time.

1 Press LEFT SOFT KEY . 	2 Press JOYSTICK . 	3 Select "Base Phonebook", then the display shows the number of empty phonebook entries.  → 
4 Enter Name (p.39). (max. 16 characters)	5 Press JOYSTICK . 	6 Enter Phone Number. (max. 24 digits)
7 Press JOYSTICK . 	8 Select "Start Recording".  → 	9 Record the name within 1 minute.
10 Press JOYSTICK . 	11 Select "Save", then "Saved" is displayed. 	

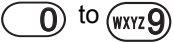
- If "Memory Full" is displayed in step **3**, the phonebook is full. To store, delete other stored items in the phonebook.
- If "Memory Full" is displayed in step **8**, the remaining recording time is **0**. To store, delete unnecessary incoming/memo messages (p.105, 107).
- To continue storing other caller information, repeat from step **4**.
- If you do not use Audible Caller ID feature, select "Skip Recording" at step **8** and go to step **11**.
- If you need to go back to entering name during entering phone number, move the **JOYSTICK** up.

◆◆ Entering Names/Characters

Keys	Operations
	Move the JOYSTICK up, down, left or right to move the cursor.
	Press to enter letters/numbers. (Items are added to the left of the cursor. If the cursor is at the beginning of a line, the item is added at the beginning.)
	Press to delete characters. (Character on the cursor is deleted. To delete all characters, press and hold.)
	Press to change between upper and lower case.
	Press to insert a blank space (except when in Numeric input mode).
	Press to insert a symbol (* , # , / , etc.) (except when in Numeric input mode).

Using the Phonebook

◆ Selecting the Input Mode

You can select one of 7 input modes by pressing **RIGHT SOFT KEY** while entering a name. The function icon above the key displays the current input mode. The factory preset is “**LetterWise®**”. **LetterWise®** is a simplified text entry system. This system suggests to the user the most likely letter to follow the text entered previously. To enter texts in this mode, see page 56.

For the full character map, see **Phonebook Character Table** (p.124).

To switch the input mode while editing the name in the phonebook, press **RIGHT SOFT KEY**.

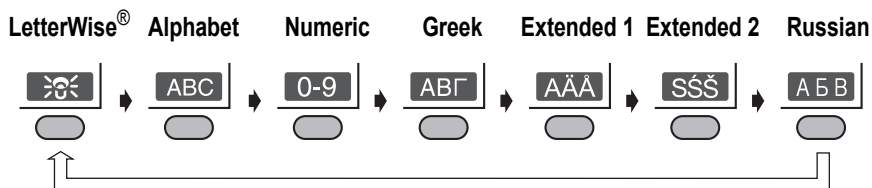

- If **LetterWise®** is selected, select a language you require (p.75).

Example (Alphabet Mode)

Enter the name using the letters on the keypad. For example, to enter “Anne” in Alphabet Mode:



◆◆ Finding Items in the Handset/Base Unit Phonebook



All phonebook items are stored in the following order: Alphabet letter/Symbol/Number/Telephone Number (when a name is not stored).

To exit the operation, press at any time.

(For Handset Phonebook)

- If voice tag is recorded, will appear on the display of the handset phonebook item.

1 Press **LEFT SOFT KEY**.



2 Move the **JOYSTICK** up or down to search for the desired item.



(For Base Unit Phonebook)

Please see page 85 for the operation performed with the base unit.

1 Press **LEFT SOFT KEY** twice.



twice

2 Move the **JOYSTICK** up or down to search for the desired item.



◆ Searching for a Name by Initial

Example: To find "Felix"

(For Handset Phonebook)

1 Press **LEFT SOFT KEY**.



OR

(For Base Unit Phonebook)

1 Press **LEFT SOFT KEY** twice.



twice

2 Press **3** repeatedly until the first item under "F" is displayed.



3 Move the **JOYSTICK** down until "Felix" is displayed.









Using the Phonebook

◆ Searching by Private Category (For Handset Phonebook)





1 Press LEFT SOFT KEY .	2 Press RIGHT SOFT KEY .	3 Select "Category".
		
4 Select the desired category.	5 Select the desired item to display.	
		

◆ Searching by Index Search Mode

Example: To find "ΣΟΦΙΑ" (SOPHIA).
(For Handset Phonebook)

1 Press LEFT SOFT KEY .	2 Press RIGHT SOFT KEY .	3 Select "Index Search".
		
4 Press RIGHT SOFT KEY repeatedly until the desired input mode (Greek) appears.	5 Select the desired initial character "Σ".	6 Move the JOYSTICK down until "ΣΟΦΙΑ" is displayed.
		

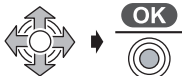



(For Base Unit Phonebook)

1 Press LEFT SOFT KEY twice.	2 Press RIGHT SOFT KEY .	3 Press RIGHT SOFT KEY repeatedly until the desired input mode (Greek) appears.
 twice		
4 Select the desired initial character "Σ".	5 Move the JOYSTICK down until "ΣΟΦΙΑ" is displayed.	
		

Using the Phonebook



◆ Searching an Item in the Voice Tag List

Please see **Voice Search for the Handset Phonebook** for recording voice tag. (p.48)

1 Press LEFT SOFT KEY . 	2 Press RIGHT SOFT KEY . 	3 Select "Voice Tag". 
4 Select the desired item to display. 		



◆◆ Dialling from the Handset/Base Unit Phonebook

(For Handset Phonebook)

1 Press LEFT SOFT KEY . 	2 Select the desired item (see page 41 and 42).	3 Press TALK or SPEAKERPHONE .  OR 
--	--	---

(For Base Unit Phonebook)

Please see page 85 for the operation performed with the base unit.

1 Press LEFT SOFT KEY twice.  twice	2 Select the desired item (see page 41 and 42).	3 Press TALK or SPEAKERPHONE .  OR 
---	--	---











Using the Phonebook

◆◆ Editing Caller Information in the Handset/Base Unit Phonebook

This feature can be operated with the cordless handset only.









To exit the operation, press  at any time.

(For Handset Phonebook)

1 Press LEFT SOFT KEY . 	2 Select the desired item.  → 	3 Select "Edit".  → 
4 Edit Name. (max. 16 characters)	5 Press JOYSTICK . 	6 Edit Phone Number. (max. 24 digits)
7 Press JOYSTICK . 	8 Select the desired category or "Off".  → 	9 Select "Save", then "Saved" is displayed. 

- To continue editing other caller information, repeat from step 2.

(For Base Unit Phonebook)

<p>1 Press LEFT SOFT KEY twice.</p>  twice	<p>2 Select the desired item.</p> 	<p>3 Select "Edit".</p> 
<p>4 Edit Name. (max. 16 characters)</p>	<p>5 Press JOYSTICK.</p> 	<p>6 Edit Phone Number. (max. 24 digits)</p>
<p>7 Press JOYSTICK.</p> 	<p>8 Select "Start Recording". If you do not change the recorded name, select "Skip Recording", then go to step 11. If you delete the recorded name, select "Delete", then go to step 11.</p> 	
<p>9 Record the name within 1 minute.</p>	<p>10 Press JOYSTICK.</p> 	<p>11 Select "Save". then "Saved" is displayed.</p> 





- To continue editing other caller information, repeat from step 2.
- If you confirm the recorded name, select "Audible Call", then press  at step 3.

◆◆ Deleting Caller Information in the Handset/Base Unit Phonebook

This feature can be operated with the cordless handset only.







To exit the operation, press  at any time.

(For Handset Phonebook)

<p>1 Press LEFT SOFT KEY.</p> 	<p>2 Select the desired item.</p> 	<p>3 Select "Delete".</p> 
<p>4 Select "Yes", then "Deleted" is displayed.</p> 		

Using the Phonebook

(For Base Unit Phonebook)

1 Press LEFT SOFT KEY twice.  twice	2 Select the desired item.  → 	3 Select "Delete".  → 
4 Select "Yes", then "Deleted" is displayed.  → 		









- To continue deleting other caller information, repeat from step 2.
- If there are no items stored in the handset/base unit phonebook when selecting the desired item, the display shows "Memory Empty".

◆◆ Hot Keys

You can assign 9 hot keys. You can choose 9 phone numbers from the handset phonebook.

To exit the operation, press  at any time.

◆ Registering a Phone Number as a Hot Key

1 Press LEFT SOFT KEY .	2 Select the desired item.	3 Select "Reg. to Hot Key".
	 → 	 → 
4 Select the desired dialling button number.  → 	5 Select "Save", then "Saved" is displayed. 	

- If there are no items stored in the handset phonebook when searching for the desired item, the handset display shows "Memory Empty".
- If an item is already stored to a hot key, "✓" will be displayed on the left of the key number. If a hot key number with "✓" is selected, press  to select "Overwrite".

◆ Dialling with a Hot Key

1 Press and hold the dialling button registered as a hot key until a phone number is displayed.

2 Press **TALK** or **SPEAKERPHONE**.

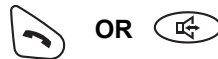

◆ Deleting the Hot Key Registration

1 Press and hold the dialling button registered as a hot key until a phone number is displayed.

2 Press **JOYSTICK**.

3 Select "Delete".



4 Select "Yes", then "Deleted" is displayed.



- Handset phonebook registration will not be erased when hot key registration is deleted.

◆◆ Chain Dial

For example, when you use PIN code or Password according to guidance of bank service or another, this function is useful.

(During a call)



1 Press **JOYSTICK**.

2 Press **RIGHT SOFT KEY**.



3 Move the **JOYSTICK** up or down to search for the desired item.

4 Select the desired item.



→ Dialling

- To continue entering code, repeat from step 1.
- To search for the desired item by **Name by Initial**, **Private Category**, **Index**, **Voice Tag List** at step 3, please refer to page 41 - 43.
- Searching for the desired item with Voice Search is not available.

Voice Search for the Handset Phonebook

◆◆ Voice Search







You can record up to 20 voice tags for the handset phonebook items, then you can search an item in the handset phonebook with your voice. If you set the Auto Voice Dial ON (p.75), the selected item with your voice is automatically dialled out.



Ensure that the  icon is not flashing.

To exit the operation, press  at any time.

◆ Recording Voice Tag for Voice Search

You must record voice tag 2 times.

1 Press LEFT SOFT KEY . 	2 Select the desired item.  → 	3 Select "Voice Tag".  → 
4 Select "Record".  →  (Beep)		
5 Start recording <ul style="list-style-type: none">Record voice tag within 2 seconds after "Voice Tag Record" is displayed.20 cm away from the Mic.Speak clearly in the quiet room.	(Beep) →	Repeat recording <ul style="list-style-type: none">Record voice tag again for confirmation.If voice tag recording is completed, "Saved" will appear on the display.

-  button lights after step 4.
- Please try recording a different voice tag if similar voice tag is already recorded.
- "Timeout Please Try Again" is displayed if recording time is over 10 seconds.
- "Too Long Please Try Again" is displayed if voice tag is recorded more than 2 seconds.
- "Too Different Please Try Again" is displayed if the 2nd voice tag was recorded too different from the 1st one.
- "Already Exists Please Try Again" is displayed after the 2nd recording if similar voice tag exists already.
- If key Tone is OFF (p.70), a beep will not sound.
- Voice Search performs the best when used by the same person who recorded the voice tag. If a different person tries to perform a voice search, this feature may not function properly.
- If voice tag is recorded,   will appear on the display of the handset phonebook item.



Voice Search for the Handset Phonebook

◆ Searching with Your Voice

1 Press and hold **LEFT SOFT KEY**.



2 Speak a name of item in the Voice Tag List.

- If there are no voice tags stored in the handset phonebook when  is pressed and held, "Voice Tag Memory Empty" is displayed.
- If the matched voice tag is found, the recorded voice tag is played and the item in the handset phonebook with the voice tag is displayed, then you can make a call if you press . If Auto Voice Dial is On (p.75), it is automatically dialled out.
- "No Match Please Try Again" is displayed if there are no matched voice tag, then the unit will retry up to 5 times automatically.
- "Timeout Please Try Again" is displayed if searching time is over 10 seconds.
- Voice Search performs the best when used by the same person who recorded the voice tag. If a different person tries to perform a voice search, this feature may not function properly.
- **If a desired voice tag is often not found, delete the voice tag and try recording a different voice tag.**

◆ Playing a Voice Tag

1 Press **LEFT SOFT KEY**.



2 Select the desired item.



3 Select "Voice Tag".



4 Select "Play".



-  button lights after step 4.

◆ Deleting a Voice Tag

1 Press **LEFT SOFT KEY**.



2 Select the desired item.



3 Select "Voice Tag".



4 Select "Delete".



5 Select "Yes".

















Phonebook Copy

◆◆ Phonebook Copy

You can copy handset phonebook information between cordless handsets registered to the same base unit. The handset phonebook copy must be performed while in intercom mode (see **Intercom Between Registered Units** on page 92).

To exit the operation, press  at any time.





◆ Example: Copying a Handset Phonebook Item to Another Handset Phonebook

	<Cordless Handset 1: Receiver>	<Cordless Handset 2: Sender>
1	Press INTERCOM  , then press the desired cordless handset number  .	 («  »)
2		Press TALK  .
	(During an intercom call)	
3	Press JOYSTICK . 	
4	Select "Recv Phonebook". "Start Copying" is displayed.  → 	
5		Press JOYSTICK . 
6		Select "Send Phonebook".  → 
7		Select the desired item to copy.  → 
8		Select "Copy One Item" then "Start Copying" is displayed.  → 

◆ Example: Copying All Handset Phonebook Items to Another Handset Phonebook









To exit the operation, press  at any time.

Follow steps 1 to 6 on the previous page, then:

7	<Cordless Handset 1: Receiver>	<Cordless Handset 2: Sender>
8		<p>Press JOYSTICK.</p> <p style="text-align: center;"> </p> <p>Select "Copy All Items" then "Start Copying" is displayed.</p> <p style="text-align: center;"> →  </p>

- When copying is completed, a beep sounds and "Copy Complete" is displayed. After a few seconds, the handset display will return to the intercom call. "Copy Incomplete" will be displayed on the sender handset if the receiver handset memory is full. If "Copy Failure" is displayed on the sender handset, the receiver did not prepare for copying.
- If you move the **JOYSTICK** up or down before pressing **JOYSTICK** on step 7, all items will not be copied. The items, from the item indicated now to the last item, are copied.

◆ Example: Copying a Handset Phonebook Item to the Base Unit Phonebook

1 Press INTERCOM .	2 Press JOYSTICK .	3 Select "Copy to Base".
	 	 
4 Select the desired item.		
 →  		

- If "Memory Full" is displayed when you select "Copy to Base", the base unit phonebook is full.
- Items in the handset phonebook can be copied one at a time.

SMS Feature (Text Message)

You can send and receive text messages between other fixed and mobile phones that also support a compatible SMS feature and network.

The SMS feature is available only after subscribing to Caller ID.

Before sending your first text message, or to find out more information on SMS conditions and registration, please read your SMS Conditions (Text Messaging) for Bizzyline (Direct) Ltd. If you have any questions relating to the SMS Service Help, please call 09063020069. Calls are charged at 50p per minute. The helpdesk is open from 9.00am-5.30pm (Mon-Fri). The SMS Network Provider described in these Operating Instructions is not available within the Republic of Ireland.
For further information, please contact the Customer Care Helpline No.: R.O.I. 01289 8333

Please note the following instructions when sending text messages from fixed lines to all mobile networks.

Sending a Text Message from Fixed Line to Fixed Line

There are no special requirements when sending a text message between fixed lines. Please follow the instructions under **Writing and Sending a New Message**.

Sending a Text Message from Fixed Line to Mobile

There are no special requirements when sending a text message from fixed line to mobile. Please follow the instructions under **Writing and Sending a New Message**. To enable the person receiving your message to reply, the server will insert your telephone number, within hash symbols, at the very end of your message. E.g. #01234 567899#. Please note: If you have used up the full 160 characters for your text message, your telephone number will overwrite the last letters of your message.

Sending a Text Message from Mobile to Fixed Line

There are special requirements when sending a text message from a mobile to a fixed line. If the mobile sender is unaware of the fixed line SMS providers requirements for sending a text message to a fixed line, please inform them of the following procedures.

Example: A Mobile is Replying to a Fixed Line Text Message

- **Select reply to message.**
- **Input your text message.**
- **Within the text message, enter the fixed line phone number.**
The number can be added anywhere within the message but it must be entered with a hash at the beginning and end of the number.
E.g. #01234 567899#
- **Select send.**

Example: Mobile is Writing/Sending a New Text Message to a Fixed Line

- **Input your text message.**
- **Within the text message, enter the fixed line phone number.**
The number can be added anywhere within the message but it must be entered with a hash at the beginning and end of the number.
E.g. #01234 567899#
- **Send the message (including number) to Big Mobile on: 07786 201010.**









SMS Feature (Text Message)

All SMS features must be accessed with the cordless handset. The base unit display does not show any text message. It shows only "Receiving New SMS" when a message is being received, and "Transferring Message" when a message is being transferred.



You can send and receive text messages between other fixed and mobile phones that also support a compatible SMS feature and network. The SMS feature is available only after subscribing to Caller ID.

◆◆ Writing and Sending a New Message

You can write and send a new message. Each message can contain up to 160 characters. To exit the operation, press  at any time.





1 Press JOYSTICK (or move). 	2 Select "SMS".  →  	3 Select "Create".  →  
4 Enter Message. (p.55)	5 Press JOYSTICK , then "Destination" is displayed.  	
Go to step 6.		

◆ Entering a Number Manually

Follow steps 1 to 5 shown above, then:	
6 Enter Phone Number. (max. 20 digits)	Press JOYSTICK .  
Go to step 7 on the next page.	

◆ Entering a Number from the Handset Phonebook

You cannot select items stored in the base unit phonebook.

Follow steps 1 to 5 shown above, then:	
6 Press LEFT SOFT KEY . 	Select the desired item (p.41 - 43).  →   twice
Go to step 7 on the next page.	

SMS Feature (Text Message)

◆ Entering a Number from the Caller ID List

Follow steps 1 to 5 on the previous page, then:

6 Select the desired item.



Go to step 7.

◆ Entering a Number from the Redial List

Follow steps 1 to 5 on the previous page, then:

6 Press **RIGHT SOFT KEY**. Select the desired item.



Go to step 7.

Follow steps 1 to 6 on the previous page and above, then:

7 "Save?" is displayed, then select "Yes" or "No". (If "Yes" is selected, "Saved Message" is displayed.)





8 Select "Send".

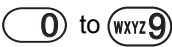

- "Sending Message" is displayed after step 8. The display returns to the standby mode, then "Transferring Message" is displayed on both cordless handset and base unit display.
- Once you have created a SMS message, the unit will display "▲Use Last Text?" each time you select "Create". If you want to use the text of the last message sent once again, move the **JOYSTICK** up to recall the last message.
- If you try to send a message using a phone number (Destination) over 20 digits long from one of the Handset Phonebook, Caller ID or Redial lists, "Invalid Number" is displayed and the display returns to "<Enter Phone No>".
- The maximum message length is 160 characters. Please consult your SMS service provider for further details.
- 69 messages can be memorized when you enter 80 characters/1 message.
- If your phone is connected to PBX (Private Branch eXchange: private branch exchange), see page 63 to enter the destination number.

SMS Feature (Text Message)

◆◆ Text Entry

Keys	Operations
	Move the JOYSTICK up, down, left or right to move the cursor.
	Press to enter letters/numbers. (Items are added to the left of the cursor. If the cursor is at the beginning of a line, the item is added at the beginning.)
	Press to delete characters. (Character on the cursor is deleted. To delete all characters, press and hold.)
	Press to switch between upper and lower case.
	Press to insert a blank space (except when in Numeric input mode).
	Press to insert symbol (* , # , / , etc.) (except when in Numeric input mode).

◆ Selecting the Input Mode

There are 5 text input modes: **LetterWise**[®] (default mode), Alphabet (ABC), Numeric (0-9), Greek (ΑΒΓ) and Extended (ΑĂĂ). The function icon above the key displays the current input mode. For the full character map, see **SMS Character Table** (p.125).

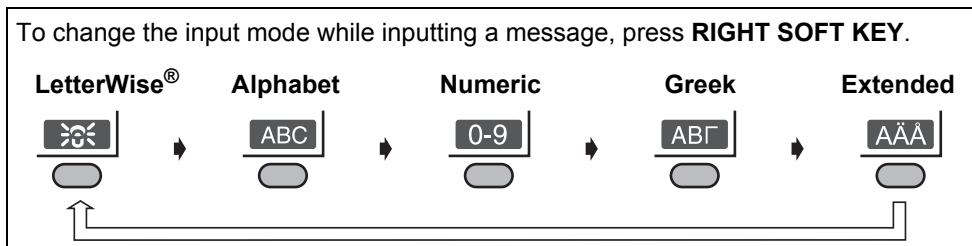

- If **LetterWise**[®] (see next page) is selected, select a language you require (p.75).

SMS Feature (Text Message)

◆◆ Entering Text in LetterWise® Mode

LetterWise® is the default input mode. **LetterWise®** is a simplified text entry system. This system suggests to the user the most likely letter to follow the text entered previously.

Inserting Operations
Enter letters by pressing (ABC 2) - (WXYZ 9).
If the letter displayed is not correct, change the letter by pressing (#) (possibly several times).
Continue writing the word always checking that the letters displayed are correct and change them if necessary.
To insert symbols, use (1). If the symbol you want does not appear, press (#) repeatedly until the required symbol appears.

Example (When the language choice is English.): To enter “hello”.

1 Press (↵) to change to the lower case letter.	<input type="text" value="Enter Message"/>
2 Press (1). “i” is the most frequent first letter of a word.	<input type="text" value="i"/>
3 Press (#) to display the next candidate letter. “h” is the second most frequent letter.	<input type="text" value="h"/>
4 Press (DEF 3). “e” is the most frequent letter.	<input type="text" value="he"/>
5 Press (JKL 5). “l” is the most frequent letter.	<input type="text" value="hel"/>
6 Press (JKL 5). “l” is the most frequent letter.	<input type="text" value="hell"/>
7 Press (MNO 6). “o” is the most frequent letter.	<input type="text" value="hello"/>

SMS Feature (Text Message)

◆◆ Reading/Displaying a Message in the Outgoing List



You can display message saved in date/time order.

To exit the operation, press at any time.

◆ Reading/Displaying a Message

1 Press JOYSTICK (or move). 	2 Select "SMS". →	3 Select "Send List". →
4 Select the desired message. →	5 Scroll through the message to read/display. 	6 Press JOYSTICK .
Go to step 7.		

◆ Sending a Message

Follow steps 1 to 6 shown above, then:	
7 Select "Send". →	Follow steps from 6 of Writing and Sending a New Message (p.53, 54).

SMS Feature (Text Message)

◆ Deleting a Message

Follow steps 1 to 6 on the previous page, then:

7 Select "Delete".



8 Select "Yes", then "Deleted" is displayed.



- You can also delete by pressing  then selecting "Yes" on step 4.

◆ Editing a Message

Follow steps 1 to 6 on the previous page, then:

7 Select "Edit Message".



8 Edit Message.

9 Press **JOYSTICK**.



10 When you send to the same destination, press **JOYSTICK** then follow steps from 7 of **Writing and Sending a New Message** (p.54).

OR

Press and hold  then follow steps from 6 of **Writing and Sending a New Message** (p.53 to 54).

◆◆ Receiving a Text Message

When a message has been received, cordless handset display will show the following and a tone will sound. A tone will not sound if the ringer volume setting of the cordless handset is OFF. The base unit display will show only "Receiving New SMS".

Example: Handset Display

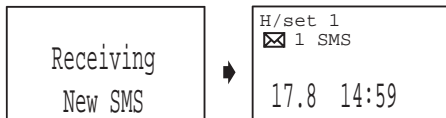

The number indicates how many mails were received. When the SMS message memory is full, "Full" is displayed. No messages can be received if the memory is full.

SMS Feature (Text Message)

◆◆ Reading/Displaying a Message in the Incoming List



To exit the operation, press at any time.

1 Press **JOYSTICK** (or move).

2 Select “ SMS”. →

3 Select “Receive List”. →

☎))	☰
New	2
Total	10

4 Move the **JOYSTICK** down.

- The most recent sender’s details are displayed.
- If the name and number have been stored in the phonebook, the name is also displayed.
- You can delete a message by pressing then selecting “Yes”.

☎))	Date Received
17.8 14:59 ✓	Time Received
JOHN SMITH	Name
0123456789	Tel. No.

5 Select the desired message. →

6 Scroll through the message to read/display.

Go to step 7 on pages 60 and 61.

- If there is a “✓” icon placed against the time, this means the message has been read or displayed previously. It also indicates the other registered cordless handset user have already viewed the message.
- If the list is accessed and no messages have been received, “Receive List Memory Empty” is displayed.
- Some SMS service providers may attach a 1-digit number to the sender’s phone number, the name will not be displayed even if the name and number have been stored in the phonebook.

SMS Feature (Text Message)

◆ Replying to a Message

Follow steps 1 to 6 on the previous page, then:

7 Press **JOYSTICK**.



8 Select "Reply".

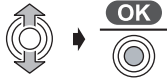

9 Enter Message.

10 Press **JOYSTICK** twice.



11 "Save?" is displayed, then select "Yes" or "No". (If "Yes" is selected, "Saved Message" is displayed.)



12 Select "Send".



- "Sending Message" is displayed after step 12. The display returns to the standby mode, then "Transferring Message" is displayed on both cordless handset and base unit display.

◆ Deleting a Message

Follow steps 1 to 6 on the previous page, then:

7 Press **JOYSTICK**.



8 Select "Delete".



9 Select "Yes", then "Deleted" is displayed.



SMS Feature (Text Message)

◆ Editing a Message

Follow steps 1 to 6 on page 59, then:

7 Press **JOYSTICK**.



8 Select "Edit Message".



9 Edit Message.

10 Press **JOYSTICK**.



11 When you send to the same destination, press **JOYSTICK** then follow steps from 7 of **Writing and Sending a New Message** (p.54).

OR

Press and hold  then follow steps from 6 of **Writing and Sending a New Message** (p.53 to 54).

◆ Storing the Sender's Phone Number in the Handset Phonebook

Follow steps 1 to 6 on page 59, then:

7 Press **JOYSTICK**.



8 Select "Save Phonebook".



9 Follow steps from 4 to 9 of **Storing Caller Information in the Handset Phonebook** (p.37).

◆ Editing the Sender's Phone Number for Call

Follow steps 1 to 6 on page 59, then:

7 Press **JOYSTICK**.



8 Select "Edit for Call".



9 Edit Phone Number.
(max. 24 digits)

10 Press **JOYSTICK**, **TALK** or **SPEAKERPHONE**.



◆ Calling the Message Sender

Follow steps 1 to 5 (or 4) on page 59, then:

6 Press **TALK** or **SPEAKERPHONE**.

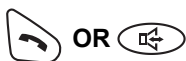

SMS Feature (Text Message)

◆◆ Changing the SMS Message Centre Numbers

To send and receive SMS text messages, you need your SMS Message Centre telephone numbers.











Two numbers have been preset in your unit.

Message Centre 1 number is automatically dialed when sending messages through your network provider.

Message Centre 2 number is automatically dialed when receiving messages through the network provider.

You can change the pre-set numbers if required.

To exit the operation, press  at any time.

1 Press JOYSTICK (or move). 	2 Select "SMS".  → 	3 Select "Parameters".  → 
4 Enter 4-digit Base Unit PIN. (Factory Preset 0000)	5 Select Message Centre 1 or 2.  → 	6 Erase the current number by pressing  , then enter the new Message Centre number.
7 Press JOYSTICK . 	8 Select "Save", then "Saved" is displayed. 	

For your reference, these are the numbers that have been preset in your phone.

Message Centre 1: 0911 023 5029

Message Centre 2: 0161274599











- If your phone is connected to a PBX, you need to add the PBX line access number (and a dialling pause) only to the Message Centre 1 phone number.

SMS Feature (Text Message)

◆◆ Setting the PBX Line Access Number

This feature is only for the phones connected to a PBX. This allows you to delete automatically the PBX line access number (max. 4 digits) when you enter the destination phone number of an SMS outgoing message from Handset Phonebook, Redial or Caller ID lists.









To exit the operation, press  at any time.

1 Press JOYSTICK (or move). 	2 Select "SMS".  → 	3 Select "Parameters".  → 
4 Enter 4-digit Base Unit PIN. (Factory Preset 0000)	5 Select "PBX Prefix".  → 	6 Select "On".  → 
7 Enter Line Access Number. (max. 4 digits)	8 Press JOYSTICK . 	9 Select "Save", then "Saved" is displayed. 

- The factory preset is no entry of line access number.

◆◆ Turning the SMS Feature On/Off

To exit the operation, press  at any time.

1 Press JOYSTICK (or move). 	2 Select "SMS".  → 	3 Select "Parameters".  → 
4 Enter 4-digit Base Unit PIN. (Factory Preset 0000)	5 Select "SMS On/Off".  → 	6 Select "On" or "Off".  → 

When the SMS feature is turned off;

- If you send a message, a tone sounds and the message will return to the SMS incoming list with "FD" attached.
- If you receive from SMS centre call, the message will not be received but SMS centre phone number will remain in the Caller ID list.

- If you turn the SMS feature on, the unit will begin ringing (one ring) after other connected telephones.
- The factory preset is "On".

Settings Menu Chart

◆◆ Handset Settings Menu Chart

1st Menu	2nd Menu	3rd Menu	
Setting Handset	Set Date/Time		
	Memo Alarm		
	Ringer Option		Ringer Volume
			EXT Ringer Type
			INT Ringer Type
			Paging Tone
			Private Ring
	Tone Option		Key Tone
	Display Option		Standby Display
			Talk Display
			Select Language
			Private Colour
			Category Name
	Call Option		Call Bar
			Direct Call No.
			Direct On/Off
	Registration		Register H/set
			Cancel Base
	Select Base		Auto
			Base 1
			⋮ Base 4
	Other Option		Change H/S PIN
			Change H/S Name
			Auto Talk
			Auto Voice Dial
			LetterWise
			Battery Type
		Reset Handset	

Settings Menu Chart

◆◆ Base Unit Settings Menu Chart

1st Menu	2nd Menu	3rd Menu
Setting Base	Call Option	Recall
		Pause Time
		Emergency Call
		Call Restricted
	Cancel Handset	
	Other Option	Change Base PIN
Reset Base		









Handset Settings

All Handset Settings must be operated with the cordless handset.









◆◆ Memo Alarm

Set the date and time before setting the memo alarm (p.20).

To exit the operation, press  at any time.

1 Press JOYSTICK (or move). 	2 Select "  Setting Handset".  → 
3 Select "Memo Alarm".  → 	4 Select the desired alarm number (1-3).  → 
Go to step 5.	

◆ Setting the Alarm Mode "Once" or "Daily"

Follow steps 1 to 4 shown above, then:		
5 Select "Once" or "Daily".  → 	6 "Once": Enter the date and time. "Daily": Enter time. 	7 Press JOYSTICK . 
8 Enter a memo message (max. 32 characters), then press JOYSTICK . 	9 Select the desired ringer pattern.  → 	10 Select "Save", then "Saved" is displayed. 

- When setting the time, remember to select 12 or 24 hour clock (p.20).
- Memo Alarm volume depends on cordless handset ringer volume. Even if you set ringer to off, Memo Alarm still rings.
- The factory preset of ringer pattern is 1.
- When in talk or intercom mode, the alarm will not sound until the call is ended.

◆ Setting the Alarm “Off”

Follow steps 1 to 4 shown on the previous page, then:

5 Select “Off”.



6 Select “Save”, then “Saved” is displayed.











- The factory preset is “Off”.
- To delete the displayed memo alarm, press  then select “Yes” on step 4 on the previous page.

◆ Stopping the Alarm

(The Alarm sounds: Max. 3 minutes)



Press .

- You can also stop the alarm by pressing , ,  to , ,  or .
- If “Once” is selected, the setting is turned off after the alarm.

Handset Settings

◆◆ Ringer Options

There are 15 ringer patterns available on each ringer. “Ringer 1” to “Ringer 6” are the bell ringer patterns. “Ringer 7” to “Ringer 15” are the preset melody patterns as below. The music data in this product belongs to M-ZoNE Co., Ltd.

To exit the operation, press  at any time.











Ringer No.	Ringer Pattern or Name
1 ~ 6	Bell Patterns
Ringer Pattern 7 to 15: Preset Melody Patterns	
7	Symphony No.5 in C minor
8	Air on G String
9	Wholetemperiere Clavier 1 Teil No 1 Fuga Das
10	Fantaisie Impromptu
11	Allegro Spring/The Four Seasons
12	Also Sprach Zarathustra
13	Liebestraum
14	Polovetsian Dance
15	24 Caprices

* © 2003 M-ZoNE Co., Ltd.

- If you select one of the melody ringer patterns, the phone will ring for 10 seconds even if a caller has hung up. Therefore, you may hear a dial tone or no one on the line after you answer a call.

◆ Setting the Ringer Volume





The choices are 6 levels and off. If you set the volume to OFF, “” is displayed, however, the volume of a paging and intercom call is still at level 1.

1 Press JOYSTICK (or move). 	2 Select “  Setting Handset”.  → 	3 Select “Ringer Option”.  → 
4 Select “Ringer Volume”.  → 	5 To increase volume, move the JOYSTICK up. To decrease volume, move the JOYSTICK down. 	6 Press JOYSTICK . 

- The factory preset is 6.

◆ Selecting the Ringer Pattern for External Call/Internal Call/Paging







Follow steps 1 to 3 shown above, then:

4 Select “EXT Ringer Type”, “INT Ringer Type” or “Paging Tone”.  → 	5 Select the desired ringer pattern.  → 
---	--

- The factory preset is 1.

◆ Selecting the Ringer Pattern for Private Ring

Follow steps 1 to 3 shown above, then:

4 Select “Private Ring”.  → 	5 Select the desired category.  → 	6 Select the desired ringer pattern.  → 
--	--	--









- The factory preset of each ringer pattern is 1.

Handset Settings

◆◆ Setting the Handset Key Tone ON/OFF

You can turn the key tone ON/OFF.





To exit the operation, press  at any time.

1 Press JOYSTICK (or move). 	2 Select "Setting Handset".  → 	3 Select "Tone Option".  → 
4 Press JOYSTICK to select "Key Tone". 	5 Select "On" or "Off".  → 	

- The factory preset is "On".





◆◆ Display Options

To exit the operation, press  at any time.

1 Press JOYSTICK (or move). 	2 Select "Setting Handset".  → 	3 Select "Display Option".  → 
Go to step 4.		

◆ Selecting the Standby Mode Display

Follow steps 1 to 3 shown above, then:

4 Select "Standby Display".  → 	5 Select "Base Number", "Handset Name" or "Off".  → 
---	--

- The factory preset is "Handset Name".

◆ Selecting the Talk Mode Display

Follow steps 1 to 3 of **Display Options** on the previous page, then:

4 Select "Talk Display".



5 Select "Talk Time" or "Phone Number".



- Even if you select "Phone Number", the length of the call will appear on your display when you receive calls.
- The factory preset is "Talk Time".

◆ Setting the Private Colour

Follow steps 1 to 3 of **Display Options** on the previous page, then:

4 Select "Private Colour".



5 Select the desired category.



6 Select Private Colour "Green", "Red" or "Orange" for each category.



- The factory preset is "Green".
- When you select the private colour on step 6, the Ringer LED will flash at the selected colour.

◆ Changing the Category Name

Follow steps 1 to 3 of **Display Options** on the previous page, then:

4 Select "Category Name".



5 Select the desired category.



6 Edit Category Name.
(max. 10 characters: p.39)









7 Press **JOYSTICK**.



Handset Settings

◆◆ Call Options







To exit the operation, press  at any time.

1 Press JOYSTICK (or move). 	2 Select “  Setting Handset”.  →  	3 Select “Call Option”.  →  
Go to step 4.		

◆ Call Bar ON/OFF



When this feature is set to ON, outgoing calls cannot be made. Intercom calls and calls to numbers assigned as emergency numbers can be made (see **Setting the Emergency Call Numbers** on page 78).

Follow steps 1 to 3 shown above, then:











4 Select “Call Bar”.  →  	5 Enter 4-digit Handset PIN. (Factory Preset 0000)	6 Select “on” or “Off”.  →  
---	--	--

- The factory preset is “Off”.
- While the call prohibition mode is turned on, “” is displayed.

◆ Setting the Direct Call Number

After a direct call number has been set and the feature has been turned on, you can dial only the direct call number by pressing  or , when this feature is ON, emergency call cannot be made. However, incoming calls can be answered.

Follow steps 1 to 3 shown above, then:

4 Select “Direct Call No.”.  →  	5 Enter Direct Call Number. (max. 24 digits)	6 Press JOYSTICK .  
7 Select “Save”.  	8 Select “On”.  →  	

- While the direct call mode is turned on, “” is displayed.

◆ Setting the Direct Call ON/OFF

Follow steps 1 to 3 of on the previous page, then:

4 Select "Direct On/Off".



5 Select "On" or "Off".









- The factory preset is "Off".
- If the direct call mode is turned off, "☎" will disappear.
- If you did not set the Direct Call Number and select "On" in step 5, "Enter Phone No" will be displayed. Enter the number then press  twice.

Handset Settings

◆◆ Other Options

To exit the operation, press  at any time.



1 Press JOYSTICK (or move). 	2 Select "  Setting Handset".  → 	3 Select "Other Option".  → 
Go to step 4.		

◆ Changing Handset PIN (Personal Identification Number)

The factory preset is 0000.



Once you have programmed the handset PIN, you cannot confirm it. We recommend you write down the handset PIN. If you forget it, please consult our Panasonic Customer Care Helpline. U.K. 08700 100 076 R.O.I. 01289 8333

Follow steps 1 to 3 shown above, then:

4 Select "Change H/S PIN".  → 	5 Enter current 4-digit Handset PIN.
6 Enter new 4-digit Handset PIN.	7 Enter new 4-digit Handset PIN again to verify.

◆ Changing Handset Name

Follow steps 1 to 3 shown above, then:

4 Select "Change H/S Name".  → 	5 Edit Handset Name. (max. 10 characters)	6 Press JOYSTICK . 
--	---	---

◆ Setting Auto Talk ON/OFF

Follow steps 1 to 3 on the previous page, then:

4 Select "Auto Talk".



5 Select "On" or "Off".



- The factory preset is "Off".

◆ Auto Voice Dial ON/OFF

Follow steps 1 to 3 on the previous page, then:

4 Select "Auto Voice Dial".



5 Select "On" or "Off".



- The factory preset is "Off".

◆ Changing the LetterWise® Language

Follow steps 1 to 3 on the previous page, then:

4 Select "LetterWise".



5 Select the desired language.



- The factory preset is "English".

◆ Setting the Battery Type

Follow steps 1 to 3 on the previous page, then:

4 Select "Battery Type".



5 Select "Ni-Cd" or "Ni-MH".













- The factory preset is "Ni-MH".
- After you set the battery type,  is shown on the handset display.

Handset Settings

◆ Reset the Handset Settings

You can reset all of the handset settings to their initial settings.

<p>1 Press JOYSTICK (or move).</p> 	<p>2 Select “ Setting Handset”.</p>  → 	<p>3 Select “Other Option”.</p>  → 
<p>4 Select “Reset Handset”.</p>  → 	<p>5 Enter 4-digit Handset PIN. (Factory Preset 0000)</p>	<p>6 Select “Yes”, then “Deleted” is displayed.</p>  → 

◆ Initial Settings for Cordless Handset





Functions	Initial Settings
Display Language	English
4-Digit Handset PIN	0000
Phonebook List	Remain
Voice Tag	Remain
Select Base	Automatic Base Unit Selection
Redial Memory	Delete All
Walkie-Talkie Setting	Group
Private Colour	Green
Category Name	Remain
Handset Name	Remain
Date/Time	Remain

- All of the other handset settings are cleared or turned to their factory preset when you reset the handset settings.

Call Options and Other Options of Base Unit Settings must be operated with the cordless handset.







◆◆ Call Options

To exit the operation, press  at any time.

1 Press JOYSTICK (or move). 	2 Select "Setting Base".  → 	3 Enter 4-digit Base Unit PIN. (Factory Preset 0000)
4 Select "Call Option".  → 	Go to step 5.	

◆ Selecting the Flash/Earth Mode

You can change the duration of the recall time depending on the requirements of your network provider or PBX.

Follow steps 1 to 4 shown above, then:	
5 Select "Recall".  → 	6 Select "Flash" or "Earth".  → 
When "Flash" is selected;	
7 Select the desired flash type. (see below)  → 	

- The factory preset is "Flash".

"Type 1": 700 ms, "Type 2": 80 ms, "Type 3": 400 ms. The factory preset is "Type 2".

Base Unit Settings

◆ Selecting the Pause Time

You can select the pause time to 3 or 5 seconds, depending on your PBX requirements.

Follow steps 1 to 4 on the previous page, then:

5 Select "Pause Time".



6 Select "Short" (3 sec.) or "Long" (5 sec.).



- The factory preset is "Short".

◆ Setting the Emergency Call Numbers

This is to enable you to make an emergency call even in call bar mode.

Follow steps 1 to 4 on the previous page, then:

5 Select "Emergency Call".



6 Select "Emergency Call1" to "Emergency Call5".



7 Enter Emergency Call Number.
(max. 24 digits)

8 Press **JOYSTICK**.



- The factory presets are **112** and **999**.

◆ Call Restriction

You can restrict selected cordless handset(s) or the base unit from dialling selected phone numbers. You can assign up to 6 call restriction numbers (up to 8 digits). If you dial a restricted number, the call does not connect and the restricted number flashes.

Follow steps 1 to 4 on **Call Options** (p.77), then:

5 Select "Call Restricted".



6 Search and press **RIGHT SOFT KEY** to attach (or cancel) "✓" to the desired Cordless Handset(s) or Base Unit to restrict.



7 Press **JOYSTICK**.



8 Select the restricted Number item (1-6).



9 Enter the restricted phone number (up to 8 digits).

10 Press **JOYSTICK**.











NOTE: When you put a first digit on step 9, it must overwrite the current displayed numbers. We recommend you to write down the restricted phone number you entered.

Base Unit Settings

◆◆ Other Options



To exit the operation, press  at any time.

1 Press JOYSTICK (or move). 	2 Select “  Setting Base”.  →  	3 Enter 4-digit Base Unit PIN. (Factory Preset 0000)
4 Select “Other Option”.  →  	Go to step 5.	

◆ Changing the Base Unit PIN (Personal Identification Number)







The factory preset is 0000.

Once you have programmed the base unit PIN, you cannot confirm it. We recommend you write down the base unit PIN. If you forget it, please consult our Panasonic Customer Care Helpline. U.K. 08700 100 076 R.O.I. 01289 8333

Follow steps 1 to 4 shown above, then:		
5 Select “Change Base PIN”.  →  	6 Enter new 4-digit Base Unit PIN.	7 Enter new 4-digit Base Unit PIN again to verify.

◆ Reset the Base Unit Settings

You can reset all of the base unit settings to their initial settings.

Follow steps 1 to 4 shown above, then:	
5 Select “Reset Base”.  →  	6 Select “Yes”, then “Deleted” is displayed.  →  

Base Unit Settings

◆ Initial Settings for Base Unit

Function	Initial Setting
4-Digit Base Unit PIN	0000
Base Unit External Ringer Pattern	1
Base Unit Receiver Volume	Medium
Call Bar Mode	OFF
Display Language	English
Redial Memory	Delete All
Phonebook List	Remain
SMS Message Centre Number 1	0911 023 5029
SMS Message Centre Number 2	0161274599
Caller ID List	Delete All
SMS Message Lists	Delete All
SMS PBX Line Access Number Support ON/OFF	OFF
SMS PBX Line Access Number	Delete All
SMS Feature	ON
Date/Time	31-12-03/00:00
Answering System	ON
Your Own Greeting Message	Remain
Caller's Recording Time	No Limit
Number of Rings	4 Rings
Greeting Monitor	ON
Remote Code	Delete (OFF)
Incoming/Memo Message(s)	Remain



- All of the other base unit settings are cleared or turned to their factory preset when you reset the base unit settings.

Operations Performed with the Base Unit

◆◆ Making a Call from the Caller ID List

Please see page 30 for more feature description.

To exit the operation, press  at any time.



1 Press RIGHT SOFT KEY. 	➔ The newest caller information is displayed.	2 Select the desired item. 
3 Lift the handset.		

- You can also press  to make a call.
- “√” indicates you have already viewed this caller information, or answered the call. It also indicates the registered cordless handset user has already viewed this caller information, or answered the call.
- If the caller has requested not to display his/her information, the display shows “Private Caller”.
- If the caller dialed from an area which does not provide Caller ID service, the display shows “Out of Area”.
- When scrolling reaches the end of the list, an end tone will sound.

◆◆ Caller ID List Menu

You can edit (for calling) or delete item(s) in the Caller ID List.

To exit the operation, press  at any time.

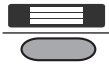
1 Press RIGHT SOFT KEY. 	➔ The newest caller information is displayed.	2 Select the desired item.  ➔ 
Go to step 3.		

- When scrolling reaches the end of the list, an end tone will sound.
- If there are no items stored in the caller list when  is pressed, the base unit display shows “Memory Empty”.

Operations Performed with the Base Unit

◆ Editing the Received Number for Calling

Follow steps 1 to 2 of **Caller ID List Menu** on the previous page, then:

3 Select “Edit for Call”.



4 Edit Phone Number. (max. 24 digits)

5 Press **MIDDLE SOFT KEY**.



- You can also press to make a call.
- If you press to or after step 3, the first digit of the phone number will be inserted.

◆ Deleting One/All Caller ID Item(s)

Follow steps 1 to 2 of **Caller ID List Menu** on the previous page, then:

3 Select “Delete” or “Delete All”.



4 Select “Yes” then “Deleted” is displayed.





- To delete the displayed item, press then select “Yes” on step 2 of **Caller ID List Menu** (p.82).

Operations Performed with the Base Unit



◆◆ Redial List Menu

You can edit (for calling) or delete item(s) in the redial List.
To exit the operation, press  at any time.

1 Press REDIAL . 	The last number dialled is displayed.	2 Search for the desired dialled item.  → 
Go to step 3.		





◆ Editing the Dialed Number for Calling

Follow steps 1 to 2 shown above, then:

3 Select “Edit for Call”.  → 	4 Edit Phone Number. (max. 24 digits)	5 Lift the handset or press MIDDLE SOFT KEY . 
---	--	--

◆ Deleting One/All Redial Item(s)

Follow steps 1 to 2 shown above, then:

3 Select “Delete” or “Delete All”.  → 	4 Select “Yes”, then “Deleted” is displayed.  → 
--	--

- To delete the displayed item, press  then select “Yes” on step 2.

Operations Performed with the Base Unit

◆◆ Finding Items in the Base Unit Phonebook

Storing (p.38)/Editing (p.45)/Deleting (p.46) items in the base unit phonebook can be operated with cordless handset.

To exit the operation, press  at any time.

- 1** Press
LEFT SOFT KEY.



- ➔ The first base unit phonebook item is displayed.

- 2** Select the desired item.



◆◆ Dialling from the Base Unit Phonebook

To exit the operation, press  at any time.

- 1** Press
LEFT SOFT KEY.



- ➔ The first base unit phonebook item is displayed.

- 2** Select the desired item.



- 3** Lift the handset.

- You can also press  to make a call.

Operations Performed with the Base Unit







◆◆ Ringer Options

The choices for the base unit ringer volume are 3 levels and off.

If you set the volume to OFF, “” is displayed.

To exit the operation, press  at any time.







◆ Setting the Base Unit Ringer Volume

1 Press MIDDLE SOFT KEY. 	2 Select “Ringer Option”.  → 	3 Select “Ringer Volume”.  → 
4 To increase volume, press NAVIGATOR KEY up. To decrease volume, press NAVIGATOR KEY down. 	5 Press MIDDLE SOFT KEY. 	

- The factory preset is medium.

◆ Setting the Base Unit Ringer Pattern for External Call

The choices for the base unit ringer pattern for external call are 6 patterns.

1 Press MIDDLE SOFT KEY. 	2 Select “Ringer Option”.  → 	3 Select “EXT Ringer Type”.  → 
4 Select the desired ringer pattern.  → 		





- The factory preset is 1.

Operations Performed with the Base Unit

◆◆ Call Bar ON/OFF

When this feature is set to ON, outgoing calls cannot be made. Intercom calls and calls to numbers assigned as emergency numbers can be made (see **Setting the Emergency Call Numbers** on page 78).

To exit the operation, press  at any time.

1 Press MIDDLE SOFT KEY. 	2 Select "Call Bar".  → 	3 Enter 4-digit Base Unit PIN. (Factory Preset 0000)
4 Select "On" or "Off".  → 		

- The factory preset is "Off".
- While the call prohibition mode is turned on, " " is displayed.

Multi-Unit User Operations

◆◆ Operating Additional Cordless Handsets

Additional **KX-TCA151E** or **KX-TCA154E** cordless handsets are available for purchase separately. Up to 6 cordless handsets can be registered to a single base unit. Using additional cordless handsets allows you to have an intercom call while simultaneously conducting a call to an outside line.

KX-TCA151E does not have Voice Search feature.

◆◆ Operating Additional Base Units

You can register and operate your cordless handset with up to 4 base units. Each base unit forms 1 radio cell. If the individual bases are linked to the same telephone line then you can extend the operating range of the system by positioning the bases so that the cordless two radio cells overlap. If the cordless handset is set to auto base selection, then in standby mode the cordless handset will automatically swap to the second base if the range on the first base is exceeded. It is not possible to transfer calls between bases (only between cordless handsets linked to the same base unit).

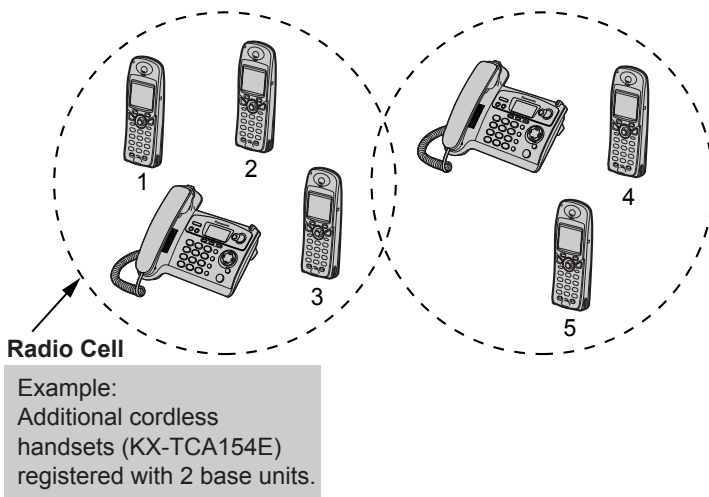

NOTE: Calls are disconnected when the cordless handset moves from one radio cell to another.

Multi-Unit User Operations

◆◆ Cordless Handset Registration to a Base Unit













The cordless handset supplied with the base unit is already registered. If an optional cordless handset is purchased, it must be registered as follows.

Charge the optional cordless handset batteries for 7 hours before initial use.

Cordless handset registration must be completed within 1 minute after pressing

. If over 1 minute, press  then start over again.

To exit the operation, press  at any time.

1 Press JOYSTICK (or move). 	2 Select "  Setting Handset".  → 	3 Select "Registration".  → 
4 Select "Register H/set".  → 	5 Press and hold  button on the Base Unit (for about 3 seconds) until the tone sounds.	
6 Select the desired base unit.  → 	7 Enter 4-digit Base Unit PIN. (Factory Preset 0000)	8 Press JOYSTICK . 

When a cordless handset is registered successfully, a confirmation tone sounds and the "" icon is displayed.

- If you enter the incorrect Base Unit PIN, an error tone sounds. Repeat from step 1.
- To register a cordless handset to more than one base unit, repeat from step 1 with the other base unit(s).
- The cordless handset main menu may change depending on the base unit that the cordless handset is registered to.













Multi-Unit User Operations



◆ Cancelling a Cordless Handset

Each cordless handset can cancel itself or another cordless handsets. This feature is usually used to cancel a link between Cordless Handset and Base Unit.

To exit the operation, press  at any time.











1 Press JOYSTICK (or move). 	2 Select “  Setting Base”.  →  
3 Enter 4-digit Base Unit PIN. (Factory Preset 0000)	4 Select “Cancel Handset”.  →  
5 Search and press RIGHT SOFT KEY to attach “√” to the handset(s) to cancel.  → 	6 Press JOYSTICK .  

◆ Cancelling a Base Unit

If a cordless handset is out of range and/or power is OFF when **Cancelling a Cordless Handset**, the previous base unit number will still remain in the cancelled cordless handset. Therefore, you need to cancel the base unit registered in the cancelled cordless handset.

To exit the operation, press  at any time.

Follow steps **1** to **3** on the previous page, then:

4 Select “Cancel Base”.  →  	5 Enter 4-digit Handset PIN. (Factory Preset 0000)
6 Search and press RIGHT SOFT KEY to attach “√” to the base unit to cancel.  → 	7 Press JOYSTICK .  
8 Select “Yes”, then “Deleted” is displayed.  →  	











◆◆ Base Unit Selection

When "Auto" (Automatic Base Unit Selection) is selected, the cordless handset automatically searches for other registered base units if you move outside of the radio range of the current base unit.

When a specified base unit is selected, the cordless handset will access that base unit only.

Calls (both incoming and outgoing) can be conducted only via the selected base unit, even if the radio cells overlap with neighbouring base units.

To exit the operation, press  at any time.

1 Press JOYSTICK (or move). 	2 Select "  Setting Handset".  →  
3 Select "Select Base".  →  	4 Select "Auto" or desired base unit.  →  

- The factory preset is "Auto".





Multi-Unit User Operations

◆◆ Intercom Between Registered Units

You can use your cordless handsets and base unit as a 2-way intercom. **Intercom calls can be conducted within the radio cell of the current base unit, but not with units in neighbouring radio cells.**

To exit the operation, press  at any time.

◆ Example: Cordless Handset 1 calls Cordless Handset 2



<p>1</p> <p>2</p>	<p><Cordless Handset 1></p> <p>Press INTERCOM , then press the desired cordless handset number .</p>	<p><Cordless Handset 2></p> <p></p> <p>Press TALK .</p>
---------------------------------	---	--



- You can also answer a call by pressing ,  to , ,  or  instead of pressing  (**Any Key Talk**).

◆ Terminating a Call



<p>3</p>	<p><Cordless Handset 1 or 2></p> <p>Press TALK OFF .</p>
-----------------	--

◆ Example: Cordless Handset 1 calls Base Unit

<p>1</p> <p>2</p>	<p><Cordless Handset 1></p> <p>Press INTERCOM , then press the base unit number .</p>	<p><Base Unit></p> <p></p> <p>Lift the handset.</p>
---------------------------------	--	---





- You can also answer a call by pressing  or .









◆ Terminating a Call

<p>3</p>	<p><Cordless Handset 1></p> <p>Press TALK OFF .</p>	<p><Base Unit></p> <p>To hang up, place the handset on the cradle or press .</p>
-----------------	---	---



Multi-Unit User Operations

◆ Example: Base Unit calls Cordless Handset 1

	<Base Unit>	<Cordless Handset 1>
1	Press INTERCOM  .	
2	Select the desired cordless handset number  .	
3		Press TALK  .

- You can call all cordless handsets from the base unit at once if you press  on step **2 (Selecting the Ringer Pattern for Paging: see page 69)**, then the cordless handset user who answers first can talk to the base unit user.
- You can also answer a call by pressing ,  to , ,  or  instead of pressing  (**Any Key Talk**).

◆ Terminating a Call

	<Base Unit>		<Cordless Handset 1>
4	To hang up, place the handset on the cradle or press  .	OR	Press TALK OFF  .

Multi-Unit User Operations





◆◆ Transferring a Call to Another Registered Unit















The intercom can be used during a call to transfer an external call between registered units.

To exit the operation, press  at any time.

◆ Example: Cordless Handset 1 transfers a call to Cordless Handset 2





	<Cordless Handset 1>	<Cordless Handset 2>
	(During a call)	
1	Press INTERCOM  , then press the desired cordless handset number  .	
2		Press TALK  .
	(Conversation between Cordless Handset 1 and 2)	
3	Press TALK OFF  .	
	(Conversation between outside line and Cordless Handset 2)	









- When you press  on the cordless handset during a call, an outside line will be held. To return to the conversation, press  again.
- During an outside line is put on hold, and if the transferred call is not answered, you can return to the conversation by pressing  again.
- You can also answer a call by pressing ,  to , ,  or  instead of pressing  (**Any Key Talk**).
- If you press  after pressing the desired cordless handset number, a call can be transferred to another cordless handset without speaking to another cordless handset.
If the transferred call is not answered within 60 seconds, Cordless Handset 1 will ring again.
- When Cordless Handset 2 answers a transferred call, press  to establish a **conference call** or press  to complete a call transfer.

Multi-Unit User Operations

To exit the operation, press  at any time.





◆ Example: Cordless Handset 1 transfers a call to Base Unit











	<Cordless Handset 1>	<Base Unit>
	(During a call)	
1	Press INTERCOM  , then press the base unit number  .	
2		Lift the handset.
	(Conversation between Cordless Handset 1 and Base Unit)	
3	Press TALK OFF  .	
		(Conversation between outside line and Base Unit)

- When you press  on the cordless handset during a call, an outside line will be held. To return to the conversation, press  again.
- During an outside line is put on hold, and if the transferred call is not answered, you can return to the conversation by pressing  again.
- You can also answer a call by pressing  or .
- If you press  after pressing the base unit number, a call can be transferred to base unit without speaking to base unit.
If the transferred call is not answered within 60 seconds, Cordless Handset 1 will ring again.
- When Base Unit answers a transferred call, press  to establish a **conference call** or press  to complete a call transfer.

Multi-Unit User Operations

◆ Example: Base Unit transfers a call to Cordless Handset 1

	<Base Unit>	<Cordless Handset 1>
	(During a call)	
1	Press INTERCOM  , then press the desired cordless handset number  .	
2		Press TALK  .
	(Conversation between Base Unit and Cordless Handset 1)	
3	To hang up, place the handset on the cradle or press  .	(Conversation between outside line and Cordless Handset 1)

- When you press  on the base unit during a call, an outside line will be held. To return to the conversation, press  again.
- During an outside line is put on hold, and if the transferred call is not answered, you can return to the conversation by pressing  again.
- You can also answer a call by pressing ,  to , ,  or  instead of pressing  (**Any Key Talk**).
- If you hang up after pressing the desired cordless handset number, a call can be transferred to the cordless handset without speaking to the cordless handset. If the transferred call is not answered within 60 seconds, Base Unit will ring again.
- When Cordless Handset 1 answers a transferred call, press  to establish a **conference call** or hang up to complete a call transfer.

The Walkie-Talkie feature allows cordless handsets to communicate with each other outside the range of the base unit. When the cordless handsets are in Walkie-Talkie mode, external calls cannot be received. Only KX-TCA151E and KX-TCA154E with Walkie-Talkie feature can communicate with one another.

Talk time in this mode is approximately 6 hours. Standby time in this mode is approximately max. 15 hours. (It changes by the use conditions.) When using the cordless handset in Walkie-Talkie mode, we recommend keeping the cordless handset turned off, turning it on only when talking in Walkie-Talkie mode. Turning the cordless handset off immediately after use will improve battery operating time.

Range:

The maximum range between two cordless handsets while in Walkie-Talkie mode is up to 300 metres outdoors.

◆◆ Setting the Walkie-Talkie Mode

You can set the Walkie-Talkie mode. There are two types: Common Base Station mode and Group mode. The factory preset is Group mode.

- In Common Base Station mode, communication is possible between cordless handsets registered to a common base unit. If the cordless handsets are registered to more than one base unit, the same base unit must be selected.

Please note, the feature will not operate if AUTO is set in the base unit selection.

If Common Base Station mode is selected and the cordless handset is not registered to a base unit, an error tone sounds.

- In Group mode, communication is possible between cordless handsets that are both set to Walkie-Talkie mode and have the same common Group ID. This allows cordless handsets to communicate in Walkie-Talkie mode regardless of which base unit they are registered to.

Walkie-Talkie

To exit the operation, press  at any time.

1 Press **JOYSTICK**
(or move).



2 Select “Walkie-Talkie”.



3 Select “Setting”.



4 Select “Common” or “Group”.



When “Group” is selected;

5 Enter 3-digit Group Code.
(Factory Preset 000)

6 Press **JOYSTICK**.



7 Enter Cordless Handset Number.
(1-9: Factory Preset is 1)

8 Press **JOYSTICK** twice.



- If you select “Group”, enter Group Code (this can be 3 digits of your choice - the factory preset is 000). Make note of your code.
- The factory preset of Cordless Handset Number is 1.





IMPORTANT: Each cordless handset should have its own unique number.

◆◆ Turning the Walkie-Talkie Mode On/Off

To use the Walkie-Talkie feature, all cordless handsets in conversation must be in Walkie-Talkie mode.



To exit the operation, press  at any time.

◆ Turning the Walkie-Talkie Mode On

1 Press JOYSTICK (or move). 	2 Select “  Walkie-Talkie”.  → 	3 Select “On”.  → 
---	--	--

- When the Walkie-Talkie mode is ON, the cordless handset number is displayed after “Walkie-Talkie” appears on the display.

◆ Turning the Walkie-Talkie Mode Off

1 Press JOYSTICK . 	2 Select “Off”.  → 
---	---







- This feature is also turned off if you turn power off then on.

◆◆ Talking in Walkie-Talkie Mode

Before proceeding with this function, please ensure Walkie-Talkie mode is turned on, and the appropriate Walkie-Talkie mode has been selected.

For example, Cordless Handset 1 is calling Cordless Handset 2.

To exit the operation, press  at any time.

	<Cordless Handset 1>	<Cordless Handset 2>
1	Press INTERCOM  ,  or  , then press the desired cordless handset number  .	
2		Press TALK  .

- You can also answer a call by pressing ,  to , ,  or  instead of pressing  (**Any Key Talk**).

Answering System

If you set the current date and time (p.20) and set the answering system ON, a synthesized voice announce the date and time an/a incoming/memo message was recorded after playback-**Voice Date/Time Stamp**.







The total recording capacity is approximately 30 minutes or 64 messages. The greeting recording time is limited to 2 minutes and 30 seconds. We recommend you to record a brief greeting message in order to leave more time for recording new incoming/memo messages. All messages (greeting, incoming and memo) are stored indefinitely on a "Flash memory" IC chip-even if a power failure occurs. All of the messages are saved until you erase them-**Flash Memory Message Backup**.

◆◆ Answering System ON/OFF







When you set the answering system ON, a caller can leave her/his messages.



◆ Setting ON

1 Press JOYSTICK (or move). 	2 Select "  TAM Operation".  → 	3 Select "Answer On", then  is displayed.  → 
--	--	--

◆ Setting OFF

1 Press JOYSTICK (or move). 	2 Select "  TAM Operation".  → 	3 Select "Answer Off", then  is disappeared.  → 
--	--	---



◆ Setting ON

Press ANSWER ON . 	➔ Indicator lights on.
---	------------------------

◆ Setting OFF

Press ANSWER ON again. 	➔ Indicator lights off.
--	-------------------------

◆◆ Greeting Message

◆ Playing Back Pre-Recorded/Your Own Greeting Message

If you do not record your own greeting message, one of two pre-recorded greeting messages will be played. A pre-recorded greeting message depends on the selecting of same phone caller's recording time.

When the recording time is set to "1 Minute" or "No Limit" (30 minutes).









- "Hello, we are not available now. Please leave your name and phone number after the beep. We will return your call."

When the recording time is set to "Greeting Only".

- "Hello, We are not available now. Please call again. Thank you for your call."









◆ Recording Your Own Greeting Message

1 Press JOYSTICK (or move). 	2 Select "TAM Operation".  → 	3 Select "Record".  → 
4 Select "Record OGM".  → 	5 Record Greeting Message. 20 cm away from the Mic.	6 Press JOYSTICK to finish recording then the recorded message is playback. 



◆ Selecting the Caller's Recording Time

Follow steps 1 to 2 shown above, then:

3 Select "Setting TAM".  → 	4 Select "Msg Rec Time".  → 	5 Select "1 Minute" or "No Limit" (up to 30 minutes) or "Greeting Only" (no incoming message will be recorded).  → 
---	--	---

- The factory preset is "No Limit".

Answering System



◆ Recording Your Own Greeting Message

1 Press and hold **GREETING**.



2 Record Greeting Message. **20 cm** away from the Mic (p.8).

3 Press **GREETING** to finish recording.



- The recorded your own greeting message will be played after step **3**.
- You can also finish recording by pressing .



◆ Playing Back a Greeting Message

1 Press **JOYSTICK** (or move).



2 Select "  TAM Operation".



3 Select "Play OGM".



◆ Playing Back a Greeting Message

Press **GREETING**.









◆ A greeting message playback.

- You can delete your own greeting message by pressing  during playing your own greeting message.

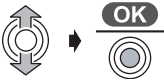

◆ Deleting Your Own Greeting Message

<p>1 Press JOYSTICK (or move).</p> 	<p>2 Select "TAM Operation".</p> 	<p>3 Select "Delete Message".</p> 
<p>4 Select "Delete OGM".</p> 	<p>5 Select "Yes", then "Deleted" is displayed.</p> 	

- You can also delete your own greeting message by pressing  then select "Yes" during playing your own greeting message.

◆◆ Selecting the Number of Rings

You can select the number of times the unit rings before the answering system answers a call, from 2 to 7 or Auto (for **Toll Saver**; as below).





◆ Toll Saver (When set to "Auto")

When you call the unit from a touch tone telephone:

If the unit answers on the 2nd or 3rd ring, there is at least one new message.

If the unit answers on the 5th or 6th ring, there are no new messages.

Hang up when you hear the 4th ring. This will save you the toll charge for the call.

<p>1 Press JOYSTICK (or move).</p> 	<p>2 Select "TAM Operation".</p> 	<p>3 Select "Setting TAM".</p> 
<p>4 Select "Number of Rings".</p> 	<p>5 Select "Auto" or "2 Rings" to "7 Rings" to select the number of rings.</p> 	

- The factory preset is "4 Rings".

Answering System

◆◆ Incoming/Memo Messages

Incoming messages and memo messages are stored in chronological order. New messages cannot be recorded when “Full” is displayed and  indicator on the base unit flashes rapidly. We recommend you erase unnecessary messages after each playback to leave more time for recording new message(s).

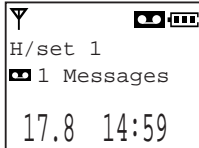

If new message(s) is (are) recorded,  icon and the number of new messages will be displayed.

◆ Playing New Incoming/Memo Message(s)

1 Press **JOYSTICK**
(or move).



2 Select “ TAM
Operation”.



3 Select “Play New
Msg.”.



◆ Playing All Incoming/Memo Messages

1 Press **JOYSTICK**
(or move).



2 Select “ TAM
Operation”.



3 Select “Play All
Msg.”.



◆ Repeating a Message During Playback

(During Playing
Message) →

Move the **JOYSTICK** to **LEFT**.



- If you press within 5 seconds from the start of playback, the previous message will be played. If you press after 5 seconds from the start of playback, the current message will be played.

◆ Skipping a Message During Playback

(During Playing
Message) →

Move the **JOYSTICK** to **RIGHT**.



◆ Stopping a Message During Playback

(During Playing Message) → Press **LEFT SOFT KEY**.







◆ Selecting the Receiver Volume During Playback

(During Playing Message) → Move the **JOYSTICK** to **UP** or **DOWN**.











◆ Clearing One Incoming/Memo Message

(During Playing Message) →

- 1 Press **JOYSTICK**.

- 2 Select "Delete".
 → 
- 3 Select "Yes", then "Deleted" is displayed.
 → 



- You can also delete the message by pressing  during playing message (p.104).

◆ Clearing All Incoming/Memo Messages

- 1 Press **JOYSTICK**.

- 2 Select "TAM Operation".
 → 
- 3 Select "Delete Message".
 → 
- 4 Select "Delete All".
 → 
- 5 Select "Yes", then "Deleted" is displayed.
 → 

◆ Calling back to the Caller

(During Playing Message) →



- 1 Press **JOYSTICK**.

- 2 Select "Call Back".
 → 

Answering System



◆ Editing a Number for Call

(During Playing Message) →

1 Press **JOYSTICK**. 

2 Select "Edit for Call".  → 



3 Edit Phone Number. (max. 24 digits)

4 Press **JOYSTICK**, **TALK** or **SPEAKERPHONE**.  OR  OR 



 1 Messages

17.8 14:59

→ If new message(s) is (are) recorded,  icon and the number of new messages will be displayed and  indicator on the base unit flashes.

◆ Playing New Incoming/Memo Message(s)

Press **PLAYBACK**. 

→ New message(s) will be played if recorded.

- If there are no new incoming/memo messages, all recorded incoming/memo messages will be played if recorded.
- If there are no recorded incoming/memo messages, "No message" will be announced.

◆ Repeating a Message During Playback

(During Playing Message) →

Press **LEFT SOFT KEY**. 

OR

Press **NAVIGATOR KEY** left. 

- If you press within 5 seconds from the start of playback, the previous message will be played. If you press after 5 seconds from the start of playback, the current message will be played.

◆ Skipping a Message During Playback

(During Playing Message) → Press **RIGHT SOFT KEY**.  OR Press **NAVIGATOR KEY** right. 

◆ Stopping a Message During Playback

(During Playing Message) → Press **STOP**.  → To return to the message playback, press **PLAYBACK**.  OR To finish the message playback, press **STOP** again. 

◆ Selecting the Receiver Volume During Playback



(During Playing Message) → To increase volume, press **NAVIGATOR KEY** up. To decrease volume, press **NAVIGATOR KEY** down. 

◆ Clearing One Incoming/Memo Message

(During Playing Message) → Press **ERASE**. 

◆ Clearing All Incoming/Memo Messages





All recorded messages, except the greeting message, can be erased at one time.

1 Press **ERASE**.  **2** Within 5 seconds after the guidance, press **ERASE**. 

Answering System



◆ Editing a Number for Call

(During Playing Message) →

- 1 Press **MIDDLE SOFT KEY**.

- 2 Select "Edit for Call".
 → 
- 3 Edit Phone Number.
(max. 24 digits)
- 4 Lift the handset or press **SPEAKERPHONE**.











◆ Calling Back to the Caller

(During Playing Message) →

- 1 Press **MIDDLE SOFT KEY**.

- 2 Select "Call Back".
 → 

◆◆ Monitor Function ON/OFF

If Monitor Function is OFF, you can listen to only the caller's message which is being recorded.

- 1 Press **JOYSTICK** (or move).

- 2 Select "TAM Operation".
 → 
- 3 Select "Setting TAM".
 → 
- 4 Select "Greet Monitor".
 → 
- 5 Select "On" or "Off".
 → 

- The factory preset is "On".

◆◆ Answering System Direct Command

You can operate the answering system by pressing dialling button as direct command.

1 Press **JOYSTICK**
(or move).























2 Select “ TAM
Operation”.



3 Select “Play New Msg.”
or “Play All Msg.”.



Follow steps 1 to 3 shown above, then:	
Press 	To repeat a message.
Press 	To skip a message.
Press 	To stop a message playback.
Press  	To delete one incoming/memo message. *1
Press  	To delete all incoming/memo message.

Follow steps 1 to 2 shown above, then:	
Press 	To enter the answering system setting menu.
Press 	To playback new incoming/memo message(s).
Press 	To playback all incoming/memo message(s).
Press 	To playback a greeting message.
Press  	To record a memo message.
Press  	To record your own greeting message.
Press 	To set the answering system ON.
Press 	To stop playing back or recording message.
Press 	To set the answering system OFF.
Press  	To delete your own recorded greeting message.

*1 This function is available only during incoming/memo message playback.

Answering System









◆◆ Remote Operation from a Touch Tone Phone

You can operate the answering system from any touch tone phone.



Firstly you must store your remote code using the handset near the base unit.

The 3-digit remote code prevents unauthorised use of your answering system for listening to recorded messages.

◆ Setting the Remote Code ON

1 Press JOYSTICK (or move). 	2 Select "TAM Operation".  → 	3 Select "Setting TAM".  → 
4 Select "Remote Code".  → 	5 Enter 3-digit Remote Code.	6 Press JOYSTICK . 

◆ Setting the Remote Code OFF

Follow steps 1 to 4 of Setting the Remote Code ON , then:	
5 Press * . 	6 Press JOYSTICK . 

- The factory preset is Remote Code OFF.

◆ Turning ON the Answering System Remotely

You can Turning on the answering system from any touch tone phone.

1 Call from a touch tone phone then wait for 20 rings.	2 Enter remote code within 10 seconds after a long beep.
3 Enter remote code after greeting message playback.	4 Voice menu starts after 3 seconds. ▶ Follow the guidance (p.112).
OR	
Enter your desired direct remote command (See next page).	

- If your remote code is not stored, you cannot turn on the answering system remotely.

◆ Summary of Remote Operation

You can operate the answering system from any touch tone phone.

1 Call from a touch tone phone.	2 Greeting message playback.	3 Enter remote code.
4 Number of new message is played.	5 Voice menu is started after 3 seconds. ▶ Follow the guidance (See next page).	
OR		
Enter your desired direct remote command (See below).		

◆ Direct Remote Commands

After entering the remote code, you can choose to operate your answering system using direct commands as below, in place of listening to the voice menu. Hang up to end the remote operation at any time.

Command	Function
1	Repeat message (during playback)
2	Skip message (during playback)
4	New message playback
5	All message playback
6	Check greeting message
7 ▶ Record	Greeting message recording
9	Stop operating
0	Answering system off
* ▶ 4	Deleting specific message (during playback)
* ▶ 5	Deleting all messages
* ▶ 6	Deleting greeting message (during playback)
* ▶ □	Disconnect

Answering System

◆ Voice Menu





The words in “ ” means a voice guidance.

	Press 1 . ➡	
	<p>“Press 1 to playback all messages. Press 2 for other functions.”</p>	<p>“All message playback.” At the end of the last message, “End of final message” is announced. When the remaining recording time becomes less than 5 minutes, the remaining recording time is announced.</p>
	<p>“Press 1 to playback new messages. Press 2 for other functions.”</p>	<p>“New message playback.”</p>
	<p>“Press 1 to record your message. Press 2 for other functions.”</p>	<p>“Please leave your message.” Talk after you hear this message.</p> <p style="text-align: center;">↓</p> <p>Hang up to finish recording.</p>
	<p>“Press 1 to erase all messages. Press 2 for other functions.”</p>	<p>“No message.”</p>
	<p>“Press 1 to record your greeting. Press 2 for other functions.”</p>	<p>“Press 7 to record your greeting. Press 9 to end recording.”</p> <p>Press 7 to start recording.</p> <p style="text-align: center;">↓</p> <p>Talk after the long beep.</p> <p style="text-align: center;">↓</p> <p>Press 9 to finish recording.</p>



- After playback, the voice menu will start again from the beginning.
- If you hear “Memory full” after playback, erase some or all of the messages (p.105).

◆◆ Recording a Memo Message



<p>1 Press JOYSTICK (or move).</p> 	<p>2 Select "TAM Operation".</p> 	<p>3 Select "Record".</p> 
<p>4 Select "Record Memo".</p> 	<p>5 Record Memo Message. 20 cm away from the Mic.</p>	<p>6 Press JOYSTICK.</p> 





<p>1 Press MIDDLE SOFT KEY.</p> 	<p>2 Select "Record Memo".</p> 	<p>3 Record Memo Message. 20 cm away from the Mic (p.8).</p>
<p>4 Press STOP.</p> 		

◆◆ Recording Your Telephone Conversation

When you record your 2-way telephone conversation, you should inform the other party that the conversation is being recorded.

During recording, a beep will sound approximately every 15 seconds.

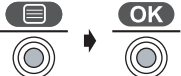
This feature is available only for cordless handset.

<p>(During a call) →</p>	<p>1 Press JOYSTICK twice to start recording, then "Recording" is displayed.</p> 	<p>2 Press JOYSTICK to stop recording.</p> 
--------------------------	--	--

Using the Belt Clip

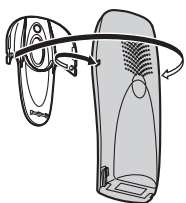

To remove the belt clip.



You can hang the cordless handset on your belt or pocket using the belt clip.

Optional Headset

Plugging an optional headset into the cordless handset allows hands-free phone conversations. Please use only the Panasonic KX-TCA89EX headset. To order, call the accessories telephone number on page 4. While using the headset, speakerphone is not available. To switch to speakerphone, disconnect the headset.

◆ Connecting the Optional Headset to the Cordless Handset

Open the headset socket cover, and connect the optional headset to the headset socket as shown.

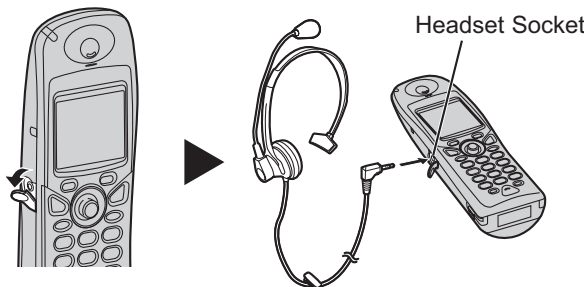

- 1 Press the tabs in the direction of the arrows (①), then remove the wall mounting adaptor (②).

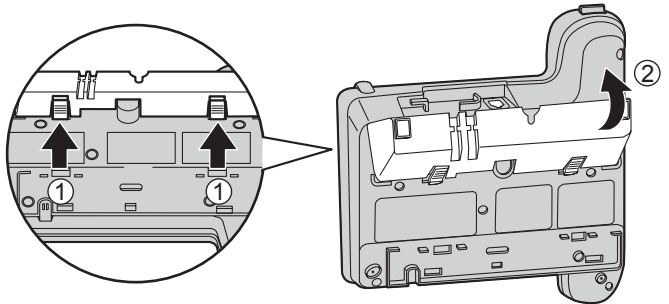

- 2 Connect the AC adaptor and the telephone line cord.

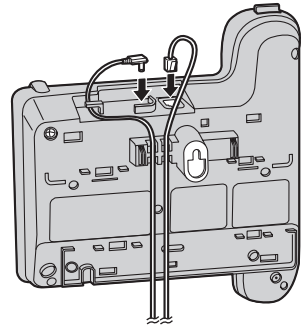

- 3 Put the wall mounting adaptor back.
 - The word "UP DESK" should be upward.

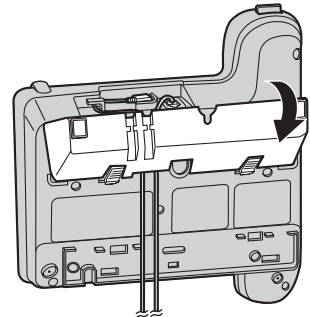

Desktop Use

- 4** Fasten the AC adaptor and the telephone line cord on the wall mounting adaptor.

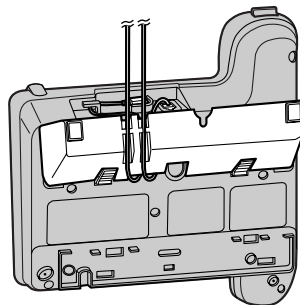

- 5** Place the base unit on the desk.

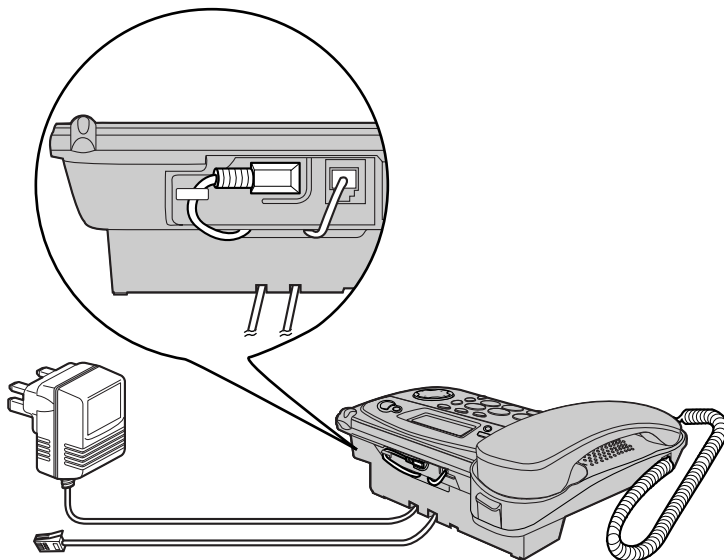

Base Unit

This base unit can be mounted on the wall.

- 1 Pull down the handset hook until it locks, so the tab holds the handset.

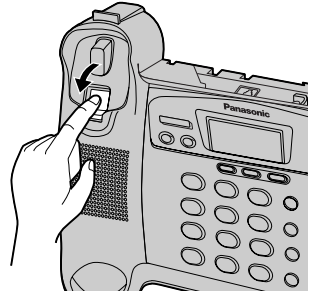

- 2 Press the tabs in the direction of the arrows (①), then remove the wall mounting adaptor (②).

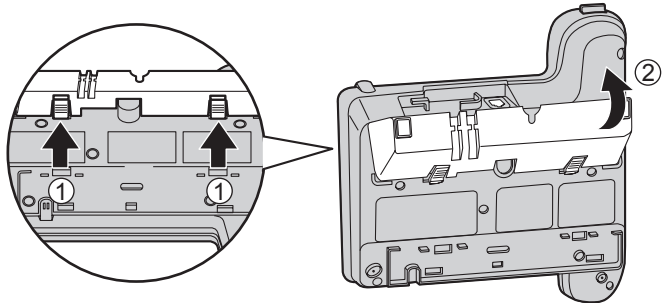

- 3 Connect the AC adaptor, then push the wall mounting adaptor in the direction of the arrows (①) and (②).
 - The word "UP WALL" should face upward.

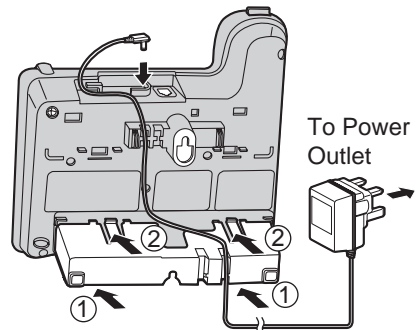

Wall Mounting

- 4 Connect the telephone line cord.
Install screws using the wall template,
then mount the base unit.

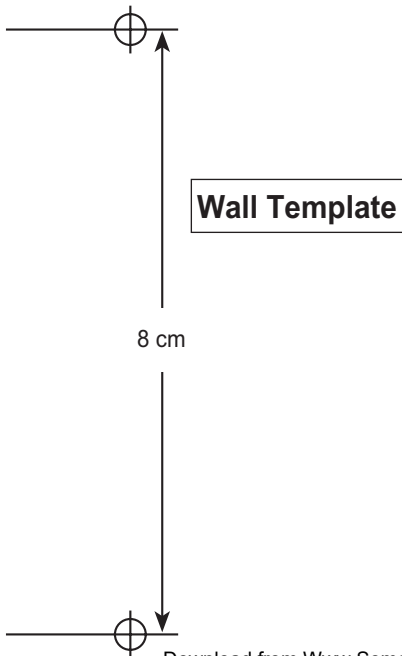
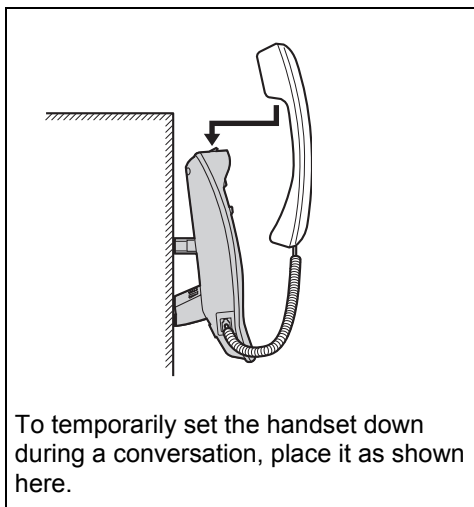
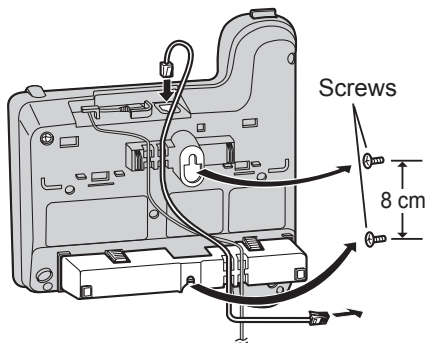

Charger unit

The charger can be mounted on the wall.

- 1 Connect the AC adaptor.

To Power Outlet

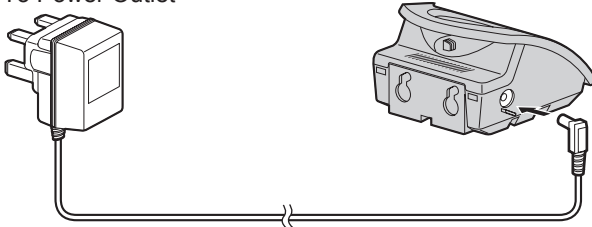

- 2 Install screws using the wall template, then mount the charger.

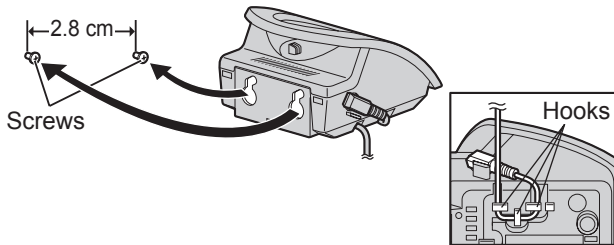

Fasten the AC adaptor cord to prevent it from being disconnected.

Wall Template

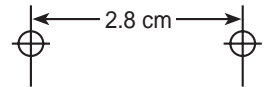

Before Requesting Help

If you experience any problems with the normal use of your apparatus, you should unplug it from the telephone outlet and connect a known working telephone in its place. If the known working telephone still has problems, then please contact the customer service department of your Network provider.

If it operates correctly, then the problem is likely to be a fault in your apparatus.

In this case, contact your supplier for advice. Your Network provider may charge you if they attend a service call that is not due to an apparatus supplied by them.



Turn the power OFF then ON (Handset)/Disconnect then connect the AC adaptor (Base Unit).

Problem	Possible cause	Solution	Page
The unit does not work.	<ul style="list-style-type: none"> Batteries not installed properly. AC adaptor of base unit not connected properly. 	<ul style="list-style-type: none"> Re-install batteries properly. Disconnect and then connect AC adaptor. 	p.15
Display is blank.	<ul style="list-style-type: none"> Cordless handset not turned on. 	<ul style="list-style-type: none"> Turn on power. 	p.18
Cordless handset will not turn on.	<ul style="list-style-type: none"> Batteries not inserted. Batteries not charged. 	<ul style="list-style-type: none"> Insert the 2 rechargeable batteries supplied. Place cordless handset on charger and connect AC adaptor to charger and AC outlet (full charge period 7 hrs). 	p.15
Battery charge icon not counting up.	<ul style="list-style-type: none"> Dirty charge contact. Charger not powered up. 	<ul style="list-style-type: none"> Clean charge/battery contact and retry charge. Connect AC adaptor to charger and AC outlet. 	p.16 p.15
📶 icon flashes.	<ul style="list-style-type: none"> Cordless handset not registered to base unit. Cordless handset out of range of base unit. No power into base unit. 	<ul style="list-style-type: none"> Register cordless handset to base unit. Move cordless handset closer to base unit. Connect AC adaptor to base unit and AC outlet. 	p.89 p.15
Cordless handset busy tone heard when  is pressed.	<ul style="list-style-type: none"> Cordless handset out of range of base unit. Another unit in use. 	<ul style="list-style-type: none"> Move cordless handset closer to base unit. Wait for the other user to complete call. 	
No dial tone.	<ul style="list-style-type: none"> Telephone line not connected. 	<ul style="list-style-type: none"> Insert telephone line cord to network. Turn power OFF then ON. 	p.15 p.18

Before Requesting Help

Problem	Possible cause	Solution	Page
Cannot dial out.	<ul style="list-style-type: none"> • Call Bar mode set. • Particular dialled number is restricted. • Key lock mode ON. 	<ul style="list-style-type: none"> • Turn feature off. • Remove number from call restricted list. • Turn key lock OFF. 	<p>p.72 p.87 p.79 p.25</p>
Cordless handset will not ring.	<ul style="list-style-type: none"> • Ringer switched off. 	<ul style="list-style-type: none"> • Set ringer to one of 6 volume levels. 	p.69
Last number redial does not work.	<ul style="list-style-type: none"> • Number exceeded 24 digits. 	<ul style="list-style-type: none"> • Redial manually. 	p.26
Audible Caller sounds late.	<ul style="list-style-type: none"> • Recording time is long. 	<ul style="list-style-type: none"> • Shorten recording time 	p.45
No Caller ID number displayed.	<ul style="list-style-type: none"> • Service not supplied. • Caller has withheld info. 	<ul style="list-style-type: none"> • Caller ID service must be arranged with Network provider. 	p.30
 icon flashes	<ul style="list-style-type: none"> • Battery low. 	<ul style="list-style-type: none"> • Recharge batteries. 	p.16
Cannot register cordless handset to base unit.	<ul style="list-style-type: none"> • Max. number of base units already registered to cordless handset. • Max. number of cordless handsets already registered to base unit. • Wrong PIN number entered (Default 0000). • Electrical noise in local area. 	<ul style="list-style-type: none"> • Delete unused base unit registrations from cordless handset. • Delete unused cordless handset registrations from base unit. • If PIN number is lost, contact the Panasonic Customer Care Helpline. • Move base unit/cordless handset away from sources of electrical noise (e.g., TVs, radios, etc.). 	<p>p.90 p.90 p.80 p.6</p>
The unit begins ringing (one ring) after other connected telephones.	<ul style="list-style-type: none"> • The SMS feature is turned on. 	<ul style="list-style-type: none"> • Turn the SMS feature off, if you do not use an SMS service. 	p.63
The display is blank even if the unit is charged.	<ul style="list-style-type: none"> • Battery low. 	<ul style="list-style-type: none"> • Recharge batteries more than about 15 minutes. 	p.16
Date and time disappeared.	<ul style="list-style-type: none"> • Power failure. 	<ul style="list-style-type: none"> • Set the date and time. 	p.20
Clock is slow (fast).	<ul style="list-style-type: none"> • Power failure. 	<ul style="list-style-type: none"> • Readjust date/time from cordless handset 1. 	p.20

Before Requesting Help

Problem	Possible cause	Solution	Page
A beep sounds when  or  on the base unit is pressed.	<ul style="list-style-type: none"> • Another unit in use. 	<ul style="list-style-type: none"> • Wait for the other user to complete the operation. 	
A beep sounds when entering caller list or base unit phonebook with cordless handset.	<ul style="list-style-type: none"> • Another unit in use. 	<ul style="list-style-type: none"> • Wait for the other user to complete the operation. 	
The unit picks up the wrong voice tag.	<ul style="list-style-type: none"> • Similar voice tag exists. 	<ul style="list-style-type: none"> • Record different voice tag. 	p.48

Answering System

Problem	Possible cause	Solution	Page
The answering system is on, but incoming messages are not recorded.	<ul style="list-style-type: none"> • The recording time is set to "Greeting Only". • Memory is full (30 minutes or 64 messages). 	<ul style="list-style-type: none"> • Select "1 Minute" or "No Limit (see "Answering System")". • Erase some or all of the messages. 	p.101 p.105 p.107
You cannot operate the answering system from a touch tone phone.	<ul style="list-style-type: none"> • Incorrect remote code entered. • Tone are too short to activate the unit. • The answering system is off. 	<ul style="list-style-type: none"> • Enter the correct remote code. • Press each button firmly. • Turn on the answering system. 	p.110 p.100 p.110
You cannot operate the answering system with the unit.	<ul style="list-style-type: none"> • Someone is operating the answering system 	<ul style="list-style-type: none"> • Retry when other user has finished operation. 	
While recording a greeting message, the unit starts to ring and stops recording.	<ul style="list-style-type: none"> • A call is being received. 	<ul style="list-style-type: none"> • Answer the call. Retry recording after conversation is finished. 	
During playback, the unit starts to ring and stops playback.	<ul style="list-style-type: none"> • A call is being received. 	<ul style="list-style-type: none"> • Answer the call. Retry playback after conversation is finished. 	

Before Requesting Help

SMS-Text Messaging

Problem	Possible cause	Solution	Page
Cannot send a message.	<ul style="list-style-type: none">• You have not subscribed to Caller ID.• SMS Centre number is not stored in your telephone.• Message was interrupted during sending.	<ul style="list-style-type: none">• Caller ID service must be arranged with Network provider.• Store the number.• Wait until the message has been sent before using any other telephone functions.	p.53 p.62
Cannot send or receive a message.	<ul style="list-style-type: none">• Memory is full.	<ul style="list-style-type: none">• Delete messages in the Outgoing/Incoming lists.	p.58 p.60

Error Code	Description	Page
FD	<ul style="list-style-type: none">• Could not connect to the SMS Centre. Check that you have the correct SMS Centre numbers or turn the SMS feature on.	p.62 p.63
FE	<ul style="list-style-type: none">• There was a problem sending the message.	
EO	<ul style="list-style-type: none">• Your number is permanently withheld or you have not subscribed to a Caller ID service.	p.52

Character Table

◆◆ Phonebook Character Table

Buttons	Alphabet (ABC)	Numeric (0-9)	Greek(ΑΒΓ)	Extended 1(AĂĀ)	Extended 2(SSŠ)	Russian (АБВ)
Ⓐ	Space # & ' () * , - . / 1	1	Space # & ' () * , - . / 1			
Ⓑ	ABC2	2	Α Β Γ 2	AĂĀĂĀĂĀĀBCÇ2	AĂĀĂBCČ2	А Б В Г 2
	abc2					
Ⓒ	DEF3	3	Δ Ε Ζ 3	DEĒĒĒĒĒĒĒF3	DĚĚĚĚĚF3	Д Е Ж З 3
	def3					
Ⓓ	GHI4	4	Η Θ Ι 4	GĜHIĪĪĪĪĪĪ4	GHIĪ4	И Й К Л 4
	ghi4					
Ⓔ	JKL5	5	Κ Λ Μ 5	JKL5	JKLĹĹĹ5	М Н О П 5
	jkl5					
Ⓜ	MNO6	6	Ν Ξ Ο 6	MNŃOŃŃŃŃŃŃŃ6	MNŃŃOŃŃŃ6	Р С Т У 6
	mno6					
Ⓝ	PQRS7	7	Π Ρ Σ 7	PQRSŞ7	PQRŘŘSŠ7	Ф Х Ц Ч 7
	pqrs7					
Ⓟ	TUV8	8	Τ Υ Φ 8	TUÚUÚŪŪV8	TŤUUŪŪŪV8	Ш Щ Ъ Ы 8
	tuv8					
Ⓡ	WXYZ9	9	Χ Ψ Ω Ξ 9	WŴXYŶZ9	WXYŶYZŽŽ9	Ъ Э Ю Я 9
	wxyz9					
Ⓢ	Space 0	0	Space 0			

- The following small (or capital) letters of Greek, Russian (Cyrillic), Polish, Czech and Slovakian are not available. Then same letter as capital (or small) will be displayed. a c e ĭ ĩ ñ ø ř š s ſ ů ŵ ỳ ŷ ž ž ž
- Press **↵** to change letter size; Capital > Small, Small > Capital.
- To enter in LetterWise® Mode, see next page. (As for **Ⓐ**, see the table on this page.)

◆◆ SMS Character Table

“LetterWise®” Character Table

Buttons	①	ABC ②	DEF ③	GHI ④	JKL ⑤	MNO ⑥	PQRS ⑦	TUV ⑧	WXYZ ⑨
Character Displayed	Space . @ / : ; * # + - 1 " ' , ! i ? ¿ _ € £ \$ ¥ () [] { } & % \ ^ ~ < > = = ¢ §	ABC 2	DEF 3	GHI 4	JKL 5	MNO 6	PQRS 7	TUV 8	WXYZ 9
		abc 2	def 3	ghi 4	jkl 5	mno 6	pqrs 7	tuv 8	wxyz 9

- Press **①** for space or 0.
- Press **(↔)** to change letter size; Capital > Small, Small > Capital.
- Press **(#)** to show the next suggested character.

“Alphabet”, “Numeric”, “Greek” and “Extended” Character Table

Buttons	Alphabet (ABC)	Numeric (0-9)	Greek (ΑΒΓ)	Extended (AÄÅ)
①	Space . @ / : ; * # + - 1 " ' , ! i ? ¿ _ € £ \$ ¥ () [] { } & % \ ^ ~ < > = = ¢ §	1	Space . @ / : ; * # + - 1 " ' , ! i ? ¿ _ € £ \$ ¥ () [] { } & % \ ^ ~ < > = = ¢ §	Space . @ / : ; * # + - 1 " ' , ! i ? ¿ _ € £ \$ ¥ () [] { } & % \ ^ ~ < > = = ¢ §
ABC ②	ABC 2 abc 2	2	ΑΒΓ 2	A Ä Å Ã Ä Å Æ Β Γ Ç 2 a ä å ã ä å æ β γ ç 2
DEF ③	DEF 3 def 3	3	Δ Ε Ζ 3	Δ Ε Ę Ę Ę Ę Ę Ę F 3 d e è é ê ë ě f 3
GHI ④	GHI 4 ghi 4	4	Η Θ Ι 4	G Ğ Η Ι Í Î Ï Ï Ï 4 g ğ h i í î ï ï ï 4
JKL ⑤	JKL 5 jkl 5	5	Κ Λ Μ 5	JKL 5 j k l 5
MNO ⑥	MNO 6 mno 6	6	Ν Ξ Ο 6	M Ñ Ñ Ñ Ñ Ñ Ñ Ñ Ñ Ñ 6 m n ñ ò ó ô õ ö ø 6
PQRS ⑦	PQRS 7 pqrs 7	7	Π Ρ Σ 7	P Q R S Ş ß 7 p q r s ş ß 7
TUV ⑧	TUV 8 tuv 8	8	Τ Υ Φ 8	T U Ú Ú Ú Ú Ú Ú V 8 t u ú ú ú ú ú v 8
WXYZ ⑨	WXYZ 9 wxyz 9	9	Χ Ψ Ω 9	W X Y Z 9 w x y z 9
①	Space 0	0	Space 0	Space 0

- The following small (or capital) are not available. The same letter as capital (or small) will be displayed.
ø §
- Press **(↔)** to change letter size; Capital > Small, Small > Capital.

Index

AC Adaptor	5, 15
Accessories	5
Answering a Call	22
Answering System	100
Any Key Talk	22
Audible Caller ID	36
Auto Talk	22, 75
Base Unit	
Display	14
Operations	82
PIN	80
Reset	80
Ringer Pattern	86
Ringer Volume	86
Selection	91
Base Unit Phonebook	
Deleting	45
Dialling	43
Editing	44
Storing	38
Battery	
Caution	6
Charge	16
Information	16
Installation	15
Call Bar	72, 87
Call Restriction	79
Call Waiting	29
Caller ID List Menu (Base Unit)	
Deleting	83
Editing	83
Caller ID List Menu (Cordless Handset)	
Deleting	33
Editing	33
Storing	32
Cancelling a Base Unit	90
Cancelling a Cordless Handset	90
Chain Dial	47
Conference Call	94, 95, 96
Cordless Handset	
Display	13
PIN	74
Registration	89
Reset	76
Ringer Pattern	69
Ringer Volume	69
Date and Time	20
Dialling Pause	28, 78
Direct Call Number	72
Display	
Standby Mode	70
Talk Mode	71
Emergency Calls	78
Flash/Earth	77
Guarantee	128
Handset phonebook	
Dialling	43
Hot Keys	46
Storing	37
Hands-Free Phone	
Base Unit	24
Cordless Handset	23
Intercom Between Registered Units	92
Key	
Lock	25
Tone	70
Making a Call	21
Memo Alarm	66
Memo Message	104, 113
Mute	24
Phonebook	
Copy	50
Storing	37, 38
Power ON/OFF	18
Private Category	36
Recall	27, 77
Receiver Volume	23
Recording Telephone Conversation	113
Redial List Menu (Base Unit)	
Deleting	84
Editing	84
Redial List Menu (Cordless Handset)	
Deleting	35
Editing	35
Storing	34
Redialling	26
Setting up	15
SMS Feature	52
Specifications	127
Transferring a Call	94
Voice Search	48
Walkie-Talkie	97

Specifications

Standard:	DECT=(<u>D</u> igital <u>E</u> nhanced <u>C</u> ordless <u>T</u> elecommunications) GAP=(<u>G</u> eneric <u>A</u> ccess <u>P</u> rofile)
Number of channels:	120 Duplex Channels
Frequency range:	1.88 GHz to 1.9 GHz
Duplex procedure:	TDMA (Time Division Multiple Access)
Channel spacing:	1728 kHz
Bit rate:	1152 kbit/s
Modulation:	GFSK
RF Transmission Power:	approx. 250 mW
Voice coding:	ADPCM 32 kbit/s
Power source:	(For Base Unit) AC Adaptor 220 - 240 V, 50 Hz (For Charger Unit) AC Adaptor 220 - 240 V, 50 Hz
Power consumption:	(For Base Unit) Standby: Approx. 2.6 W Maximum: Approx. 9.2 W (For Charger Unit) Standby: Approx. 2.3 W Maximum: Approx. 6.8 W
Operating conditions:	5 - 40 °C, 20 - 80 % relative air humidity (dry)
Dimensions, Base Unit:	About (53 mm x 205 mm x 197 mm) x 670 g
Dimensions, Cordless Handset:	About (143 mm x 48 mm x 32 mm) x 125 g
Dimensions, Charger:	About (60 mm x 86 mm x 84 mm) x 113 g

- Specifications are subject to change.
- The illustrations used in this manual may differ slightly from the original device.

“Eatoni and LetterWise are trademarks of Eatoni Ergonomics, Inc.”

Guarantee

CONDITIONS OF GUARANTEE

This guarantee is in addition to and does not in any way affect any statutory or other rights of consumer purchasers. If within the applicable guarantee period, the appliance proves to be defective by reason of faulty design, workmanship or materials, we undertake subject to the following conditions to have the defective appliance (or any part or parts there of) repaired or replaced free of charge.

1. The appliance shall have been purchased and used solely within either the UK or ROI and in accordance with standard operating instructions and the technical and/or Safety Standards required in the UK.
2. The appliance should be returned together with this guarantee and proof of date of purchase promptly on being found defective at the purchaser's risk and expense to the authorised dealer from whom the appliance was purchased or to the nearest authorised dealer. All enquires must be through such dealers.
3. This guarantee shall not apply to damage caused through fire, accident, lightning, misuse, wear and tear, neglect, incorrect adjustment or repair, to damage caused through installation, adaption, modification or use in an improper manner or inconsistent with the technical and/or safety standards required in the country where this appliance is used, or to damage occurred during transit to or from the purchaser.
4. If at any time during the guarantee period any part or parts of the appliance are replaced with a part or parts not supplied or approved by us or of an objective quality safe and suitable for the appliance, or the appliance has been dismantled or repaired by any person not authorised by us, we shall have the right to terminate this guarantee in whole or in part immediately without further notice.
5. The purchaser's sole and exclusive remedy under this guarantee against us is for the repair or replacement of the appliance or any defective part or parts and no other remedy, including, but not limited to, incidental or consequential damage or loss of whatsoever nature shall be available to the purchaser.
6. This guarantee shall not apply to batteries and any other items of limited natural life.
7. Our decision on all matters relating to complaints shall be final. Any appliance or defective part which has been replaced shall become our property.
8. The guarantee period applicable to this product shall be 12 months.

Please keep these Operating Instructions with your receipt.

Panasonic Business Systems U.K.

Receipt No.

Date of Purchase

Model No. KX-TCD545E

Serial No.

Hereby, Panasonic Communications Co., Ltd., declares that this Dect Cordless Telephone is in compliance with the essential requirements and other relevant provisions of Directive 1999/5/EC.

A copy of the manufacturer's declaration of conformity to the essential requirements of the R&TTE Directive is available at the following web address:

<http://doc.panasonic-tc.de>

For your future reference

Serial No.

Date of purchase

(found on the bottom of the unit)

Name and address of dealer

Attach or keep original receipt to assist with any repair under warranty.

Customer Care Helpline Tel. No. : U.K. 08700 100 076
R.O.I. 01289 8333

CE0436

1999/5/EC

This equipment is designed for use in the United Kingdom only.

In the event of problem, you should contact your equipment supplier in the first instance.

Technical specifications are subject to change.

Sales Department:

Panasonic Business Systems U.K.

Panasonic House, Willoughby Road, Bracknell, Berkshire, RG12 8FP

Panasonic Communications Co., Ltd.

1-62, 4-chome, Minoshima, Hakata-ku, Fukuoka 812-8531, Japan

Free Manuals Download Website

<http://myh66.com>

<http://usermanuals.us>

<http://www.somanuals.com>

<http://www.4manuals.cc>

<http://www.manual-lib.com>

<http://www.404manual.com>

<http://www.luxmanual.com>

<http://aubethermostatmanual.com>

Golf course search by state

<http://golfingnear.com>

Email search by domain

<http://emailbydomain.com>

Auto manuals search

<http://auto.somanuals.com>

TV manuals search

<http://tv.somanuals.com>