

Panasonic

2.4GHz Digital Cordless Answering System

Operating Instructions

Model No. **KX-TG2224F**
KX-TG2224P
KX-TG2224W

Pulse-or-tone dialing capability



KX-TG2224W

Caller ID Compatible

PLEASE READ BEFORE USE AND SAVE.

Charge the battery for about 6 hours before initial use.

Panasonic World Wide Web address: <http://www.panasonic.com>
for customers in the USA or Puerto Rico

Preparation

Cordless Telephone

Answering System

Useful Information

Thank you for purchasing your new Panasonic cordless telephone.

Please read **IMPORTANT SAFETY INSTRUCTIONS** on page 59 before use. Read and understand all instructions.

Caller ID and Call Waiting Service, where available, are telephone company services. After subscribing to Caller ID, this phone will display a caller's name and phone number. Call Waiting Caller ID, which displays a second caller's name and phone number while the user is on another call, requires a subscription to both Caller ID and Call Waiting.

Attach your purchase receipt here.

Energy Star:



- As an ENERGY STAR® Partner, Panasonic has determined that this product meets the ENERGY STAR guidelines for energy efficiency. ENERGY STAR is a U.S. registered mark.



Trademarks:

openLCR, openLCR.com, and the openLCR logo are the trademarks of openLCR.com, Inc.

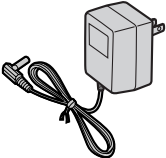
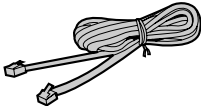
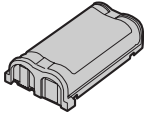
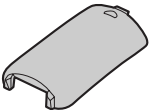
Accessories (included) For extra orders, call 1-800-332-5368.

<input type="checkbox"/> AC Adaptor (p. 8) Order No. PQLV19Z (PQLV19)  one	<input type="checkbox"/> Telephone Line Cord (p. 8) Order No. PQJA10075Z  one	<input type="checkbox"/> Battery (p. 8) Order No. HHR-P513  one
<input type="checkbox"/> Handset Cover (p. 8) Order No. PQKK10136Z1 (White) PQKK10136Z3 (Blue) PQKK10136Z4 (Taupe)  one	<input type="checkbox"/> Belt Clip (p. 48) Order No. PQKE10361Z1 (White) PQKE10361Z2 (Blue, Taupe)  one	<input type="checkbox"/> Shoulder Rest Attachment (p. 49) Order No. PQKE10364Z1  one

For Best Performance

Battery Charge

A rechargeable Nickel-Metal Hydride (Ni-MH) battery powers the handset. Charge the battery for about **6 hours** before initial use (p. 8).



Base Unit Location/Noise

Calls are transmitted between the base unit and the handset using wireless radio waves. **For maximum distance and noise-free operation**, the recommended base unit location is:

Away from electrical appliances such as a TV, personal computer or another cordless phone.

In a **HIGH and CENTRAL** location with no obstructions such as walls.

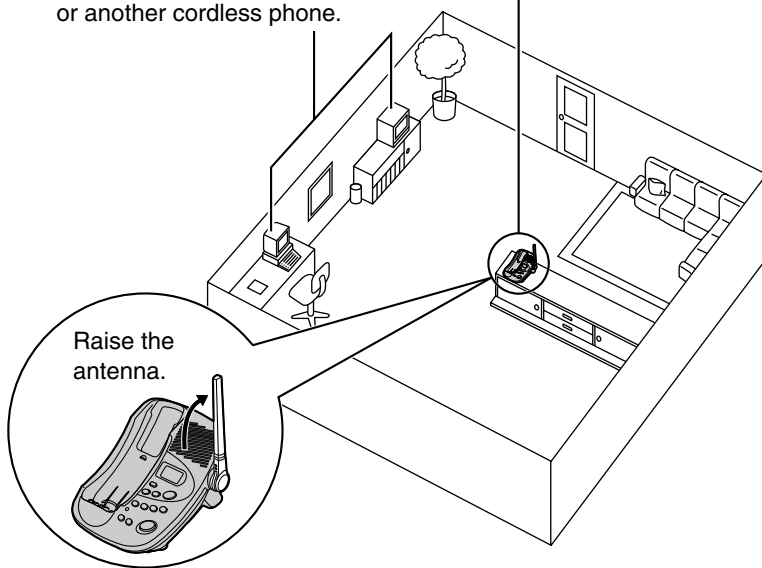

Note:

- If you use the handset near a microwave oven which is being used, noise may be heard from the receiver or the speaker. Move away from the microwave oven and closer to the base unit.
- If you use the handset near another cordless phone, noise may be heard. Move away from the other cordless phone and closer to your base unit.

Contents

Preparation

Location of Controls	6
Settings	8
Connections	8
Installing the Battery in the Handset	8
Battery Charge	8
Programmable Functions	10
Programming Guidelines	10
Function Menu Table	11
Date and Time	12
Display Language	13
Dialing Mode	14
Voice Enhancer Technology	14
Auto Talk	15
LCD Contrast	16
Ringer Volume	17
Ringer Tone	18
Line Mode	18
Preparing the Answering System	19
Greeting Message	19
Caller's Recording Time	20
Number of Rings	21

Cordless Telephone

Making Calls	22
Answering Calls	25
Caller ID Service	26
Using the Caller List	27
Viewing the Caller List	27
Calling Back from the Caller List	28
Editing the Caller's Phone Number	29
Caller ID Number Auto Edit Feature	30
Storing Caller Information in the Phone Book	31
Erasing Caller Information	32
Phone Book	33
Storing Names and Numbers	33
Dialing from the Phone Book	35
Editing an Item in the Phone Book	36
Erasing an Item in the Phone Book	36
Intercom	37
Special Features	38
Automatic Security Code Setting	38

Temporary Tone Dialing (For Rotary or Pulse Service Users)	38
Muting Your Conversation	38
For Call Waiting Service Users	38
Using the PAUSE Key (For PBX Line/Long Distance Calls)	39
FLASH Button	39

Answering System

Automatic Answering Operation	40
Setting the Unit to Answer Calls	40
Listening to Messages	41
Using the Base Unit	41
Using the Handset (Remote Operation)	42
Erasing Messages	44
Remote Operation from a Touch Tone Phone	45
Remote Code	45
Voice Menu	46
Direct Remote Operation	47

Useful Information

Wall Mounting	48
Belt Clip	48
Shoulder Rest Attachment	49
Optional Headset	49
Direct Commands	50
Troubleshooting	51
openLCR Service for Caller IQ Feature	55
Setting Caller IQ to OFF and ON	55
Downloading Phone Book Data	56
Information Download	57
Important Safety Instructions	59
FCC and Other Information	61
Specifications	64
Warranty	65
Index	67

Important:

Throughout these Operating Instructions, **Handset** and **Base Unit** are used to indicate with which unit an operation can be performed.

Handset : Perform with the handset.

Base Unit : Perform with the base unit.

Handset Base Unit : Perform with the handset and the base unit separately.

Location of Controls

Base unit

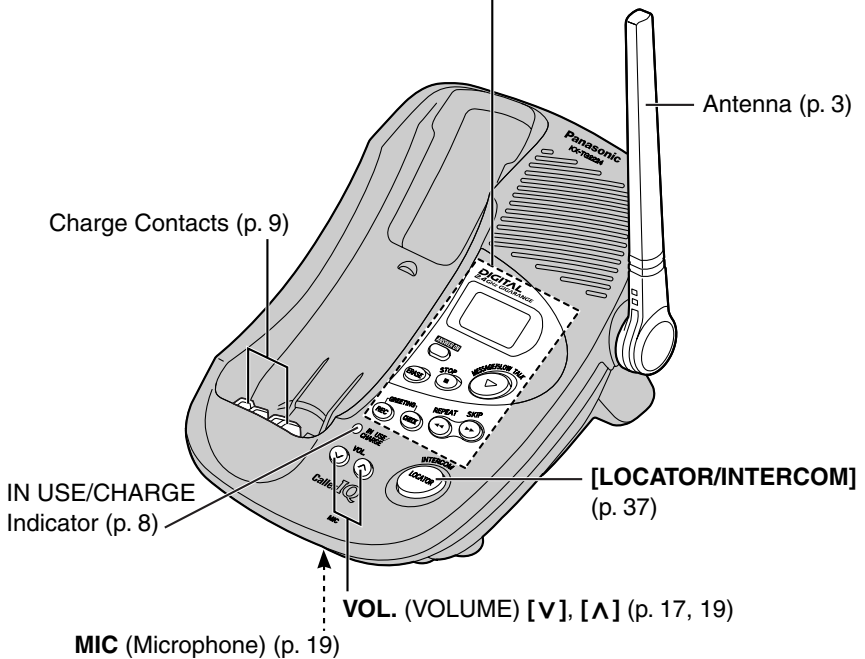
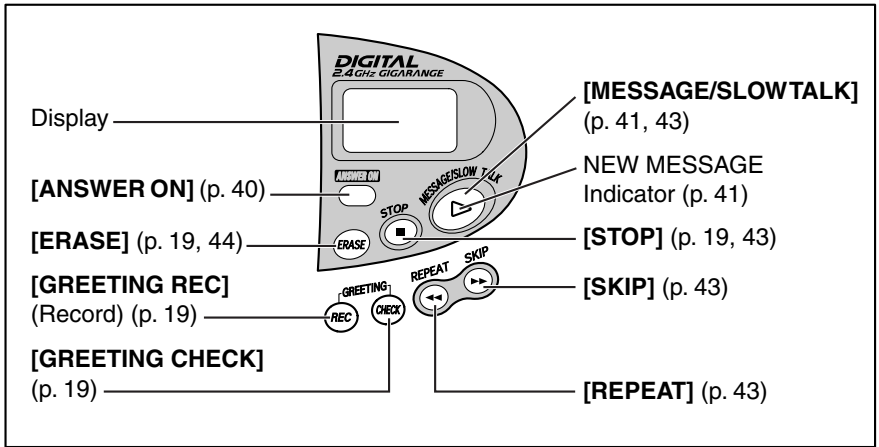

Handset

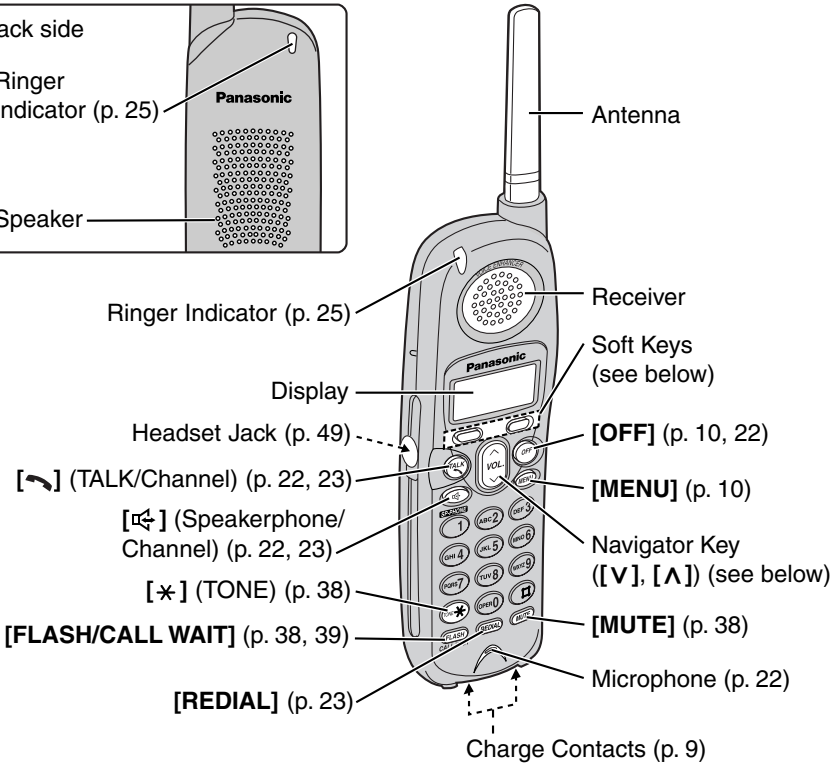
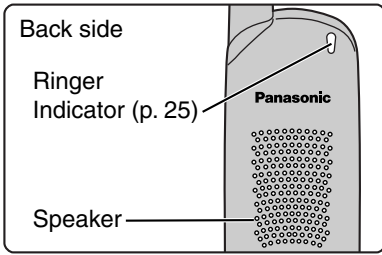

How to use the soft keys/navigator key

① Soft keys:

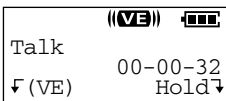

Two soft keys are used to select functions displayed directly above the keys. Functions displayed above the keys will change depending on the state of use.

For example, to operate “Hold”, press the right soft key.

- When a function does not appear above a soft key, the soft key will not work.

② Navigator key:



Scrolls through the function menu, the Caller List and the phone book (works as a scroll key).
Adjusts the handset ringer and receiver/speaker volumes (works as a volume key).

Throughout these Operating Instructions:

- The soft keys are indicated with the display above the keys.
Ex. “Press Hold.” indicates “Press the soft key below Hold”.
- The navigator key is indicated by the arrows [V] or [A].

Settings

Connections

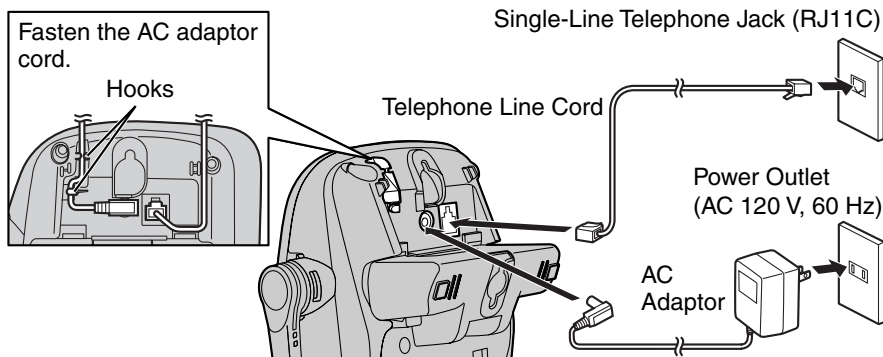

- USE ONLY WITH Panasonic AC ADAPTOR PQLV19 (Order No. PQLV19Z).
- The AC adaptor must remain connected at all times. (It is normal for the adaptor to feel warm during use.)
- If your unit is connected to a PBX which does not support Caller ID, you cannot access Caller ID services.
- The unit will not work during a power failure. To connect a standard telephone on the same line, use the Panasonic T-adaptor KX-J66.

Installing the Battery in the Handset

Insert the battery (①), and press it down until it snaps into the compartment (②). Close the cover.

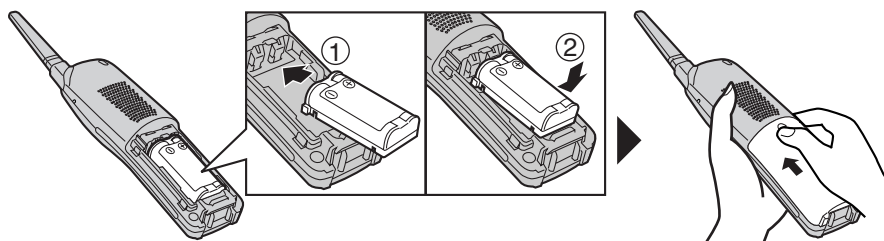

To replace the battery:

Press the notch on the cover firmly and slide it as indicated by the arrow. Replace the old battery with a new one (p. 9). Close the cover and charge the battery for about 6 hours.



Battery Charge



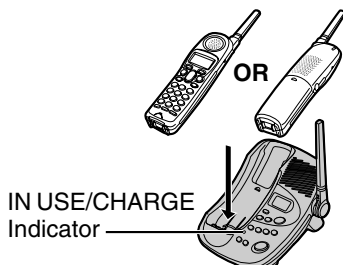

Place the handset on the base unit and charge for about **6 hours** before initial use.

- The IN USE/CHARGE indicator lights and the unit beeps once.
- It is normal for the back on the handset to feel warm during battery charge.



Battery strength

You can check the battery strength on the handset display. The battery strength is as shown in the chart on the right.

Display prompt	Battery strength
	Fully charged
	Medium
	Low
 (flashing)	Needs to be recharged.

Recharge

Recharge the battery when:

- “Recharge battery” is displayed on the handset,
- “” flashes, or
- the handset beeps intermittently while it is in use.

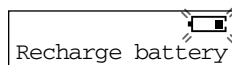

- If you DO NOT recharge the handset battery for more than 15 minutes, the display will continually indicate “Recharge battery” and/or “” will flash when the handset is lifted off the base unit.

Battery replacement:

If you cleaned the charge contacts and fully charged the battery, but after a few telephone calls, “Recharge battery” is displayed and/or “” continues to flash, the battery needs to be replaced. Please order a new Panasonic HHR-P513 battery at the telephone number shown on page 2. To replace the battery, see page 8.

A nickel metal hydride battery that is recyclable powers the product you have purchased. Please call 1-800-8-BATTERY for information on how to recycle this battery.



Battery information

After your Panasonic battery is fully charged:

Operation	Operating time
While in use (TALK)	Up to 5 hours
While not in use (Standby)	Up to 11 days

- The battery operating time may be shortened depending on usage conditions and ambient temperature.
- **Clean the charge contacts of the handset and the base unit with a soft, dry cloth once a month. Clean more often if the unit is subject to grease, dust or high humidity.** Otherwise the battery may not charge properly.
- If the battery is fully charged, you do not have to place the handset on the base unit until “Recharge battery” is displayed and/or “” flashes. This will maximize the battery life.
- The battery cannot be overcharged.

Programmable Functions

Programming Guidelines Handset

This unit has programmable functions. They are selected from the function menu on the display (p. 11).

Buttons/Keys

Soft keys : work as function keys when a function is displayed above a soft key.

When “V” or “^” is displayed, you can use the navigator key [V] or [^] as a scroll key.

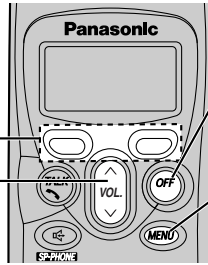

[OFF] : allows you to exit programming mode any time.

[MENU] : allows you to enter the menu by pressing while the handset is not being used.

How to select a function item from the menu

Make sure the unit is not being used and the handset is lifted off the base unit before programming.

Operation	Display
<p>1 Press [MENU] to enter menu mode.</p> <ul style="list-style-type: none"> The main menu is displayed (p. 11). 	
<p>2 Scroll to the desired item by pressing [V] or [^].</p> <ul style="list-style-type: none"> How to use the Exit key: Press Exit to exit programming mode. 	<div style="border: 1px solid #ccc; padding: 5px; width: fit-content; margin: auto;"> Initial setting ↓Exit ^ Select↓ </div>
<p>3 Press Select at your desired menu.</p>	<div style="border: 1px solid #ccc; padding: 5px; width: fit-content; margin: auto;"> ↓Exit ^ Select↓ </div>
<p>4 If your selected menu has a sub-menu, it will be displayed. Repeat steps 2 and 3 until your desired menu is displayed.</p>	
<p>5 Select your desired setting by pressing [V] or [^].</p> <ul style="list-style-type: none"> How to use the Back key: Press Back to go back to the previous menu. 	<div style="border: 1px solid #ccc; padding: 5px; width: fit-content; margin: auto;"> ↓Back ^ Save↓ </div>
<p>6 Press save to save your setting.</p> <ul style="list-style-type: none"> A confirmation tone will be heard and the setting will be saved. 	
<p>7 Press [OFF] to exit programming mode.</p>	

Useful information:

- If **Select** is pressed while “--- (Go back) ---” is displayed, the unit will go back to the previous menu mode. If you press the key in the main menu, the unit will exit programming mode.
- After programming is complete, the display will return to the main menu or the sub-menu depending on which menu the selected item is located. (See the menu table below.)
- You can exit programming mode any time by pressing [**OFF**].
- If you do not press any buttons for 60 seconds, the handset will exit programming mode.
- If the handset has lost communication with the base unit, the handset beeps 3 times and “No link to base. Place on cradle and try again.” is displayed.
- If [**↶**], [**↷**] or any other buttons except [**MUTE**] and [**OFF**] is pressed while the handset is on the base unit, the handset beeps 3 times and “Please lift up and try again.” is displayed. Lift the handset and press the button again.

Function Menu Table

You can use the following functions to customize your unit. See the corresponding pages for function details.

- After pressing [**MENU**], you can also program menu items by direct commands ([**0**] to [**9**]) instead of using the soft keys (p. 50).

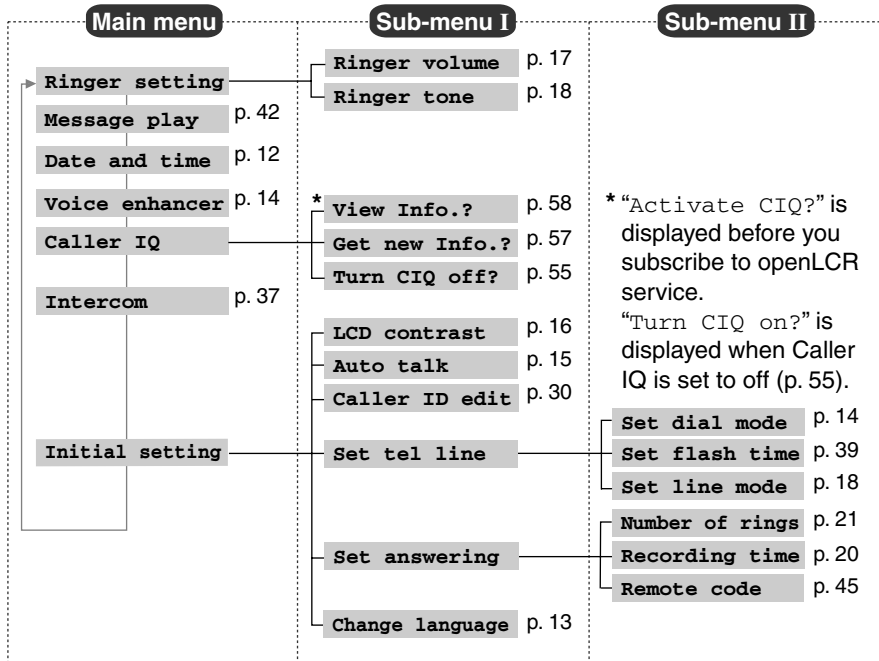

Programmable Functions

Date and Time Handset

“☉” flashes on the base unit display if the clock has not been set.
Set the clock by following the steps below.

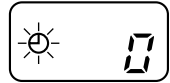

1 Press **[MENU]**.

2 Scroll to “Date and time” by pressing **[V]** or **[^]**, then press **Select**.

Date and time
↓Exit V^ Select↓

3 ① Enter 2 digits each for month, day and year.
(Ex. To set Apr. 7, 2003, enter “04 07 03”.)

Date:12.31.2003
Time:12:00 AM
↓AM/PM Save↓

② Enter 4 digits for time (hour and minute).
(Ex. To set 9:30, enter “0930”.)

- If you enter a wrong number, press **[V]** or **[^]** to move the cursor to the incorrect number. Enter the correct number.

Example

Date:04.07.2003
Time:09:30 AM
↓AM/PM Save↓

4 Select “AM” or “PM” by pressing **AM/PM**.

Date:04.07.2003
Time:09:30 AM
↓AM/PM Save↓

5 Press **save**, then press **[OFF]**.

- The clock is set and “☉” disappears from the base unit display.
- If 3 beeps sound after pressing **save**, the setting is not correct. Start again from step 3.

• When entering the time in step 3, you cannot enter numbers greater than 12.
Do not use military time. (To set 13:00 hours, enter “0100”, then select “PM” in step 4.)

If a power failure occurs, the time setting may be incorrect. When “☉” flashes on the base unit display, adjust the date/time.

Programmable Functions

To check the date/time, repeat steps 1 and 2 on page 12.

- The current date/time is displayed. When finished, press [OFF].

For Caller ID service users (p. 26)

- Caller ID information will reset the clock after the first ring if the adjusted time is incorrect.
- If the time has not previously been set, Caller ID information will not adjust the clock.
- Caller ID information will automatically adjust the clock for daylight saving time.

Display Language Handset

You can select either ENGLISH or SPANISH as the display language. The factory preset is ENGLISH.

1 Press [MENU].

2 Scroll to "Initial setting" by pressing [V] or [^], then press **Select**.

Initial setting
↓Exit V^ Select↓

3 Scroll to "Change language" by pressing [V] or [^], then press **Select**.

Change language
↓Back V^ Select↓

4 Select the language by pressing **Español** or **English**.

Change language
:English
↓Español Save↓

5 Press **Guard.** or **Save**, then press [OFF].

Programmable Functions

Dialing Mode Handset

If you have touch tone service, set to "Tone". If rotary or pulse service is used, set dialing mode to "Pulse". The factory preset is "Tone".

1 Press **[MENU]**.

2 Scroll to "Initial setting" by pressing **[V]** or **[Λ]**, then press **Select**.

Initial setting
↓Exit VΛ Select↓

3 Scroll to "Set tel line" by pressing **[V]** or **[Λ]**, then press **Select**.

Set tel line
↓Back VΛ Select↓

4 Press **Select** at "Set dial mode".

Set dial mode
↓Back VΛ Select↓

5 Select "Pulse" or "Tone" by pressing **[V]** or **[Λ]**.

Set dial mode :Tone
↓Back VΛ Save↓

6 Press **save**, then press **[OFF]**.

Voice Enhancer Technology Handset

Voice Enhancer Technology (**VEB**) helps clarify and improve sound reception creating a natural-sounding voice that is easy to hear and understand.

This is accomplished by enhancing the frequency that is narrowed through the telephone line and comes pre-set to OFF at the factory.

Under normal conditions, cordless phones are limited to a narrowed frequency bandwidth (300Hz to 3.5KHz). Panasonic's new Voice Enhancer Technology cordless phones are able to simulate a band signal above and below the normal bandwidth limitations. As a result, a clearer, crisp sound much closer to the actual voice is achieved.

• "**VEB**" is displayed when the Voice Enhancer Technology is set to ON.

1 Press **[MENU]**.

2 Scroll to "Voice enhancer" by pressing **[V]** or **[Λ]**, then press **Select**.

Voice enhancer
↓Exit VΛ Select↓

3 Select "On" or "Off" by pressing **[V]** or **[Λ]**.

Voice enhancer :Off
↓Back VΛ Save↓

4 Press **save**, then press **[OFF]**.

Helpful hint:

Depending on the condition and quality of your telephone line, Voice Enhancer may emphasize the noise already on the line. If it becomes difficult to hear the caller, please set Voice Enhancer mode to OFF.

To turn the mode ON while talking, press **(VE)**.

- “**((VE))**” is displayed.
- Each time you press **(VE)**, the mode will change to ON or OFF.

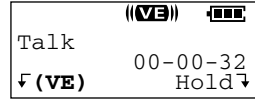

Auto Talk Handset

The Auto Talk feature allows you to answer a call by lifting the handset off the base unit without pressing **[*]** or **[*]**. To use this feature, turn the feature ON. The factory preset is OFF.

1 Press **[MENU]**.

2 Scroll to “Initial setting” by pressing **[V]** or **[^]**, then press **Select**.



3 Scroll to “Auto talk” by pressing **[V]** or **[^]**, then press **Select**.



4 Select “On” or “Off” by pressing **[V]** or **[^]**.



5 Press **save**, then press **[OFF]**.

- In order to view Caller ID information after you lift up the handset to answer a call, leave the Auto Talk feature OFF.

Programmable Functions

LCD Contrast Handset

You can select the handset LCD contrast (5 levels). The factory preset is level 3.

1 Press **[MENU]**.

2 Scroll to “Initial setting” by pressing **[V]** or **[^]**, then press **Select**.



Initial setting
↓Exit v^ Select↓

3 Press **Select** at “LCD contrast”.



LCD contrast
↓Back v^ Select↓

4 Select the desired contrast by pressing **[V]** or **[^]**.

- Each time you press **[V]** or **[^]**, the LCD contrast will change.



LCD contrast
Low ■■■ High
↓Back v^ Save↓

5 Press **save**, then press **[OFF]**.

Ringer Volume

You can select the handset or base unit ringer volume HIGH, MEDIUM, LOW or OFF. The factory preset is HIGH. If set to OFF, the handset or base unit will not ring.

Handset

1 Press **[MENU]**.

2 Press **select** at "Ringer setting".

```
Ringer setting
┆Exit  ∨∧  Select┆
```

3 Press **select** at "Ringer volume".

```
Ringer volume
┆Back  ∨∧  Select┆
```

4 Select the desired volume level by pressing **[V]** or **[∧]**.

- The volume will change and ring.
- The number of steps indicates the volume level.
- **To turn the ringer OFF**, press **[V]** repeatedly until "Ringer off" is displayed.

Ex. HIGH

```
Ringer volume
Low  ████████  High
┆Back  ∨∧  Save┆
```

5 Press **save**, then press **[OFF]**.

- If set to OFF, the handset displays "Ringer off" while not in use. But if there are missed calls and the handset is off the base unit, the handset will not display "Ringer off".
- You can select the ringer volume while an external call is being received. Press **[V]** or **[∧]** while the handset is just ringing. To set to OFF, press and hold **[V]** until "Ringer off" is displayed.

Base Unit

Make sure the base unit is not being used.

To select HIGH (preset), MEDIUM or LOW, press **VOL. [V]** or **[∧]**.

- To increase volume, press **VOL. [∧]**. To decrease volume, press **VOL. [V]**.

To turn the ringer OFF, press and hold **VOL. [V]** until 2 beeps sound.

To turn the ringer ON, press **VOL. [V]** or **[∧]**.

- The ringer will sound at the LOW level.
- You can select the ringer volume while an external call is being received. Press **VOL. [V]** or **[∧]** while the base unit is just ringing. To set to OFF, press and hold **VOL. [V]** until "**RINGER OFF**" is displayed.

Programmable Functions

Ringer Tone Handset

You can select one of 6 ringer tones for external calls on the handset and the base unit. The factory preset is 1.

1 Press **[MENU]**.

2 Press **Select** at “Ringer setting”.

Ringer setting
↓Exit V∧ **Select**↓

3 Scroll to “Ringer tone” by pressing **[V]** or **[∧]**, then press **Select**.

Ringer tone
↓Back V∧ **Select**↓

4 Select the desired tone by pressing **[V]** or **[∧]**.

- If the handset ringer volume has been set to OFF, the unit will not ring (p. 17).
- You can also select a ringer tone by pressing dialing buttons **[1]** to **[6]**.

Ringer tone :1
↓Back V∧ **Save**↓

5 Press **save**, then press **[OFF]**.

Line Mode Handset

The line mode is preset at the factory to “B”. Generally leave the line mode “B”. If a change of the line mode setting is required by our customer call center or service person, change the line mode to “A”.

1 Press **[MENU]**.

2 Scroll to “Initial setting” by pressing **[V]** or **[∧]**, then press **Select**.

Initial setting
↓Exit V∧ **Select**↓

3 Scroll to “Set tel line” by pressing **[V]** or **[∧]**, then press **Select**.

Set tel line
↓Back V∧ **Select**↓

4 Scroll to “Set line mode” by pressing **[V]** or **[∧]**, then press **Select**.

Set line mode
↓Back V∧ **Select**↓

5 Select “A” or “B” by pressing **[V]** or **[∧]**.

Set line mode :B
↓Back V∧ **Save**↓

6 Press **save**, then press **[OFF]**.

Preparing the Answering System

Greeting Message Base Unit

You can record a personal greeting message of **up to 2 minutes**. If you do not record your own message, one of two pre-recorded greetings will be played for callers (p. 20).

The total recording time of all messages (greeting, incoming, etc.) is **about 15 minutes**.

We recommend you record a **brief greeting message** in order to leave more time for recording new messages.

To record a greeting message

Sample greeting message

"Hello, this is (your name and/or number). Sorry I cannot take your call. Please leave a message after the beep. Thank you."

1 Press **[GREETING REC]**.

- "To record greeting, press RECORD again" is heard.

2 Within 10 seconds, press **[GREETING REC]** again to record your greeting.

3 After the long beep, talk clearly, about 20 cm (8 inches) away from the **MIC** (microphone).

- The elapsed recording time is displayed.
- If you record for over 2 minutes, the unit will stop recording.

4 When finished, press **[GREETING REC]** or **[STOP]**.

- To change the greeting, start again from step 1.

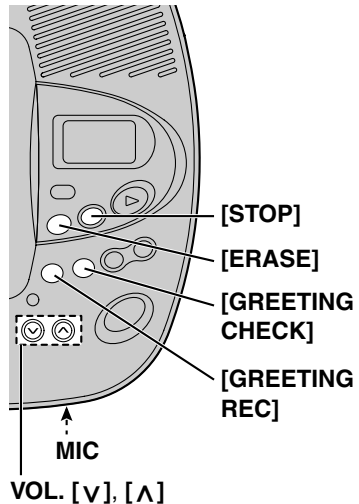

- If "E" is shown on the base unit display and 6 beeps sound, your greeting is not recorded correctly. Record it again.

To adjust the speaker volume, press **VOL. [V]** or **[^]**.

Ex. Level 8

- 9 levels (0–8) are available while using the Answering System.

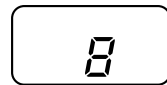

To check the greeting

Press **[GREETING CHECK]**.

- The greeting will be played.

To erase the greeting

Press **[GREETING CHECK]**, then press **[ERASE]** while the recorded message is being played.

- The unit will answer calls with a pre-recorded greeting (p. 20).

Preparing the Answering System

Pre-recorded greeting

If you do not record a greeting (p. 19), one of two greetings will be played when a call is received, depending on the caller's recording time (see below).

To check the pre-recorded greeting, press [GREETING CHECK].

- A pre-recorded greeting will be played as follows:
 - When the recording time is set to "1 minute", "2 minutes" or "3 minutes":
"Hello, we are not available now. Please leave your name and phone number after the beep. We will return your call."
 - If recording time runs out, the unit will automatically switch to the "Greeting only" mode (see below), and no new messages will be recorded.
 - When the recording time is set to "Greeting only":
"Hello, we are not available now. Please call again. Thank you for your call."

Flash Memory Message Backup (Message storage)

Messages stored in memory will not be affected by power failures. All messages are saved until you erase them.

Caller's Recording Time Handset

You can select "1 minute", "2 minutes", "3 minutes" or "Greeting only" for the caller's recording time. The factory preset is "3 minutes".

1 Press [MENU].

2 Scroll to "Initial setting" by pressing [V] or [Λ], then press **Select**.

Initial setting
↓Exit ∨Λ Select↓

3 Scroll to "Set answering" by pressing [V] or [Λ], then press **Select**.

Set answering
↓Back ∨Λ Select↓

4 Scroll to "Recording time" by pressing [V] or [Λ], then press **Select**.

Recording time
↓Back ∨Λ Select↓

5 Select the recording time by pressing [V] or [Λ].

- You can also select the recording time by pressing dialing buttons [1], [2], [3] or [0] (Greeting only).

Recording time
: 3min
↓Back ∨Λ Save↓

6 Press **Save**, then press [OFF].

- When "Greeting only" is selected, the unit will answer calls by playing the greeting message, then hang up. The unit will not record any incoming messages.
- If you change the recording time to "Greeting only" when there are no new messages stored in the Answering System, the number of messages will disappear from the base unit display.

Preparing the Answering System

Number of Rings Handset

You can select the number of times the unit rings before the Answering System answers a call, from “2” to “7” or “Toll saver”*. The factory preset is “4”.

1 Follow steps 1 to 3 of “Caller’s Recording Time” on page 20.

2 Press **select** at “Number of rings”.

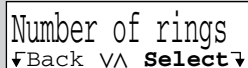

Number of rings
↓Back ∨∧ **select**↓

3 Select the number of rings by pressing [**V**] or [**∧**].

- You can also select the number of rings by pressing [**0**] (Toll saver*), or [**2**] to [**7**].

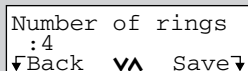

Number of rings
:4
↓Back ∨∧ **Save**↓

4 Press **save**, then press [**OFF**].

*Toll saver

When you call the unit from a remote operation, the number of rings will tell you if there are any new messages. If the unit answers on the 2nd ring, there is at least one new message. If the unit answers on the 4th ring, there are no new messages. To save the toll charges for the call, hang up immediately when you hear the 3rd ring. The 3rd ring indicates that there are no new messages.

Making Calls

Handset

- 1 Press [↵].
 - “Talk” is displayed.
- 2 Dial a phone number.
 - The dialed number is displayed.
 - After a few seconds, the display will show the length of the call.
- 3 To hang up, press [OFF] or place the handset on the base unit.

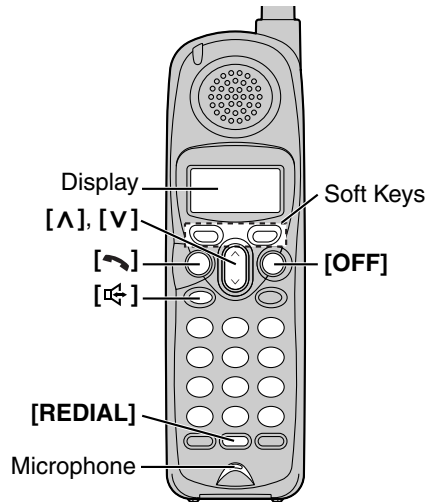

To have a hands-free phone conversation

- 1 Press [☎].
 - “SP-phone” is displayed.
- 2 Dial a phone number.
 - The dialed number is displayed.
 - After a few seconds, the display will show the length of the call.
- 3 When the other party answers, talk into the microphone.
- 4 To hang up, press [OFF] or place the handset on the base unit.

Hands-free Digital Duplex Speakerphone

For best performance, please note the following:

- Talk alternately with the other party in a quiet room.
 - If you or the other party has hearing difficulty, press [v] to decrease the speaker volume.
 - While talking using [↵], you can switch to the hands-free phone conversation by pressing [☎]. To switch back to the receiver, press [↵].
- If the handset has lost communication with the base unit, the handset beeps 3 times and “No link to base. Place on cradle and try again.” is displayed.
 - If [↵], [☎] or any other buttons except [MUTE] and [OFF] is pressed while the handset is on the base unit, the handset beeps 3 times and “Please lift up and try again.” is displayed. Lift the handset and press the button again.

To dial after confirming the entered number

1 Enter a phone number.

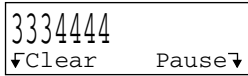

- If you misdial, press **Clear**. Enter the correct number.
- If a pause is required for dialing, press **Pause** where needed (p. 39).
- To cancel, press **[OFF]**.

2 Press **[↵]** or **[↶]**.

3 To hang up, press **[OFF]** or place the handset on the base unit.

If noise interferes with the conversation

Have the unit select a clearer channel by doing one of the following:

Press **[↵]** (Channel) if talking using **[↵]**,

press **[↶]** (Channel) if talking using **[↶]**, or

press **CH**, which is displayed when you adjust receiver or speaker volume (p. 24).

OR

Walk closer to the base unit.

To redial the last number dialed

Press **[↵]** or **[↶]**, then press **[REDIAL]**.

To redial using the redial list (Memory Redial)

The last 5 phone numbers dialed with the handset are stored in the redial list.

1 Press **[REDIAL]**.

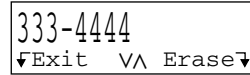

- The last number dialed is displayed.

2 Scroll to the desired number by pressing **[V]** or **[^]**.

- You can also scroll through the list by pressing **[REDIAL]**.
- To exit the list, press **[OFF]** or **Exit**.

3 Press **[↵]** or **[↶]**.

- **To erase an item**, scroll to the desired item then press **Erase**.
- If "No items stored" is displayed, the list is empty.

To put a call on hold

Press **Hold** during a conversation.

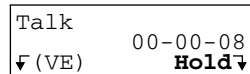

- "Hold" is displayed.
- To page the base unit while holding, press **Intercom** (Intercom hold).

To return to the call, press **[↵]** or **[↶]**.

- If another phone is connected on the same line, you can also return to the call by lifting its handset.
- If a call is kept holding for 6 minutes, an alarm tone will start to sound. After 4 additional minutes on hold, the call will be disconnected.
- The alarm volume corresponds to the ringer volume level (p. 17). If the ringer is OFF, the alarm will sound at the LOW level.

Making Calls

To adjust the receiver/speaker volume while talking

3 levels (HIGH, MEDIUM and LOW) are available for the receiver and 6 levels for the speaker.

To increase volume, press [**▲**].

To decrease volume, press [**▼**].

- The display shows the current volume setting.
- If you try to increase/decrease volume when it is at the maximum/minimum level, the handset will beep 3 times.

Ex. Receiver volume: HIGH
Speaker volume: level 6



Backlit LCD display

The lighted display of the handset will stay on for a few seconds after pressing a button or lifting the handset off the base unit.

Lighted handset keypad

The handset dialing buttons will light when you press a button or lift the handset off the base unit. The light will go out after a few seconds.

Answering Calls

When a call is received, the unit rings and “Incoming call” is displayed, and the Ringer indicator on the handset and the IN USE/CHARGE indicator on the base unit flash rapidly. If you subscribe to a Caller ID service, see page 26.

Handset

1 Press [] or [].

- You can also answer a call by pressing any button except [**V**], [**Λ**] and [**OFF**].

2 To hang up, press [**OFF**] or place the handset on the base unit.

Auto Talk:

If you set the Auto Talk feature to ON (p. 15), you can answer a call by lifting the handset off the base unit.

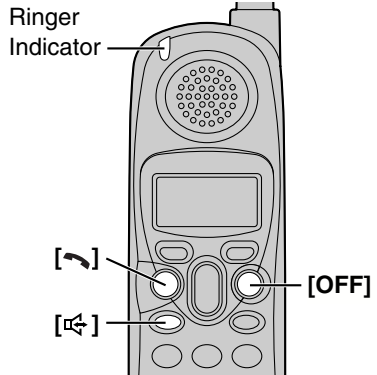

- When the ringer volume is set to OFF, the unit will not ring (p. 17).

Caller ID Service

This unit is compatible with Caller ID services offered by your telephone company. If you subscribe to Caller ID, the caller's name and phone number will be displayed and recorded in the Caller List.

How caller information is displayed when a call is received

When a call comes in, the unit will ring and caller ID information will be received. Once caller ID information is received, the handset display shows the caller's information.

Example

ROBINSON, TINA 1-555-222-3333

- After you answer the call, the display will show the length of the call.
- If the unit does not receive caller ID information, one of the following will be displayed:

Display	Meaning
Out of area	The caller dialed from an area which does not provide Caller ID service.
Private caller	The caller requested not to send his/her information.
Long distance	The caller made a long distance call.

- If your unit is connected to a PBX which does not support Caller ID, you cannot access Caller ID service.
- The name display service may not be available in some areas. For further information, please contact your telephone company.
- If you subscribe to both Caller ID and Call Waiting, when talking on the phone as another call comes in, the second caller's name and phone number will be displayed (p. 38).

Using the Caller List

The unit can record information up to 30 different callers and store this information in the Caller List. Caller information is sorted by the most recent call to the oldest. When the 31st call is received, the information from the 1st call is deleted.

The unit will also tell you how many calls you missed while you were out or unavailable to answer the phone.

Handset off the base unit

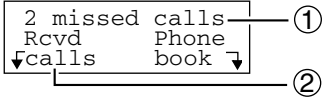

① The display will show the number of calls you missed.

- After viewing the missed call entries, “missed calls” will disappear from the display.

Handset on the base unit

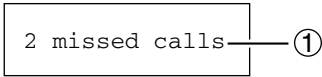

② Press **Rcvd calls** to review other calls logged in the Caller List.

- If there are no items in the Caller List, “Rcvd calls” will not be displayed.

Viewing the Caller List Handset

1 Press **Rcvd calls** to enter the Caller List.

- You can also enter by pressing [V] or [Λ].

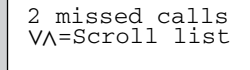
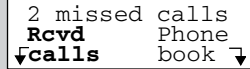

2 To search from the most recent call, press [V]. To search from the oldest call, press [Λ].

- The caller's name, number and the time and date received are displayed. Name and phone number are alternately displayed as shown on the right.

Example

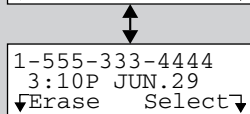
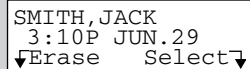

3 To exit the list, press [OFF].

- If there is no name information of a caller, the display will only show the phone number.
- If you do not press any buttons for 60 seconds, the unit will exit the Caller List.

Using the Caller List

What “√” means

“√” indicates you have already viewed this calling information, answered the call, called back the caller or played back the message (p. 41, 42). If the same caller calls again, the call entry with “√” will be replaced with the new call entry.

SMITH, JACK 3:10P JUN.29 √

If a caller calls more than once

The number of times the same caller called is displayed (“x2” to “x9”). The date and time of the most recent call will be recorded. After viewing a caller’s information, “x2” to “x9” will be replaced with “√”.

TURNER, CINDY 11:20A JUN.12 X2

Calling Back from the Caller List Handset

1 Press **Rcvd calls** to enter the Caller List.

- You can also enter by pressing [**V**] or [**Λ**].
-

2 Scroll to the desired caller by pressing [**V**] or [**Λ**].

3 Press [**↶**] or [**↷**].

- The phone number is dialed.
-

- In some cases, you may have to edit the number before dialing (p. 29). (Ex. You may have to delete “1” and the area code.)
- If a phone number is not displayed in the caller information, you cannot call back that caller from the Caller List.

Editing the Caller's Phone Number Handset

You can edit a phone number in the Caller List to call it back or store it in the phone book.

Caller ID Number Auto Edit Feature (p. 30)

This feature allows the unit to edit a Caller ID number into one of 3 patterns automatically in the Caller List. For details and activation, see page 30.

1 Press **Rcvd calls** to enter the Caller List.

- You can also enter by pressing [V] or [Λ].

```

2 missed calls
Rcvd      Phone
calls     book
↓        ↓
    
```

```

2 missed calls
VΛ=Scroll list
    
```

2 Scroll to the desired caller by pressing [V] or [Λ].

- Name and phone number are alternately displayed as shown on the right.

```

PARKER, FRED
11:20A JAN.12
↓Erase  Select↓
    
```

```

1-555-321-5555
11:20A JAN.12
↓Erase  Select↓
    
```

3 Press **Select**.

4 Press **Edit**.

- Each time you press **Edit**, the number is rearranged into one of 3 patterns.

- Ⓐ Phone no.
- Ⓑ Area code — Phone no.
- Ⓒ 1—Area code — Phone no.

- The order in which patterns Ⓐ–Ⓒ are displayed depends on how the telephone number is displayed in step 2.

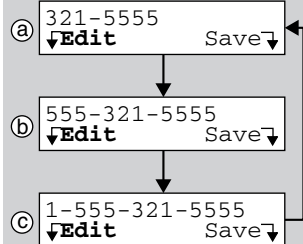

5 To continue with making a call from the Caller List, press [↶] or [↷].

To continue with storing the number in the phone book, press **Save**.

- If there is no name information, see page 31.

Using the Caller List

Caller ID Number Auto Edit Feature Handset

There are 3 patterns of phone number (Ⓐ, Ⓑ and Ⓒ, p. 29). This feature allows your phone to automatically edit an in-coming Caller ID number into a pattern of your choice, and display the Caller ID number with that pattern.

After this feature is activated, Caller ID numbers coming from specific area codes (201, for example), from which the Caller ID numbers have been chosen to follow the desired pattern (7-digit pattern, for example), will be automatically edited from other patterns (11-digit pattern, for example) into the same pattern you have previously selected (which is 7-digit pattern, in this example).

Up to 4 area codes can be designated for this feature for pattern Ⓐ, Ⓑ and Ⓒ (p. 29).

To activate this feature, you must (1) set this feature to ON, and (2) make an outgoing call from Caller List (p. 28) with a number which has one of the 3 patterns that you have edited with specific area codes, and that you prefer to be followed by future Caller ID numbers, so that in the future all the Caller ID numbers coming from the same area code will be displayed in the same pattern.

The Caller ID number Auto Edit feature is preset at the factory to ON.

- If a call does not go through, the phone number you dialed may have an incorrect pattern. Please edit the phone number with another pattern (p. 29).

For example, if you move to another area, you may need to turn this feature OFF to erase previously edited area codes. Then, if still necessary, you may activate this feature again.

1 Press **[MENU]**.

2 Scroll to “Initial setting” by pressing **[V]** or **[Λ]**, then press **Select**.

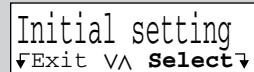

Initial setting
↓Exit VΛ Select↓

3 Scroll to “Caller ID edit” by pressing **[V]** or **[Λ]**, then press **Select**.

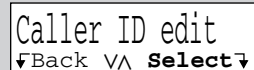

Caller ID edit
↓Back VΛ Select↓

4 Select “Off” or “On” by pressing **[V]** or **[Λ]**.



Auto edit :On
↓Back VΛ Save↓

5 Press **save**, then press **[OFF]**.

- When the feature is set to OFF, the unit will still be able to display Caller ID, but the in-coming Caller ID number will not be edited by a pattern or area codes.

Storing Caller Information in the Phone Book

Handset

Callers' names and phone numbers that are in the Caller List can be stored in the phone book.

1 Press **Rcvd calls** to enter the Caller List.

- You can also enter by pressing [V] or [Λ].

```

2 missed calls
Rcvd      Phone
↓calls    book ↓
    
```

```

2 missed calls
VΛ=Scroll list
    
```

2 Scroll to the desired caller by pressing [V] or [Λ].

- If the number requires editing, see page 29.
- Name and phone number are alternately displayed as shown on the right.

```

TURNER, CINDY
11:00A JUN.12 X3
↓Erase   Select↓
    
```

```

1-555-456-7890
11:00A JUN.12 X3
↓Erase   Select↓
    
```

3 Press **Select**.

4 Press **Save**.

- To continue storing other items, repeat from step 2.

If there is no name information for the caller, **"Enter name"** will be displayed.

- If a name is not required, press [V] then press **Save**.
- If a name is required, enter the name (p. 34). When finished, press [V] then press **Save**.

- To continue storing other items, repeat from step 2.

```

TURNER, CINDY
1-555-456-7890
↓Edit      Save↓
    
```

```

Enter name
          V=Next  ▶↓
    
```

```

CINDY TURNER
◀ V=Next ▶
    
```

5 Press **[OFF]**.

- If the handset beeps 3 times and "Phone book full" is displayed in step 4, press **[OFF]** to exit the list. To erase other stored items from the phone book, see page 36.
- You cannot store caller information in the phone book if a phone number is not displayed.
- If the handset beeps 3 times and "Save error" is displayed in step 4, the item cannot be stored in the phone book. Place the handset on the base unit and try again from step 1.

Using the Caller List

Erasing Caller Information Handset

To erase a specific caller

1 Press **Rcvd calls** to enter the Caller List.

- You can also enter by pressing [V] or [^].

2 missed calls
Rcvd Phone
calls book ↵

2 missed calls
V^=Scroll list

2 Scroll to the desired caller by pressing [V] or [^], then press **Erase**.

- To erase other items, repeat step 2.
- To exit the Caller List, press [OFF].

REAGAN, TOM
12:20A JUN.12
Erase Select ↵

Erased

To erase all entries

If the display shows that you have “missed calls”, you cannot erase all Caller List entries. Before erasing all entries, make sure that you have viewed all missed calls.

1 Press **Rcvd calls** to enter the Caller List.

- You can also enter by pressing [V] or [^].

Rcvd Phone
calls book ↵

2 Press **All erase**.

0 missed call
V^=Scroll list
All erase

3 Press **Yes**.

- A beep sounds and all entries in your Caller List are erased.

All erase?
No **Yes** ↵

All erased

- To cancel erasing, press **No** after step 2.

Phone Book

You can store up to 50 names and phone numbers in the handset phone book. All phone book items are sorted alphabetically. You can make a call by selecting a name on the handset display.

Storing Names and Numbers Handset

1 Press **Phone book**.



Rcvd calls **Phone book** ↓

2 Press **Add**.

- When 50 items are stored in the phone book, "Add" is not displayed. To erase an item, see page 36.

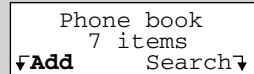

Phone book
7 items
↓ **Add** Search ↓

3 Enter a name, up to 15 characters with the dialing buttons (**[0]** to **[9]**) (p. 34), then press **[V]**.

- If a name is not required, press **[V]** then go to step 4.

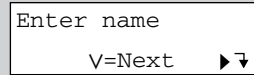

Enter name
v=Next ▶ ↓

Example ↓

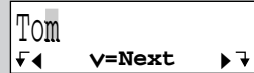

Tom
↓ ◀ v=Next ▶ ↓

4 Enter a phone number, up to 32 digits.

- Each time you press **◀**, a digit is erased. To erase all of the digits, press and hold **◀**.
- If a pause is required for dialing, press **P**. A pause is stored in a phone number as one digit (p. 39).

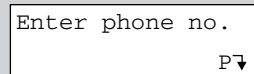

Enter phone no.
P ↓

Example ↓

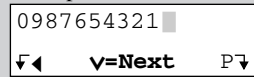

0987654321
↓ ◀ v=Next P ↓

5 Press **[V]**.

- If you want to change the name, press **Edit** then change it.
- If you want to change the number, press **[^]** then change it.

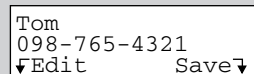

Tom
098-765-4321
↓ **Edit** Save ↓

6 Press **Save**.

- To continue storing other items, repeat from step 2.
- When you store the 50th item, "Phone book full" is displayed.

7 Press **[OFF]**.

- If the handset beeps 3 times when you press **Save**, the item cannot be stored in the phone book. Place the handset on the base unit and try again from step 1.

Phone Book

Selecting characters to enter names

Enter names using the dialing buttons. Press each button until the desired character is displayed.

- Pressing each button selects a character in the order shown below.

Keys	Characters	Keys	Characters
[1]	# & ' () * , - . / 1	[6]	m n o M N O 6
[2]	a b c A B C 2	[7]	p q r s P Q R S 7
[3]	d e f D E F 3	[8]	t u v T U V 8
[4]	g h i G H I 4	[9]	w x y z W X Y Z 9
[5]	j k l J K L 5	[0]	0 Space
◀	Erases the character to the left.		
▶	Moves the cursor to the right. (To enter another character using the same number key, move the cursor to the next space.)		

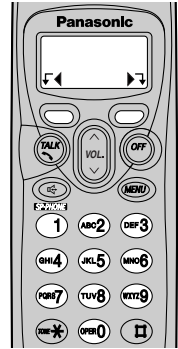

For example, to enter “Tom”:

1 Press [8] four times.	T
2 Press [6] three times, then press ▶ to move the cursor.	To
3 Press [6].	Tom

If you make a mistake when entering a name or number

Use ◀ to erase the incorrect character. Each time you press ◀, a character is erased. Then re-enter the correct character.

To erase all characters, press and hold ◀.

Dialing from the Phone Book Handset

1 Press **Phone book** to enter the phone book.

2 Press **Search**.

Phone book
7 items

↓Add Search↓

3 Scroll to the desired item. To scroll down, press [V]. To scroll up, press [Λ].

0-9=Name search
VΛ=Scroll list

Phone book items are sorted in the following order:

1	Alphabet letters (Alphabetical)
2	Space & ' () , - . /
3	Numbers 0 to 9
4	# *
5	Telephone numbers (If no name is stored)

4 Press **Call**, [↵] or [☎].

- The displayed phone number is dialed.

Frank
444-5555

↓Call Select↓

5 To hang up, press [OFF] or place the handset on the base unit.

- To exit the phone book list, press [OFF].
- If “No items stored” is displayed in step 2, the phone book is empty.
- To view a phone number over 16 digits, repeat steps 1 to 3, then press **Select**, **Edit** and then [V]. When finished, press [OFF].

To search for a name by initial

- Repeat the steps 1 and 2 above.
- Press the dialing button for the first letter of the desired name until any name with the same initial is displayed (see the Index table below).
Ex. To find “Frank”, press [3] repeatedly until the first item under “F” is displayed.
 - If there are no items in the index you selected, the first entry in the next alphabetical index will be displayed.
- Press [V] repeatedly until the desired name is displayed.

Index table

Keys	Index	Keys	Index
[1]	Other symbols, 1	[6]	M, N, O, 6
[2]	A, B, C, 2	[7]	P, Q, R, S, 7
[3]	D, E, F, 3	[8]	T, U, V, 8
[4]	G, H, I, 4	[9]	W, X, Y, Z, 9
[5]	J, K, L, 5	[0]	0, Space

Phone Book

Editing an Item in the Phone Book Handset

1 Press **Phone book** to enter the phone book.

2 Press **Search**.

3 Scroll to the desired item by pressing [V] or [Λ], then press **Select**.

- To search for the item by initial, see page 35.

Jane
345-6789
↓Call **Select**↓

4 Press **Edit**.

Jane
345-6789
↓Erase **Edit**↓

5 Edit the name (p. 34), then press [V].

- If you do not need to change the name, press [V] then go to step 6.

Jane Walker
↓◀ **v=Next** ▶↓

6 Edit the phone number, then press [V].

- If you do not need to change the number, press [V] then go to step 7.
- If a pause is required for dialing, press **P**. A pause is stored in a phone number as one digit (p. 39).

5553456789
↓◀ **v=Next** P↓

7 Press **Save**.

- To continue editing other items, repeat from step 2.

8 Press [OFF].

Erasing an Item in the Phone Book Handset

1 Press **Phone book** to enter the phone book.

2 Press **Search**.

3 Scroll to the desired item by pressing [V] or [Λ], then press **Select**.

- To search for the item by initial, see page 35.

Helen
666-777-8888
↓Call **Select**↓

4 Press **Erase**.

Helen
666-777-8888
↓Erase **Edit**↓

5 Press **Yes**.

- A beep sounds and the item is erased.
- To erase other items, repeat from step 3.

Erase?
↓No **Yes**↓

6 Press [OFF].

- To cancel erasing, press **No** after step 4.

Intercom

Handset

Base Unit

A 2-way intercom can be set up between the base unit and the handset.

Paging the base unit from the handset

1 Handset:

Press **[MENU]**.

2 Handset:

Scroll to “Intercom” by pressing **[V]** or **[^]**, then press **select**.

3 Base unit:

When the other party’s voice is heard after the beeps, answer using the **MIC**.

- The IN USE/CHARGE indicator lights.

4 To disconnect the intercom, press **[OFF]** on the handset.

OR

Press **[LOCATOR/INTERCOM]** on the base unit.

- The IN USE/CHARGE indicator goes out.

Paging the handset from the base unit (Handset locator)

Using this feature, you can also locate the misplaced handset.

1 Base unit:

Press **[LOCATOR/INTERCOM]**.

- The handset beeps for 1 minute and displays “Paging”.
- The Ringer and IN USE/CHARGE indicators flash.
- To stop paging, press **[LOCATOR/INTERCOM]** on the base unit.

2 Handset:

Press **Intercom** to answer.

- The handset displays “Intercom”.

3 Base unit:

Talk into the **MIC**.

4 To disconnect the intercom, press **[OFF]** on the handset.

OR

Press **[LOCATOR/INTERCOM]** on the base unit.

- The IN USE/CHARGE indicator goes out.

- If you do not want to answer the page in step 2, press **[OFF]** to stop paging.

During an intercom call:

- If the handset user has difficulty hearing the base unit user, decrease the base unit speaker volume by pressing **VOL. [V]**.
- If noise interferes with the conversation, press **CH** while “CH” is shown on the handset display. The unit selects a clearer channel.
- If an incoming call is being received, the intercom call stops and the unit starts to ring. To answer, press **[hook]** or **[hook]**.

For assistance, please call: 1-800-211-PANA(7262)

Download from www.Somanuals.com. All Manuals Search And Download.

Special Features

Automatic Security Code Setting Handset

Each time you place the handset on the base unit, the unit automatically selects one of a million security codes. These codes help prevent the unauthorized use of your telephone line by another cordless telephone user.

Temporary Tone Dialing (For Rotary or Pulse Service Users) Handset

Press [*****] (TONE) before entering access numbers which require tone dialing.

- The dialing mode changes to tone. You can enter numbers to access an answering service, electronic banking service, etc. When you hang up, the dialing mode will return to pulse.

Muting Your Conversation Handset

During a call, you can mute your phone so the other party cannot listen to you. When muting your conversation, you can hear the other party.

Press [**MUTE**].

- “<Mute>” will flash.

Talk	
>Mute>	00-00-30
↓(VE)	Hold↓

- To release the mute, press [**MUTE**], [**↶**] or [**↷**].

For Call Waiting Service Users Handset

Press [**FLASH/CALL WAIT**] if you hear a call-waiting tone while talking.

- The first call is put on hold and you can answer the second call.
- To return to the first caller, press [**FLASH/CALL WAIT**] again.
- Call waiting service cannot be used when:
 - the Answering System is responding to a call, or
 - a parallel connected telephone is in use.
- If this function does not operate properly, consult your telephone company for details.

Call Waiting Caller ID

If you subscribe to both Caller ID and Call Waiting, when talking on the phone as another call comes in, the second caller's name and phone number will be displayed.

After you hear a call-waiting tone while talking, the display shows the caller's name with the phone number and “----Waiting-----”.

BROWN, NANCY
1-555-666-7777
----Waiting-----

- Contact your telephone company for details and availability in your area.

Using the PAUSE Key (For PBX Line/Long Distance Calls)

Handset

We recommend you press **Pause** or **P** if a pause is required to dial with a PBX or to make a long distance call.

Ex. Line access number **[9]** (PBX)

[9] → **Pause** or **P** →

Example

9P15556667777	
↓Clear	Pause↓
OR	
9P1234567890	
↓	↵=Next P↓

- Pressing **Pause** or **P** once creates a 3.5 second pause. This prevents misdialing when you dial after confirming the entered number (p. 23) or dial a stored number (p. 35).
- Pressing **Pause** or **P** more than once increases the length of the pause between numbers.

FLASH Button

Handset

Pressing **[FLASH/CALL WAIT]** allows you to use special features of your host PBX such as transferring an extension call, or access optional telephone services such as call waiting.

- Pressing **[FLASH/CALL WAIT]** cancels following operations:
 - temporary tone dialing, or
 - muting your conversation.

Selecting the flash time

The flash time required depends on your telephone exchange or host PBX. You can select the following flash times: “700, 600, 400, 300, 250, 110, 100 or 90 ms (milliseconds)”. The factory preset is “700 ms”.

- If PBX functions do not work correctly, consult your PBX supplier for the correct settings.

1 Press **[MENU]**.

2 Scroll to “Initial setting” by pressing **[V]** or **[Λ]**, then press **Select**.

Initial setting
↓Exit ↵Λ Select↓

3 Scroll to “Set tel line” by pressing **[V]** or **[Λ]**, then press **Select**.

Set tel line
↓Back ↵Λ Select↓

4 Scroll to “Set flash time” by pressing **[V]** or **[Λ]**, then press **Select**.

Set flash time
↓Back ↵Λ Select↓

5 Select the desired time by pressing **[V]** or **[Λ]**.

Set flash time
: 700ms
↓Back ↵Λ Save↓

6 Press **save**, then press **[OFF]**.

Automatic Answering Operation

When the unit answers a call, a greeting message is played and the caller's message is recorded. When the handset is on the base unit, the Ringer indicator on the handset will flash to indicate a message is being recorded.

- The total recording time (including greeting message) is **about 15 minutes**. If messages are recorded in noisy rooms, the time may be shortened by up to 3 minutes.
- A maximum of 64 messages (including greeting message) can be recorded.

Setting the Unit to Answer Calls

Base Unit

Press **[ANSWER ON]** to turn on the Answering System.

- The button lights and the unit announces "Answer set" and current day and time. If "Set time" is heard, set the date and time (p. 12).
- The unit will announce the remaining recording time if it is less than 3 minutes.
- When the remaining recording time is 0, "**FULL**" will be displayed on the base unit, **[ANSWER ON]** will flash rapidly and the unit will announce "Memory full". You need to erase any unnecessary messages before new messages can be recorded (p. 44).
- To turn the Answering System off, press **[ANSWER ON]** again. The button light goes out and "Answer off" is heard.
- The Answering System can be turned on remotely using any other phone (p. 47).

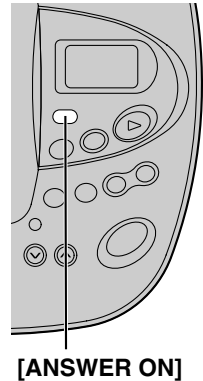

Handset

- 1 Press **[MENU]**.
- 2 Scroll to "Message play" by pressing **[V]** or **[^]**, then press **Select**.
- 3 Press **[8]** to turn on the Answering System.
 - "Answer set" is heard.
- 4 Press **[OFF]**.
 - To turn the Answering System off, press **[0]** in step 3. "Answer off" is heard.

Automatic Answering Operation

Monitoring incoming calls

While a call is being recorded, you can monitor it through the base unit speaker.

- To increase the speaker volume, press **VOL. [▲]**. To decrease volume, press **VOL. [▼]**.

To answer the call, press [📞] or [📞] on the handset. The unit will stop recording.

Listening to Messages

You can see the total number of recorded messages on the base unit display. When new messages have been recorded, the NEW MESSAGE indicator flashes.

Voice Day/Time Stamp: During playback, the unit will announce the day and time when each message was recorded (p. 12).

Using the Base Unit **Base Unit**

To play back messages

Press **[MESSAGE/SLOW TALK]**.

- The unit announces the number of new messages and only new messages are played back.

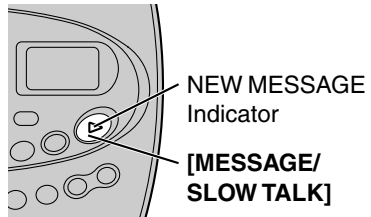

- During playback, the display shows the message number.
- At the end of the last message, "End of final message" is heard. The unit will announce the remaining recording time if it is less than 3 minutes.
- **When you have no new messages**, the unit announces "No new messages. All message playback" and plays back all messages.
- When you have no messages, the unit announces "No messages".

Listening to Messages

Using the Handset (Remote Operation) Handset

To play back messages

1 Press [MENU].

2 Scroll to “Message play” by pressing [V] or [^], then press **Select**.

- The unit announces the number of new messages and only new messages are played back.
- The messages will be heard from the speaker. To switch to the receiver, press [↶]. To switch back to the speaker, press [↷].
- [MESSAGE/SLOW TALK], [REPEAT], [SKIP] and [STOP]* can also be used during playback (p. 43).
- **When you have no new messages**, the unit announces “No new messages. All message playback” and plays back all messages.
- **When you have no messages**, the unit announces “No messages”.
- If you do not press any buttons, the voice menu will start (see below).

Message play
↓Exit V^ Select↓

4:New messages
5:All messages
↓Repeat Skip↓

3 To end remote operation, press [OFF] or place the handset on the base unit.

*If you press [STOP] on the base unit during message playback, operation is stopped. To resume the playback, press [MESSAGE/SLOW TALK] on the base unit within 15 seconds, or the voice menu will start (see below).

- If noise interferes with the message playback:
 - during playback using [↶], press [↶] (Channel).
 - during playback using [↷], press [↷] (Channel).The unit selects a clearer channel.
- At the end of the last message, “End of final message” is heard. The unit will announce the remaining recording time if it is less than 3 minutes.
- If the unit starts to ring during the remote operation, press [↶] or [↷] to answer the call. To playback, start again from the beginning after hanging up.
- If you hear “Memory full” after playback, erase unnecessary messages (p. 44).

Voice menu

If you do not press any buttons at the end of the last message, the unit will announce “End of final message” and the voice menu will begin.

The unit announces, “Press 4 to play back new messages. Press 5 to play back all messages.”

- You can press buttons for other options (p. 43) even if the voice menu has started.
- If you do not press any buttons within 10 seconds, the handset will exit remote operation.

Listening to Messages

During playback

To adjust the speaker volume	<i>Base unit or Handset:</i> To increase volume, press [Λ]. To decrease volume, press [V]. <ul style="list-style-type: none">• You can also adjust the receiver volume on the handset.
To slow down the playback speed (Slow Talk Message Playback)	<i>Base unit:</i> Press [MESSAGE/SLOW TALK]. <i>Handset:</i> Press [3]. <ul style="list-style-type: none">• To return to normal speed, press [MESSAGE/SLOW TALK] on the base unit or [3] on the handset.• Each time you press the button during playback, the speed will change to slow/normal.• Playback speed will return to normal after you finish listening to messages.
To repeat a message	<i>Base unit:</i> Press [REPEAT]. <i>Handset:</i> Press Repeat or [1]. <ul style="list-style-type: none">• If pressed within the first 5 seconds of playback, the previous message will be played.
To skip message	<i>Base unit:</i> Press [SKIP]. <i>Handset:</i> Press skip or [2].
To stop playback	<i>Base unit:</i> Press [STOP]. <ul style="list-style-type: none">• To resume playback, press [MESSAGE/SLOW TALK].• If you do not press any button for 60 seconds or if you press [STOP] again, playback mode will be canceled. <i>Handset:</i> Press [9]. <ul style="list-style-type: none">• If you do not press any button within 15 seconds after stopping playback, the voice menu will start (p. 42).

For Caller ID service users (p. 26)

During playback, when the handset is on the base unit, the handset display will show the name and/or number of the caller whose message is being played.

To call back the displayed number:

During playback, lift the handset and press **Ca11**, [**↶**] or [**↷**] within 10 seconds.

- The unit stops playback and dials the phone number.
- After listening to a new incoming message, “√” will be added to its call entry in the Caller List (p. 28).

Erasing Messages

The unit will announce the remaining recording time after playback, if it is less than 3 minutes. New messages cannot be recorded when:

- “Memory full” is heard.
- “**FULL**” is displayed on the base unit.
- [ANSWER ON]** flashes rapidly (when the Answering System is on).

Erase unnecessary messages. We recommend you erase unnecessary messages after each playback.

Erasing a specific message

Base Unit

Press **[ERASE]** while the message you want to erase is being played.

Handset

Press **[*] [4]** while the message you want to erase is being played.

- The unit beeps, then plays back the next message.

Erasing all messages

All recorded messages, except the greeting message, can be erased at one time.

Base Unit

1 Press **[ERASE]**.

- “To erase all messages, press ERASE again” is heard.

2 Within 10 seconds, press **[ERASE]** again.

- The unit beeps, then announces “No messages”.
- The base unit display shows “0”.



Handset

1 Press **[MENU]**.

2 Scroll to “Message play” by pressing **[V]** or **[Λ]**, then press **select**.

3 Press **[*] [5]**.

- The unit beeps, then announces “No messages”.
- To cancel playback on the handset, press **[OFF]**.
- Information in the Caller List will not be erased. To erase Caller information, see page 32.

Remote Operation from a Touch Tone Phone

You can operate the Answering System from any touch tone phone.

A synthesized voice menu will guide you through the Answering System (p. 46).

- To skip the voice menu and operate the unit directly, see page 47.

Summary of remote operation

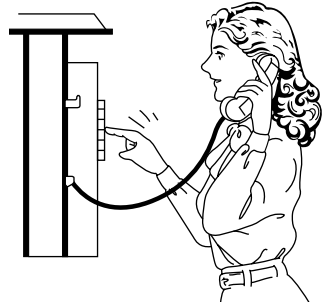
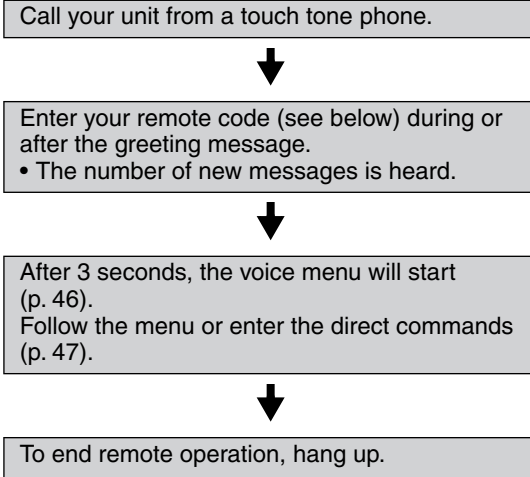

- The unit will announce the remaining recording time after playback, if it is less than 3 minutes.
- The messages are saved.

Remote Code Handset

The remote code prevents unauthorized people from accessing your unit and listening to your messages. Choose any **2-digit number (00–99)** for your remote code.

The factory preset remote code is “11”. If you do not program your own remote code, you can use “11”.

1 Press **[MENU]**.

2 Scroll to “Initial setting” by pressing **[V]** or **[Λ]**, then press **Select**.

Initial setting
↓Exit ∨Λ Select↓

3 Scroll to “Set answering” by pressing **[V]** or **[Λ]**, then press **Select**.

Set answering
↓Back ∨Λ Select↓

4 Scroll to “Remote code” by pressing **[V]** or **[Λ]**, then press **Select**.

Remote code
↓Back ∨Λ Select↓

5 Enter a **2-digit remote code (00–99)**.

Remote code :11
↓Back Save↓

6 Press **save**, then press **[OFF]**.

To check the remote code, repeat steps 1 to 4.

- The remote code is displayed. When finished, press **[OFF]**.

Remote Operation from a Touch Tone Phone

Voice Menu

The shaded boxes are voice prompts.

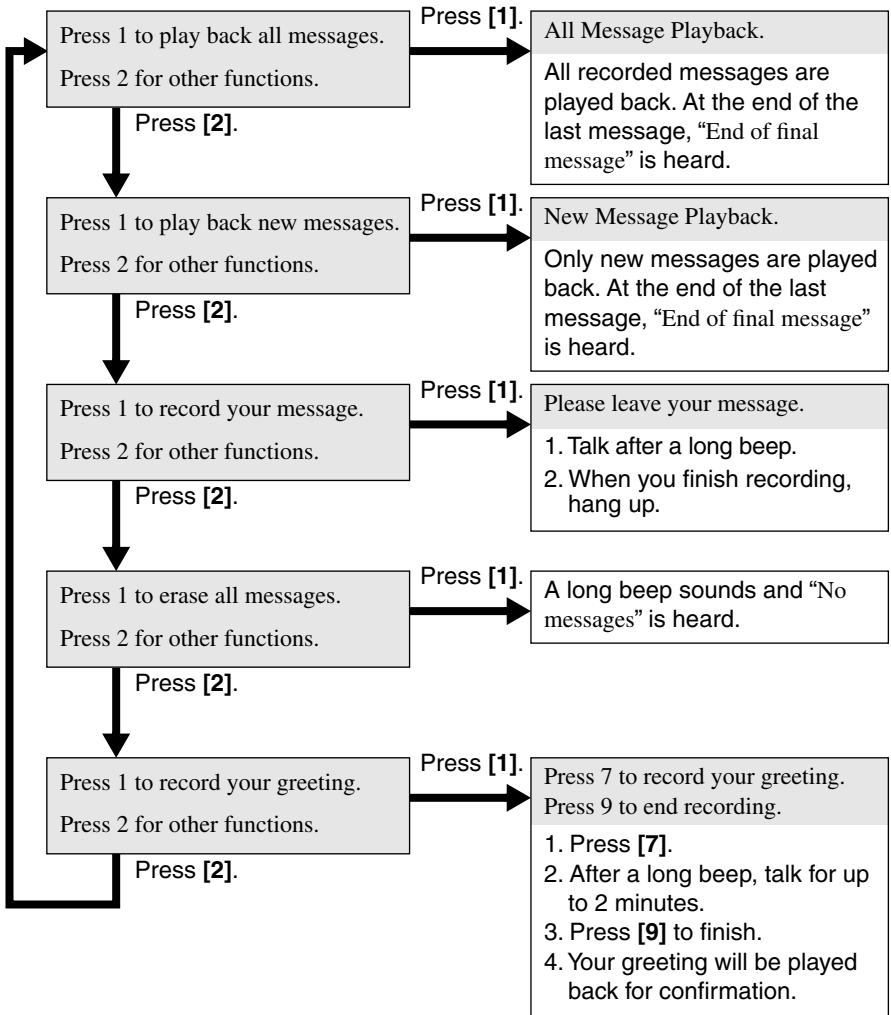

- 3 seconds after playback, the voice menu will start again from the beginning.
- The unit will announce the remaining recording time after playback if it is less than 3 minutes.
- If you hear "Memory full" after playback, erase unnecessary messages (p. 47).
- If you do not press any buttons within 10 seconds after a voice prompt, "Thank you for your call." will be heard and the call will be disconnected.

Remote Operation from a Touch Tone Phone

Direct Remote Operation

Once you have entered the remote code, you can also control your unit by direct commands instead of using the voice menu. To end remote operation, hang up anytime.

Direct commands

[4] :	Plays back new messages.	[7] :	Records a greeting message. After a long beep, talk for up to 2 minutes.
[5] :	Plays back all messages.	↓	
[1] :	Repeats the current message. <ul style="list-style-type: none">• If pressed within the first 5 seconds of playback, the previous message will be played.	[9]	Recording is stopped. The recorded message is played.
[2] :	Skips the current message.	[*] [4] :	Erases the current message. <ul style="list-style-type: none">• A short beep will sound and the next message will be played.
[3] :	Changes the playback speed to slow/normal.	[*] [5] :	Erases all messages. <ul style="list-style-type: none">• A long beep will sound and "No messages" will be heard.
[9] :	Stops the current operation. <ul style="list-style-type: none">• To resume operation, enter a direct command within 15 seconds, or the voice menu will start (p. 46).	[0] :	Turns off the Answering System. <ul style="list-style-type: none">• The unit hangs up.

To turn on the Answering System

Call your unit and wait for 15 rings.

- The unit will answer and the greeting will be played.
- The Answering System will be turned on. Hang up or enter the remote code for other options.
- When turning on the Answering System using a rotary or pulse service telephone, you cannot enter the remote code for other options.

Skipping the greeting

After calling your unit, press [*] during the greeting.

- The unit skips the rest of the greeting and you can start recording your message after a long beep.

Wall Mounting

This unit can be mounted on a wall phone plate.

- 1 Press the tabs in the direction of the arrows (①), then remove the wall mounting adaptor (②).

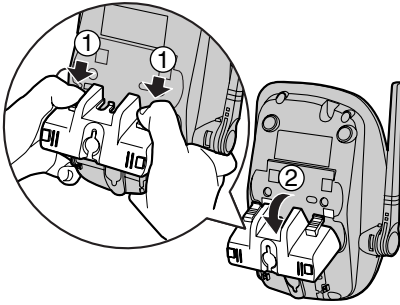

- 2 Connect the AC adaptor.
 - Fasten the AC adaptor cord to prevent it from being disconnected.

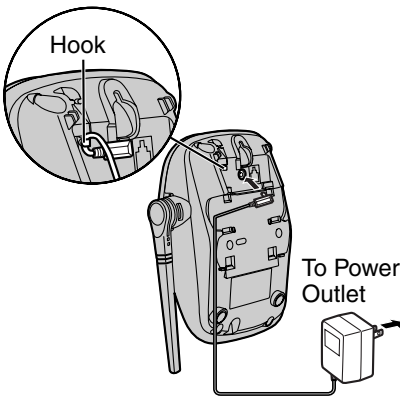

- 3 Tuck the telephone line cord inside the wall mounting adaptor, then push the adaptor in the direction of the arrows (① and ②).

- The word "UP WALL" should face upward.

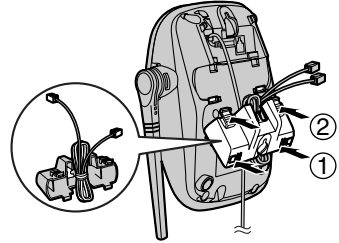

- 4 Connect the telephone line cord. Mount the unit, then slide down.
 - Raise the antenna.

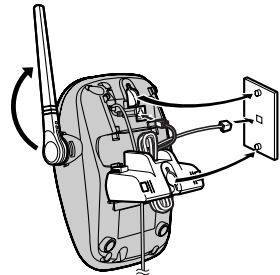

- 5 **To charge the handset battery:** Place the handset on the base unit.

- The IN USE/CHARGE indicator lights and the unit beeps once.

Belt Clip

You can hang the handset on your belt or pocket using the included belt clip.

To attach the belt clip

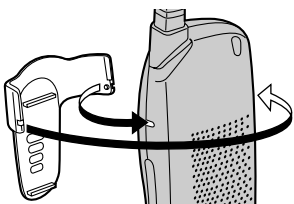

To remove the belt clip

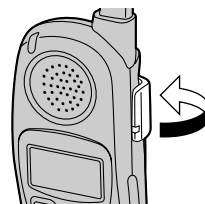

Shoulder Rest Attachment

Use the shoulder rest attachment if you need to keep your hands free during a phone conversation.

To attach the shoulder rest attachment

Attach the included belt clip to the handset (p. 48), then attach the shoulder rest attachment to the belt clip as shown below. You will hear a click when the shoulder rest attachment is in place.

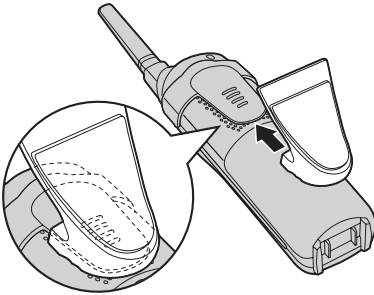

To remove the shoulder rest attachment

Slide the base of the attachment in the direction of the arrow as shown below.

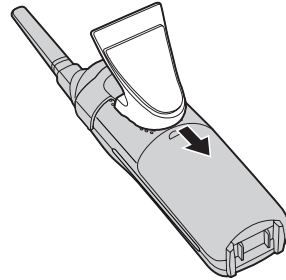

Optional Headset

Connecting an optional headset to the handset allows hands-free phone conversation. Use only a Panasonic KX-TCA60, KX-TCA86, KX-TCA88, KX-TCA91, KX-TCA92, or KX-TCA98 headset. To order, call the accessories telephone number on page 2.

Connecting an optional headset to the handset

Open the headset jack cover, and insert the headset plug into the headset jack as shown below.



- Headset sold separately. Model shown here is KX-TCA88.

To switch to the speakerphone while using the headset:
Press [📞]. To return to the headset, press [📞].

For assistance, please call: 1-800-211-PANA(7262)

Download from www.Somanuals.com. All Manuals Search And Download.

Direct Commands

Handset

After pressing [MENU], you can also program menu items by direct commands ([0] to [9]) instead of using the soft keys.

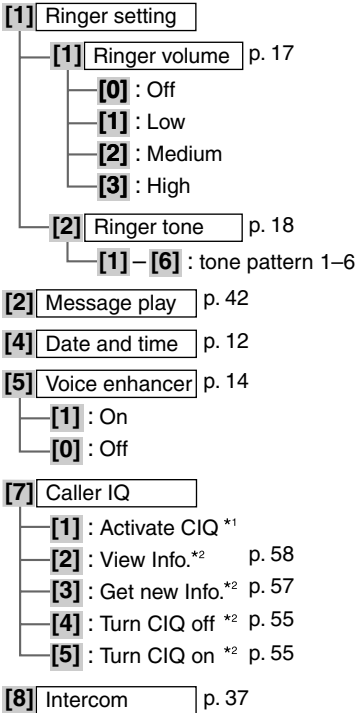

During programming:

To save the setting, press the right soft key (Save).

To exit the programming, press [OFF].

- If you press the direct command incorrectly, exit the programming. Then re-enter the programming by pressing [MENU].
- For function details, see the corresponding pages.

*1 Can be used to activate Caller IQ. See the leaflet included in the unit for more information.

*2 For openLCR subscribers only.

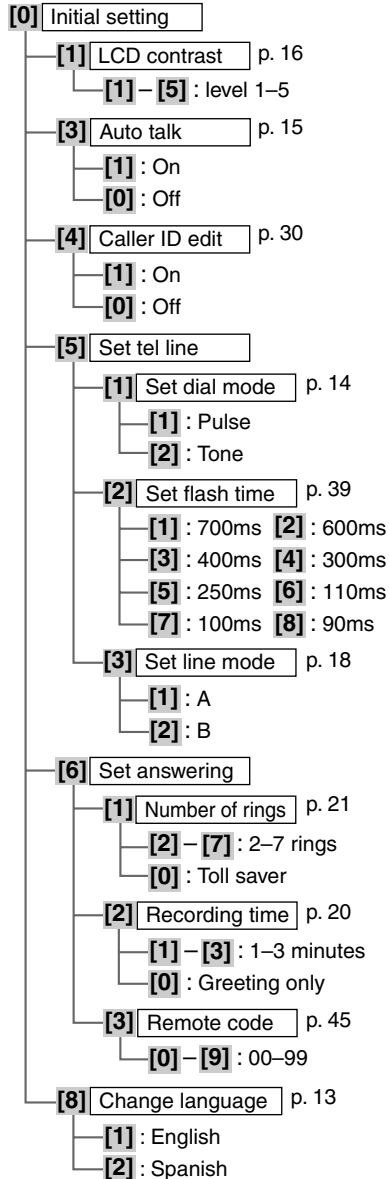

Troubleshooting

Cordless Telephone

Problem	Cause & Remedy
"No link to base. Place on cradle and try again." is displayed and an alarm tone sounds.	<ul style="list-style-type: none">• You are too far from the base unit. Walk closer and try again.• Place the handset on the base unit and try again.• Plug in the AC adaptor.• Raise the base unit antenna.
Static, sound cuts in/out, fades. Interference from other electrical units.	<ul style="list-style-type: none">• Move the handset and the base unit away from other electrical appliances (p. 3).• Walk closer to the base unit.• Raise the base unit antenna.• Select a clearer channel (p. 23, 37).
The handset and/or base unit does not ring.	<ul style="list-style-type: none">• The ringer volume is set to OFF. Set to HIGH, MEDIUM or LOW (p. 17).• When the handset is on the base unit, the handset does not ring. Only the base unit rings when receiving a call.
The handset display is blank.	<ul style="list-style-type: none">• Charge the battery fully (p. 8).
You cannot program function items.	<ul style="list-style-type: none">• Programming is not possible while the unit is being used.• Do not pause for over 60 seconds while programming.• Walk closer to the base unit.
While programming or searching, the unit starts to ring and stops the program/search.	<ul style="list-style-type: none">• A call is coming in. To answer the call, press [hook] or [4]. Start again from the beginning after hanging up.
You cannot make a call with the handset.	<ul style="list-style-type: none">• Your handset is in remote operation mode (p. 42). Exit by pressing [OFF].
You cannot redial.	<ul style="list-style-type: none">• If the last number dialed was more than 32 digits long, the number will not be redialed correctly.

Troubleshooting

Problem	Cause & Remedy
The unit does not display the caller's name and/or phone number.	<ul style="list-style-type: none"> • You need to subscribe to a Caller ID service. • Other telephone equipment may be interfering with your phone. Disconnect it and try again. • Other electrical appliances connected to the same outlet may be interfering with Caller ID. • Telephone line noise may be affecting Caller ID. • The caller requested not to send his/her Caller ID information (p. 26). • If a Caller ID box is connected between the unit and the telephone wall jack, disconnect the Caller ID box or plug the unit directly into the wall jack.
The handset display exits the Caller List or phone book.	<ul style="list-style-type: none"> • Do not pause for over 60 seconds while searching.
You cannot page the handset or base unit.	<ul style="list-style-type: none"> • The handset is too far from the base unit. • The handset user is making an outside call, viewing the Caller List/phone book or listening to messages. Wait until the IN USE/CHARGE indicator light goes out. • The handset or base unit is in use. Try again later.
You cannot have a conversation using the headset.	<ul style="list-style-type: none"> • Make sure the optional headset is connected properly (p. 49). • If "SP-phone" is displayed on the handset, press [] to switch to the headset.

Answering System



Problem	Cause & Remedy
The Answering System is on, but incoming messages are not recorded.	<ul style="list-style-type: none"> • The recording time is set to "Greeting only". Select "1 minute", "2 minutes" or "3 minutes" (p. 20). • Memory is full. Erase unnecessary messages (p. 44).
You cannot listen to recorded messages.	<ul style="list-style-type: none"> • Make sure the unit is not being used.
"FULL" is displayed and [ANSWER ON] flashes rapidly. No new messages are recorded.	<ul style="list-style-type: none"> • Memory is full. Erase unnecessary messages (p. 44).

Problem	Cause & Remedy
You cannot operate the Answering System with the base unit.	<ul style="list-style-type: none"> • The handset user is operating the Answering System, or is on the phone. Wait until the IN USE/CHARGE indicator light goes out.
You cannot operate the Answering System from a touch tone phone.	<ul style="list-style-type: none"> • Make sure you enter the correct remote code (p. 45). • The Answering System may not respond if the tones are too short to activate the unit. Press each button firmly. • The Answering System is off. Turn it on (p. 47).
You cannot operate the Answering System with the handset.	<ul style="list-style-type: none"> • Someone is operating the Answering System. • You are too far from the base unit. Walk closer to the base unit. • The unit is recording a message. To answer the call, press [↶] or [↷].
While recording a greeting message, the unit starts to ring and stops recording.	<ul style="list-style-type: none"> • To answer the call, press [↶] or [↷]. Start again from the beginning after hanging up.
During playback, the unit starts to ring and stops playback.	<ul style="list-style-type: none"> • To answer the call, press [↶] or [↷]. To resume playback, press [MESSAGE/SLOW TALK] after hanging up.
Caller ID information is not displayed during message playback (p. 43).	<ul style="list-style-type: none"> • Caller ID information will not be displayed if the Caller List is renewed and the caller ID information is erased (p. 27).

General

Problem	Cause & Remedy
The unit does not work.	<ul style="list-style-type: none"> • Check the settings (p. 8–9). • Check whether the dialing mode setting is correct (p. 14). • Charge the battery fully (p. 8). • Clean the charge contacts and charge again (p. 9). • Install the battery properly (p. 8). • Place the handset on the base unit and unplug the AC adaptor to reset it. Plug in, and try again. • Re-install the battery (p. 8) and charge it fully.

Troubleshooting

Problem	Cause & Remedy
Previously programmed information is erased.	<ul style="list-style-type: none">• If a power failure occurs, programmed information may be erased. Reprogram if necessary.
"Recharge battery" is displayed, "  " flashes or the unit beeps intermittently.	<ul style="list-style-type: none">• Charge the battery fully (p. 8).
You charged the battery fully, but "Recharge battery" is still displayed and/or "  " continues to flash.	<ul style="list-style-type: none">• Clean the charge contacts and charge again (p. 9).• Install a new battery (p. 8).
The IN USE/CHARGE indicator light does not go out after the battery has been charged.	<ul style="list-style-type: none">• This is normal.
If you cannot solve your problem	<ul style="list-style-type: none">• Call our customer call center at 1-800-211-PANA(7262).• Panasonic's e-mail address for customer inquiries: consumerproducts@panasonic.com for customers in the USA or Puerto Rico ONLY
When you try to download phone book data or information from openLCR, the voice prompt is not announced from the handset while "Listen & follow phone guidance." is being displayed.	<ul style="list-style-type: none">• Check the settings (p. 8–9).• If you cannot solve a problem, consult openLCR (see below).
For more information about Caller IQ	<ul style="list-style-type: none">• Call openLCR's customer service department at 1-866-openLCR (1-866-673-6527).• openLCR's web site: www.openLCR.com

openLCR Service for Caller IQ Feature

The Caller IQ feature is compatible with service provided by openLCR.

Important:

- If you have any questions regarding the openLCR service, call openLCR's customer service department at 1-866-openLCR (1-866-673-6527).
- NEITHER PANASONIC COMMUNICATIONS CO., LTD. (PCC) NOR MATSUSHITA ELECTRIC CORPORATION OF AMERICA (MECA) IS IN ANY WAY AFFILIATED WITH, OR RESPONSIBLE FOR THE ACTS OR OMISSIONS OF, OPENLCR.COM, INC. (OPENLCR). NEITHER PCC NOR MECA NOR ANY OF THEIR EMPLOYEES OR AFFILIATES OR CUSTOMERS MAKE ANY WARRANTIES OR REPRESENTATIONS, EITHER EXPRESS OR IMPLIED, TO ANY CUSTOMER OR ANY OTHER THIRD PARTY WITH RESPECT TO ANY OF THE SERVICES PROVIDED BY OPENLCR, NOR ASSUME NOR CREATE ANY OTHER OBLIGATION OF ANY KIND ON BEHALF OF OPENLCR.

Setting Caller IQ to OFF and ON Handset

After the first download to your phone, Caller IQ features are automatically turned on. If you wish, you can turn off Caller IQ.

- When Caller IQ is ON, “[CIQ]” is displayed while talking.

To set Caller IQ to OFF (When Caller IQ is ON.)

1 Press **[MENU]**.

2 Scroll to “Caller IQ” by pressing **[V]** or **[^]**, then press **Select**.

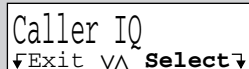

Caller IQ
↓Exit ^\ Select↓

3 Scroll to “Turn CIQ off?” by pressing **[V]** or **[^]**, then press **Yes**.

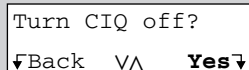

Turn CIQ off?
↓Back ^\ Yes↓

- “Caller IQ off” is displayed.
- If the handset beeps 3 times, Caller IQ is not set to OFF. Start again from step 1.

4 Press **[OFF]**.

To set Caller IQ from OFF to ON

1 Follow steps 1 to 2 of “To set Caller IQ to OFF” above.

2 Press **Yes** at “Turn CIQ on?”.

- “Caller IQ on” is displayed.
- If the handset beeps 3 times, Caller IQ is not set to ON. Start again from step 1.

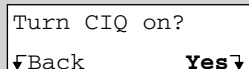

Turn CIQ on?
↓Back Yes↓

3 Press **[OFF]**.

openLCR Service for Caller IQ Feature

Downloading Phone Book Data

To create your phone book, go to the openLCR web site to update your phone book, then download the data to your unit. Accessing the openLCR web site can be done from any computer with Internet access.

- While downloading from openLCR, “ \mathcal{L} ” flashes on the base unit display.

To create phone book data

If you have already stored items into the phone book of the unit, you need to enter all of those stored items on the openLCR web site. Then, add all new items through the openLCR web site.

1 Go to openLCR’s web site at **www.openLCR.com** and click on “Manage Account” tab.

2 Follow the web screen to create the phone book data.

- Make sure to enter a name up to 15 characters, and a phone number up to 32 digits.

• In the case that you stored or created the items in the phone book of the unit, you also need to store or create the items on the web site.

• The description on the openLCR web screen is subject to change without notice.

To download the phone book data from openLCR **Handset**

1 Press [\hookrightarrow] or [\leftarrow], then press [MENU].

2 Press **Yes** within 10 seconds at “Get new CIQ Information?”.

- The unit will dial to openLCR automatically.
- A voice prompt will be heard.

If you live in or move from another area to Fort Collins, Colorado, press [#] before pressing **Yes**.

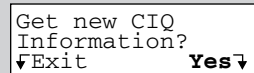

Get new CIQ Information?
↓Exit Yes↓

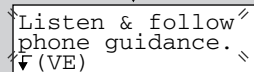

Listen & follow phone guidance.
↓(VE)

3 Follow the voice prompt to start downloading.

- When downloading starts, the display will show the message on the right.
- After downloading starts, the handset must be off-hook. **DO NOT PLACE** the handset on the base unit (placing the handset on the base unit will terminate the download process). **DO NOT PRESS [OFF]** (pressing [OFF] will terminate the download process).

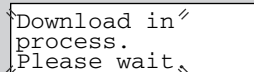

Download in process.
Please wait

4 When downloading is complete, a beep sounds.



[Caller IQ on]
Download OK!

openLCR Service for Caller IQ Feature

- If the handset beeps 3 times and “Download incomplete. Phone book full.” is displayed, some items cannot be stored in the phone book. Store items by following the steps below.
 1. Erase items which do not exist on the web from the phone book of the unit (p. 36).
 2. Access the openLCR web site.
 3. Go to the web screen to create the phone book data.
 4. Click [Download All].
 5. Start again from step 1 (“To download the phone book data from openLCR” on page 56).
- If the handset beeps 3 times and “Download incomplete. Try again.” is displayed, the unit has lost communication with openLCR. Store items by following the steps below.
 1. Access the openLCR web site.
 2. Go to the web screen to create the phone book data.
 3. Click [Download All].
 4. Start again from step 1 (“To download the phone book data from openLCR” on page 56).
- You cannot access the openLCR server if a telephone or fax machine on the same phone line is in use.
- While the unit is downloading the data from openLCR, the Call Waiting Service cannot be used.

Information Download Handset

This enables you to view information such as weather forecast, stock quotes, lottery results, sports scores and horoscopes from the LCD display on your openLCR-ready unit. Each time you download the data from openLCR, the information will be updated. To view up-to-date information, you will need to download it to your unit.

- You can select the items of information on the web site which you want to view.
- Horoscopes are for entertainment purposes only.

To update information

1 Press [MENU].

2 Scroll to “Caller IQ” by pressing [V] or [Λ], then press **Select**.

3 Scroll to “Get new Info.?” by pressing [V] or [Λ], then press **Yes**.

- The unit will dial to openLCR automatically and start downloading information.

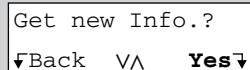

Get new Info.?
↓Back VA Yes↓

If you live in or move from another area to Fort Collins, Colorado, press [#] before pressing **Yes**.

4 When downloading is complete, a beep sounds.



[Caller IQ on]
Download OK!

- To update information after pressing [↶] or [↷], press [MENU]. “Get new CIQ Information?” is displayed. Press **Yes** within 10 seconds, then follow the voice prompt to start downloading.

For assistance, please call openLCR: 1-866-openLCR(1-866-673-6527)

Download from www.Somanuals.com. All Manuals Search And Download.

openLCR Service for Caller IQ Feature

To view information

1 Press **[MENU]**.

2 Scroll to “Caller IQ” by pressing **[V]** or **[^]**, then press **Select**.

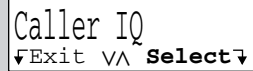

Caller IQ
↓Exit V^ **Select**↓

3 Press **Yes** at “View Info.?”.
• The items of information which you selected on the web are displayed.

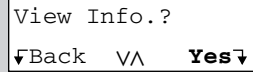

View Info.?
↓Back V^ **Yes**↓

4 Scroll to the desired information by pressing **[V]** or **[^]**.

- You can also select the desired information by pressing dialing buttons.

5 When finished, press **[OFF]** or place the handset on the base unit.

Important Safety Instructions

When using this unit, basic safety precautions should always be followed to reduce the risk of fire, electric shock, or personal injury.

1. Read and understand all instructions.
2. Follow all warnings and instructions marked on this unit.
3. Unplug this unit from AC outlets before cleaning. Do not use liquid or aerosol cleaners. Use a damp cloth for cleaning.
4. Do not use this unit near water, for example, near a bathtub, washbowl, kitchen sink, or the like.
5. Place this unit securely on a stable surface. Serious damage and/or injury may result if the unit falls.
6. Do not cover slots and openings on the unit. They are provided for ventilation and protection against overheating. Never place the unit near radiators, or in a place where proper ventilation is not provided.
7. Use only the power source marked on the unit. If you are not sure of the type of power supplied to your home, consult your dealer or local power company.
8. Do not place objects on the power cord. Install the unit where no one can step or trip on the cord.
9. Do not overload wall outlets and extension cords. This can result in the risk of fire or electric shock.
10. Never push any objects through slots in this unit. This may result in the risk of fire or electric shock. Never spill any liquid on the unit.
11. To reduce the risk of electric shock, do not disassemble this unit. Take the unit to an authorized servicer when service is required. Opening or removing covers may expose you to dangerous voltages or other risks. Incorrect reassembly can cause electric shock when the unit is subsequently used.
12. Unplug this unit from the wall outlet and refer servicing to an authorized servicer when the following conditions occur:
 - A. When the power supply cord or plug is damaged or frayed.
 - B. If liquid has been spilled into the unit.
 - C. If the unit has been exposed to rain or water.
 - D. If the unit does not work normally by following the operating instructions. Adjust only controls covered by the operating instructions. Improper adjustment may require extensive work by an authorized servicer.
 - E. If the unit has been dropped or physically damaged.
 - F. If the unit exhibits a distinct change in performance.
13. During thunderstorms, avoid using telephones except cordless types. There may be a remote risk of an electric shock from lightning.
14. Do not use this unit to report a gas leak, when in the vicinity of the leak.

SAVE THESE INSTRUCTIONS

For assistance, please call: 1-800-211-PANA(7262)

Download from www.Somanuals.com. All Manuals Search And Download.

Important Safety Instructions

CAUTION:

To reduce the risk of fire or injury to persons, read and follow these instructions.

1. Use only the battery(ies) specified.
2. Do not dispose of the battery(ies) in a fire. They may explode. Check with local waste management codes for special disposal instructions.
3. Do not open or mutilate the battery(ies). Released electrolyte is corrosive and may cause burns or injury to the eyes or skin. The electrolyte may be toxic if swallowed.
4. Exercise care in handling batteries in order not to short the battery to conductive materials such as rings, bracelets, and keys. The battery and/or conductor may overheat and cause burns.
5. Charge the battery(ies) provided with or identified for use with this product only in accordance with the instructions and limitations specified in this manual.

WARNING:

TO PREVENT FIRE OR SHOCK HAZARD, DO NOT EXPOSE THIS PRODUCT TO RAIN OR ANY TYPE OF MOISTURE.

- The AC adaptor is used as the main disconnect device, ensure that the AC outlet is located/installed near the unit and is easily accessible.

FCC and Other Information

This equipment complies with Part 68 of the FCC rules and the requirements adopted by the ACTA. On the bottom of this equipment is a label that contains, among other information, a product identifier in the format US:ACJ-----. If requested, this number must be provided to the telephone company.

Registration No. (found on the bottom of the unit)
Ringer Equivalence No. (REN) 0.1B

A plug and jack used to connect this equipment to the premises wiring and telephone network must comply with the applicable FCC Part 68 rules and requirements adopted by the ACTA. A compliant telephone cord and modular plug is provided with this product. It is designed to be connected to a compatible modular jack that is also compliant.

The REN is used to determine the number of devices that may be connected to a telephone line. Excessive RENs on a telephone line may result in the devices not ringing in response to an incoming call. In most but not all areas, the sum of RENs should not exceed five (5.0). To be certain of the number of devices that may be connected to a line, as determined by the total RENs, contact the local telephone company. For products approved after July 23, 2001, the REN for this product is part of the product identifier that has the format US:AAAEQ##TXXXX. The digits represented by ## are the REN without a decimal point (e.g., 03 is a REN of 0.3).

If this equipment causes harm to the telephone network, the telephone company will notify you in advance that temporary discontinuance of service may be required. But if advance notice isn't practical, the telephone company will notify the customer as soon as possible. Also, you will be advised of your right to file a complaint with the FCC if you believe it is necessary.

The telephone company may make changes in its facilities, equipment, operations or procedures that could affect the operation of the equipment. If this happens the telephone company will provide advance notice in order for you to make necessary modifications to maintain uninterrupted service.

If trouble is experienced with this equipment, for repair or warranty information, please contact a Factory Servicenter or other Authorized Servicer. If the equipment is causing harm to the telephone network, the telephone company may request that you disconnect the equipment until the problem is resolved.

Connection to party line service is subject to state tariffs. Contact the state public utility commission, public service commission or corporation commission for information.

If your home has specially wired alarm equipment connected to the telephone line, ensure the installation of this equipment does not disable your alarm equipment. If you have questions about what will disable alarm equipment, consult your telephone company or a qualified installer.

WHEN PROGRAMMING EMERGENCY NUMBERS AND(OR) MAKING TEST CALLS TO EMERGENCY NUMBERS:

- 1) Remain on the line and briefly explain to the dispatcher the reason for the call.
- 2) Perform such activities in the off-peak hours, such as early morning or late evenings.

For assistance, please call: 1-800-211-PANA(7262)

Download from www.Somanuals.com. All Manuals Search And Download.

FCC and Other Information

This device complies with Part 15 of the FCC Rules. Operation is subject to the following two conditions: (1) This device may not cause harmful interference, and (2) this device must accept any interference received, including interference that may cause undesired operation.

Privacy of communications may not be ensured when using this phone.

CAUTION:

Any changes or modifications not expressly approved by the party responsible for compliance could void the user's authority to operate this device.

Note:

This equipment has been tested and found to comply with the limits for a Class B digital device, pursuant to Part 15 of the FCC Rules. These limits are designed to provide reasonable protection against harmful interference in a residential installation. This equipment generates, uses, and can radiate radio frequency energy and, if not installed and used in accordance with the instructions, may cause harmful interference to radio communications. However, there is no guarantee that interference will not occur in a particular installation. If this equipment does cause harmful interference to radio or television reception, which can be determined by turning the equipment off and on, the user is encouraged to try to correct the interference by one or more of the following measures:

- Reorient or relocate the receiving antenna.
- Increase the separation between the equipment and receiver.
- Connect the equipment into an outlet on a circuit different from that to which the receiver is connected.
- Consult the dealer or an experienced radio/TV technician for help.

Some cordless telephones operate at frequencies that may cause interference to nearby TVs and VCRs. To minimize or prevent such interference, the base of the cordless telephone should not be placed near or on top of a TV or VCR. If interference is experienced, move the cordless telephone further away from the TV or VCR. This will often reduce, or eliminate, interference.

Operating near 2.4GHz electrical appliances may cause interference. Move away from the electrical appliances and/or press the TALK or SP-PHONE button, or CH (Channel) key.

CAUTION:

To comply with FCC RF exposure requirements, the base unit should be installed with its antenna located at 20 cm or more from persons and handset should be carried with the specific belt-clip provided for the handset to ensure compliance. Other non-tested belt-clips or similar body-worn accessories may not comply, therefore, should be avoided.

This equipment is hearing aid compatible as defined by the FCC in 47 CFR Section 68.316.

When you hold the phone to your ear, noise might be heard in your Hearing Aid. Some Hearing Aids are not adequately shielded from external RF (radio frequency) energy. If noise occurs, use an optional headset accessory or the speakerphone option (if applicable) when using this phone. Consult your audiologist or Hearing Aid manufacturer about the availability of Hearing Aids which provide adequate shielding to RF energy commonly emitted by digital devices.

A TIA/EIA-IS-968 compliant telephone cord and modular plug is provided with this equipment. This equipment is designed to be connected to the telephone network or premises wiring using a compatible modular jack that is also TIA/EIA-IS-968 compliant.

The software contained in this equipment to allow user access to the network must be ungraded to recognize newly established network area codes and exchange codes as they are placed into service.

Failure to upgrade the premises systems or peripheral equipment to recognize the new codes as they are established will restrict the customer and the customer's employees from gaining access to the network and to these codes.

- **Environment** — do not place the unit in a room where the temperature is less than 5°C (41°F) or greater than 40°C (104°F). Allow 10 cm (4") clearance around the unit for proper ventilation. Avoid excessive smoke, dust, mechanical vibration, shock, or direct sunlight.
- **Medical** — consult the manufacturer of any personal medical devices, such as pacemakers, to determine if they are adequately shielded from external RF (radio frequency) energy. (The unit operates in the frequency range of 2402MHz to 2480MHz, and the power output level can range 0.01 watts.) Do not use the unit in health care facilities if any regulations posted in the area instruct you not to do so. Hospitals or health care facilities may be using equipment that could be sensitive to external RF (radio frequency) energy.
- **Routine care** — wipe the unit with a soft cloth. Do not use benzine, thinner, or any abrasive powder. When you leave the unit unused for a long period of time, unplug the AC adaptor from the outlet.
- **If there is any trouble** — disconnect the unit from the telephone line and connect a known working phone. If the known working phone operates properly, have your unit repaired by one of the authorized Panasonic Factory Service Centers. If the known working phone does not operate properly, consult your telephone company.

Specifications

■ Base unit

Power Supply:	AC Adaptor (120 V AC, 60 Hz)
Power Consumption:	Standby: Approx. 2.6 W Maximum: Approx. 3.9 W
Frequency:	2.402 GHz – 2.480 GHz
Dimensions (H x W x D):	Approx. 104 mm x 148 mm x 173 mm (4 ³ / ₃₂ " x 5 ²⁷ / ₃₂ " x 6 ¹³ / ₁₆ ")
Mass (Weight):	Approx. 360 g (0.79 lb.)

■ Handset

Power Supply:	Ni-MH battery (2.4 V, 1,500 mAh)
Frequency:	2.402 GHz – 2.480 GHz
Dimensions (H x W x D):	Approx. 246 mm x 52 mm x 41 mm (9 ¹¹ / ₁₆ " x 2 ¹ / ₁₆ " x 1 ⁵ / ₈ ")
Mass (Weight):	Approx. 210 g (0.46 lb.)
Security Codes:	1,000,000

■ **Dialing Mode:** Tone (DTMF)/Pulse

■ **Operating Environment:** 5 °C – 40 °C (41 °F – 104 °F)

Specifications are subject to change without notice.

For your future reference

Serial No. _____ Date of purchase _____
(found on the bottom of the unit)

Name and address of dealer _____

PANASONIC CONSUMER
ELECTRONICS COMPANY, DIVISION
OF MATSUSHITA ELECTRIC
CORPORATION OF AMERICA
One Panasonic Way
Secaucus, New Jersey 07094

PANASONIC SALES COMPANY,
DIVISION OF MATSUSHITA
ELECTRIC OF PUERTO RICO, INC.,
Ave. 65 de Infanteria, Km. 9.5
San Gabriel Industrial Park
Carolina, Puerto Rico 00985

Panasonic Telephone Products Limited Warranty

Limited Warranty Coverage

If your product does not work properly because of a defect in materials or workmanship, Panasonic Consumer Electronics Company or Panasonic Sales Company (collectively referred to as "the warrantor") will, for the length of the period indicated on the chart below, which starts with the date of original purchase ("warranty period"), at its option either (a) repair your product with new or refurbished parts, or (b) replace it with a new or a refurbished product. The decision to repair or replace will be made by the warrantor.

Parts	Labor
One (1) Year	One (1) Year

During the "Labor" warranty period there will be no charge for labor. During the "Parts" warranty period, there will be no charge for parts. You must mail-in your product during the warranty period. This Limited Warranty excludes both parts and labor for batteries, antennas, and cosmetic parts (cabinet). This warranty only applies to products purchased and serviced in the United States or Puerto Rico. This warranty is extended only to the original purchaser of a new product which was not sold "as is".

Mail-In Service

For assistance in the continental U.S.A. in obtaining repairs please ship the product to:

Panasonic Services Company
Customer Servicerter
Suite B
4900 George McVay Drive
McAllen, TX 78503

For assistance in Puerto Rico call Panasonic Sales Company (787)-750-4300 or fax (787)-768-2910.

When shipping the unit carefully pack and send it prepaid, adequately insured and preferably in the original carton. Include a letter detailing the complaint and provide a day time phone number where you can be reached.

IF REPAIR IS NEEDED DURING THE WARRANTY PERIOD THE PURCHASER WILL BE REQUIRED TO FURNISH A SALES RECEIPT/PROOF OF PURCHASE INDICATING DATE OF PURCHASE, AMOUNT PAID AND PLACE OF PURCHASE. CUSTOMER WILL BE CHARGED FOR THE REPAIR OF ANY UNIT RECEIVED WITHOUT SUCH PROOF OF PURCHASE.

Limited Warranty Limits And Exclusions

This warranty ONLY COVERS failures due to defects in materials or workmanship, and DOES NOT COVER normal wear and tear or cosmetic damage. The warranty ALSO DOES NOT COVER damages which occurred in shipment, or failures which are caused by products not supplied by the warrantor, or failures which result from accidents, misuse, abuse, neglect, mishandling, misapplication, alteration, faulty installation, set-up adjustments, misadjustment of consumer controls, improper maintenance, power line surge, lightning damage, modification, introduction of sand, humidity or liquids, commercial use such as hotel, office, restaurant, or other business or rental use of the product, or service by anyone other than a Factory Servicerter or other Authorized Servicer, or damage that is attributable to acts of God.

THERE ARE NO EXPRESS WARRANTIES EXCEPT AS LISTED UNDER "LIMITED WARRANTY COVERAGE". THE WARRANTOR IS NOT LIABLE FOR INCIDENTAL OR CONSEQUENTIAL DAMAGES RESULTING FROM THE USE OF THIS PRODUCT, OR ARISING OUT OF ANY BREACH OF THIS WARRANTY. (As examples, this excludes damages for lost time, lost calls or messages, cost of having someone remove or re-install an installed unit if applicable, travel to and from the servicer. The items listed are not exclusive, but are for illustration only.) **ALL EXPRESS AND IMPLIED WARRANTIES, INCLUDING THE WARRANTY OF MERCHANTABILITY, ARE LIMITED TO THE PERIOD OF THE LIMITED WARRANTY.**

Some states do not allow the exclusion or limitation of incidental or consequential damages, or limitations on how long an implied warranty lasts, so the exclusions may not apply to you.

This warranty gives you specific legal rights and you may also have other rights which vary from state to state. If a problem with this product develops during or after the warranty period, you may contact your dealer or Servicenter. If the problem is not handled to your satisfaction, then write to the warrantor's Consumer Affairs Department at the addresses listed for the warrantor.

PARTS AND SERVICE, WHICH ARE NOT COVERED BY THIS LIMITED WARRANTY, ARE YOUR RESPONSIBILITY.

Customer Services Directory

For Product Information, Operating Assistance, Literature Request, Dealer Locations, and all Customer Service inquiries please contact: 1-800-211-PANA (7262), Monday-Friday 9 am-9 pm; Saturday-Sunday 9 am-7 pm, EST.

or send e-mail :

consumerproducts@panasonic.com

For hearing or speech impaired TTY users, TTY : 1-877-833-8855

Web Site: <http://www.panasonic.com>

You can purchase parts, accessories or locate your nearest servicenter by visiting our Web Site.

Accessory Purchases:

1-800-332-5368 (Customer Orders Only)

For hearing or speech impaired TTY users, TTY : 1-866-605-1277

Panasonic Services Company 20421 84th Avenue South, Kent, WA 98032

(6 am to 5 pm Monday - Friday; 6 am to 10:30 am Saturday; PST)

(Visa, MasterCard, Discover Card, American Express, Check)

Service in Puerto Rico

***Matsushita Electric of Puerto Rico, Inc. Panasonic Sales Company/
Factory Servicenter:***

***Ave. 65 de Infantería, Km. 9.5, San Gabriel Industrial Park,
Carolina, Puerto Rico 00985***

Phone (787)750-4300 Fax (787)768-2910

Index

A		G	
Accessories	2	Greeting Message	19
Answer setting	40	H	
Answering Calls	25	Headset, optional	49
Auto Talk	15, 25	Hold.	23
Automatic Security Code Setting	38	I	
B		Information Download	57
Backlit LCD	24	Installation, AC adaptor	8
Base Unit Location	3	Installation, Battery	8
Battery Charge	3, 8	Installation, Telephone Line Cord	8
Battery information	9	Intercom call	37
Battery replacement	9	Intercom paging	37
Battery strength	9	L	
Belt Clip	48	LCD Contrast	16
C		Lighted handset keypad	24
Call Waiting Caller ID	38	Line Mode	18
Call Waiting Tone	38	Listening to Messages	41, 42, 43
Caller ID Number Auto Edit Feature	30	Location of Controls	6, 7
Caller ID service	13, 26	M	
Caller IQ service	55	Making Calls	22, 23
Caller List, editing	29	Message storage	20
Caller List, erasing	32	Microphone, Base Unit	19, 37
Caller List, storing	31	Microphone, Handset	22
Caller List, viewing	27	MUTE	38
Calling Back from the Caller List	28	N	
Channel (CH)	23, 37, 42	Navigator key	7
Command menu	47	Noise	3
D		Number of Rings	21
Date and Time	12	O	
Dialing Mode	14	openLCR	55
Display Language	13	P	
E		PAUSE	39
Erasing a message	44, 47	Phone Book, dialing	35
Erasing all messages	44, 47	Phone Book, downloading	56
F		Phone Book, editing	36
FCC and Other Information	61	Phone Book, erasing	36
FLASH Button	39	Phone Book, name	34
Flash time	39	Phone Book, storing	33
Function Menu, Direct Commands	50	Power failure	8, 12, 20
Function Menu, Selection	10	Pulse service	38
Function Menu, Table	11		

Index

R

Recording Time	20
Redial	23
Redial list	23
Remote Code	45
Remote Operation, Handset	42
Remote Operation, Touch Tone Phone	45
Ringer Off	17
Ringer Tone	18
Ringer Volume	17
Rotary service, Tone dialing	38

S

Safety Instructions	59
Shipping product for service	71
Shoulder Rest Attachment	49
Slow Talk message playback	43, 47
Soft keys	7
Specifications	64
SP-phone	22

T

Toll saver	21
Troubleshooting, Answering System	52
Troubleshooting, Cordless telephone	51
Troubleshooting, General	53

V

Voice Enhancer Technology	14
Voice menu	42, 46
Volume control, Base Unit	19, 37, 43
Volume control, Handset	24, 43

W

Wall Mounting	48
Warranty	65

For product service

- Call 1-800-211-PANA(7262) for the location of an authorized servicer.
- Panasonic's e-mail address for customer inquiries:
consumerproducts@panasonic.com
for customers in the USA or Puerto Rico ONLY

When you ship the product

- Carefully pack your unit, preferably in the original carton.
- Attach a letter, detailing the symptom, to the outside of the carton.

Symptom

- Send the unit to an authorized servicer, prepaid and adequately insured.
- Do not send your unit to the Panasonic Consumer Electronics Company listed on the back cover or to executive or regional sales offices. These locations do not repair consumer products.

- This cordless telephone is designed for use in the United States of America. Sale or use of this product in other countries may violate local laws.
- Ce téléphone sans fil est conçu pour être utilisé aux États-Unis d'Amérique. La vente ou l'emploi de cet appareil dans certains autres pays peut constituer une infraction à la législation locale.
- Este teléfono sin cordón fue elaborado para uso en los Estados Unidos de América. La venta o el empleo de este producto en ciertos países puede constituir violación de la legislación local.
- このコードレス電話機は、日本国外での使用を目的として設計されており、日本国内での使用は法律違反となります。従って、当社では日本国内においては原則として修理などのサービスは致しかねます。

**If you need assistance with the set-up or operation,
please call 1-800-211-PANA(7262)**

**Panasonic Consumer Electronics Company,
Division of Matsushita Electric Corporation of America**
One Panasonic Way, Secaucus, New Jersey 07094

**Panasonic Sales Company,
Division of Matsushita Electric of Puerto Rico, Inc.**
Ave. 65 de Infantería, Km. 9.5, San Gabriel Industrial Park
Carolina, Puerto Rico 00985

Free Manuals Download Website

<http://myh66.com>

<http://usermanuals.us>

<http://www.somanuals.com>

<http://www.4manuals.cc>

<http://www.manual-lib.com>

<http://www.404manual.com>

<http://www.luxmanual.com>

<http://aubethermostatmanual.com>

Golf course search by state

<http://golfingnear.com>

Email search by domain

<http://emailbydomain.com>

Auto manuals search

<http://auto.somanuals.com>

TV manuals search

<http://tv.somanuals.com>