

# Panasonic

5.8 GHz Expandable Cordless Answering System

## Operating Instructions

Model No. **KX-TG5240AL**



The unit is Caller ID compatible. To display the caller's phone number, you must subscribe to Caller ID service.

**PLEASE READ BEFORE USE AND SAVE.**

**Charge the battery for 6 hours before initial use.**

**Thank you for purchasing your new Panasonic cordless telephone.**

When you subscribe to Caller ID services from your telephone operator, this telephone will display the caller's phone number. When available from your telephone operator, this telephone will also display the number of the second call or call waiting.

**For your future reference**





Serial No. \_\_\_\_\_ Date of purchase \_\_\_\_\_

(found on the bottom of the unit)

Name and address of dealer \_\_\_\_\_

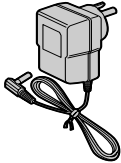
Attach or keep original receipt to assist with any repair under warranty.

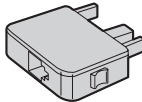
**Accessories (included)**

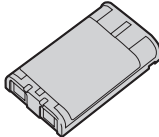
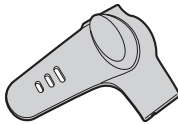
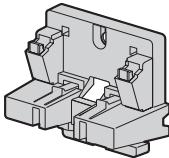
<input type="checkbox"/> AC Adaptor (p. 12)  one	<input type="checkbox"/> Telephone Line Cord (p. 12)  one	<input type="checkbox"/> Telephone Plug (p. 12)  one
<input type="checkbox"/> Handset Cover (p. 13)  one	<input type="checkbox"/> Battery (p. 13)  one	<input type="checkbox"/> Belt Clip (p. 77)  one
<input type="checkbox"/> Wall Mounting Adaptor (p. 78)  one		

## Expanding Your Phone

KX-TG5240AL includes one handset and one base unit. You can expand the system by adding up to 3 accessory handsets, sold separately. A maximum of 4 handsets can be registered to the base unit.

The model number of the accessory handset is KX-TGA520AL. A charger is included with each accessory handset.

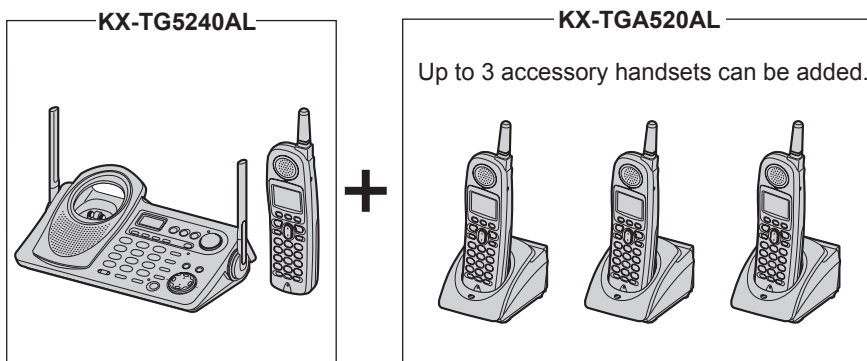

The included handset is pre-registered at the factory and assigned the extension number 1. After purchasing accessory handsets, you must register each to the base unit. (Please read the accessory handset's Installation Manual.)

# Contents

<b>Preparation</b>	
<b>For Best Performance</b>	<b>6</b>
<b>Location of Controls</b>	<b>7</b>
<b>Displays</b>	<b>10</b>
<b>Installation</b>	<b>12</b>
Connections	12
Installing the Battery in the Handset	13
Battery Charge	13
<b>Programmable Settings</b>	<b>15</b>
Programming Guidelines	15
Function Menu Table	16
Date and Time	17
Ringer Volume	18
Ringer Tone	19
Auto Talk	21
LCD Contrast	21
Storing Your Area Code	22
Line Mode	23
Dialling Mode	23
<b>Preparing the Answering System</b>	<b>24</b>
Greeting Message	24
Caller's Recording Time	26
Number of Rings	27
Recording Mode	28
Message Alert	28
<b>Telephone System</b>	
<b>Making Calls</b>	<b>29</b>
Using the Handset	29
Using the Base Unit	32
<b>Answering Calls</b>	<b>33</b>
<b>Caller ID Service</b>	<b>34</b>
Talking Caller ID	35

<b>Using the Caller List</b>	<b>37</b>
Viewing the Caller List	37
Calling Back from the Caller List	38
Editing the Caller's Phone Number	39
Storing Caller Information in the Phone Book	40
Erasing Caller Information	40
<b>Phone Book</b>	<b>41</b>
Storing Names and Numbers	41
Dialling from the Phone Book	43
Chain Dial	44
Editing an Item in the Phone Book	45
Erasing an Item in the Phone Book	45
Copying Items in the Phone Book	46
<b>Speed Dialler</b>	<b>48</b>
Storing Phone Numbers	48
Dialling a Stored Phone Number	48
<b>Intercom</b>	<b>49</b>
Making Intercom Calls	49
Answering Intercom Calls	50
Voice Paging	51
<b>Transferring a Call</b>	<b>52</b>
<b>Conference Calls</b>	<b>55</b>
Call Share	55
<b>Room Monitor</b>	<b>56</b>
<b>Special Features</b>	<b>58</b>
Muting Your Conversation	58
Call Privacy	58
Using the PAUSE Button (For PBX Line/Long Distance Calls)	58

## Contents

Key Tone . . . . .	59	<b>Useful Information</b>
Call Waiting and Caller ID Compatible . . . . .	59	
RECALL Button . . . . .	60	
Incoming Call Tone . . . . .	61	
Dial Lock . . . . .	62	
<b>Answering System</b>		
<b>Mailbox Features</b> . . . . .	64	<b>Preparation</b>
Setting the Mailbox Password (for Mailbox 2 and 3) . . . . .	65	
<b>Automatic Answering Operation</b> . . . . .	66	
Setting the Unit to Answer Calls . . . . .	66	
Monitoring Incoming Calls . . . . .	66	<b>Telephone System</b>
<b>Listening to Messages</b> . . . . .	67	
Using the Base Unit . . . . .	67	
Using the Handset (Remote Operation) . . . . .	68	
<b>Erasing Messages</b> . . . . .	70	<b>Answering System</b>
<b>Recording a Memo Message</b> . . . . .	71	
<b>Transferring a Call to a Mailbox</b> . . . . .	72	
<b>Remote Operation from a Touch Tone Phone</b> . . . . .	73	
Remote Code . . . . .	74	<b>Useful Information</b>
Voice Menu . . . . .	75	
Direct Remote Operation . . . . .	76	
		<b>Useful Information</b>
		<b>Important Information</b>
		<b>Handset</b>
		<b>Base Unit</b>
		<b>Handset Base Unit</b>
		<b>Handset &amp; Base Unit</b>

**Important**

Throughout these Operating Instructions, **Handset** and **Base Unit** are used to indicate with which unit an operation can be performed.

**Handset** : Perform with the handset.

**Base Unit** : Perform with the base unit.

**Handset Base Unit** : Perform with the handset and base unit separately.

**Handset & Base Unit** : Perform with the handset and base unit together.

## For Best Performance

### Battery charge

The handset is powered by a rechargeable Nickel-Metal Hydride (Ni-MH) battery. Charge the battery for **6 hours** before initial use (p. 13).

- **As preventative maintenance, clean the handset and base unit charge contacts with a soft, dry cloth once a month. Clean more often if the unit is subject to grease, dust or high humidity.** Otherwise the battery may not charge properly.



### Base unit location/Noise

Calls are transmitted between the base unit and handset using wireless radio waves. **For maximum distance and noise-free operation**, the recommended base unit location is:

Away from electrical appliances such as a TV, personal computer, cellular phone charging units or another cordless phone.

In a HIGH and CENTRAL location with no obstructions such as walls.

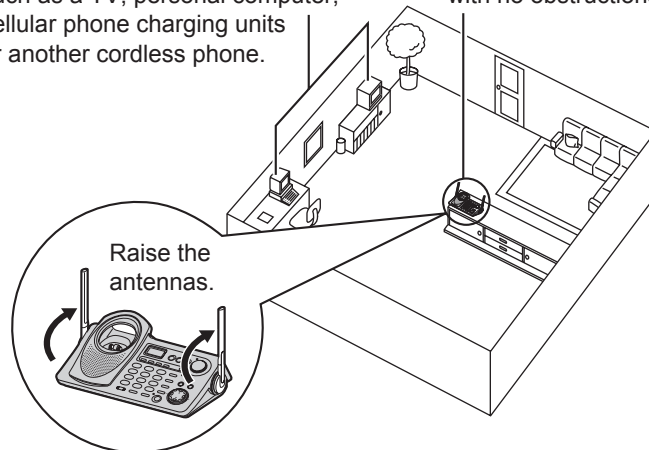

#### Note:

- If you use the handset near a microwave oven which is being used, noise may be heard from the receiver or the speaker. Move away from the microwave oven and closer to the base unit.
- If you use the handset near another cordless phone's base unit, noise may be heard. Move away from the other cordless phone's base unit and closer to your base unit.

# Location of Controls

## Base unit

Preparation

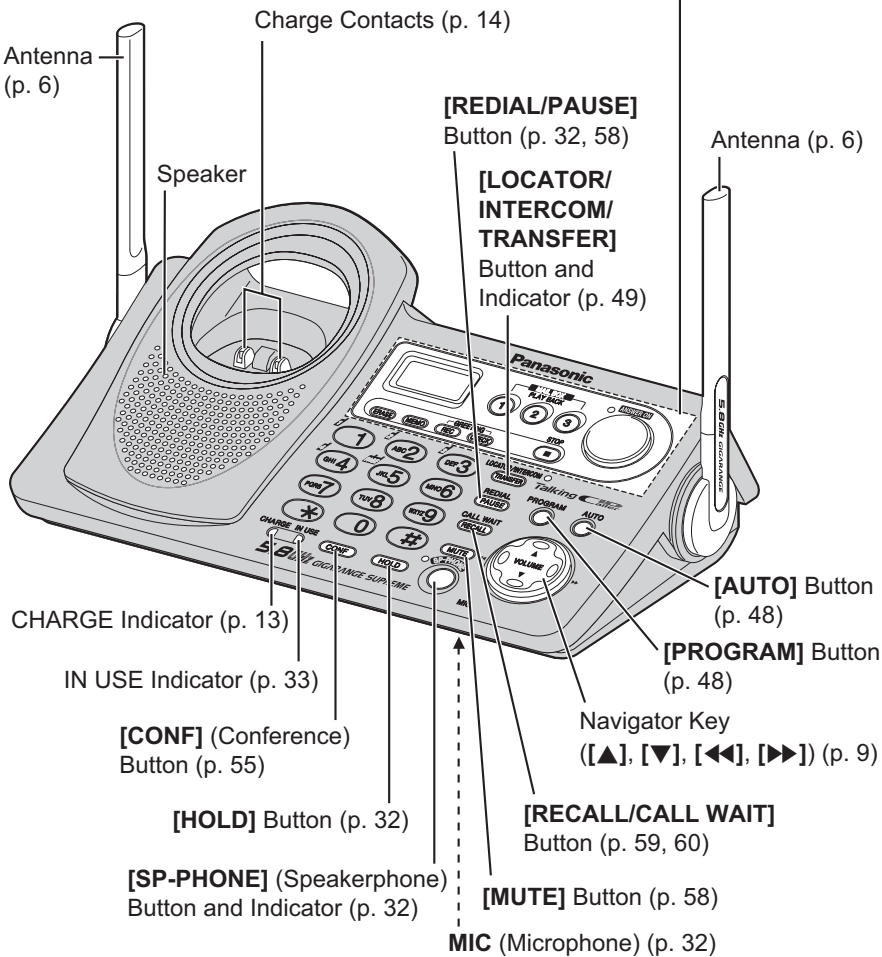
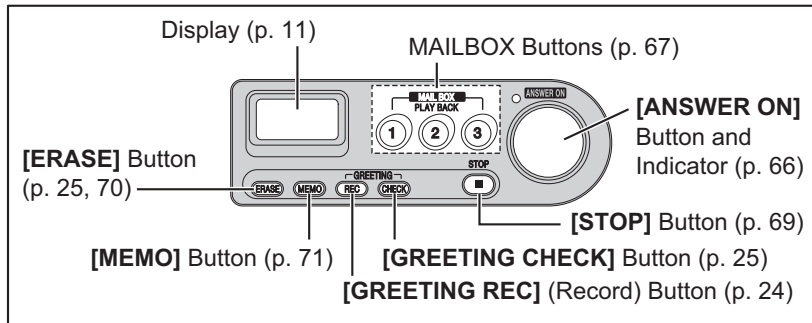

## Location of Controls

### Handset

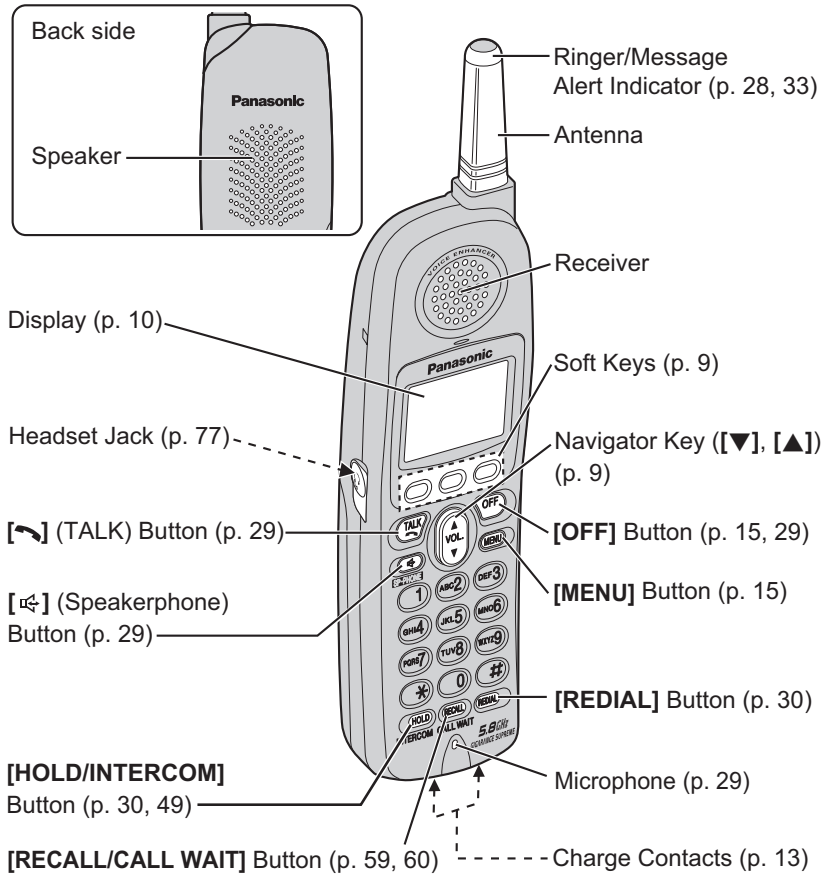





## Location of Controls

### How to use the soft keys/navigator keys

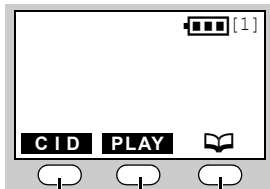
#### Handset soft keys



Three soft keys are used to select functions displayed directly above each key. Functions displayed above each key will change depending on the state of use.

On this sample display, “**CID**”, “**PLAY**” and “” are displayed above the soft keys.

Pressing the right soft key selects the Phone Book “”.

Pressing the middle soft key selects message playback “**PLAY**”.



Pressing the left soft key reviews Caller ID information in the Caller List “**CID**”.



- When a function name does not appear above a soft key, the soft key has no function.



Throughout these Operating Instructions, the soft keys are indicated by their icons, such as **CID**, **PLAY** and .

#### Handset navigator key





Scrolls up [] and down [] the function menu, the Caller List and the phone book.

Increases [] or decreases [] the handset ringer and receiver/speaker volumes.

Throughout these Operating Instructions, the handset navigator key is indicated by the arrows [] or [].

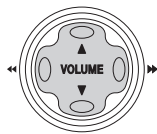



#### Base unit navigator key



Increases [] or decreases [] the base unit ringer and speaker volumes.

Selects the base unit ringer tone [] and [].

Repeats [] or skips [] recorded messages.

Throughout these Operating Instructions, the base unit navigator key is indicated by the arrows [], [], [] or [].

# Displays

## Handset

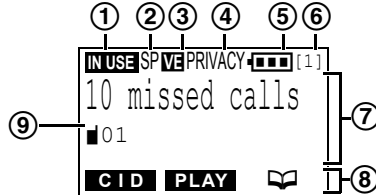

① "IN USE" functions as follows.

Off (invisible)	The line is free.
On	The line is being used.
Flashing	A call is on hold on the handset or base unit, or the Answering System is answering a call (p. 66).
Flashing rapidly	A call is being received.

- ② "SP" is shown when you are using the handset speakerphone.
- ③ "VE" indicates Voice Enhancer mode is on (p. 31).
- ④ "PRIVACY" indicates Call Privacy mode is on (p. 58). Other extension users cannot join your conversation.
- ⑤ The battery icon indicates battery strength (p. 13).
- ⑥ The extension number of your handset is displayed if it has been registered to the base unit (p. 3, 83, 84).
- ⑦ The display shows the dialed number, call status, programming options, phone book items, Caller ID information, etc.
- ⑧ The icons on the bottom line indicate the functions of the corresponding soft keys which are located directly below the display (p. 9).  
Ex. The soft key below "☰" (phone book icon) is used when storing or viewing phone book items (p. 41, 43).
- ⑨ "■" (extension icon) and extension numbers are displayed (ex. base unit="0", handset 1="1")
  - a) during an intercom call (p. 49) or a conference call (p. 55);
  - b) while monitoring a room (p. 57).

## Displays

### Base unit

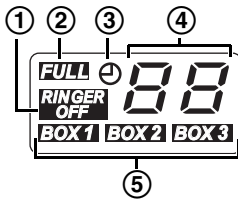

- ① “**RINGER OFF**” indicates the base unit ringer is off (p. 19).
- ② “**FULL**” flashes when no new messages can be recorded. Erase unnecessary messages (p. 70).
- ③ “**RINGER OFF**” flashes until you set the date and time, and flashes after a power failure. If it is flashing, set the date and time (p. 17).

- ④ Message counter shows:
  - the total number of recorded messages in all mailboxes. If the recording time is set to “Greeting only”, “**99**” will be displayed (p. 26).
  - the selected volume level while you are adjusting the speaker volume (p. 25, 32).
  - “**P**” when [**PROGRAM**] is pressed to store a phone number (p. 48).
  - “**E**” when your greeting message or memo message was not recorded correctly (p. 24, 71).
- ⑤ If there are new messages in a mailbox, its icon will flash. If there are only old messages, the icon will be lit. If there are no messages in a mailbox, its icon will not be shown.

Preparation

# Installation

## Connections

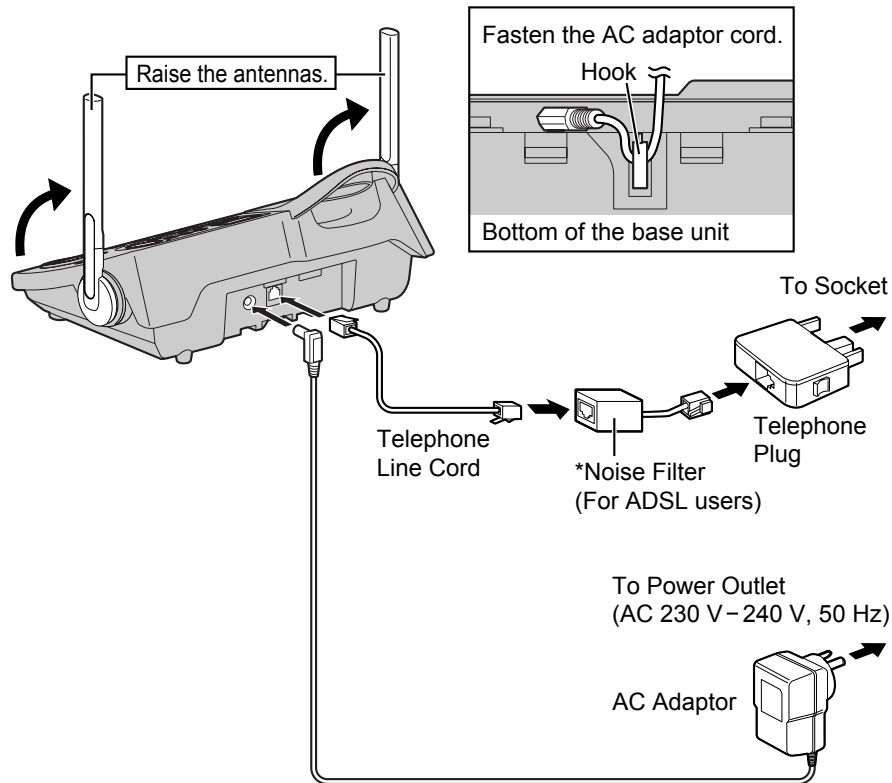

- USE ONLY WITH Panasonic AC ADAPTOR PQLV1AL.
- The AC adaptor must remain connected at all times. (It is normal for the adaptor to feel warm during use.)
- If your unit is connected to a PBX which does not support Caller ID, you cannot access Caller ID services.
- This unit will not function during a power failure. We recommend connecting a standard telephone to the same telephone line or to the same telephone jack using a telephone double adaptor.
- KX-TG5240AL is not designed to be used with rotary (pulse dialling) services.
- \* If the unit is connected to a telephone line with ADSL service, you may hear noise from the receiver or speaker during conversations or the unit may not display caller's phone number properly. We recommend connecting a noise filter (contact your ADSL service provider) to the telephone line between the base unit and the telephone line jack.

## Installation

### Installing the Battery in the Handset

Insert the battery (①), and press it down until it snaps into the compartment (②). Close the cover.

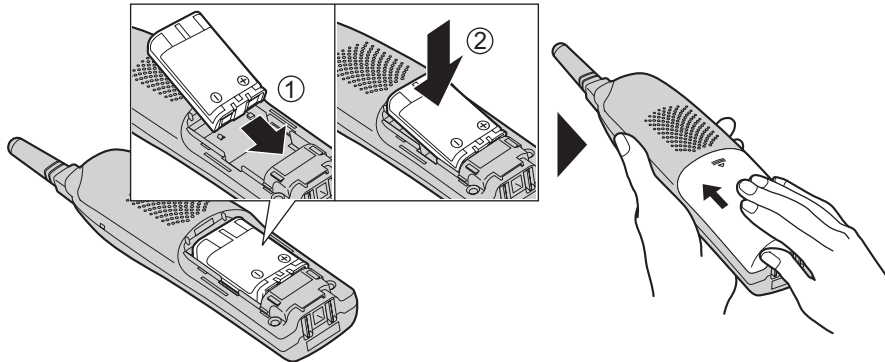

Preparation

#### To replace the battery:

Press the notch on the cover firmly and slide it as indicated by the arrow. Replace the old battery with a new one (p. 14). Close the cover and charge the handset for 6 hours.

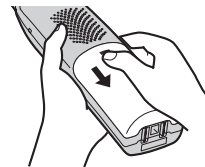

### Battery Charge

Place the handset on the base unit for **6 hours** before initial use.

- The unit beeps once, the CHARGE indicator lights and "Charging" is displayed.
- When the battery is fully charged, "Charge completed" is displayed if there are no new calls in the Caller List.



CHARGE Indicator

### Battery strength

You can confirm the battery strength on the handset display. Battery strength is indicated by the icons shown in the chart to the right.

Display prompt	Battery strength
	Fully charged
	Medium
	Low
	Needs to be recharged.
	Discharged



## Installation

### Recharge

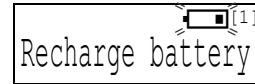

Recharge the battery when:

- “Recharge battery” is displayed on the handset,
- “” flashes, or
- the handset beeps intermittently while it is in use.



- The display will continually indicate “Recharge battery” and/or “” will flash when the handset battery is charged for less than 15 minutes and the handset is lifted off the base unit.
- If the battery has been discharged, the handset will display “Charge for 6 HRS” and “” when you place the handset on the base unit. The handset will not work unless the battery is charged. Continue charging.

#### Battery replacement:

If you cleaned the charge contacts and fully charged the battery, but after a few telephone calls, “Recharge battery” is displayed and/or “” continues to flash, or “Charge for 6 HRS” and “” are displayed, the battery may need to be replaced. Please replace with a new Panasonic HHR-P104 battery. To replace the battery, see page 13.

### Battery information

After your Panasonic battery is fully charged, you can expect the following performance:

Operation	Operating time
While in use (TALK)	Up to 5 hours
While not in use (Standby)	Up to 11 days
While using the Clarity Booster feature (p. 31)	Up to 3 hours

- A fully charged battery will give you up to 5 hours of continuous talk time, or keep your handset in Standby mode to receive incoming calls for up to 11 days (if no phone calls are made). Battery power is consumed whenever the handset is off of the base unit, even when the handset is not in use. The longer you leave the handset off of the base unit, the time you can actually talk on the handset will be shortened. Actual battery performance depends on a combination of how often the handset is in TALK mode and how often it is in Standby mode.
- **As preventative maintenance, clean the handset and base unit charge contacts with a soft, dry cloth once a month. Clean more often if the unit is subject to grease, dust or high humidity.** Otherwise the battery may not charge properly.
- If the battery is fully charged, you do not have to place the handset on the base unit until “Recharge battery” is displayed and/or “” flashes. This will maximize the battery life.
- If you want to keep the battery fully charged at all times, place the handset on the base unit when the handset is not used. The battery cannot be overcharged.
- When the Clarity Booster feature is turned on automatically or manually, battery operating time may be shortened (p. 31).

# Programmable Settings

## Programming Guidelines **Handset**

The unit has several programmable functions which can be selected from the function menu on the display (p. 16).

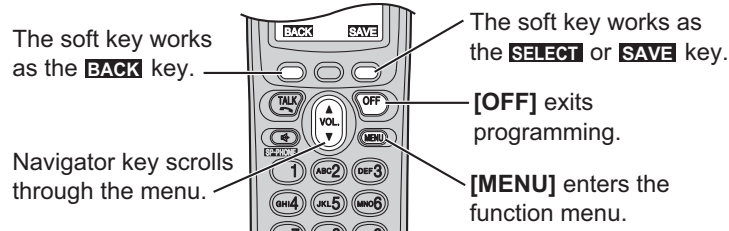

Preparation

### How to select a function item from the menu

**Make sure the handset and base unit are not being used. The handset must be operated near the base unit and while off the base unit.**

**1** Press **[MENU]**.

- The main menu is displayed (p. 16).

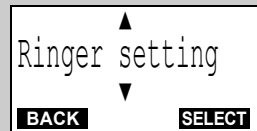

**2** Scroll to the desired item by pressing **[▼]** or **[▲]**.

**3** Press the soft key (**SELECT**) to select the desired item.

- 4** If the item has a sub-menu, select the menu item (p. 16). Repeat steps 2 and 3 until the desired item is displayed. If the item has no sub-menu, go to step 5.

**5** Select the desired setting by pressing **[▼]** or **[▲]**, then press the soft key (**SAVE**).

- A confirmation tone will be heard and the setting will be saved.

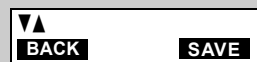

**6** Press **[OFF]** to exit programming mode.

- To go back to the previous menu, press the soft key (**BACK**), or press the soft key (**SELECT**) while "--- (Go back) ---" is displayed. If you press this key in the main menu, the unit will exit programming mode.
- After programming is complete, the display will return to the main menu or the sub-menu depending on which menu the selected item is located. (See the menu table on page 16.)
- You can exit programming mode at any time by pressing **[OFF]**.
- If you do not press any buttons for 60 seconds, the unit will exit programming mode.
- If the unit detects a problem, an error message will be displayed (p. 85–87) and/or error beeps will sound.

## Programmable Settings

### Function Menu Table **Handset**

You can use the following functions to customize your unit. See the corresponding pages for function details.

- After pressing **[MENU]**, you can also program menu items directly by pressing **[0]** to **[9]**, **[\*]** and **[#]** instead of using the soft keys (p. 81–82).

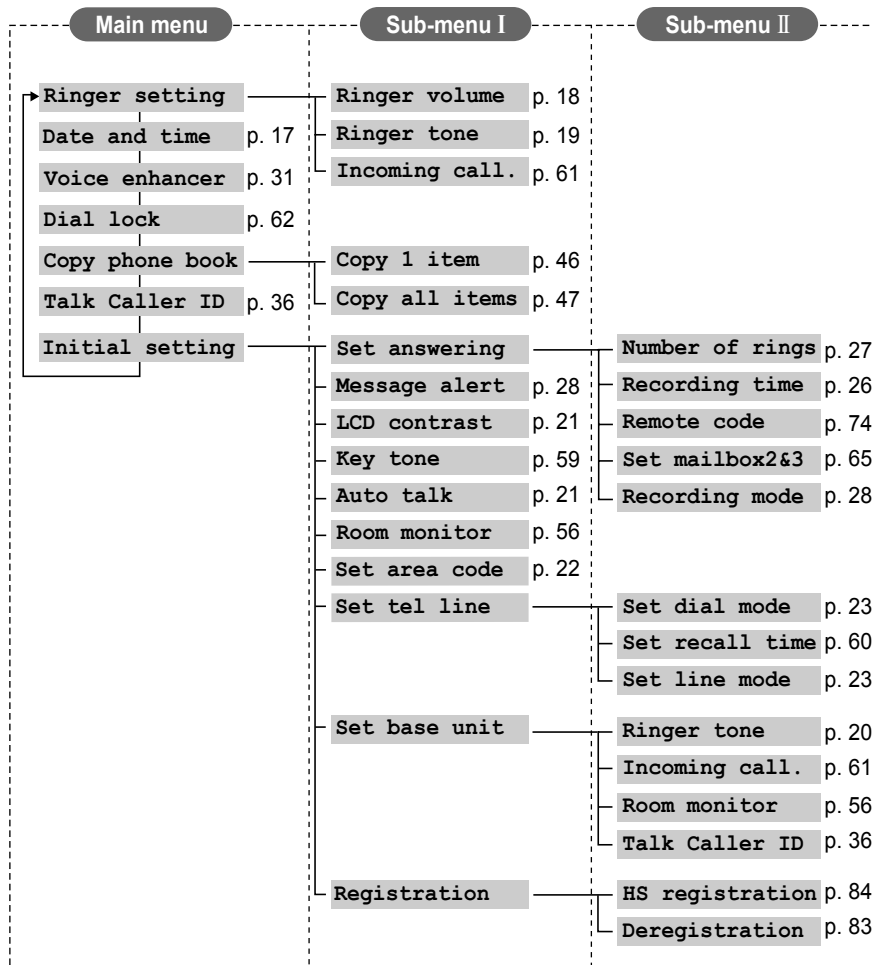

- If you program the date and time, dial lock, dialling mode, recall time, line mode, number of rings, recording time, recording mode, mailbox passwords or the remote code using one of the handsets, you will not need to program the same item using another handset.



## Programmable Settings

### Date and Time **Handset**

You need to set the date and time to announce the day and time when each message was recorded, during a message playback.

**1** Press **[MENU]**.

**2** Scroll to "Date and time" by pressing **[▼]** or **[▲]**, then press the soft key **(SELECT)**.

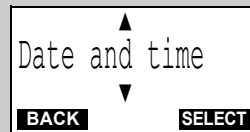

**3** (1) Enter 2 digits each for the day, month and year. (Ex. To set May 15, 2004, enter "15 05 04".)  
 (2) Enter 4 digits for the time (hour and minute). (Ex. To set 9:30, enter "0930".)  
 • If you enter a wrong number, press the soft key **(◀)** or **(▶)**, or press **[▲]** or **[▼]** to move the cursor to the incorrect number. Enter the correct number.

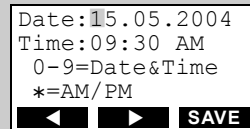
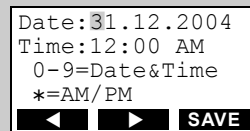

**4** Select "AM" or "PM" by pressing **[\*]**.

**5** Press the soft key **(SAVE)**.

- The date and time are set and "Ⓢ" disappears from the base unit display.
- If the handset beeps 3 times, the date and time were not set correctly. Start again from step 3.

**6** Press **[OFF]**.

- When entering the time, you cannot enter numbers greater than 12. **Do not use military time.** (To set 13:00 hours, enter "0100", and select "PM" in step 4.)

The date and time may be incorrect after a power failure. When "Ⓢ" flashes on the base unit display, set the date and time again.

**To confirm the date and time, repeat steps 1 and 2 above.**

- The current date and time are displayed. When finished, press **[OFF]**.

#### For Caller ID service users (p. 34)

- When a call is received, Caller ID information adjusts the date and time if the time is incorrect.
- Caller ID information will automatically adjust the date and time for daylight saving time.
- If the date and time have not been previously set, Caller ID information will not adjust the date and time.

Preparation

## Programmable Settings

### Ringer Volume

You can set the handset and base unit ringer volumes to high, medium, low, or off. The factory preset is HIGH. If the handset or base unit ringer is turned off, the handset or base unit will ring at the low level for intercom calls, and will not ring for outside calls. Caller names will not be announced even if the Talking Caller ID feature is turned on (p. 36).

#### Handset ringer volume **Handset**

**1** Press **[MENU]**.

**2** Press the soft key (**SELECT**) at "Ringer setting".

Ringer setting

**3** Press the soft key (**SELECT**) at "Ringer volume".

Ringer volume

**4** Select the desired volume by pressing **[▼]** or **[▲]**.

- The volume will change and ring.
- The number of steps indicates the volume level.
- **To turn the ringer off**, press **[▼]** repeatedly until "Off ?" is displayed.

Ex. High

Ringer volume  
Low  High

Ex. Off

Ringer volume  
Off ?

**5** Press the soft key (**SAVE**).

- If the handset ringer is turned off, the handset displays "Ringer off" while not in use.
- You can also adjust the ringer volume while an outside call is ringing. Press **[▼]** or **[▲]** while the handset is ringing.

#### Temporary ringer off

While the handset is ringing for an outside call, you can turn the ringer off temporarily by pressing **[OFF]**. The handset will ring again as normal the next time a call is received.

## Programmable Settings

### Base unit ringer volume **Base Unit**

Make sure the base unit is not being used.

To set the ringer volume to high (preset), medium, or low, press [▼] or [▲].

- To increase volume, press [▲]. To decrease volume, press [▼].
- To stop ringing, press [STOP].

To turn the ringer off, press and hold [▼] until 2 beeps sound.

- "RINGER OFF" is displayed.

To turn the ringer on, press [▼] or [▲].

- The base unit will ring at the low level.
- You can adjust the ringer volume while an outside call is ringing. Press [▼] or [▲] while the base unit is ringing. To turn the ringer off, press and hold [▼] until 2 beeps sound. "RINGER OFF" is displayed.

Preparation

### Ringer Tone

You can set the handset and base unit ringers to use one of 7 ringer patterns for outside calls. "Tone 1" to "Tone 3" are bell ringer patterns. "Melody 1" to "Melody 4" are melody patterns. The factory preset is "Tone 1".

- You cannot change the ringer tone for intercom calls.
- If you select one of the melody ringer patterns, the ringer will continue to sound for several seconds if:
  - the caller hangs up before you answer the call, or
  - another person answers the call using another phone connected on the same line.

### Handset ringer tone **Handset**

1 Press [MENU].

2 Press the soft key (SELECT) at "Ringer setting".

Ringer setting

3 Scroll to "Ringer tone" by pressing [▼] or [▲], then press the soft key (SELECT).

Ringer tone

4 Select the desired ringer tone by pressing [▼] or [▲].

- The handset will ring and the ringer tone will change. If the ringer volume has been turned off, the handset will not ring (p. 18).
- You can also select the ringer tone by pressing [1] to [7].

Ringer tone  
1:Tone 1

5 Press the soft key (SAVE), then press [OFF].

## Programmable Settings

### Base unit ringer tone (use either the handset or the base unit)

#### Base Unit

Make sure the base unit is not being used.

- 1 Press [**◀◀**] or [**▶▶**].
  - The base unit will ring using the current ringer tone. If the ringer volume has been turned off, the base unit will not ring (p. 19).
- 2 Press [**◀◀**] or [**▶▶**] repeatedly to select the desired tone.
  - Each time you press [**◀◀**] or [**▶▶**], another ringer tone will be heard and selected.
  - To stop ringing, press [**STOP**].
  - You can also select the ringer tone by pressing [**1**] to [**7**].
    - [**1**] to [**3**]: Bell ringer patterns
    - [**4**] to [**7**]: Melody patterns

#### Selecting the base unit ringer tone by using the Handset

- 1 Press [**MENU**].
- 2 Scroll to "Initial setting" by pressing [**▼**] or [**▲**], then press the soft key (**SELECT**).
 

Initial setting
-----------------
- 3 Scroll to "Set base unit" by pressing [**▼**] or [**▲**], then press the soft key (**SELECT**).
 

Set base unit
---------------
- 4 Press the soft key (**SELECT**) at "Ringer tone".
 

Ringer tone
-------------
- 5 Select the desired ringer tone by pressing [**▼**] or [**▲**].
  - When selecting the ringer tone, the base unit will ring. If the base unit ringer volume has been turned off, the base unit will not ring (p. 19).
  - You can also select the ringer tone by pressing [**1**] to [**7**].
    - [**1**] to [**3**]: Bell ringer patterns
    - [**4**] to [**7**]: Melody patterns

Ringer tone 1:Tone 1
-------------------------
- 6 Press the soft key (**SAVE**), then press [**OFF**].

## Programmable Settings

### Auto Talk **Handset**

The Auto Talk feature allows you to answer calls by simply lifting the handset off the base unit (or the charger, for accessory handset users, p. 3). You do not need to press [↶] or [↷]. The factory preset is OFF.

1 Press [MENU].

2 Scroll to "Initial setting" by pressing [▼] or [▲], then press the soft key (SELECT).

Initial setting

3 Scroll to "Auto talk" by pressing [▼] or [▲], then press the soft key (SELECT).

Auto talk

4 Select "On" or "Off" by pressing [▼] or [▲].

Auto talk  
:Off

5 Press the soft key (SAVE), then press [OFF].

- In order to view Caller ID information after you lift the handset to answer a call, leave the Auto Talk feature turned off.

### LCD Contrast **Handset**

There are 6 levels of LCD contrast. The factory preset is "level 3".

1 Press [MENU].

2 Scroll to "Initial setting" by pressing [▼] or [▲], then press the soft key (SELECT).

Initial setting

3 Scroll to "LCD contrast" by pressing [▼] or [▲], then press the soft key (SELECT).

LCD contrast

4 Select the desired contrast by pressing [▼] or [▲].

- The contrast will change.
- The number of steps indicates the contrast level.

Ex. Level 3  
LCD contrast  
Low ███ High

5 Press the soft key (SAVE), then press [OFF].

Preparation

## Programmable Settings

### Storing Your Area Code **Handset**

We recommend you program your area code before using the Caller ID feature (p. 34). Incoming calls from the same area will be then recorded in the Caller List without the area code. You do not have to remove the code before calling back or storing.

#### To store your area code

1 Press **[MENU]**.

2 Scroll to "Initial setting" by pressing **[▼]** or **[▲]**, then press the soft key **(SELECT)**.

Initial setting

3 Scroll to "Set area code" by pressing **[▼]** or **[▲]**, then press the soft key **(SELECT)**.

Set area code

4 Enter your area code of up to 8 digits.

- To delete a digit, press the soft key **(CLEAR)**.
- To erase all of the digits, press and hold the soft key **(CLEAR)**.

Ex. Entered 02

Set area code  
02

5 Press the soft key **(SAVE)**, then press **[OFF]**.

#### To erase your area code

Press the soft key **(CLEAR)** in step 4, press the soft key **(SAVE)**, and press **[OFF]**.

## Programmable Settings

### Line Mode **Handset**

The line mode is preset to "B" and generally should not be adjusted. If "IN USE" is not displayed on the handset properly, the line mode selection is incorrect. Set line mode to "A".

Preparation

1 Press **[MENU]**.

2 Scroll to "Initial setting" by pressing **[▼]** or **[▲]**, then press the soft key **(SELECT)**.

Initial setting

3 Scroll to "Set tel line" by pressing **[▼]** or **[▲]**, then press the soft key **(SELECT)**.

Set tel line

4 Scroll to "Set line mode" by pressing **[▼]** or **[▲]**, then press the soft key **(SELECT)**.

Set line mode

5 Select "A" or "B" by pressing **[▼]** or **[▲]**.

Set line mode  
:B

6 Press the soft key **(SAVE)**, then press **[OFF]**.

### Dialling Mode **Handset**

If the unit cannot make an outside call, the dialling mode may be incorrect. Set the dialling mode to "Tone".

1 Press **[MENU]**.

2 Scroll to "Initial setting" by pressing **[▼]** or **[▲]**, then press the soft key **(SELECT)**.

Initial setting

3 Scroll to "Set tel line" by pressing **[▼]** or **[▲]**, then press the soft key **(SELECT)**.

Set tel line

4 Press the soft key **(SELECT)** at "Set dial mode".

Set dial mode

5 Select "Tone" by pressing **[▼]** or **[▲]**.

Set dial mode  
:Tone

6 Press the soft key **(SAVE)**, then press **[OFF]**.

# Preparing the Answering System

## Greeting Message **Base Unit**

You can record a personal greeting message of **up to 2 minutes**. If you do not record your own message, one of two pre-recorded greetings will be played for callers (p. 25).

The total recording time of all messages (greeting, incoming and memo) is **about 16 minutes**. We recommend you record a **brief greeting message** in order to leave more time for recording new messages.

- You can use the enhanced recording mode for clearer sound, if necessary (p. 28).

### To record a greeting message

#### Greeting message samples

- “Hello, this is (your name and/or number). Sorry, I cannot take your call. Please leave a message after the beep. Thank you.”
- **To instruct callers to leave a message in a specific mailbox (Mailbox 1, Mailbox 2, or Mailbox 3) (for mailboxes see page 64):**  
 “Hello, this is (your name and/or number). Sorry, we cannot take your call. If you have a message, for John press [#] and [1], for Jane press [#] and [2], for Jack press [#] and [3], before the beep. Or just stay on the line and leave a message after the beep. Thank you.”

#### 1 Press **[GREETING REC]**.

- “To record greeting, press RECORD again” is heard.

#### 2 Within 10 seconds, press **[GREETING REC]** again to record your greeting.

#### 3 After the long beep, talk clearly, about 20 cm away from the **MIC** (microphone).

- The elapsed recording time is displayed.
- If you record for over 2 minutes, the unit will stop recording.

#### 4 When finished, press **[GREETING REC]** or **[STOP]**.

- To change the greeting, start again from step 1.

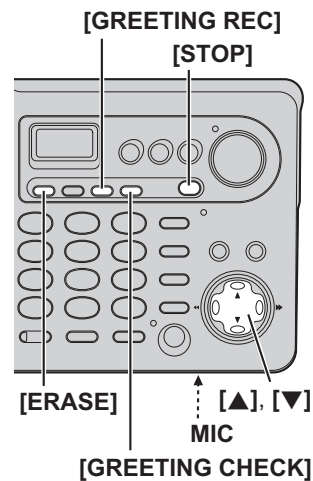

- If “E” is displayed, 6 beeps sound and “Your greeting was not recorded. Record your greeting again.” is announced, start again from step 1.



## Preparing the Answering System

### To review the greeting

Press **[GREETING CHECK]**.

**To adjust the speaker volume**, press **[▼]** or **[▲]** during playback.

- 9 levels (0–8) are available while using the Answering System. The level is displayed on the base unit.

### To erase the greeting

Press **[GREETING CHECK]**, then press **[ERASE]** while the recorded message is being played.

- The unit will answer calls with a pre-recorded greeting (see below).

### Pre-recorded greeting

If you do not record a greeting (p. 24), one of two greetings will be played when a call is received, depending on the caller's recording time (p. 26).

**To review the pre-recorded greeting**, press **[GREETING CHECK]**.

- A pre-recorded greeting will be played as follows:
  - When the recording time is set to "1 minute", "2 minutes" or "3 minutes":  
"Hello, we are not available now. Please leave your name and phone number after the beep. We will return your call."
  - If recording time runs out, the unit will automatically switch to the "Greeting only" mode (see below), and no new messages will be recorded.
  - When the recording time is set to "Greeting only": "Hello, we are not available now. Please call again. Thank you for your call."

#### Flash Memory Message Backup (Message storage)

Messages stored in memory will not be affected by power failures. All messages are saved until you erase them.

Preparation

## Preparing the Answering System

### Caller's Recording Time **Handset**

You can select "1 minute", "2 minutes", "3 minutes" or "Greeting only" for the caller's recording time. The factory preset is "3 minutes".

**1** Press **[MENU]**.

**2** Scroll to "Initial setting" by pressing **[▼]** or **[▲]**, then press the soft key (**SELECT**).

Initial setting

**3** Press the soft key (**SELECT**) at "Set answering".

Set answering

**4** Scroll to "Recording time" by pressing **[▼]** or **[▲]**, then press the soft key (**SELECT**).

Recording time

**5** Select the recording time by pressing **[▼]** or **[▲]**.

- You can also select the recording time by pressing **[1]**, **[2]**, **[3]**, or **[0]** (Greeting only).

Recording time  
:3min

**6** Press the soft key (**SAVE**), then press **[OFF]**.

If you select "Greeting only", the unit will answer a call with the greeting message, and then hang up. The unit will not record any incoming messages. The base unit will display "9" instead of the number of messages.

## Preparing the Answering System

### Number of Rings **Handset**

You can select the number of times the unit rings before the Answering System answers a call, from “2” to “7” or “Toll saver”. The factory preset is “4”.

**1** Press **[MENU]**.

**2** Scroll to “Initial setting” by pressing **[▼]** or **[▲]**, then press the soft key **(SELECT)**.

Initial setting

**3** Press the soft key **(SELECT)** at “Set answering”.

Set answering

**4** Press the soft key **(SELECT)** at “Number of rings”.

Number of rings

**5** Select the number of rings by pressing **[▼]** or **[▲]**.

- You can also select the number of rings by pressing **[0]** (Toll saver\*), or **[2]** to **[7]**.
- **The unit will announce a caller’s name after the 2nd ring (Talking Caller ID, p. 34, 35). To listen to the name announcements, do not select “2”.**

Number of rings  
:4

**6** Press the soft key **(SAVE)**, then press **[OFF]**.

#### \*Toll saver

When you call the unit from a remote location, the number of rings will tell you if there are any new messages. If the unit answers on the 2nd ring, there is at least one new message. If the unit answers on the 4th ring, there are no new messages. To save the toll charges for the call, hang up immediately when you hear the 3rd ring. The 3rd ring indicates that there are no new messages.

- The unit will announce a caller’s name after the 2nd ring (Talking Caller ID, p. 34, 35). If “Toll saver” is selected, and there is a new message, the unit will not announce the caller’s name.

Preparation

## Preparing the Answering System

### Recording Mode **Handset**

Two recording modes are available. The factory preset is “Standard recording (16 min)”, which provides more recording time (16 min) and standard sound quality. “Enhanced recording (8 min)” provides less recording time (8 min) but clearer sound quality.

- 1 Press **[MENU]**.
- 2 Scroll to “Initial setting” by pressing **[▼]** or **[▲]**, then press the soft key **(SELECT)**.
- 3 Press the soft key **(SELECT)** at “Set answering”.
- 4 Scroll to “Recording mode” by pressing **[▼]** or **[▲]**, then press the soft key **(SELECT)**.
 

Recording mode
----------------
- 5 Select the recording mode by pressing **[▼]** or **[▲]**.
  - You can also select the recording mode by pressing **[1]** (Standard) or **[2]** (Enhanced).

Recording mode :Standard recording 16min
--
- 6 Press the soft key **(SAVE)**, then press **[OFF]**.

### Message Alert **Handset**

You can select whether or not the Ringer/Message Alert indicator on the handset will flash slowly when new messages have been recorded (p. 67). The factory preset is OFF.

- 1 Press **[MENU]**.
- 2 Scroll to “Initial setting” by pressing **[▼]** or **[▲]**, then press the soft key **(SELECT)**.
- 3 Scroll to “Message alert” by pressing **[▼]** or **[▲]**, then press the soft key **(SELECT)**.
 

Message alert
---------------
- 4 Select “On” or “Off” by pressing **[▼]** or **[▲]**.
 

Message alert :Off
-----------------------
- 5 Press the soft key **(SAVE)**, then press **[OFF]**.

- The Ringer/Message Alert indicator will not flash for new messages while the handset is in use.
- The Ringer/Message Alert indicator acts as a ringer indicator and as a message alert indicator. This indicator will flash rapidly when a call is received whether this feature is on or off.
- Battery operating time may be shortened when using this feature (p. 14).

## Making Calls

### System capabilities (Operating more than one handset, p. 3)

Up to 3 extensions (3 handsets or 2 handsets and the base unit) can operate at a time. The maximum operating number may decrease depending on the state of use.

### Using the Handset **Handset**

- 1 Press [**📞**].
  - "Talk" is displayed.
- 2 Dial a phone number.
  - The dialled number is displayed.
  - After a few seconds, the display will show the length of the call.
- 3 To hang up, press [**OFF**] or place the handset on the base unit.

### To have a hands-free phone conversation

- 1 Press [**📞**].
  - "SP-phone" is displayed.
- 2 Dial a phone number.
  - The dialled number is displayed.
  - After a few seconds, the display will show the length of the call.
- 3 When the other party answers, talk into the microphone.
- 4 To hang up, press [**OFF**] or place the handset on the base unit.

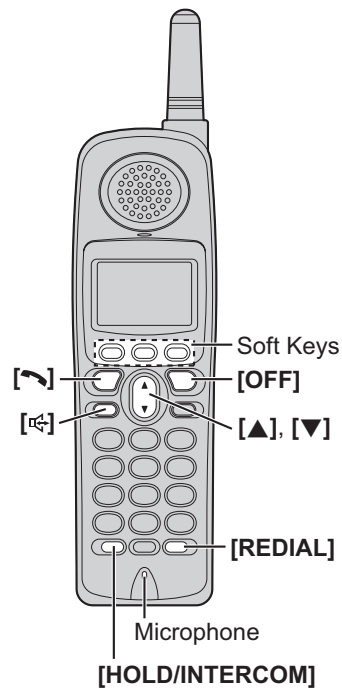

Telephone System

### Hands-free Digital Duplex Speakerphone

For best performance, please note the following:

- Talk alternately with the other party in a quiet room.
- If you or the other party has difficulty hearing, press [**▼**] to decrease the speaker volume.
- While talking using [**📞**], you can switch to a hands-free phone conversation by pressing [**📞**]. To switch back to the receiver, press [**📞**].

## Making Calls

### To dial after confirming the entered number

1. Enter a phone number.

3334444

- If you misdial, press the soft key **(CLEAR)**. Enter the correct phone number.
- If a pause is required when dialling, press the soft key **(PAUSE)** where needed (p. 58).
- To cancel, press **[OFF]**.

2. Press **[↶]** or **[↷]**.
3. To hang up, press **[OFF]** or place the handset on the base unit.

### To adjust the receiver/speaker volume during a conversation

There are 3 volume levels for the receiver and 6 volume levels for the speaker.

To increase volume, press **[▲]**.  
To decrease volume, press **[▼]**.

Ex. Receiver volume: High  
Speaker volume: Level 6



- The display shows the current volume setting.
- If you try to increase/decrease volume when it is at the maximum/minimum level, the handset will beep 3 times.

### To redial the last number dialled

Press **[↶]** or **[↷]**, then press **[REDIAL]**.

### To redial using the redial list (Memory Redial)

The last 5 phone numbers dialled are stored in the redial list.

1. Press **[REDIAL]**.
  - The last number dialled is displayed.
2. Scroll to the desired number by pressing **[▼]** or **[▲]**.
  - You can also scroll down through the list by pressing **[REDIAL]**.
  - To exit the list, press **[OFF]**.
3. Press **[↶]** or **[↷]**.
  - To erase an item, scroll to the item then press the soft key **(ERASE)**.
  - If "No items stored" is displayed, the list is empty.

### To put a call on hold

1. Press **[HOLD/INTERCOM]** during a conversation.
  - "Press extension# to transfer" is displayed.
  - To transfer the call to the base unit or another handset, see page 52; to transfer to a mailbox, see page 72.
2. Press **[HOLD/INTERCOM]** again.
  - "Hold" is displayed.

### To return to the call, press **[↶]** or **[↷]**.

- The base unit user can also take the call by pressing **[SP-PHONE]**.
- Another handset user can also take the call by pressing **[↶]** or **[↷]**.
- If another phone is connected on the same line (p. 12), you can also take the call by lifting its handset.
- If a call is kept on hold for 6 minutes, an alarm tone will start to sound and the Ringer/Message Alert indicator will start to flash rapidly. After 4 additional minutes on hold, the call will be disconnected.

## Making Calls

### Voice Enhancer Technology

Panasonic's Voice Enhancer Technology can simulate a band signal above the normal bandwidth limitations, achieving a sound which is close to the actual voice. You can turn this feature on or off, depending on the circumstance. The factory preset is OFF.

- Depending on the condition and quality of your telephone line, this feature may emphasize existing line noise. If it becomes difficult to hear, turn this feature off.

**To turn this feature on**, press the soft key **(VE)** during a conversation.

- **"VE"** is displayed.
- **To turn this feature off**, press the soft key **(VE)** again. **"VE"** disappears from the display.

- After hanging up a call, the on/off setting will be retained.

When the handset is not in use, you can also turn this feature on or off by programming as follows:

1. Press **[MENU]**.
2. Scroll to "Voice enhancer" by pressing **[▼]** or **[▲]**, then press the soft key **(SELECT)**.
3. Select "On" or "Off" by pressing **[▼]** or **[▲]**.
4. Press the soft key **(SAVE)**, then press **[OFF]**.

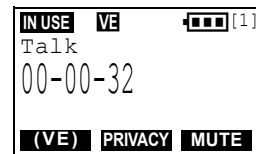

### Clarity Booster

This feature can improve sound clarity when the handset is used in an area where there may be interference. During an outside call, this feature will be turned on automatically when necessary. This feature will turn off when you hang up, put a call on hold, or make a conference call. It will not turn off automatically during a call. You can also turn this feature on or off manually.

1. Press **[MENU]** during an outside call.
2. Press **[2]** to select "2=Booster on" or "2=Booster off".

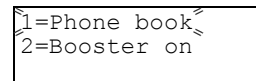

- You can also select "2=Booster on" or "2=Booster off" by pressing **[▼]** then pressing the soft key **(SELECT)**.
- While this feature is turned on, "Booster on" will flash during a conversation.
- If this feature is turned off manually during a call, it will not be turned on automatically during the same call.
- When this feature is turned on automatically or manually, battery operating time may be shortened (p. 14).
- The maximum number of extensions which can be used at a time may decrease when using this feature.

### Backlit LCD display/Lighted handset keypad

The handset display and dialling buttons will light for a few seconds after pressing a button or lifting the handset off the base unit (or the charger, for accessory handset users, p. 3). They will also light when an intercom/outside call is being received.

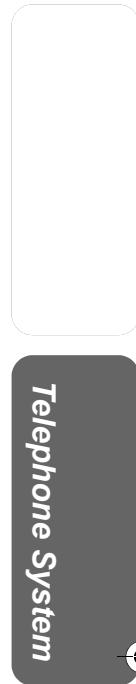

## Making Calls

### Using the Base Unit **Base Unit**

- 1** Press **[SP-PHONE]**.
  - The indicator lights.
- 2** Dial a phone number.
  - If you misdial, press **[SP-PHONE]** and start again from step 1.
- 3** When the other party answers, talk into the **MIC** (microphone).
- 4** To hang up, press **[SP-PHONE]**.
  - The indicator light goes out.

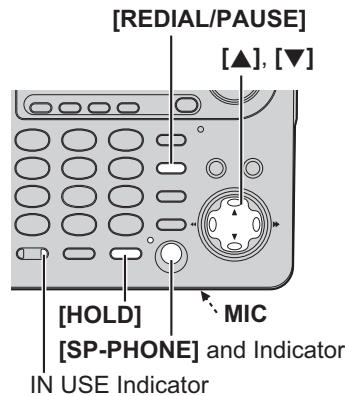

- To switch to the handset while using the base unit speakerphone:
  - If the handset is off the base unit, press [📞] or [📞] on the handset, then press **[SP-PHONE]** on the base unit.
  - If the handset is on the base unit, just lift up.

#### Hands-free Digital Duplex Speakerphone

For best performance, please note the following:

- Talk alternately with the other party in a quiet room.
- If you or the other party has difficulty hearing, press [▼] to decrease the speaker volume.

#### To adjust the speaker volume during a conversation

To increase volume, press [▲]. To decrease volume, press [▼].

- There are 8 volume levels. If you try to increase/decrease volume when it is at the maximum/minimum level, the base unit beeps 3 times. The level is displayed on the base unit.

#### To redial the last number dialed

Press **[SP-PHONE]**, then press **[REDIAL/PAUSE]**.

#### To put a call on hold

Press **[HOLD]** during a conversation.

- The SP-PHONE indicator and IN USE indicator flash.

#### To return to the call, press **[SP-PHONE]**.

- The handset users can also take the call by pressing [📞] or [📞].
- If another phone is connected on the same line (p. 12), you can also take the call by lifting its handset.
- If a call is kept on hold for 6 minutes, an alarm tone will start to sound. After 4 additional minutes on hold the call will be disconnected.



## Answering Calls

When a call is received, the unit rings, "Incoming call" is displayed, and the Ringer/Message Alert indicator on the handset and the IN USE indicator on the base unit flash rapidly.

### Handset

- 1 Press [] or [].
  - You can also answer a call by pressing any button except [, [, or [OFF].
- 2 To hang up, press [OFF] or place the handset on the base unit.

### Auto Talk

If the Auto Talk feature is turned on (p. 21), you can answer a call by simply lifting the handset off the base unit (or the charger, for accessory handset users, p. 3).

### Temporary ringer off

While the handset is ringing for an outside call, you can turn the ringer off temporarily by pressing [OFF]. The handset will ring again as normal the next time a call is received.



### Base Unit

- 1 Press [SP-PHONE].
- 2 Talk into the MIC.
- 3 To hang up, press [SP-PHONE].

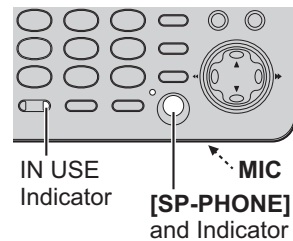

- To transfer the call to another extension, see page 52.
- To transfer the call to a mailbox to allow the caller to leave a message, see page 72.
- If the ringer volume is turned off, the unit will not ring (p. 18, 19).

## Caller ID Service

This unit is compatible with Caller ID services offered by your telephone company. If you subscribe to Caller ID, callers' information will be displayed and recorded in the Caller List.

### How Caller ID information is displayed

When a call comes in, the unit will ring and the Caller ID information will be received. The handset display will show the caller's phone number after the ring.\*

Example

0555222333

- After you answer the call, the display will show the length of the call.

### \*Private name display

If you receive a call from one of the phone numbers stored in the phone book, the handset will show the caller's name stored in the phone book.

Example

TINA ROBINSON  
0555222333

The handset and base unit will announce the displayed name (Ex. "Call from TINA ROBINSON") following every ring (**Talking Caller ID feature**, p. 35).

- To use this function, names and phone numbers must be stored in the phone book (p. 41).
- If the handsets each have the same phone number stored with a different name, each handset will display the name stored in its own phone book.
- If the unit does not receive Caller ID information, one of the following will be displayed:

Display	Meaning
Out of area	The caller dialed from an area which does not provide Caller ID service.
Private caller	The caller requested not to send his/her information.

- Depending on radio communications with the base unit, the handset may not display Caller ID information immediately after the ring.
  - If your unit is connected to a PBX which does not support Caller ID, you cannot access Caller ID services.
  - If the name display service is available in your area, the display will show callers' names. For further information, please contact your telephone company.
  - If you subscribe to Caller ID services, when a second call is received while talking, a call waiting tone will be heard and the second caller's information will be displayed (p. 59).
- Contact Telstra or your service provider for details and availability in your area.

## Caller ID Service

### Talking Caller ID **Handset** **Base Unit**

To use this feature, you need to subscribe to Caller ID. For further information, please contact your telephone company.

The factory preset of the Talking Caller ID feature is ON (p. 36).

When a call is received, the unit will ring and receive Caller ID information.

Example

TINA ROBINSON
0555222333

If you receive a call from one of the phone numbers stored in the phone book or if the name display service is available in your area, the caller's name will be displayed and announced.

### Announcing caller information (Talking Caller ID)

If the caller's phone number is stored in the phone book of the extension number 1 handset, all handsets and the base unit will announce the name stored in that phone book (Ex. "Call from TINA ROBINSON") following every ring.

- If the caller's phone number is not stored in the phone book of the extension number 1 handset, "Number available" is announced, indicating you should look at the display to see who is calling.
- Depending on your telephone company, the unit may announce "Number available" before announcing the caller's name stored in the phone book of the extension number 1 handset.
- The name announced by the Talking Caller ID feature will be different from the names displayed on the other extension handsets (2 to 4) if the name is stored differently in each phone book.
- If the unit does not receive Caller ID information, the unit will announce "Call from out of area" or "Call from private caller".
- If the ringer volume of the handsets and base unit is off, caller names will not be announced. The announcement is heard at the handset or base unit ringer volume (p. 18, 19).
- If this feature is turned off, caller names will not be announced (p. 36).
- If an outside call is received while on an intercom call between the handset and base unit, the other handset will ring, but the caller's name will not be announced.
- Name pronunciation may vary.
- The unit will announce each letter of abbreviations, such as "Co." and "Inc.".
- Caller ID supports names of up to 15 letters. If the caller's name has more than 15 letters, the name will not be displayed or announced correctly.
- Your unit may mute one or more rings in order to announce the name of the caller. Talking Caller ID takes precedence over ringing.

Telephone System

## Caller ID Service

### To turn on or off Talking Caller ID feature

You can turn on or off Talking Caller ID feature for the handset and base unit separately. If this feature is turned off, the unit will not announce caller names. The factory preset is ON.

#### Handset Talking Caller ID feature **Handset**

1 Press **[MENU]**.

2 Scroll to "Talk Caller ID" by pressing **[▼]** or **[▲]**, then press the soft key **(SELECT)**.

Talk Caller ID

3 Select "Off" or "On" by pressing **[▼]** or **[▲]**.

Talk Caller ID  
:On

4 Press the soft key **(SAVE)**, then press **[OFF]**.

#### Base unit Talking Caller ID feature **Handset**

This feature must be turned on or off for the base unit by using the handset.

1 Press **[MENU]**.

2 Scroll to "Initial setting" by pressing **[▼]** or **[▲]**, then press the soft key **(SELECT)**.

Initial setting

3 Scroll to "Set base unit" by pressing **[▼]** or **[▲]**, then press the soft key **(SELECT)**.

Set base unit

4 Scroll to "Talk Caller ID" by pressing **[▼]** or **[▲]**, then press the soft key **(SELECT)**.

Talk Caller ID

5 Select "Off" or "On" by pressing **[▼]** or **[▲]**.

Talk Caller ID  
:On

6 Press the soft key **(SAVE)**, then press **[OFF]**.

## Using the Caller List

The unit can record information up to 50 different callers and store this information in the Caller List. Caller information is sorted by the most recent call to the oldest. When the 51<sup>st</sup> call is received, the information from the 1<sup>st</sup> call is deleted.

The unit will also tell you how many calls you missed while you were out or unavailable to answer the phone.



② Stands for Caller ID

- ① The handset display will show the number of calls you missed.
- ② Press the soft key (**CID**), [**▼**], or [**▲**] to review other calls logged in the Caller List.
  - If there are no items in the Caller List, "**CID**" will not be displayed.
  - After viewing the missed call entries, "missed calls" will disappear from the display.

### Viewing the Caller List **Handset**

- 1 Press the soft key (**CID**), [**▼**], or [**▲**] to enter the Caller List.

Ex. 10 calls missed.

```

Caller list
10 missed calls
▼▲=Scroll list
    
```

- 2 To search from the most recent call, press [**▼**]. To search from the oldest call, press [**▲**].
  - The caller's number and the time and date of the call are displayed.

Example

```

0555333444
3:10A 10JUN.
    
```

- 3 Press [**OFF**] to exit the list.

- Each handset has its own Caller List. If you viewed the Caller List or answered a call on one handset, the same information in the other handsets will be displayed as "missed".
- If you do not press any buttons for 60 seconds, the unit will exit the Caller List.

## Using the Caller List

### What “√” means

“√” indicates you have already viewed this calling information or answered the call. If the same caller calls again, the call entry with the “√” will be replaced with the new call entry.

0555333444 3:10P 10JUN. √
------------------------------

### If a caller calls more than once

The number of times the same caller called is displayed (“x2” to “x9”). The date and time of the most recent call will be recorded. After viewing a caller’s information, “x2” to “x9” will be replaced with “√”.

Ex. Called 3 times.

0555456789 11:20A 12JAN. x3
--------------------------------

## Calling Back from the Caller List **Handset**

- 1 Press the soft key (**CID**), [▼], or [▲] to enter the Caller List.
- 2 Scroll to the desired caller by pressing [▼] or [▲].
- 3 Press [↶] or [↷].
  - The phone number is dialed.

- In some cases, you may have to edit the number before dialling (p. 39).
- If a phone number is not displayed in the caller information, you cannot call that caller back from the Caller List.

## Using the Caller List

### Editing the Caller's Phone Number **Handset**

You can edit a phone number in the Caller List to call it back or store it in the phone book.

**1** Press the soft key (**CID**), [**▼**], or [**▲**] to enter the Caller List.

**2** Scroll to the desired caller by pressing [**▼**] or [**▲**].

0555321555  
11:20A 12JAN.

**3** Press the soft key (**EDIT**).

**4** Add or erase digits to the beginning of the number as desired.

- To add a digit, enter a number.
- To erase a digit, press the soft key (**CLEAR**) or [**#**].

0555321555

**5** To make a call to the edited number, press [**↶**] or [**☎**].  
To store the edited number in the phone book, press the soft key (**SAVE**).  
• If the phone number has no name information when it is stored, continue from (1) under step 3 of "Storing Caller Information in the Phone Book" on page 40.

- The number edited in step 4 will not be maintained in the Caller List.
- You cannot edit a phone number, if the dial lock is turned on (p. 62).

### To quickly add or erase a digit at the beginning of a phone number in the Caller List

1. Follow steps 1 and 2 above.
2. Add or erase digits to the beginning of the number as desired.
  - To add a digit, enter a number.
  - To erase a digit, press [**#**].
3. To make a call to the edited number, press [**↶**] or [**☎**].  
To store the edited number in the phone book, press the soft key (**SAVE**).

## Using the Caller List

### Storing Caller Information in the Phone Book **Handset**

Caller phone numbers that are in the Caller List can be stored in the phone book.

- 1** Press the soft key (**CID**), [**▼**], or [**▲**] to enter the Caller List.
- 2** Scroll to the desired caller by pressing [**▼**] or [**▲**].
  - If the number requires editing, see page 39.
- 3** Press the soft key (**SAVE**).
  - If there is no name information for the caller, "Enter name" will be displayed.
    - You can enter a name by performing the following steps:
      - (1) enter the name (p. 42),
      - (2) press [**▼**], and
      - (3) press the soft key (**SAVE**).
    - If a name is not required, press [**▼**], then press the soft key (**SAVE**).
  - To continue storing other items, repeat from step 2.
  - To exit programming mode, press [**OFF**].

- You cannot store Caller List items in the phone book if a phone number is not displayed or the dial lock is turned on (p. 62).

### Erasing Caller Information **Handset**

#### To erase a specific caller

- 1** Press the soft key (**CID**), [**▼**], or [**▲**] to enter the Caller List.
- 2** Scroll to the desired caller by pressing [**▼**] or [**▲**].
- 3** Press the soft key (**ERASE**).
  - "Erased" is displayed.
  - To erase other items, repeat from step 2.
  - To exit the Caller List, press [**OFF**].

#### To erase all entries

- 1** Press the soft key (**CID**), [**▼**], or [**▲**] to enter the Caller List.
  - Before erasing all entries, make sure that "0 missed call" is displayed.
- 2** Press the soft key (**ERASE**).
  - "All erase?" is displayed.
  - To cancel erasing, press the soft key (**NO**).
- 3** Press the soft key (**YES**).
  - "All erased" is displayed and all entries in your Caller List are erased.



# Phone Book

The handset can store up to 50 names and phone numbers in its phone book. You can make a call by selecting a name or number from the phone book, and copy phone book items from one handset to another (p. 46, 47).

## Storing Names and Numbers **Handset**

**1** Press the soft key (☰).

- The display will show the number of stored items.

Phone book  
10 items  
0-9=Name search  
▼▲=Scroll list

**2** Press the soft key (**ADD**).

**3** Enter a name of up to 16 characters with the dialing buttons ([0] to [9]) (p. 42), then press [▼].

- To move the cursor, press the soft key (◀) or (▶).
- If a name is not required, press [▼] then go to step 4.

Enter name  
Tom  
▼=Next

**4** Enter a phone number of up to 32 digits.

- To delete a digit, press the soft key (**CLEAR**).
- To erase all of the digits, press and hold the soft key (**CLEAR**).

Enter phone no.  
0555654321  
▼=Next

**5** Press [▼].

- If you want to change the name, press the soft key (**EDIT**). The display returns to step 3. Change the name.
- If you want to change the number, press [▲]. The display returns to step 4. Change the number.

Tom  
0555654321

**6** Press the soft key (**SAVE**).

- To continue storing other items, repeat from step 2.

**7** Press [OFF].

When the dial lock is turned on (p. 62), only numbers stored in the phone book as emergency numbers can be dialled.

### To store an emergency number:

When storing a name in step 3, press [1] to enter # at the beginning of the name (p. 42).

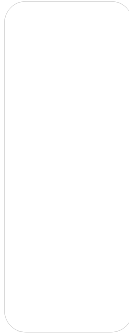

## Phone Book

- If a pause is required when dialling, press the soft key (**PAUSE**) in step 4 on page 41. A pause is stored in a phone number as one digit (p. 58).
- To store numbers for calling card access (see “Chain Dial” on page 44), we recommend you add pauses after each item. Storing pauses with numbers will prevent misdialling (p. 58). The delay time necessary will depend on your telephone company.
- You cannot store a name and phone number in the phone book if the dial lock is turned on (p. 62).

### Selecting characters to enter names

Enter names using the dialling buttons. Press each button until the desired character is displayed.

- Pressing each button selects a character in the order shown below.

Keys	Characters	Keys	Characters
[1]	# & ' ( ) * , - . / 1	[6]	m n o M N O 6
[2]	a b c A B C 2	[7]	p q r s P Q R S 7
[3]	d e f D E F 3	[8]	t u v T U V 8
[4]	g h i G H I 4	[9]	w x y z W X Y Z 9
[5]	j k l J K L 5	[0]	0 Space
	Moves the cursor to the left.		
	Moves the cursor to the right. (To enter another character using the same number key, move the cursor to the next space.)		

**For example, to enter “Tom”:**

1. Press **[8]** four times.
2. Press **[6]** three times, then press the soft key () to move the cursor.
3. Press **[6]** once.

T
To
Tom

### If you make a mistake while entering a name or number

1. Press the soft key () or () to move the cursor to the incorrect character.
2. Press the soft key (**CLEAR**) to delete the character.
  - Each time you press the soft key (**CLEAR**), a character is erased.
  - To erase all characters, press and hold the soft key (**CLEAR**).
3. Enter the correct character.

## Phone Book

### Dialling from the Phone Book **Handset**

**1** Press the soft key (☰).

- The display shows the number of stored items.
- You can press the soft key (**SEARCH**) to view the first item.

Phone book  
10 items  
0-9=Name search  
▼▲=Scroll list

**2** Scroll to the desired item. To scroll down, press [▼]. To scroll up, press [▲].

Phone book items are sorted in the following order:

1	Alphabet letters (Alphabetical)
2	Space & ' ( ) , - . /
3	Numbers 0 to 9
4	# *
5	Telephone numbers (If no name is stored)

Frank  
0555456789

**3** Press [↶], [↷], or the soft key (**CALL**).

- The phone number is dialled.

- If "No items stored" is displayed in step 1, the phone book is empty.
- To exit the phone book, press **[OFF]**.

Telephone System

### To search for a name by initial

1. Press the soft key (☰).

2. Press the dialling button for the first letter of the desired name until any name with the same initial is displayed (see the Index table below).

Ex. To find "Frank", press **[3]** repeatedly until the first item under "F" is displayed.

- If there are no items beginning with the character you selected, the first item in the next alphabetical index will be displayed.

3. Press [▼] repeatedly until the desired name is displayed.

### Index table

Keys	Index	Keys	Index
<b>[1]</b>	Symbols, 1	<b>[6]</b>	M, N, O, 6
<b>[2]</b>	A, B, C, 2	<b>[7]</b>	P, Q, R, S, 7
<b>[3]</b>	D, E, F, 3	<b>[8]</b>	T, U, V, 8
<b>[4]</b>	G, H, I, 4	<b>[9]</b>	W, X, Y, Z, 9
<b>[5]</b>	J, K, L, 5	<b>[0]</b>	0, Space

## Phone Book

### Chain Dial **Handset**

You can dial a combination of phone book or manual key pad entries while making a call. This feature can be used, for example, to first automatically dial a calling card access number that you have stored in the phone book, then manually or automatically dial your PIN and then automatically dial the destination number from the phone book.

Ex. Using a long distance calling card

- To prevent misdialing, we recommend you add pauses where needed when storing numbers. For example, add pauses after a calling card access number and your PIN when storing in the phone book (p. 41).
1. Search and dial from the phone book: 18000123456 (Calling card access number)
    - The voice guidance may be announced.
  2. Search and dial from the phone book: 1234 (Calling card PIN)
  3. Search and dial from the phone book: 15550123456 (Destination Number)

**1** While you are on a call;  
Press **[MENU]**.

1=Phone book  
2=Booster on

**2** Press the soft key (**SELECT**) at "1=Phone book", or press **[1]**.

Phone book  
30 items  
0-9=Name search  
▼▲=Scroll list

**3** Search for the desired item by pressing **[▼]** or **[▲]**.  
• To search for an item by initial, see page 43.

Alan  
15550123456

**4** Press the soft key (**CALL**).

- The phone number is dialled.
- If required, repeat steps 1 to 4 for any remaining numbers.

## Phone Book

### Editing an Item in the Phone Book **Handset**

**1** Press the soft key (☰).

**2** Scroll to the desired item by pressing [▼] or [▲].

- To search for the item by initial, see page 43.

Jane  
5456789

**3** Press the soft key (**EDIT**).

Enter name  
Jane  
▼=Next

**4** Edit the name (p. 42), then press [▼].

- If you do not need to change the name, press [▼] then go to step 5.
- To move the cursor, press the soft key (◀) or (▶).

Enter name  
Jane Walker  
▼=Next

**5** Edit the phone number, then press [▼].

- If you do not need to change the number, press [▼] then go to step 6.
- To delete a digit, press the soft key (**CLEAR**).  
To delete all of the digits, press and hold the soft key (**CLEAR**).

Enter phone no.  
0555456789  
▼=Next

**6** Press the soft key (**SAVE**).

- To continue editing other items, repeat from step 2.

**7** Press [OFF].

- You cannot edit an item, if the dial lock is turned on (p. 62).

### Erasing an Item in the Phone Book **Handset**

**1** Press the soft key (☰).

**2** Scroll to the desired item by pressing [▼] or [▲].

- To search for the item by initial, see page 43.

**3** Press the soft key (**ERASE**).

- To cancel erasing, press the soft key (**NO**).

Erase?

**4** Press the soft key (**YES**).

- To erase other items, repeat from step 2.

Erased

**5** Press [OFF].

- You cannot erase an item, if the dial lock is turned on (p. 62).

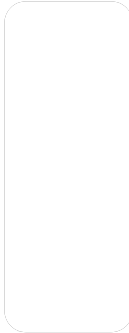

## Phone Book

### Copying Items in the Phone Book **Handset** (When the System Has Two or More Handsets)

You can copy one or all phone book items between two handsets. The destination handset will save the items in its phone book.

- If an outside call is received during the phone book copy, copying will stop. You will need to re-send the item(s) later.
- After the copy has started, do not place your handset on the base unit (or the charger, for accessory handset users, p. 3) until copying finishes, otherwise copying will stop.

#### To copy one phone book item to another handset

Make sure the destination handset is not in use.

**1** Press **[MENU]**.

**2** Scroll to "Copy phone book" by pressing **[▼]** or **[▲]**, then press the soft key **(SELECT)**.

Copy phone book

**3** Press the soft key **(SELECT)** at "Copy 1 item".

Copy 1 item

**4** Select the destination extension number (1 to 4) by pressing **[▼]** or **[▲]**.

- You can also select the extension number by pressing **[1]** to **[4]**.

Enter extension#  
:2  
▼▲

**5** Press the soft key **(NEXT)**.

Select item

**6** Scroll to the desired phone book item by pressing **[▼]** or **[▲]**.

- To search for the item by initial, see page 43.

**7** Press the soft key **(SEND)**.

- To continue copying other items, repeat from step 6.

Complete

**8** Press **[OFF]**.

## Phone Book

### To copy all of the items in your phone book to another handset

Make sure the destination handset is not in use.

**1** Press **[MENU]**.

**2** Scroll to "Copy phone book" by pressing **[▼]** or **[▲]**, then press the soft key **(SELECT)**.

Copy phone book

**3** Scroll to "Copy all items" by pressing **[▼]** or **[▲]**, then press the soft key **(SELECT)**.

Copy all items

**4** Select the destination extension number (1 to 4) by pressing **[▼]** or **[▲]**.

- You can also select the extension number by pressing **[1]** to **[4]**.

Enter extension#  
:2  
▼▲

**5** Press the soft key **(SEND)**.

- When all items have been copied, "Complete" is displayed.
- The destination handset displays "Phone book Receiving" then "Phone book Received".
- To continue copying items to another extension, repeat from step 3.

Ex. Copying 1st item out of 10 items

Tom Jones  
0555666777  
01/10

**6** Press **[OFF]**.

- You can exit phone book copying mode by pressing **[OFF]**.

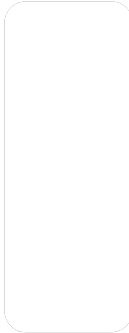

## Speed Dialler

### Storing Phone Numbers **Base Unit**

You can store up to 10 phone numbers in the base unit. The dialling buttons ([0] to [9]) function as memory stations.

**Make sure the base unit is not being used.**

- 1** Press **[PROGRAM]**.
  - The IN USE indicator flashes and “P” is displayed.
- 2** Enter a phone number of up to 32 digits.
  - The last digit of the entered number is displayed.
  - If you misdial, press **[PROGRAM]**, and start again from step 1.
- 3** Press **[AUTO]**.
- 4** Press a memory station number ([0] to [9]).
  - A long beep sounds and the phone number is saved.
  - To store other numbers, repeat from step 1.

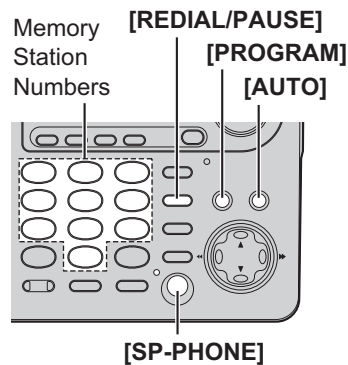

- If a pause is required when dialling, press **[REDIAL/PAUSE]** where needed. “P” is displayed when **[REDIAL/PAUSE]** is pressed. A pause counts as one digit (p. 58).
- When **[\*]** is pressed, “\*” is displayed. When **[#]** is pressed, “#” is displayed.
- If a phone number is stored in a memory location which already contains a phone number, the old number will be erased.
- We recommend you make a note of which phone numbers are stored in which memory locations.
- You cannot store or erase phone numbers in the base unit, if the dial lock is turned on (p. 62).

### To erase a stored number

1. Press **[PROGRAM]**, then press **[AUTO]**.
2. Press the memory station number ([0] to [9]) for the phone number to be erased.
  - A long beep sounds and the phone number is erased.

### Dialling a Stored Phone Number **Base Unit**

- 1** Press **[SP-PHONE]**.
- 2** Press **[AUTO]**.
- 3** Press a memory station number ([0] to [9]).
  - The stored number is dialled.

- Speed dial numbers stored in the base unit can only be dialled from the base unit.
- You cannot dial stored phone numbers, if the dial lock is turned on (p. 62).



# Intercom

Intercom calls can be made between a handset and the base unit, and between two handsets (when the system has two or more handsets, p. 3). You can page all handsets at once from the base unit, and announce the page to all handsets (**Voice Paging**, p. 51).

Page the desired unit(s) by entering the extension number, shown in the top right of each handset's display. The base unit's extension number is 0.

## Making Intercom Calls

### From **Handset**

<p><b>1</b> Press [<b>HOLD/INTERCOM</b>].</p>	<p>Press extension# to call 1-4=Handset 0=Base</p>
<p><b>2</b> To page the base unit, press [<b>0</b>]. To page another handset, press its extension number (<b>[1]</b> to <b>[4]</b>).</p> <ul style="list-style-type: none"> <li>• The paged unit will ring for 1 minute.</li> <li>• To stop paging, press [<b>OFF</b>].</li> </ul>	<p>Ex. Calling Base unit Calling Base</p> <p>Ex. Calling Handset 2 Calling HS[2]</p>
<p><b>3</b> When the paged party answers, start talking.</p> <ul style="list-style-type: none"> <li>• You can switch to the speaker by pressing [<b>☎</b>]. To switch back to the receiver, press [<b>📞</b>].</li> </ul>	<p>Ex. Intercom between Handset 1 &amp; Base unit</p> <p>Intercom 00-00-05 ■ 01</p>
<p><b>4</b> To disconnect the intercom, press [<b>OFF</b>].</p>	

### From **Base Unit**

Using this feature, you can also locate a misplaced handset.

<p><b>1</b> Press [<b>LOCATOR/INTERCOM/TRANSFER</b>].</p> <ul style="list-style-type: none"> <li>• The LOCATOR/INTERCOM/TRANSFER and SP-PHONE indicators light.</li> </ul>
<p><b>2</b> To page all handsets, press [<b>0</b>]. To page a specified handset, press its extension number <b>[1]</b> (<b>/</b>) to <b>[4]</b> (<b>/</b>).</p> <ul style="list-style-type: none"> <li>• The handset(s) will ring for 1 minute.</li> <li>• To stop paging, press [<b>SP-PHONE</b>] or [<b>LOCATOR/INTERCOM/TRANSFER</b>].</li> </ul>
<p><b>3</b> When the paged party answers, talk into the <b>MIC</b>.</p>
<p><b>4</b> To disconnect the intercom, press [<b>SP-PHONE</b>] or [<b>LOCATOR/INTERCOM/TRANSFER</b>].</p> <ul style="list-style-type: none"> <li>• The indicator lights go out.</li> </ul>

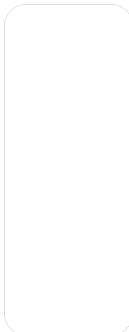

## Intercom

### During an intercom call:

- If you have difficulty hearing while using the speakerphone on the handset or base unit, decrease the speaker volume by pressing [▼].
- If an incoming call is being received, you will hear two tones (incoming call tone, p. 61) and the IN USE indicator on the base unit will flash rapidly.  
To answer the call;
  - if using the handset, press [OFF], then press [↶] or [↷].
  - if using the base unit, press [SP-PHONE] twice.

## Answering Intercom Calls

### Handset

When a handset is paged, it rings and the Ringer/Message Alert indicator flashes rapidly. The display shows the calling extension.

#### 1 Press [↶], [↷] or [HOLD/INTERCOM].

- You can also answer a page by pressing any button except [▼], [▲] or [OFF].

Ex. Base calling

Call from Base

Ex. Handset 2 calling

Call from HS[2]

#### 2 To disconnect the intercom, press [OFF].

- If the Auto Talk feature is turned on (p. 21), you can also answer a page by simply lifting the handset off the base unit (or the charger, for accessory handset users, p. 3).

### Base Unit

When the base unit is being paged, it rings and the LOCATOR/INTERCOM/TRANSFER indicator flashes.

#### 1 Press [SP-PHONE] or [LOCATOR/INTERCOM/TRANSFER].

#### 2 To disconnect the intercom, press [SP-PHONE] or [LOCATOR/INTERCOM/TRANSFER].

- When the ringer volume is turned off (p. 18, 19), the handset and the base unit will ring at the low level for intercom calls.
- You cannot change the ringer tone for intercom calls.
- When the base unit user pages all handsets, only the handset user who answers first can talk with the base unit user.

## Intercom

### Voice Paging **Base Unit**

The base unit user can make a voice announcement that is heard through the speakers of all handsets.

- When 4 handsets are registered to the base unit, and if one handset user is on conversation using the Booster feature, 1 of the remaining 3 handsets will not receive the voice announcement.

#### 1 Press [**LOCATOR/INTERCOM/TRANSFER**].

- The LOCATOR/INTERCOM/TRANSFER and SP-PHONE indicators light.

#### 2 To make a voice announcement to all handsets, press [**5**] (*PAGE*).

- You will hear a ringback tone (two short beeps) and the SP-PHONE indicator flashes.

#### 3 When the SP-PHONE indicator stops flashing, speak into the **MIC**.

- All handset users will hear your voice through their speakers after beeps, "Call from Base" will be displayed and the Ringer/Message Alert indicator will flash rapidly on the handsets.
- The handset on the base unit will not be paged.

#### 4 When finished, press [**SP-PHONE**] or [**LOCATOR/INTERCOM/TRANSFER**].

OR

After one of the handsets answers, talk into the **MIC**.

To disconnect the intercom, press [**SP-PHONE**] or [**LOCATOR/INTERCOM/TRANSFER**].

- Only the handset user who answers first can talk with the base unit user.
- To answer the page from the handsets, see "Answering Intercom Calls" on page 50.
- If a handset is too close to the base unit, you may hear feedback while making the voice announcement. Place the handset on the base unit (or the charger, for accessory handset users, p. 3) or press [**OFF**].
- It is not possible to specify which handset(s) will hear the voice announcement.
- The announcement is heard at the handset ringer volume (p. 18).

Telephone System

## Transferring a Call

You can transfer an outside call to the base unit or a handset.

### From the **Handset** to the **Base Unit**

#### 1 Handset:

- (1) During a call, press **[HOLD/INTERCOM]**.
  - The call is put on hold.
- (2) To page the base unit, press **[0]**.
- (3) Wait for the paged party to answer, then you can announce the transfer.
  - If the paged party does not answer, press **[↶]** or **[↷]** to return to the outside call.

Press extension#  
to transfer  
1-4=Handset  
0=Base 9=Mailbox

- #### 2 Base unit:
- Press **[SP-PHONE]** or **[LOCATOR/INTERCOM/TRANSFER]** to answer the page.

- #### 3 Handset:
- To complete the transfer, press **[OFF]**.

### From the **Base Unit** to the **Handset**

#### 1 Base unit:

- (1) During a call, press **[LOCATOR/INTERCOM/TRANSFER]**.
  - The call is put on hold.
- (2) To page a specified handset, press its extension number **[1]** (**/**) to **[4]** (**/**).  
To page all handsets, press **[0]**.  
Wait for the handset user to answer, then you can announce the transfer.  
OR  
To make a voice announcement to all handsets, press **[5]** (**/PAGE**), then speak into the **MIC** when the SP-PHONE indicator stops flashing.
  - If the paged party does not answer, press **[LOCATOR/INTERCOM/TRANSFER]** to return to the outside call.

- #### 2 Handset:
- Press **[↶]**, **[↷]**, or **[HOLD/INTERCOM]** to answer the page.

- You can also answer a page by pressing any button except **[▼]**, **[▲]** or **[OFF]**.

- #### 3 Base unit:
- To complete the transfer, press **[SP-PHONE]**.

- When the base unit user calls all handsets, only the handset user who answers first can take the transferred call.

## Transferring a Call

### From a **Handset** to another **Handset** (when the system has two or more handsets)

**1** During a call, press [**HOLD/INTERCOM**], then page another handset by pressing its extension number ([**1**] to [**4**]).

**2** Wait for the paged party to answer, then you can announce the transfer.

- The paged handset user can answer by pressing [**↶**], [**↷**], or [**HOLD/INTERCOM**]. (Any button except [**▼**], [**▲**] or [**OFF**] can be pressed to answer the page.)
- If the paged party does not answer, press [**↶**] or [**↷**] to return to the outside call.

**3** To complete the transfer, press [**OFF**].

• If the Auto Talk feature is turned on (p. 21), the paged handset user can also answer a page by simply lifting the handset off the base unit (or the charger, for accessory handset users, p. 3).

• Any user can answer a transferred call by pressing [**↶**], [**↷**], or [**SP-PHONE**].

• If you call an extension from the handset in step 1, and the extension is in use, the display will show "Busy" then "Hold".

Press [**↶**] or [**↷**] to return to the outside call.

To transfer the call to another extension, repeat from step 1.

OR

To transfer the call to a mailbox to allow the caller to leave a message, perform the following three steps:

(1) Tell the caller to press the # (pound sign) and the mailbox number of the person they want to leave a message for after you end the call (p. 64).

(2) Press [**HOLD/INTERCOM**].

(3) Press [**9**] to transfer the caller to the Answering System greeting (p. 72).

(The caller will hear the greeting and can select the appropriate mailbox.)

## Transferring a Call

### Quick call transfer

You can transfer a call without waiting for the paged party to answer.

#### Handset

1. During a call, press **[HOLD/INTERCOM]**.
2. Press the extension number (**[0]** for the base unit, **[1]** to **[4]** for the handset).
3. Press **[OFF]** to hang up.

#### Base Unit

1. During a call, press **[LOCATOR/INTERCOM/TRANSFER]**.
  2. Press the extension number **[1]** ( / ) to **[4]** ( / ), or press **[0]** to page all handsets.
  3. Press **[SP-PHONE]** to hang up.
    - The call will be transferred directly.
    - The paged party can answer the transferred call by pressing **[↶]**, **[↷]**, or **[SP-PHONE]**.
    - After the paged party answers, the transfer is complete.
    - If the paged party does not answer:
      - for the handset, press **[↶]** or **[↷]** to return to the outside call.
      - for the base unit, press **[SP-PHONE]** to return to the outside call.
    - If the paged party does not answer within 60 seconds after you hang up, your phone will ring and the call will be returned to your phone. You may speak to the caller again by pressing **[↶]**, **[↷]**, or **[SP-PHONE]**.
- If you do not answer the call within 4 minutes, the call will be disconnected.
- After speaking to the caller, you may also **transfer the caller to a mailbox** by performing the following three steps:
- (1) Tell the caller to press the # (pound sign) and the mailbox number of the person they want to leave a message for after you end the call (p. 64).
  - (2) Press **[HOLD/INTERCOM]** on the handset or **[LOCATOR/INTERCOM/TRANSFER]** on the base unit.
  - (3) Press **[9]** to transfer the caller to the Answering System greeting (p. 72).  
(The caller will hear the greeting and can select the appropriate mailbox.)

## Conference Calls

While you are talking with an outside caller, the base unit user or a handset user can join the conversation and establish a conference call.

### Handset

- 1** During a call, press **[HOLD/INTERCOM]**.
  - The call is put on hold.
- 2** To page the base unit, press **[0]**.  
To page another handset, press the extension number **[1] to [4]**.
- 3** When the paged party answers, press the soft key **(CONF)** on your unit to make a conference call.

### Base Unit

- 1** During a call, press **[LOCATOR/INTERCOM/TRANSFER]**.
  - The call is put on hold.
- 2** To page a handset, press the extension number **[1] (/)** to **[4] (/)**.
- 3** When the paged party answers, press **[CONF]** on your unit to make a conference call.

- To leave the conference, press **[OFF]** on the handset or press **[SP-PHONE]** on the base unit. The two other parties can continue the conversation.
- During a conference, the outside call can be placed on hold by pressing **[HOLD/INTERCOM]** on the handset or **[HOLD]** on the base unit. Internal communications between extensions are not suspended. Only the person who placed the call on hold can resume the full conference by pressing the soft key **(CONF)** on the handset or **[CONF]** on the base unit.
- One more extension can join the conference call. To join the conference call, press **[↶]**, **[↷]**, or **[SP-PHONE]**. A maximum of four parties including the outside party can take part in a conference call.

## Call Share

This feature allows the base unit or the handset to join an existing outside call.

- To prevent other users from joining your conversation, turn the Call Privacy feature on (p. 58).

### To join a conversation (Call Share)

**Handset** Press **[↶]** or **[↷]**.

- "Conference" is displayed.

**Base Unit** Press **[SP-PHONE]**.

- A maximum of four parties including the outside party can join a conversation.

## Room Monitor

This feature allows you to monitor a room by using the intercom feature. For example, you can monitor a baby from different areas of the house. You can call the destination unit to monitor the room. The called unit will not ring. When the system has two or more handsets (p. 3), you can monitor one handset using another. To allow other users to monitor through your unit, turn this feature on. If you want to prevent your unit from being monitored by other extensions, leave this feature off. Using the handset, this feature can be turned on or off separately for the handset and base unit. The factory preset is OFF.

### To turn Room Monitor on for the handset **Handset** (to allow other users to monitor through your handset)

1 Press **[MENU]**.

2 Scroll to "Initial setting" by pressing **[▼]** or **[▲]**, then press the soft key **(SELECT)**.

Initial setting

3 Scroll to "Room monitor" by pressing **[▼]** or **[▲]**, then press the soft key **(SELECT)**.

Room monitor

4 Select "On" by pressing **[▼]** or **[▲]**.

Room monitor  
:On

5 Press the soft key **(SAVE)**, then press **[OFF]**.

- To prevent your handset from being monitored, select "Off" in step 4.

### To turn Room Monitor on for the base unit **Handset** (to allow other users to monitor through your base unit)

1 Follow steps 1 and 2 of "To turn Room Monitor on for the handset" above.

2 Scroll to "Set base unit" by pressing **[▼]** or **[▲]**, then press the soft key **(SELECT)**.

Set base unit

3 Scroll to "Room monitor" by pressing **[▼]** or **[▲]**, then press the soft key **(SELECT)**.

Room monitor

4 Select "On" by pressing **[▼]** or **[▲]**.

Room monitor  
:On

5 Press the soft key **(SAVE)**, then press **[OFF]**.

- To prevent your base unit from being monitored, select "Off" in step 4.



## Room Monitor

### To monitor with **Handset**

The unit to be monitored must not be in use and the handset to be monitored must be off the base unit.

**1** Press **[HOLD/INTERCOM]**, then press the soft key **(MONITOR)**.

**2** To call the base unit, press **[0]**.  
To call another handset, press its extension number (**[1]** to **[4]**).

- To monitor from the speaker, press **[ $\text{Speaker}$ ]**. If the handset is placed on the base unit, monitoring will be stopped. Accessory handset users (p. 3) can place the handset on the charger and continue monitoring. To switch back to the receiver, press **[ $\text{Receiver}$ ]**.

```
Press extension#
for room monitor
1-4=Handset
0=Base
```

```
Room monitor
00-00-05
■ 01
```

**3** To end monitoring, press **[OFF]**.

- The monitored user can stop being monitored by:
  - on the handset, press **[OFF]** or place the handset on the base unit.
  - on the base unit, press **[LOCATOR/INTERCOM/TRANSFER]** or **[SP-PHONE]**.
- “Room monitor” is also displayed on the monitored handset.
- While the base unit is monitoring or being monitored, the LOCATOR/INTERCOM/TRANSFER indicator light flashes and the SP-PHONE indicator lights.

### To monitor with **Base Unit**

The handset to be monitored must not be in use and off the base unit.

**1** Press **[LOCATOR/INTERCOM/TRANSFER]**, then press **[MUTE]**.

- The LOCATOR/INTERCOM/TRANSFER indicator flashes.

**2** To call the handset, press its extension number **[1]** ( $\text{Handset 1}$ ) to **[4]** ( $\text{Handset 4}$ ).

**3** To end monitoring, press **[LOCATOR/INTERCOM/TRANSFER]** or **[SP-PHONE]**.

- The indicator light goes out.

- If the Room Monitor feature of the destination handset is off or the handset is on the base unit, busy tones will sound.

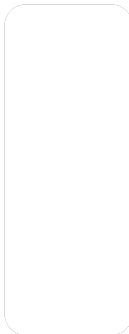

## Special Features

### Muting Your Conversation

During a call, you can mute your phone so the other party cannot listen to you. When muting your conversation, you can hear the other party.

**Handset** Press the soft key (**MUTE**).

- “Mute” will be displayed for a few seconds and “**MUTE**” will flash.
- **To release the mute**, press the soft key (**MUTE**) again.
- If you press [**↶**] or [**↷**] to switch between the receiver and speaker, the mute will be released.

**Base Unit** Press [**MUTE**].

- The SP-PHONE indicator flashes.
- **To release the mute**, press [**MUTE**] again.

### Call Privacy **Handset**

Call Privacy allows you to prevent other users from joining your conversation with an outside caller. To allow other users to join your conversation, leave this feature off. This feature is only available for the handset.

**To turn on the Call Privacy feature:**

Press the soft key (**PRIVACY**) during a conversation.

- “PRIVACY” will be displayed.
- To turn this feature off, press the soft key (**PRIVACY**) again during a conversation.
- While the Call Privacy feature is turned on, other users cannot join the conversation.
- Call Privacy will turn off after you hang up the call.

### Using the PAUSE Button (For PBX Line/Long Distance Calls)

**Handset Base Unit**

We recommend you press the soft key (**PAUSE**) on the handset or press [**REDIAL/PAUSE**] on the base unit if a pause is required for dialling with a PBX or to make a long distance call.

- “**PAUSE**” is displayed on the handset only when dialling before pressing [**↶**] or [**↷**] (p. 30), or storing numbers in the phone book (p. 41).

Ex. Line access number [**9**] (PBX)

[**9**] ➔ Soft key (**PAUSE**) or [**REDIAL/PAUSE**] ➔

- Pressing the soft key (**PAUSE**) on the handset or [**REDIAL/PAUSE**] on the base unit once creates a 3.5 second pause. This prevents misdialling when you dial after confirming the entered number (p. 30) or dial a stored number (p. 43, 44, 48).
- Pressing the soft key (**PAUSE**) on the handset or [**REDIAL/PAUSE**] on the base unit more than once increases the length of the pause between numbers.

## Special Features

### Key Tone **Handset**

You can select whether or not the handset keys will sound tones (key tone, confirmation tone, error tone). The factory preset is ON.

1 Press **[MENU]**.

2 Scroll to "Initial setting" by pressing **[▼]** or **[▲]**, then press the soft key **(SELECT)**.

Initial setting

3 Scroll to "Key tone" by pressing **[▼]** or **[▲]**, then press the soft key **(SELECT)**.

Key tone

4 Select "Off" or "On" by pressing **[▼]** or **[▲]**.

Key tone  
:On

5 Press the soft key **(SAVE)**, then press **[OFF]**.

### Call Waiting and Caller ID Compatible **Handset**

If you subscribe to Caller ID services, your handset displays a second caller's information while talking. After you hear a call-waiting tone, the caller's phone number and "Waiting" will be displayed.

0555666777  
----Waiting----

You can answer the second call, keeping the first call on hold.

Follow Telstra or your service provider instructions using **[RECALL/CALL WAIT]**.

- If the phone number is stored in the phone book, the caller's name will be displayed (p. 34).
- The second caller's information will not be displayed when the answering system is recording someone's message.
- Please contact Telstra or your service provider for details and availability in your area.

#### Using Caller ID Type II

When you receive a second call during a conversation, you will hear a signal tone following the call waiting tone and the **conversation will be interrupted or muted for a short period of time**. This is not fault of the product as these events are normal.

Note: The tones are generated by the telephone company.

Telephone System

## Special Features

### RECALL Button **Handset** **Base Unit**

Pressing [RECALL/CALL WAIT] allows you to use special features of your host PBX such as transferring an extension call, or accessing optional telephone services such as call waiting.

- Pressing [RECALL/CALL WAIT] cancels the mute (p. 58).

### Selecting the recall time **Handset**

The recall time depends on your telephone exchange or host PBX. You can select the following recall times: “700, 600, 400, 300, 250, 110, 100 or 90 ms (milliseconds)”. The factory preset is “100 ms”.

- If PBX functions do not work correctly, consult your PBX supplier for the correct settings.

**1** Press [MENU].

**2** Scroll to “Initial setting” by pressing [▼] or [▲], then press the soft key (SELECT).

Initial setting

**3** Scroll to “Set tel line” by pressing [▼] or [▲], then press the soft key (SELECT).

Set tel line

**4** Scroll to “Set recall time” by pressing [▼] or [▲], then press the soft key (SELECT).

Set recall time

**5** Select the recall time by pressing [▼] or [▲].

Set recall time  
:100ms

**6** Press the soft key (SAVE), then press [OFF].

- You can access Telstra’s “EASY CALL” service by having the recall time set at 100 ms (this is the factory default setting), and then follow Telstra’s “EASY CALL” instructions to operate this service.

## Special Features

### Incoming Call Tone **Handset** **Base Unit**

During an intercom call (p. 49) or while using the Room Monitor feature, you can be informed of incoming calls by two tones.

If this feature is turned on, incoming call tones will be heard for as long as the line is ringing. If this feature is set to "2", incoming call tones will be heard only 2 times. If this feature is turned off, no tones will be heard. This factory preset is "2".

Using the handset, this feature can be set separately for the handset and base unit.

### Handset incoming call tone **Handset**

1 Press **[MENU]**.

2 Press the soft key (**SELECT**) at "Ringer setting".

Ringer setting

3 Scroll to "Incoming call." by pressing **[▼]** or **[▲]**, then press the soft key (**SELECT**).

Incoming call.

4 Select "On", "Off" or "2" by pressing **[▼]** or **[▲]**.

Incoming call  
tone :2

5 Press the soft key (**SAVE**), then press **[OFF]**.

Telephone System

### Base unit incoming call tone **Handset**

1 Press **[MENU]**.

2 Scroll to "Initial setting" by pressing **[▼]** or **[▲]**, then press the soft key (**SELECT**).

Initial setting

3 Scroll to "Set base unit" by pressing **[▼]** or **[▲]**, then press the soft key (**SELECT**).

Set base unit

4 Scroll to "Incoming call." by pressing **[▼]** or **[▲]**, then press the soft key (**SELECT**).

Incoming call.

5 Select "On", "Off" or "2" by pressing **[▼]** or **[▲]**.

Incoming call  
tone :2

6 Press the soft key (**SAVE**), then press **[OFF]**.

## Special Features

### Dial Lock **Handset** **Base Unit**

The dial lock feature allows you to prevent others from making calls with the handset(s) and base unit. You can turn on the dial lock for all the units using a handset. To use this feature, turn the feature on. The factory preset is OFF.

When the dial lock is turned on, only numbers stored in the phone book as emergency numbers (numbers stored with a # at the beginning of the name) can be dialled (p. 41). We recommend storing emergency numbers in the phone book before using this feature.

#### To turn the dial lock on **Handset**

**1** Press **[MENU]**.

**2** Scroll to "Dial lock" by pressing **[▼]** or **[▲]**, then press the soft key **(SELECT)**.

Dial lock

**3** Enter a 4-digit password.

- This password is required when turning the dial lock off.
- If more than 4 digits are entered, the last 4 digits are the password.

Enter password  
: \_\_\_\_

**4** Press the soft key **(SAVE)**.

Enter password  
:1234

**5** Press the soft key **(YES)**.

- "Dial lock on" is displayed.

Turn Dial lock  
on?

**6** Press **[OFF]**.

- If the dial lock is turned on, the handset displays "Dial lock". While there are missed calls, "Dial lock" is not displayed.

- If you make a call while the dial lock is turned on:
  - using the handset, the handset beeps 3 times and "Dial locked" is displayed.
  - using the base unit, the base unit beeps 3 times.
- Please write down your password. If you forget your password, consult your nearest Panasonic service centre.

## Special Features

### To turn the dial lock off **Handset**

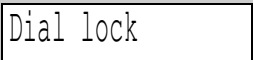
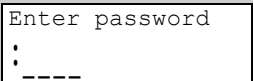
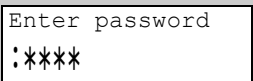
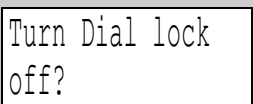
<p><b>1</b> Press <b>[MENU]</b>.</p>	
<p><b>2</b> Scroll to "Dial lock" by pressing <b>[▼]</b> or <b>[▲]</b>, then press the soft key <b>(SELECT)</b>.</p>	
<p><b>3</b> Enter the password set when the dial lock was turned on.</p>	
<p><b>4</b> Press the soft key <b>(SAVE)</b>.</p>	
<p><b>5</b> Press the soft key <b>(YES)</b>.</p> <ul style="list-style-type: none"> <li>• "Dial lock off" is displayed.</li> <li>• If you entered the wrong password, the handset beeps 3 times and "Save error" is displayed. Enter the correct password.</li> </ul>	
<p><b>6</b> Press <b>[OFF]</b>.</p>	

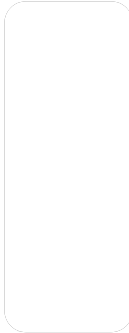

## Mailbox Features

The Answering System provides three voice mailboxes. You can share these mailboxes with other members of your family or office as you wish. Callers from touch tone phones can specify a mailbox in which to leave a message. If callers do not specify a mailbox or call from rotary telephones, messages will be recorded into Mailbox 1.

### When someone calls

When the Answering System is on (p. 66), callers will hear a greeting message (p. 24).

- While or after hearing the greeting, callers can specify a mailbox by pressing **#[1]** (Mailbox 1), **#[2]** (Mailbox 2) or **#[3]** (Mailbox 3). They will then hear “Please leave your message”, and they can start recording a message.
  - If you would like callers to leave messages in a specific mailbox, we recommend you record a greeting message such as: “Hello, this is (your name and/or number). Sorry, we cannot take your call. If you have a message, for John press **#[#]** and **[1]**, for Jane press **#[#]** and **[2]**, for Jack press **#[#]** and **[3]**, before the beep. Or just stay on the line and leave a message after the beep. Thank you.”
- Callers wait until the greeting ends, then they can leave a message. Messages will be automatically recorded into Mailbox 1 if no mailbox is specified.

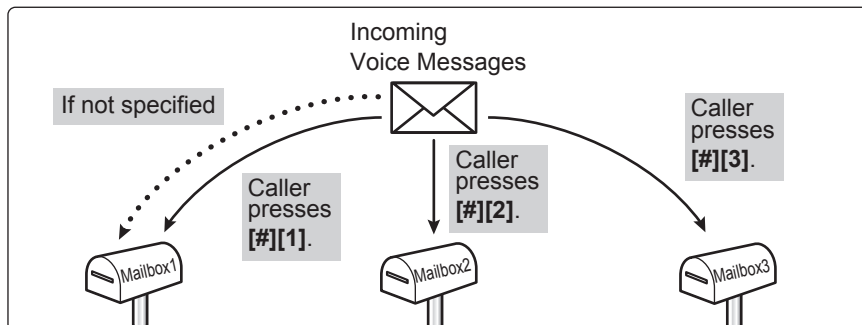

- The total recording time of all messages (greeting, incoming and memo) is **about 16 minutes** (about 8 minutes in “Enhanced recording” mode, p. 28). If messages are recorded in noisy rooms, the time may be shortened by up to 3 minutes.
- To select the caller’s recording time, see page 26.
- A maximum of 64 messages (including the greeting and memo messages) can be recorded.

### Useful information

- You can leave a memo message for other users in a mailbox with the base unit (p. 71).
- You can transfer a call to one of the mailboxes, in which callers can leave a message (p. 72).
- If you want to prevent unauthorized people from listening to messages in Mailbox 2 or 3, you can assign a password to each mailbox (p. 65).



## Mailbox Features

### Setting the Mailbox Password (for Mailbox 2 and 3)

#### Handset

You can use Mailbox 2 or 3 as personal mailboxes. To prevent unauthorized people from accessing your mailbox and listening to your messages, assign a 2-digit password (00–99) to Mailbox 2 or 3. Each password and the remote code (p. 74) must be unique. Once a password is assigned to Mailbox 2 or 3, no one can listen to messages without entering the password.

**1** Press **[MENU]**.

**2** Scroll to “Initial setting” by pressing **[▼]** or **[▲]**, then press the soft key **(SELECT)**.

Initial setting

**3** Press the soft key **(SELECT)** at “Set answering”.

Set answering

**4** Scroll to “Set mailbox2&3” by pressing **[▼]** or **[▲]**, then press the soft key **(SELECT)**.

Set mailbox2&3

**5** Select the mailbox by pressing **[▲]** (Mailbox 2) or **[▼]** (Mailbox 3).

Set password

▲=Mailbox2  
▼=Mailbox3

**6** Enter a **2-digit password (00–99)**.

- If you entered the wrong password, re-enter the correct one.

Ex. Entered 22.

Set password  
Mailbox2 :22

**7** Press the soft key **(SAVE)**.

- If the handset beeps 3 times, you entered the same password as the other mailbox or the remote code (p. 74), or you entered a one-digit password. Start again from step 6 and select another password.

**8** Press **[OFF]**.

**To confirm the password**, repeat steps 1 to 5.

- The password is displayed. When finished, press **[OFF]**.

#### To erase the password

Press the soft key **(CLEAR)** in step 6, press the soft key **(SAVE)**, and press **[OFF]**.

- You can access the mailbox without entering the password.

Answering System

## Automatic Answering Operation

The Answering System allows the unit to answer calls with a greeting message. Callers can then leave a message in a mailbox (p. 64).

### Setting the Unit to Answer Calls **Base Unit**

Press **[ANSWER ON]** to turn on the Answering System.

- The indicator lights and the unit announces “Answer set” and the current day and time. If “Answer set. Set time” is heard, set the date and time (p. 17).
- The unit will announce the remaining recording time if it is less than 3 minutes.
- When no recording time is available, you will need to erase any unnecessary messages before new messages can be recorded (p. 70). The unit can indicate that memory is full in the following ways:
  - “**FULL**” will flash on the base unit and the ANSWER ON indicator will flash rapidly.
  - The unit will announce “Memory full” when you press **[ANSWER ON]**, **[GREETING REC]**, or **[MEMO]**, and after playing back messages or recording a message.
- If you do not want the unit to answer calls, press **[ANSWER ON]** again to turn off the Answering System. The indicator goes out and “Answer off” is heard.
- You can also turn on the Answering System remotely from an outside phone (p. 76).
- If you subscribe to Caller ID (p. 34), Caller ID information automatically adjusts the date and time when a call is received, provided you have already set the date and time manually (p. 17).

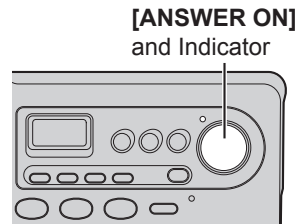

### Monitoring Incoming Calls **Base Unit**

While a caller is leaving a message, you can monitor the call through the base unit speaker.

- To increase the speaker volume while monitoring, press **[▲]**. To decrease volume, press **[▼]**.

To answer a call while monitoring, press **[SP-PHONE]** on the base unit or press **[↶]** or **[↷]** on the handset.

#### To turn the incoming call monitoring feature off

When the base unit is not in use, press **[GREETING CHECK]**, then press **[▼]** repeatedly until “0” is displayed. (Make sure the Answering System is turned on.)  
OR

While monitoring, press **[▼]** repeatedly until “0” is displayed.

- If the incoming call monitoring feature is turned off, it will remain off when the next call is monitored.
- If you adjust the speaker volume while playing back messages or using the speakerphone, the speaker volume for monitoring will be turned on again. To turn the speaker volume off, see “To turn the incoming call monitoring feature off” of above step.

## Listening to Messages

**Voice Day/Time Stamp:** During playback, the unit will announce the day and time when each message was recorded (p. 17).

### Using the Base Unit **Base Unit**

You can see the total number of recorded messages on the base unit display. If the ANSWER ON indicator flashes, new messages have been recorded. The mailbox icons (**BOX1**, **BOX2** and **BOX3**) which have new messages also flash on the base unit display.

Ex. Mailbox 1 has new messages;  
Mailbox 2 has old messages;  
Mailbox 3 has no messages.



- If only old messages exist in a mailbox, the mailbox icon will be displayed but will not flash.
- If the Message Alert is turned on (p. 28), the Ringer/Message Alert indicator on the handset will flash slowly when new messages have been recorded and the handset is not in use.

### To play back messages

Press the MAILBOX button ([MAILBOX 1], [MAILBOX 2], or [MAILBOX 3]).

- The unit announces "Mailbox (No.)" and the number of new messages in the mailbox, then plays back the new messages.
- If the mailbox also contains old messages, only new messages will be played back.
- **When the mailbox has no new messages**, the unit announces "Mailbox (No.)" and "No new messages. All message playback", then plays back all messages in the mailbox.

### When Mailbox 2 or 3 has a password

1. Press [MAILBOX 2] or [MAILBOX 3].

- "Enter Mailbox password" will be heard.

2. Enter the Mailbox password (p. 65).

- The unit announces "Mailbox (No.)" and the number of new messages in the mailbox, then plays back the new messages.
- If the mailbox also contains old messages, only new messages will be played back.
- **When the mailbox has no new messages**, the unit announces "Mailbox (No.)" and "No new messages. All message playback", then plays back all messages in the mailbox.
- During playback, the display shows the message number of the mailbox and the mailbox icon.
- At the end of the last message of the mailbox, "End of final message" is heard. The unit will announce the remaining recording time if it is less than 3 minutes.
- When the mailbox has no messages, the unit announces "Mailbox (No.)" and "No messages".
- If a call is received during playback, the unit rings and playback stops. To answer the call, press [SP-PHONE]. For playback, start again from the beginning after hanging up.

Ex. Mailbox 2

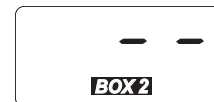

Answering System

## Listening to Messages

### Using the Handset (Remote Operation) **Handset**

If “**PLAY**” flashes, there are new messages. If there are only old messages “**PLAY**” is displayed but will not flash.

- If the Message Alert is turned on (p. 28), the Ringer/Message Alert indicator on the handset will flash slowly when new messages have been recorded and the handset is not in use.

#### To play back messages

##### 1 Press the soft key (**PLAY**).

- A beep sounds and “Please select Mailbox” will be heard from the speaker. To switch to the receiver, press [**↶**]. To switch back to the speaker, press [**↷**].
- The icons for mailboxes that have new messages will flash.

Ex. New messages exist.



##### 2 Press the soft key (**BOX 1**, **BOX 2**, or **BOX 3**).

- If “Enter Mailbox password” is announced and displayed, Mailbox 2 or 3 has a password. Enter the password (p. 65).
- “Mailbox (No.)” and the number of new messages will be announced, and new messages will be played.
- When the mailbox has no new messages, the unit announces “Mailbox (No.)” and “No new messages. All message playback”, and plays back all messages in the mailbox.
- To play all messages in the mailbox, press [**5**].
- If you do not press any button, the voice menu will start (p. 69).

Ex. Mailbox 1 has new messages.

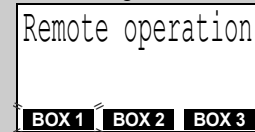

##### 3 To end remote operation, press [**OFF**].

- If you do not select a mailbox in step 2, messages in Mailbox 1 will be played.
- “**PLAY**” will remain on the display after listening to messages.
- You can switch to another mailbox by pressing [**#**] and the mailbox number (**[1]** to **[3]**) during the remote operation.
- If a call is received during playback, the unit rings and playback stops. To answer the call, press [**↶**] or [**↷**]. For playback, start again from the beginning after hanging up.
- At the end of the last message, “End of final message” is heard. The unit will announce the remaining recording time if it is less than 3 minutes.
- If you hear “Memory full” after playback, erase unnecessary messages (p. 70).
- When memo messages are played (p. 71), “MEMO” is displayed.
- When the mailbox has no messages, the unit announces “Mailbox (No.)” and “No messages”.
- During playback, you can turn the Answering System on or off. To turn the system on, press [**8**] during playback. To turn off, press [**0**].

## Listening to Messages

### Voice menu

If you do not press any buttons at the end of the last message, the unit will announce "End of final message" and the voice menu will begin.

The unit announces, "Press 4 to play back new messages. Press 5 to play back all messages."

- You can press buttons for other playback options (see below) or select another mailbox by pressing [#] and the mailbox number ([1] to [3]) even if the voice menu has started.
- If you do not press any button within 10 seconds after the voice menu, the handset will exit remote operation.

#### For Caller ID service users (p. 34)

During playback, the handset display shows the name and/or number of the caller whose message is being played.

#### To call the displayed number:

1. Press the soft key (**CALL**).
  - The unit stops playback.
  - If you need to edit the phone number to call back, see page 39.
2. Press the soft key (**CALL**), [**↶**], or [**↷**].
  - The unit dials the phone number.

### During playback **Base Unit** **Handset**

<b>To adjust the speaker volume</b>	To increase, press [ <b>▲</b> ]. To decrease, press [ <b>▼</b> ]. • You can also adjust the receiver volume on the handset.
<b>To repeat a message</b>	<i>Base unit:</i> Press [ <b>◀◀</b> ]. <i>Handset:</i> Press the soft key ( <b>REPEAT</b> ) or [ <b>1</b> ]. • If pressed within the first 5 seconds of playback, the previous message will be played.
<b>To skip a message</b>	<i>Base unit:</i> Press [ <b>▶▶</b> ]. <i>Handset:</i> Press the soft key ( <b>SKIP</b> ) or [ <b>2</b> ].
<b>To stop playback</b>	<i>Base unit:</i> Press [ <b>STOP</b> ]. • To resume playback, press the MAILBOX button ( <b>MAILBOX 1</b> , <b>MAILBOX 2</b> , or <b>MAILBOX 3</b> ) of the message that is being played. • If you do not press any button for 60 seconds or if you press [ <b>STOP</b> ] again, playback mode will be cancelled. <i>Handset:</i> Press [ <b>9</b> ]. • If you do not press any button within 15 seconds after stopping playback, the voice menu will start (see above).

Answering System

## Erasing Messages

The unit will announce the remaining recording time after playback if it is less than 3 minutes. New messages cannot be recorded when:

- “Memory full” is heard.
  - “**FULL**” flashes on the base unit.
  - ANSWER ON indicator flashes rapidly (when the Answering System is on).
- Erase unnecessary messages. We recommend you erase unnecessary messages after each playback.

### Erasing a specific message

#### Base Unit

Press **[ERASE]** while the message you want to erase is being played.

- A beep sounds, then the next message is played. To exit playback mode, press **[STOP]** twice.

#### Handset

Press **[\*][4]** while the message you want to erase is being played.

- A beep sounds, then the next message is played. To exit remote operation mode, press **[OFF]**.

### Erasing all messages in the mailbox

All recorded messages, except the greeting message, can be erased at one time.

#### Base Unit

**1** Press **[ERASE]** while the base unit is not being used.

- “To erase all messages, please select Mailbox” is heard.

**2** Within 10 seconds, press the MAILBOX button (**[MAILBOX 1]**, **[MAILBOX 2]**, or **[MAILBOX 3]**).

- You can also select the mailbox by pressing the mailbox number (**[1]** to **[3]**).
- If Mailbox 2 or 3 has a password, enter it (p. 65).
- A long beep sounds, then “Mailbox (No.)” and “No messages” are heard.

#### Handset

**1** Press the soft key (**PLAY**).

**2** Press the soft key (**BOX1**, **BOX2**, or **BOX3**).

- If Mailbox 2 or 3 has a password, enter it (p. 65).

**3** Press **[\*][5]** to erase all messages in the mailbox.

- A long beep sounds, then “Mailbox (No.)” and “No messages” are heard.
- To end remote operation, press **[OFF]**.

- Information in the Caller List will not be erased. To erase caller information, see page 40.

## Recording a Memo Message

### Base Unit

You can record a voice memo message of up to 3 minutes in the desired mailbox for other users or yourself.

**1** Press **[MEMO]**.

- “Please select Mailbox” is heard.

**2** Within 10 seconds, press a MAILBOX button (**[MAILBOX 1]**, **[MAILBOX 2]** or **[MAILBOX 3]**).

- You can also select a mailbox by pressing the mailbox number (**[1]** to **[3]**).

After the long beep, talk clearly 20 cm away from the **MIC**.

- The base unit display shows the elapsed recording time.
- If the elapsed recording time exceeds 99 seconds, the counter continues from 00 to indicate 100 seconds.

**3** When finished, press **[MEMO]** or **[STOP]**.

- The ANSWER ON indicator, the mailbox icon (**BOX1**, **BOX2** or **BOX3**) on the base unit and “**PLAY**” on the handset flash.

- If you record for over 3 minutes in step 2, the unit will stop recording.
- If “E” is displayed, 6 beeps sound and “Your message was not recorded. Record your message again.” is announced, start again from step 1.

Answering System

## Transferring a Call to a Mailbox

### Base Unit Handset

When you answer a call and the caller wants to talk to someone who is not available, you can place the caller into one of the mailboxes, where the caller can leave a message.

Tell the outside caller you will transfer him or her to the desired party's mailbox. Remind the caller to press # (the pound sign) and the mailbox number of the desired party (if necessary).

#### 1 Base unit:

Press **[LOCATOR/INTERCOM/TRANSFER]** during a call.

*Handset:* Press **[HOLD/INTERCOM]** during a call.

- The call is put on hold.

#### Handset display

```
Press extension#
to transfer
1-4=Handset
0=Base 9=Mailbox
```

#### 2 Press **[9]** to hang up the call.

##### After you press **[9]**:

The caller will then hear the greeting (p. 24), and while that message is playing the caller can press **[#]** and the mailbox number (**[1]** to **[3]**). Then the caller will hear "Please leave your message". The caller can leave a message in the mailbox.

OR

If the caller does not specify the mailbox, the caller can leave a message in Mailbox 1 after the greeting.

- Even if you subscribe to Caller ID service (p. 34), Caller ID information will not be displayed while the message is being played. The Caller ID information will be recorded in the Caller List (p. 37) if the transferred call is an incoming call.

### Interrupting remote operation

If another user is calling from a remote location to access a mailbox and you mistakenly answer the call, repeat steps 1 and 2 above.

- The user can then access a mailbox, by entering the remote code or the mailbox password (see "Remote Operation from a Touch Tone Phone" on page 73).



## Remote Operation from a Touch Tone Phone

While outside, you can operate the Answering System from any touch tone phone. A synthesized voice menu will guide you through the Answering System (p. 75).

- To skip the voice menu and operate the unit directly, see page 76.



### Summary of remote operation

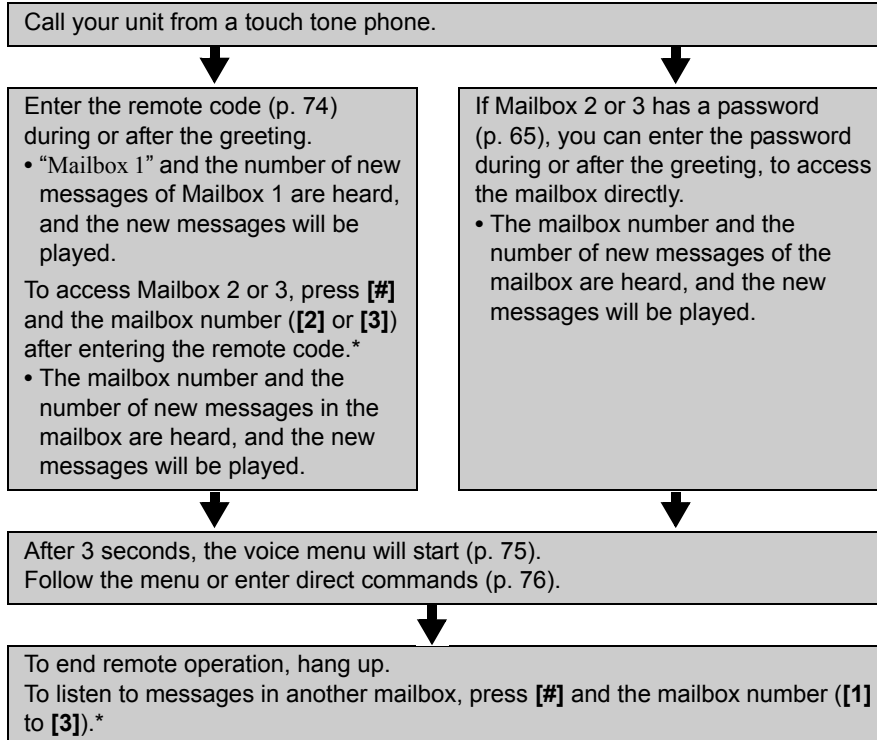

Answering System

- \* If you hear "Enter Mailbox password" after selecting mailbox 2 or 3, enter the password for the mailbox.
- The unit will announce the remaining recording time after playback if it is less than 3 minutes.
- The messages are saved.
- If the unit announces "No new messages", the mailbox has only old messages. If "No messages" is announced, the mailbox has no messages.

## Remote Operation from a Touch Tone Phone

### Remote Code **Handset**

The remote code prevents unauthorized people from accessing your unit and listening to your messages. Choose any **2-digit number (00–99)** for your remote code.

The factory preset remote code is "11". If you do not program your own remote code, you can use "11".

**1** Press **[MENU]**.

**2** Scroll to "Initial setting" by pressing **[▼]** or **[▲]**, then press the soft key **(SELECT)**.

Initial setting

**3** Press the soft key **(SELECT)** at "Set answering".

Set answering

**4** Scroll to "Remote code" by pressing **[▼]** or **[▲]**, then press the soft key **(SELECT)**.

Remote code

**5** Enter a **2-digit remote code (00–99)**.

Ex. Entered 35.

Remote code  
:35

**6** Press the soft key **(SAVE)**.

- If the handset beeps 3 times, the entered remote code is the same as the password (p. 65) and cannot be used. Start again from step 5 and select another code.

**7** Press **[OFF]**.

**To confirm the remote code**, repeat steps 1 to 4.

- The remote code is displayed. When finished, press **[OFF]**.

## Remote Operation from a Touch Tone Phone

### Voice Menu

The shaded parts are voice prompts.

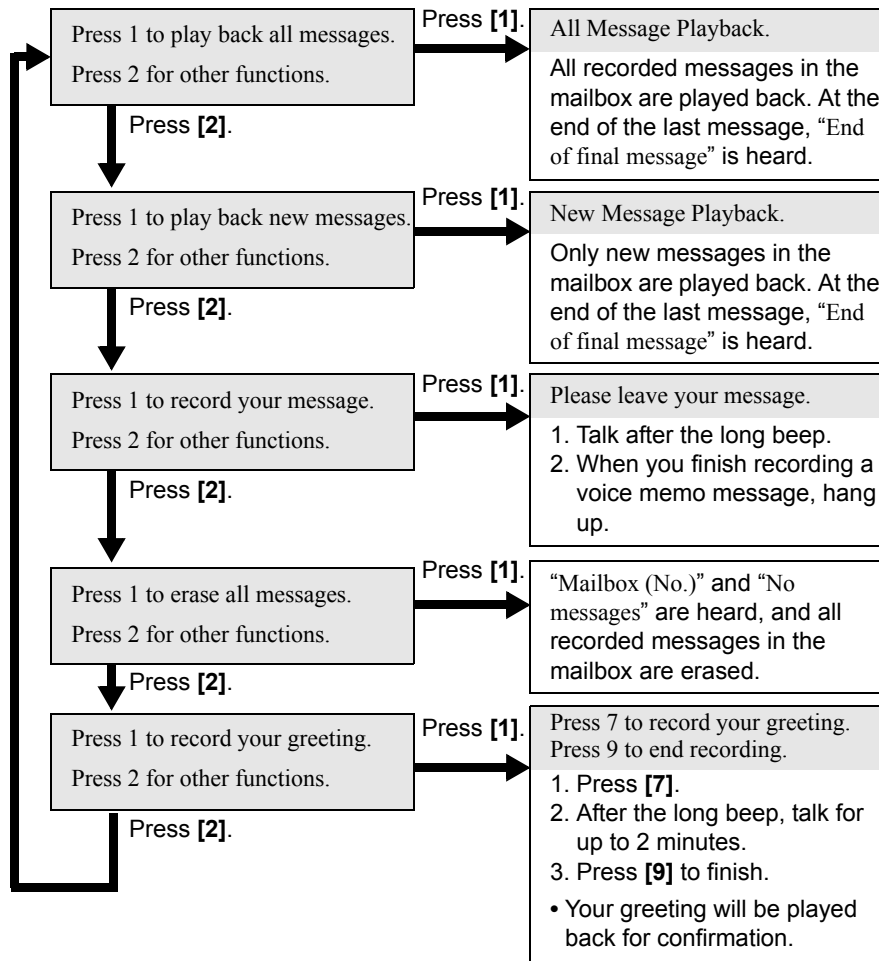

- 3 seconds after playback, the voice menu will start again from the beginning.
- The unit will announce the remaining recording time after playback if it is less than 3 minutes.
- If you hear "Memory full" after playback, erase unnecessary messages (p. 76).
- To switch to another mailbox to listen to messages, press [#] and the mailbox number ([1] to [3]) during remote operation. If you hear "Enter Mailbox password", Mailbox 2 or 3 has a password (p. 65) which must be entered.
- If you do not press any buttons within 10 seconds after a voice prompt, "Thank you for your call" will be heard and the call will be disconnected.

## Remote Operation from a Touch Tone Phone

### Direct Remote Operation

Once you have accessed one of the mailboxes (p. 73), you can also control your unit by direct commands instead of using the voice menu. To end the remote operation, hang up at anytime.

#### Direct commands

<b>[4]:</b> Plays back new messages.	<b>[*] [4]:</b> Erases the current message. • A beep will sound and the next message will be played.
<b>[5]:</b> Plays back all messages.	<b>[*] [5]:</b> Erases all messages in the mailbox. • A long beep will sound, and "Mailbox (No.)" and "No messages" will be heard.
<b>[1]:</b> Repeats the current message. • If pressed within the first 5 seconds of playback, the previous message will be played.	<b>[#] [1]:</b> Selects Mailbox 1.
<b>[2]:</b> Skips the current message.	<b>[#] [2]:</b> Selects Mailbox 2.
<b>[9]:</b> Stops the current operation. • To resume, enter a direct command within 15 seconds, or the voice menu will start (p. 75).	<b>[#] [3]:</b> Selects Mailbox 3. • If Mailbox 2 or 3 has a password (p. 65), enter it.
<b>[7]:</b> Records a greeting message. ↓ After the long beep, talk for up to 2 minutes.	<b>[0]:</b> Turns off the Answering System. • The unit hangs up.
<b>[9]:</b> Recording is stopped. • The greeting is played.	

### Turning on the Answering System

Call your unit and wait for 15 rings.

- The unit will answer and the greeting will be played.
- The Answering System will be turned on. Hang up or enter the remote code for other options.
- When turning on the Answering System using a rotary or pulse service telephone, you cannot enter the remote code for other options.

### Skipping the greeting

After calling your unit, press [\*] during the greeting.

- The unit skips the rest of the greeting and you can start recording your message after the long beep.

## Belt Clip

You can hang the handset on your belt or pocket using the included belt clip.

### To attach the belt clip

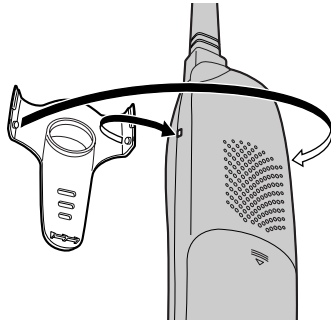

### To remove the belt clip

While pressing the top of the clip (A), pull the right edge in the direction of the arrow (B).

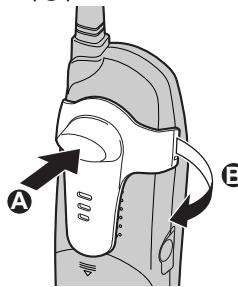

## Optional Headset

Connecting an optional headset to the handset allows hands-free phone conversation. Please use only the Panasonic KX-TCA88AL headset.

Only telecommunications compliance labelled headsets should be plugged into the headset jack on the handset.

### Connecting the optional headset

Open the headset jack cover, and insert the headset plug into the headset jack as shown below.

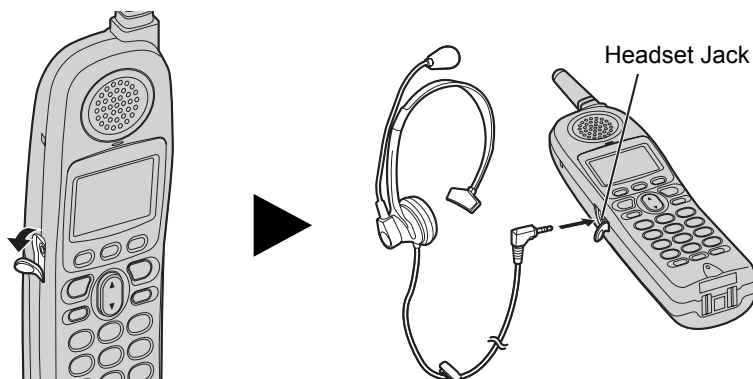

**To switch to the speakerphone while using the headset:**  
Press [M]. To return to the headset, press [M].

Useful Information

## Wall Mounting

This unit can be mounted on a wall.

- 1 Connect the AC adaptor.

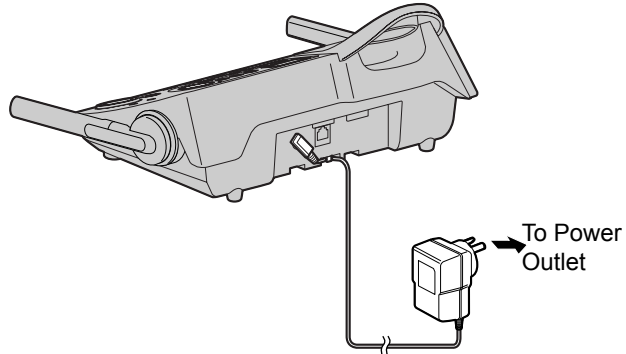

- 2 Tuck the telephone line cord inside the wall mounting adaptor (1).  
Connect the telephone line cord (2).

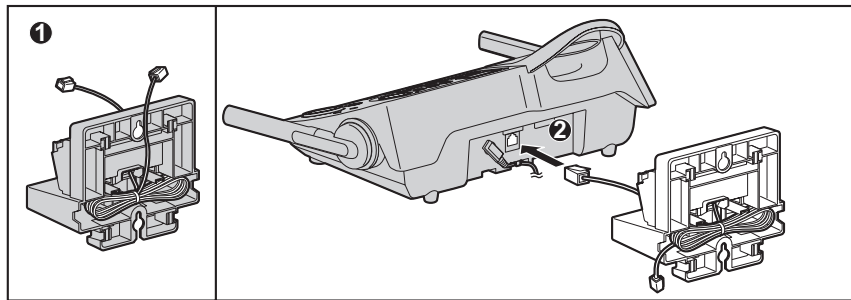

- 3 Insert the hooks on the wall mounting adaptor into the holes (A) and (B) on the base unit.

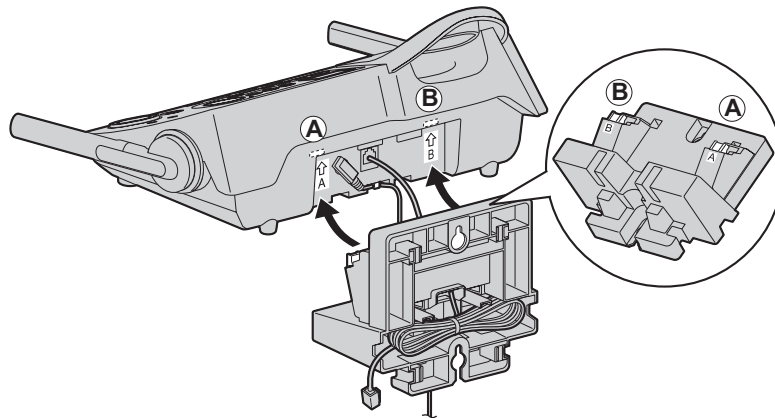

## Wall Mounting

- 4** Adjust the adaptor to hold the base unit, then push it in the direction of the arrow until it clicks into place.

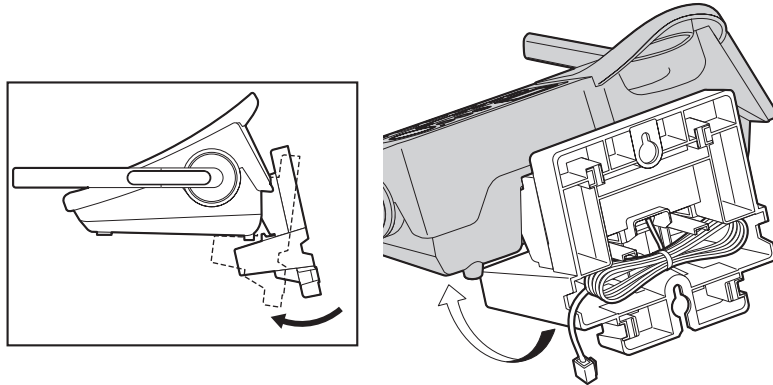

- 5** Install screws using the wall template below. Connect the telephone line cord. Mount the unit, then slide down.

- Raise the antennas.

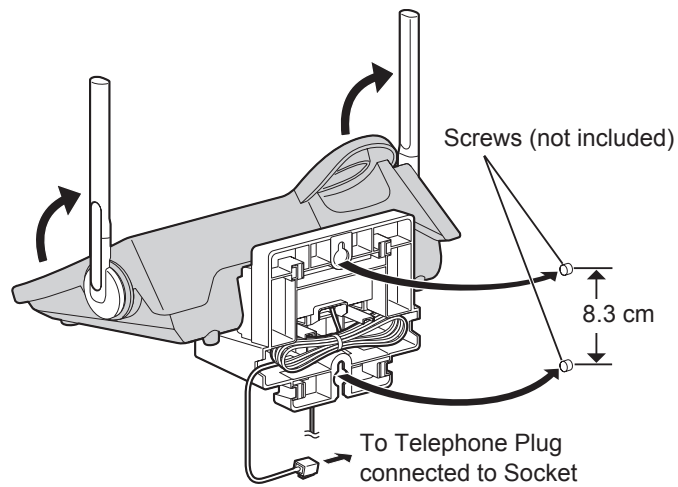

- 6 To charge the handset battery:**

Place the handset on the base unit.

- The unit beeps once and the CHARGE indicator lights.

### Wall Template

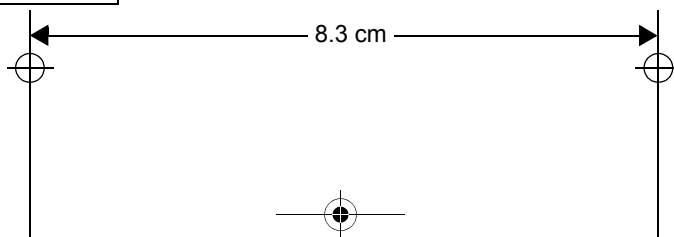

## Wall Mounting

### To remove the wall mounting adaptor

While pushing down the RELEASE LEVERS (1), remove the adaptor (2).

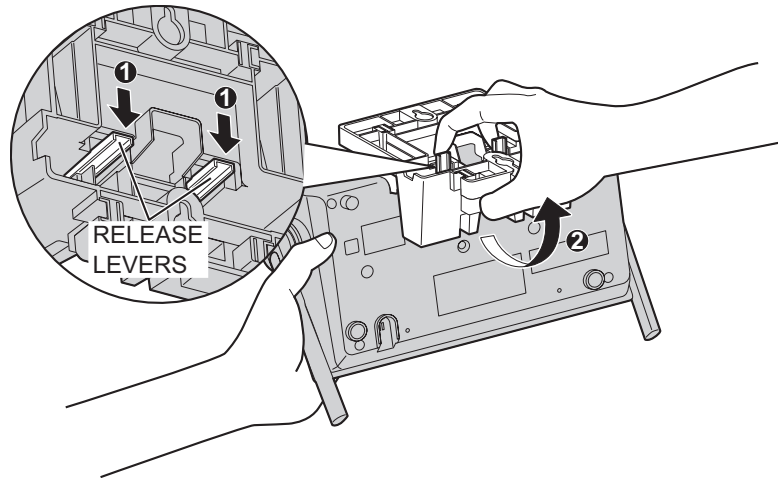



## Direct Commands

### Handset

After pressing **[MENU]**, you can also program menu items directly by pressing **[0]** to **[9]**, **[\*]** and **[#]** instead of using the soft keys.

Menu item	Command	Selection items	Page
Ringer volume	<b>[1] [1]</b>	<b>[0]</b> : Off <b>[1]</b> : Low <b>[2]</b> : Medium <b>[3]</b> : High	p. 18
Ringer tone (Handset)	<b>[1] [2]</b>	<b>[1]–[3]</b> : Tone pattern 1–3 <b>[4]–[7]</b> : Melody pattern 1–4	p. 19
Incoming call tone (Handset)	<b>[1] [3]</b>	<b>[1]</b> : On <b>[2]</b> : Twice <b>[0]</b> : Off	p. 61
Date and time	<b>[4]</b>	Go to Step 3 on page 17.	–
Voice enhancer	<b>[5]</b>	<b>[1]</b> : On <b>[0]</b> : Off	p. 31
Dial lock	<b>[6]</b>	Go to Step 3 on page 62.	–
Talking Caller ID (Handset)	<b>[9]</b>	<b>[1]</b> : On <b>[0]</b> : Off	p. 35
Copy phone book –Copy 1 item	<b>[#] [1]</b>	Go to Step 4 on page 46.	–
Copy phone book –Copy all items	<b>[#] [2]</b>	Go to Step 4 on page 47.	–
LCD contrast	<b>[0] [1]</b>	<b>[1]–[6]</b> : Level 1–6	p. 21
Key tone	<b>[0] [2]</b>	<b>[1]</b> : On <b>[0]</b> : Off	p. 59
Auto talk	<b>[0] [3]</b>	<b>[1]</b> : On <b>[0]</b> : Off	p. 21
Set area code	<b>[0] [4]</b>	Go to Step 4 on page 22.	–
Set dial mode	<b>[0] [5] [1]</b>	<b>[2]</b> : Tone	p. 23
Set recall time	<b>[0] [5] [2]</b>	<b>[1]</b> : 700 ms <b>[2]</b> : 600 ms <b>[3]</b> : 400 ms <b>[4]</b> : 300 ms <b>[5]</b> : 250 ms <b>[6]</b> : 110 ms <b>[7]</b> : 100 ms <b>[8]</b> : 90 ms	p. 60
Set line mode	<b>[0] [5] [3]</b>	<b>[1]</b> : A <b>[2]</b> : B	p. 23
Number of rings	<b>[0] [6] [1]</b>	<b>[2]–[7]</b> : 2–7 rings <b>[0]</b> : Toll saver	p. 27
Recording time	<b>[0] [6] [2]</b>	<b>[1]</b> : 1 minute <b>[2]</b> : 2 minutes <b>[3]</b> : 3 minutes <b>[0]</b> : Greeting only	p. 26
Remote code	<b>[0] [6] [3]</b>	Go to Step 5 on page 74.	–
Recording mode	<b>[0] [6] [4]</b>	<b>[1]</b> : Standard recording <b>[2]</b> : Enhanced recording	p. 28

## Direct Commands

Menu item	Command	Selection items	Page
Mailbox 2&3 passwords	[0] [6] [5]	Go to Step 5 on page 65.	–
Room monitor (Handset)	[0] [9]	[1] : On [0] : Off	p. 56
Message alert	[0] [#]	[1] : On [0] : Off	p. 28
Ringer tone (Base unit)	[0] [*] [1]	[1]–[3] : Tone pattern 1–3 [4]–[7] : Melody pattern 1–4	p. 20
Incoming call tone (Base unit)	[0] [*] [2]	[1] : On [2] : Twice [0] : Off	p. 61
Room monitor (Base unit)	[0] [*] [3]	[1] : On [0] : Off	p. 56
Talking Caller ID (Base unit)	[0] [*] [4]	[1] : On [0] : Off	p. 36
Handset registration	[0] [0] [1]	Go to Step 5 on page 84.	–
Handset deregistration	[0] [0] [2]	[3] [3] [5]	p. 83

### During programming:

When "**SAVE**" or "**OK**" is displayed, press the right soft key to **save the new settings**.

**To exit programming**, press **[OFF]**.

- If you press the direct command incorrectly, press **[OFF]**, then re-enter programming mode by pressing **[MENU]**.
- For function details, see the corresponding pages.

## Cancelling Registration/Re-registration

### Cancelling the Handset Registration **Handset**

If you no longer need to use the handset or if you want to use the handset with a different base unit of the same model, it is necessary to cancel the handset's registration from the current base unit.

Only one handset can be cancelled at a time.

**Make sure the handset and the base unit near each other and are not being used.**

1 Press **[MENU]**.

2 Scroll to "Initial setting" by pressing **[▼]** or **[▲]**, then press the soft key **(SELECT)**.

Initial setting

3 Scroll to "Registration" by pressing **[▼]** or **[▲]**, then press the soft key **(SELECT)**.

Registration

4 Scroll to "Deregistration" by pressing **[▼]** or **[▲]**, then press the soft key **(SELECT)**.

Deregistration

5 Press **[3][3][5]** to delete the registration memory.

- If you enter a wrong code, re-enter **[3][3][5]**.

Deregistration  
Enter code:335  
:335

6 Press the soft key **(OK)**.

- The registration memory will be erased on both the handset and the base unit.
- If the handset beeps 3 times, you entered a wrong code. Enter "335", then press the soft key **(OK)**.
- To register the handset to another base unit of the same model, start from step 5 on page 84.

Ex. Extension number 2

Handset [2] [-]  
Deregistered

- "[-]" is shown on the top right of the display.
- After cancelling registration, the handset cannot be used. If you want to use it again, register the handset to the base unit by performing steps 5 and 6 on page 84.

## Cancelling Registration/Re-registration

### Re-registering the Handset **Handset & Base Unit**

If you want to re-register the handset to the base unit or a different base unit of the same model, you need to register it to that base unit. The handset will be given a new extension number of that base unit. Only one handset can be registered at a time near the base unit.

**Make sure the base unit and the other handsets are not being used. Have both the handset and base unit nearby during registration.**

If you have cancelled handset registration at a previous base unit (p. 83), start from step 5.

**1 Handset:** Press **[MENU]**.

**2 Handset:** Scroll to "Initial setting" by pressing **[▼]** or **[▲]**, then press the soft key **(SELECT)**.

Initial setting

**3 Handset:** Scroll to "Registration" by pressing **[▼]** or **[▲]**, then press the soft key **(SELECT)**.

Registration

**4 Handset:** Press the soft key **(SELECT)** at "HS registration".

HS registration

**5 Base unit:**

Press and hold **[LOCATOR/INTERCOM/TRANSFER]** for 3 seconds.

- The CHARGE indicator flashes. After the CHARGE indicator starts flashing, the rest of the procedure must be completed within 1 minute.

**6 Handset:**

- (1) Press the soft key **(OK)**.
- (2) Wait until a long beep sounds and the display shows the new extension number (ex. extension number 2).

- Registration is complete.

Press LOCATOR  
on base unit  
for 3 sec.  
Then press OK

Handset [2]  
Registered

- You can stop registration by pressing **[OFF]** on the handset and pressing **[LOCATOR/INTERCOM/TRANSFER]** on the base unit.

## Cancelling Registration/Re-registration

If you have not cancelled the handset's registration at the previous base unit (p. 83), the handset number remains in that base unit's memory. To erase the handset number from the previous base unit, see the base unit's Operating Instructions. For the KX-TG5240AL base unit: (1) Press and hold **[LOCATOR/INTERCOM/TRANSFER]** for 3 seconds, and (2) Press and hold the handset number **[1]** to **[4]** that you do not want for 5 seconds. A long beep sounds, then the handset number is erased.

## If the Following Appear on Your Display...

The following will be displayed on the handset when the unit needs your attention.

Display message	Cause & Remedy
Recharge battery	<ul style="list-style-type: none"> <li>The battery needs to be charged. Recharge the battery (p. 14).</li> </ul>
Charge for 6 HRS	<ul style="list-style-type: none"> <li>The battery has been discharged. The handset will not work. Fully charge the battery (p. 14).</li> </ul>
No link to base. Move closer to base and try again.	<ul style="list-style-type: none"> <li>The handset has lost communication with the base unit. Walk closer to the base unit, and try again.</li> <li>Confirm the base unit's AC adaptor is plugged in.</li> <li>Raise the base unit antennas.</li> <li>The handset's registration may have been cancelled. Re-register the handset(p. 83, 84).</li> </ul>
Please lift up and try again.	<ul style="list-style-type: none"> <li>A handset button was pressed while the handset was on the base unit (or the charger, for accessory handset users, p. 3). Lift the handset and press the button again.</li> </ul>
Busy	<ul style="list-style-type: none"> <li>The called base unit or handset is in use.</li> <li>Privacy mode is on for the call you tried to join (p. 58).</li> <li>The handset you tried to send phone book items to is in use.</li> <li>The handset you are calling is too far from the base unit.</li> </ul>
Invalid	<ul style="list-style-type: none"> <li>The called handset has not been registered to the base unit.</li> <li>You selected your own extension number.</li> </ul>

Useful Information

## If the Following Appear on Your Display...

Display message	Cause & Remedy
Error!!	<ul style="list-style-type: none"> <li>• When you tried to register or deregister the handset, the handset and base unit could not link for some reason, such as interference from electrical appliances. Move the handset and base unit away from any electrical appliances and try again.</li> <li>• If more than one handset is in use, you may not be able to register/deregister. Try again later.</li> <li>• Another handset tried to send phone book items to you but copying stopped. Have the other handset user re-send the items to you (p. 46, 47).</li> </ul>
System is busy. Please try again later.	<ul style="list-style-type: none"> <li>• If more than one other user is using the handset and/or base unit, such as conducting outside/intercom calls or listening to messages, you may not be able to use the handset. Try again later.</li> <li>• The Answering System is in use (answering a call or playing back messages). Try again later.</li> <li>• The handset has lost communication with the base unit. Walk closer to the base unit and try again.</li> </ul>
Phone book full	<ul style="list-style-type: none"> <li>• When you tried to store an item in the phone book, the phone book memory was full. Press <b>[OFF]</b> to exit programming mode. To erase other items from the phone book, see page 45.</li> </ul>
---Incomplete--- Tom Jones 0987654321 Phone book full (The name/number is an example.)	<ul style="list-style-type: none"> <li>• When the displayed item was sent to the destination handset, the phone book memory was full and copying stopped. If you tried to send all of the items, the item displayed with "Incomplete" and items after it have not been copied to the destination handset. Press <b>[OFF]</b> to exit (p. 46, 47). To erase items from the destination handset phone book, see page 45. You can copy all of the items again or copy the items which have not been copied one by one (p. 46, 47).</li> </ul>
---Incomplete--- Tom Jones 0555654321 (The name/number is an example.)	<ul style="list-style-type: none"> <li>• The destination handset is out of area.</li> <li>• The destination handset user may have pressed <b>[↶]</b> or <b>[↷]</b>.</li> </ul>
Phone book No items stored	<ul style="list-style-type: none"> <li>• Your phone book is empty. No items were copied to the destination unit.</li> </ul>

## If the Following Appear on Your Display...

Display message	Cause & Remedy
Denied	<ul style="list-style-type: none"> <li>• The Room Monitor feature is turned off on the destination handset or base unit and cannot be monitored (p. 56).</li> <li>• The called handset was on the base unit. The handset must be off the base unit to be monitored.</li> </ul>
Save error	<ul style="list-style-type: none"> <li>• The entered password was wrong in programming the dial lock. Enter the correct password.</li> </ul>
Dial locked	<ul style="list-style-type: none"> <li>• The dial lock is turned on. If necessary, turn the dial lock off (p. 63).</li> </ul>
Invalid. Please register to the base unit	<ul style="list-style-type: none"> <li>• The handset you tried to call has not been registered to the base unit. Register the handset (p. 84, steps 5 and 6).</li> </ul>
Error!! 4 handsets have already been registered.	<ul style="list-style-type: none"> <li>• 4 handsets have already been registered to the base unit. To cancel a handset's registration, see page 83.</li> <li>• You may have registered one of your handsets to another base unit without deleting its registration to this base unit. Erase the handset's registration from the base unit. For the KX-TG5240AL base unit: (1) Press and hold [<b>LOCATOR/INTERCOM/TRANSFER</b>] for 3 seconds, and (2) Press and hold the handset number [<b>1</b>] (<i>/</i>) to [<b>4</b>] (<i>/</i>) that you do not want for 5 seconds. A long beep sounds, then the handset number is erased.</li> </ul>

# Troubleshooting



If the handset display shows error messages, see “If the Following Appear on Your Display...” (p. 85–87) for the Cause & Remedy.

## Telephone System

Problem	Cause & Remedy
<p>“No link to base. Move closer to base and try again.” is displayed and an alarm tone sounds.</p>	<ul style="list-style-type: none"> <li>• The handset has lost communication with the base unit. Walk closer to the base unit, and try again.</li> <li>• Confirm the base unit’s AC adaptor is plugged in.</li> <li>• Raise the base unit antennas.</li> <li>• The handset’s registration may have been cancelled. Re-register the handset (p. 84).</li> </ul>
<p>Static, sound cuts in/out, fades. Interference from other electrical units.</p>	<ul style="list-style-type: none"> <li>• Move the handset and base unit away from other electrical appliances (p. 6).</li> <li>• Walk closer to the base unit.</li> <li>• Raise the base unit antennas.</li> <li>• Turn on the Clarity Booster feature (p. 31).</li> <li>• Your unit is connected to a telephone line with ADSL service. We recommend connecting a noise filter (contact your ADSL service provider) to the telephone line between the base unit and the telephone line jack.</li> </ul>
<p>The base unit and/or handset does not ring.</p>	<ul style="list-style-type: none"> <li>• The ringer volume is turned off. Set to high, medium, or low (p. 18, 19).</li> <li>• If more than one other user is using the handset and/or base unit, the handset/base unit may not ring. Users will hear incoming call tones (p. 61).</li> </ul>
<p>The handset display is blank.</p>	<ul style="list-style-type: none"> <li>• If the handset display is blank, fully charge the battery (p. 13).</li> </ul>
<p>You cannot program any function items.</p>	<ul style="list-style-type: none"> <li>• Programming is not possible while the handset and/or base unit is being used.</li> <li>• Do not pause for over 60 seconds while programming.</li> <li>• Walk closer to the base unit.</li> <li>• While another user is listening to messages or the Answering System is handling a call, you cannot program. Try again later.</li> <li>• When the dial lock is turned on, you cannot store phone numbers (p. 41, 48). To turn the mode off, see page 63.</li> </ul>



## Troubleshooting

Problem	Cause & Remedy
While programming or searching, the handset or base unit starts to ring and the program/search stops.	<ul style="list-style-type: none"> <li>• A call is coming in. To answer the call, press <b>[]</b>, <b>[]</b> or <b>[SP-PHONE]</b>. Start again from the beginning after hanging up.</li> </ul>
You cannot make an intercom/ outside call.	<ul style="list-style-type: none"> <li>• If more than one other user is using the handset and/or base unit, you may not be able to make a call. Try again later.</li> <li>• Your handset is in remote operation mode (p. 68). Exit by pressing <b>[OFF]</b>.</li> <li>• The handset you called is too far from the base unit.</li> <li>• You cannot make an outside call when the dial lock is turned on. To turn the mode off, see page 63.</li> <li>• Set the dialling mode to "Tone" (p. 23).</li> </ul>
You cannot redial.	<ul style="list-style-type: none"> <li>• If the last number dialled was more than 48 digits long, the number will not be redialled correctly.</li> <li>• The <b>[REDIAL/PAUSE]</b> button on the base unit functions as either redial or pause. It will redial the last number dialled if pressed before dialling any digits (p. 32). If another number has been dialled first, it will operate as a pause button (p. 58).</li> <li>• You cannot redial when the dial lock is turned on. To turn the mode off, see page 63.</li> </ul>

## Troubleshooting

Problem	Cause & Remedy
<p>The handset does not display the caller's phone number.</p>	<ul style="list-style-type: none"> <li>• You need to subscribe to Caller ID.</li> <li>• Other telephone equipment may be interfering with your phone. Disconnect it and try again.</li> <li>• Other electrical appliances connected to the same outlet may be interfering with Caller ID.</li> <li>• Telephone line noise may be affecting Caller ID.</li> <li>• The caller requested not to send his/her Caller ID information (p. 34).</li> <li>• If a call is being transferred to you, the Caller ID information will not be displayed.</li> <li>• If a (separate) Caller ID box is connected between the base unit and the telephone wall jack, disconnect the Caller ID box or plug the unit directly into the wall jack.</li> <li>• Some of PBX units may not support Caller ID. Please consult with your PBX supplier.</li> <li>• The calling party does not subscribe to Caller ID services.</li> <li>• Your unit is connected to a telephone line with ADSL service. We recommend connecting a noise filter (contact your ADSL service provider) to the telephone line between the base unit and the telephone line jack.</li> </ul>
<p>The handset and/or base unit does not announce the displayed caller's name.</p>	<ul style="list-style-type: none"> <li>• The handset and/or base unit ringer volumes are turned off. Set to high, medium, or low (p. 18, 19).</li> <li>• The Talking Caller ID feature is turned off. Turn it on (p. 35).</li> </ul>
<p>The handset and/or base unit does not announce the displayed caller's name properly.</p>	<ul style="list-style-type: none"> <li>• Name pronunciation may vary.</li> <li>• The handset and/or base unit will announce each letter of abbreviations, such as "Co." and "Inc."</li> <li>• Caller ID supports names of up to 15 letters. If the caller's name has more than 15 letters, the name will not be announced correctly.</li> </ul>
<p>The handset display exits the Caller List or phone book.</p>	<ul style="list-style-type: none"> <li>• Do not pause for over 60 seconds while searching.</li> </ul>
<p>The Ringer/Message Alert indicator flashes slowly when the handset is not ringing or in use.</p>	<ul style="list-style-type: none"> <li>• The Message Alert is turned on and new messages have been recorded. Turn the Message Alert off (p. 28) or listen to the new messages (p. 67, 68, 73).</li> </ul>

## Troubleshooting

Problem	Cause & Remedy
You cannot have a conversation using the headset.	<ul style="list-style-type: none"> <li>• Make sure the optional headset is connected properly (p. 77).</li> <li>• If "SP-phone" is displayed on the handset, press [↶] to switch to the headset.</li> <li>• Please use only the Panasonic KX-TCA88AL headset.</li> </ul>

### Answering System

Problem	Cause & Remedy
The Answering System is on, but incoming messages are not recorded.	<ul style="list-style-type: none"> <li>• The recording time is set to "Greeting only". Select "1 minute", "2 minutes" or "3 minutes" (p. 26).</li> <li>• Memory is full. Erase unnecessary messages (p. 70).</li> </ul>
" <b>FULL</b> " flashes and the ANSWER ON indicator flashes rapidly. No new messages are recorded.	<ul style="list-style-type: none"> <li>• Memory is full. Erase unnecessary messages (p. 70).</li> </ul>
You cannot access a mailbox from the base unit or the handset.	<ul style="list-style-type: none"> <li>• If more than one other user is using the handset and/or base unit, you may not be able to access the mailbox. Try again later.</li> <li>• If another user is listening to messages or the Answering System is handling a call, you cannot access the mailbox. Try again later.</li> </ul>
You cannot access a mailbox from a touch tone phone.	<ul style="list-style-type: none"> <li>• Make sure you entered the correct remote code (p. 74).</li> <li>• If "Enter Mailbox password" is heard, Mailbox 2 or 3 has a password which must be entered (p. 65).</li> <li>• The Answering System may not respond if the tones are too short to activate the unit. Press each button firmly.</li> <li>• The Answering System is off. Turn it on (p. 76).</li> </ul>
When you play back messages or turn on the Answering System, the base unit and handset announce the wrong day and time.	<ul style="list-style-type: none"> <li>• The date and time may be set incorrectly. Set the date and time again (p. 17).</li> </ul>

Useful Information

## Troubleshooting

Problem	Cause & Remedy																												
<p>Caller ID information is not displayed during message playback (p. 69).</p>	<ul style="list-style-type: none"> <li>• Caller ID information will not be displayed                             <ul style="list-style-type: none"> <li>— if a message is recorded by using <b>[MEMO]</b> (p. 71), or</li> <li>— if a call is transferred to a mailbox and the caller leaves a message (p. 72).</li> </ul> </li> </ul>																												
<p>You cannot remember your mailbox password. You cannot retrieve the messages from your mailbox.</p>	<ul style="list-style-type: none"> <li>• Confirm the mailbox password using the handset (p. 65).</li> <li>• If you cannot use the handset, you can retrieve the messages from your mailbox after erasing the password, using the base unit; Press <b>[PROGRAM]</b>, <b>[MUTE]</b>, <b>[#]</b>, and <b>[9][0][0][0]</b>. Please note that the following settings will return to the factory preset with the Mailbox 2 and 3 passwords.</li> </ul> <table border="1" data-bbox="740 954 1235 1473"> <thead> <tr> <th>Function</th> <th>Factory preset</th> </tr> </thead> <tbody> <tr> <td>Date &amp; time</td> <td>—</td> </tr> <tr> <td>Recall time</td> <td>100ms</td> </tr> <tr> <td>Line mode</td> <td>B mode</td> </tr> <tr> <td>Answering System</td> <td>On</td> </tr> <tr> <td>Number of rings</td> <td>4</td> </tr> <tr> <td>Recording time</td> <td>3 min</td> </tr> <tr> <td>Remote code</td> <td>11</td> </tr> <tr> <td>Recording mode</td> <td>Standard (16 min)</td> </tr> <tr> <td>Base unit ringer volume</td> <td>High</td> </tr> <tr> <td>Base unit ringer tone</td> <td>Tone 1</td> </tr> <tr> <td>Base unit incoming call tone</td> <td>2</td> </tr> <tr> <td>Base unit room monitor mode</td> <td>Off</td> </tr> <tr> <td>Base unit Talking Caller ID</td> <td>On</td> </tr> </tbody> </table> <ul style="list-style-type: none"> <li>• You cannot reset the above settings to the factory preset, if the dial lock is turned on (p. 62). If you forget your password of dial lock, consult your nearest Panasonic service centre.</li> </ul>	Function	Factory preset	Date & time	—	Recall time	100ms	Line mode	B mode	Answering System	On	Number of rings	4	Recording time	3 min	Remote code	11	Recording mode	Standard (16 min)	Base unit ringer volume	High	Base unit ringer tone	Tone 1	Base unit incoming call tone	2	Base unit room monitor mode	Off	Base unit Talking Caller ID	On
Function	Factory preset																												
Date & time	—																												
Recall time	100ms																												
Line mode	B mode																												
Answering System	On																												
Number of rings	4																												
Recording time	3 min																												
Remote code	11																												
Recording mode	Standard (16 min)																												
Base unit ringer volume	High																												
Base unit ringer tone	Tone 1																												
Base unit incoming call tone	2																												
Base unit room monitor mode	Off																												
Base unit Talking Caller ID	On																												

## Troubleshooting

### General

Problem	Cause & Remedy
The handset and/or base unit does not work.	<ul style="list-style-type: none"> <li>• Check the settings (p. 12–14).</li> <li>• Fully charge the battery (p. 13).</li> <li>• Clean the charge contacts and charge again (p. 14).</li> <li>• Check battery installation (p. 13).</li> <li>• Unplug the base unit's AC adaptor to reset it. Plug in, and try again.</li> <li>• The handset has not been registered to the base unit. Register the handset (p. 84, steps 5 and 6).</li> <li>• Re-install the battery (p. 13) and fully charge it.</li> <li>• KX-TG5240AL is not designed to be used with rotary (pulse dialling) services.</li> </ul>
"Ⓣ" flashes on the base unit display.	<ul style="list-style-type: none"> <li>• If a power failure occurs, the date and time setting may be erased. Set the date and time again (p. 17).</li> </ul>
"Recharge battery" is displayed, "▢" flashes, or the handset beeps intermittently.	<ul style="list-style-type: none"> <li>• Fully charge the battery (p. 13).</li> </ul>
"Charge for 6 HRS" and "▢" are displayed and the handset does not work.	<ul style="list-style-type: none"> <li>• The battery has been discharged. Fully charge the battery (p. 14).</li> </ul>
You charged the battery fully, but "Recharge battery" is still displayed and/or "▢" continues to flash, or "Charge for 6 HRS" and "▢" are displayed.	<ul style="list-style-type: none"> <li>• Clean the charge contacts and charge again (p. 14).</li> <li>• The battery may need to be replaced. If you install a new battery, fully charge it (p. 13, 14).</li> </ul>
The CHARGE indicator does not go out after the battery has been charged.	<ul style="list-style-type: none"> <li>• This is normal.</li> </ul>

Panasonic Australia operates a toll free Customer Support Centre. Please phone Panasonic on 132600 for assistance.

Useful Information

## Safety Instructions

---

Take special care to follow the safety suggestions listed below.

### Safety

- 1) The unit should be connected to a power supply only of the type described in the operating instructions or as marked on the unit.
- 2) When left unused for a long period of time, the base unit should be unplugged from the household AC outlet.
- 3) To minimize the possibility of lightning damage when you know that a thunderstorm is coming, we recommend that you:
  - a) Unplug the telephone line cord from the phone jack.
  - b) Unplug the power supply cord from the AC power outlet.

### Installations

#### Environment

- 1) Do not use this unit near liquids — for example, near a bathtub, washbowl, sink, etc. Damp environments should also be avoided.
- 2) The unit should be kept away from heat sources such as heaters, kitchen stoves, etc. It also should not be placed in rooms where the temperature is less than 5°C or greater than 40°C.
- 3) The AC adaptor is used as the main disconnect device, ensure that the AC outlet is located/installed near the unit and is easily accessible.

#### Placement

- 1) Do not place heavy objects on top of this unit.
- 2) Care should be taken so that objects do not fall onto, and liquids are not spilled into, the unit. Do not subject this unit to excessive smoke, dust, mechanical vibration or shock.
- 3) Place the unit on a flat surface.

#### For best performance

- 1) If noise prevents the conversation from being understood at the handset, approach the base unit to lessen the noise.
- 2) The handset should be used at the HIGH volume setting when the reception audio is difficult to hear.
- 3) The handset should be fully recharged on the base unit when “Recharge battery” is displayed and/or “” flashes.
- 4) The handset antenna should not be touched during use because it can effect the handset's performance.
- 5) The maximum calling distance may be shortened when the unit is used in the following places: Near obstacles such as hills, tunnels, undergrounds, near metal objects such as wire fences, etc.

#### Medical

Consult the manufacturer of any personal medical devices, such as pacemakers or hearing aids, to determine if they are adequately shielded from external RF (radio frequency) energy. (The unit operates in the frequency range of 5760 MHz to 5840 MHz, and the power output level can range from 0.25 watts to 0.5 watts.) Do not use the unit in health care facilities if any regulations posted in the area instruct you not to do so. Hospitals or health care facilities may be using equipment that could be sensitive to external RF (radio frequency) energy.

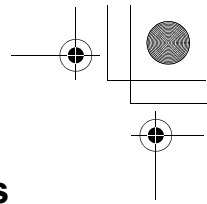
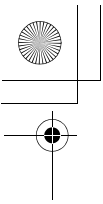

## Safety Instructions

Operating near 5.8 GHz electrical appliances may cause interference.  
Move away from the electrical appliances.

### **WARNING:**

**TO PREVENT FIRE OR SHOCK HAZARD, DO NOT EXPOSE THIS PRODUCT TO LIQUID OR ANY TYPE OF MOISTURE.**

If there is any trouble, disconnect the unit from the telephone line and connect a known working phone. If the known working phone operates properly, do not reconnect the unit to the telephone line until the fault has been repaired. If the known working phone does not operate properly, consult your telephone company.

This equipment has been tested and found to comply with AS/NZS 3548:1995 limits for electromagnetic interference. Any modifications to any part of the system or to any peripherals may void the EMC compliance of the system or the peripherals.

This equipment will be inoperable if mains power fails.

The earcap on the handset is magnetised and may retain metallic objects.

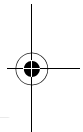
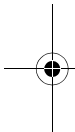
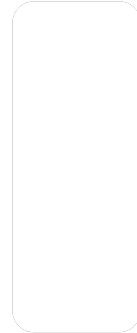

Useful Information

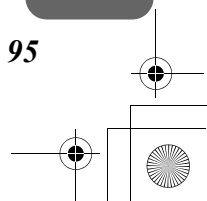
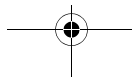
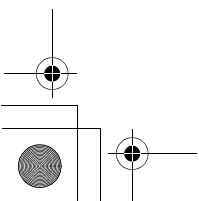

# Important Information

## Instructions to customer

### Installation

Attached to this apparatus is an approval label. This label is evidence that it is a "Permitted Attachment" which has been authorised to be connected to your telephone service.

Conditions relating to connection and operation of this Permitted Attachment are contained in Telecommunications General By-Law 220 (5).

You are authorised to install this Permitted Attachment yourself by plugging it into the line socket of any regular telephone. You may connect it in place of your existing telephone or to any spare telephone socket installed in your premises.

To disconnect your existing telephone you must first remove its plug from the line socket. You can then insert the plug of your Permitted Attachment into the socket and use your equipment.

If the plug of your existing telephone cannot be readily removed, you will have to remove the screw securing it. To do this proceed as follows:

1. Loosen screw "A" sufficiently to remove the socket cover. (See Fig. 1.)
2. Remove screw "B" and withdraw the plug. (See Fig. 2.)
3. Replace screw "B". (See Fig. 3.) Ensure that it screws completely into the socket recess. (If the screw is too long, increase the hole depth or replace the screw with one 5 mm shorter.)
4. Replace socket cover and tighten screw "A". (See Fig. 4.)

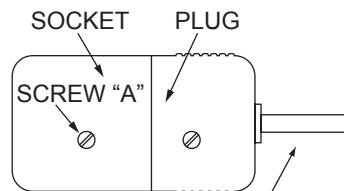

Fig. 1

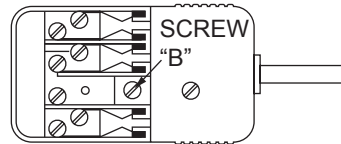

Fig. 2

TELEPHONE CORD  
(Connect to the PLUG  
as shown in Fig. 1.)



Fig. 3

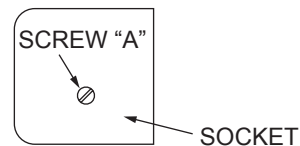

Fig. 4



## Important Information

If you are satisfied with the operation of your telephone service after plugging in your Permitted Attachment, your installation is completed.

You will be unable to connect this Permitted Attachment if your telephone service consists only of a wall phone or an old style telephone which is not connected by means of a modern plug and socket. In such cases a new socket will need to be installed.

Should the Permitted Attachment not operate when plugged into a socket, it is either faulty or unsuitable for operation with your telephone service. It should be returned to the store where purchased or an Authorised Service Centre.

### Service difficulties

If at any time a fault occurs on your telephone service, carry out the following checks before you call for service:

- Disconnect the Permitted Attachment and try using the service with the normal telephone.
- If the telephone service then operates satisfactorily, the fault is in your Permitted Attachment. Leave the Permitted Attachment disconnected and report the fault to its supplier or agent to arrange for repair.
- If when using the telephone the service is still faulty, report the fault to "Service Difficulties and Faults" for attention.

You are required to keep this Permitted Attachment in good working order while it is connected to your telephone service. Its construction or internal circuit must not be modified in any way without permission.

### WARNING

This cordless telephone system does not incorporate provision for secrecy of conversations. Appropriately tuned radio equipment and other cordless telephone systems in close proximity may be used by a third party to monitor and possibly interrupt conversations in progress when this system is on radio operation.

## Specifications

---

### ■ Handset

<b>Power Supply:</b>	Ni-MH battery (3.6 V, 830 mAh)
<b>Frequency:</b>	5.76 GHz – 5.84 GHz
<b>Dimensions (H x W x D):</b>	Approx. 220 mm x 53 mm x 37 mm
<b>Mass (Weight):</b>	Approx. 210 g
<b>Security Codes:</b>	1,000,000

### ■ Base Unit

<b>Power Supply:</b>	AC adaptor (230 – 240 V AC, 50 Hz)
<b>Power Consumption:</b>	Standby: Approx. 2.5 W Maximum: Approx. 6.0 W
<b>Frequency:</b>	5.76 GHz – 5.84 GHz
<b>Dimensions (H x W x D):</b>	Approx. 107 mm x 251 mm x 135 mm
<b>Mass (Weight):</b>	Approx. 480 g

### ■ Operating Environment: 5 °C – 40 °C

Specifications are subject to change without notice.

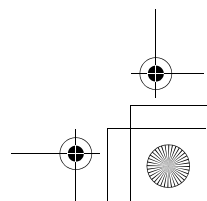
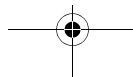
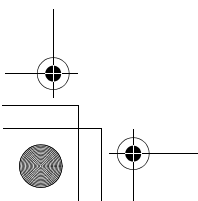
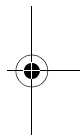
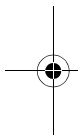
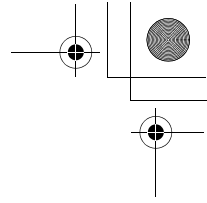
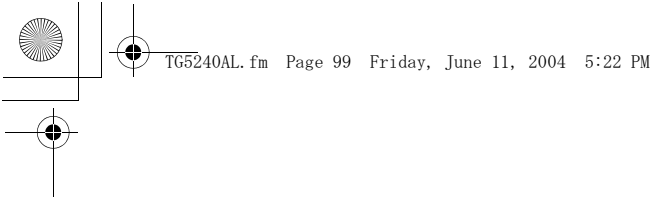

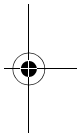
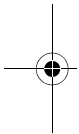
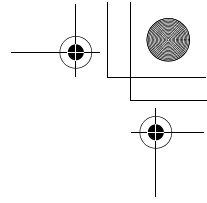
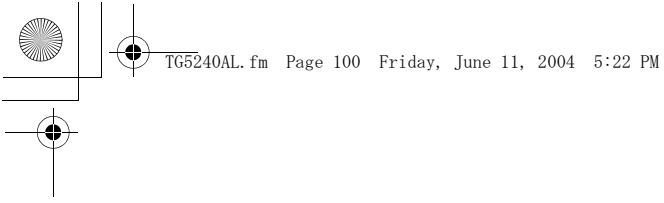

# N52

**Sales Department:**

**Panasonic Australia Pty. Limited**

Austlink Corporate Park, 1 Garigal Road, Belrose NSW 2085, Australia

**Manufacturer:**

**Panasonic Communications Co., Ltd.**

1-62, 4-chome, Minoshima, Hakata-ku, Fukuoka 812-8531, Japan

© 2004 Panasonic Communications Co., Ltd. All Rights Reserved.

**PQQX14275YA** S0504-1064

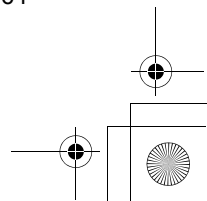
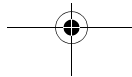
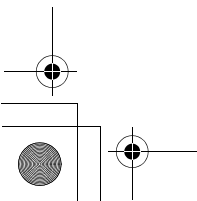

## Free Manuals Download Website

<http://myh66.com>

<http://usermanuals.us>

<http://www.somanuals.com>

<http://www.4manuals.cc>

<http://www.manual-lib.com>

<http://www.404manual.com>

<http://www.luxmanual.com>

<http://aubethermostatmanual.com>

Golf course search by state

<http://golfingnear.com>

Email search by domain

<http://emailbydomain.com>

Auto manuals search

<http://auto.somanuals.com>

TV manuals search

<http://tv.somanuals.com>