

Panasonic®

Operating Instructions

5.8 GHz Expandable Digital Cordless
Answering System

Model No. **KX-TG6700**

5.8 GHz Expandable Digital Cordless
Answering System with Two Handsets

Model No. **KX-TG6702**

2LINE

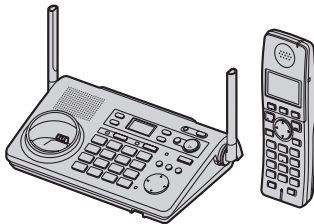

Model shown is KX-TG6700.

This unit is compatible with Caller ID. To use this feature, you must subscribe to the appropriate service offered by your telephone service provider.

Charge the handset battery for 7 hours before initial use.

Please read these Operating Instructions before using the unit and save for future reference.

For assistance, visit our website:

<http://www.panasonic.com/phonehelp> for customers in the U.S.A. or Puerto Rico.

Table of Contents

Introduction

Introduction	3
Accessory information	4
Important safety instructions	6
For best performance	8

Preparation

Setting up the base unit	9
Setting up the handset	12
Controls	15
Displays	17
Symbols used in these operating instructions	18
Setting the unit before use	19

Making/Answering Calls

Making calls	21
Answering calls	23
Useful features during a call	24
Using the other line during a call	27

Phonebook

Handset phonebook	28
-----------------------------	----

Base Unit Speed Dialer

Base unit speed dialer	31
----------------------------------	----

Caller ID Service

Using Caller ID service	32
Caller list	33

Programming

Programmable settings	35
---------------------------------	----

Answering System

Answering system	40
Listening to messages using the base unit	42
Listening to messages using the handset	43
Voice memo	44

Remote operation	45
Answering system settings	47

Multi-unit Operation

Intercom	49
Transferring calls	50
Conference calls	51
Room monitor	53
Registering a handset	54

Useful Information

Additional accessories	55
Error messages	56
Troubleshooting	58
FCC and other information	62
Specifications	65
Customer services	66
Warranty	67

Index

Index	69
-----------------	----

Introduction

Thank you for purchasing a Panasonic cordless telephone.

We recommend keeping a record of the following information for future reference.

Serial No. (found on the bottom of the base unit)	Date of purchase
Name and address of dealer	

Attach your purchase receipt here.

Notable differences between KX-TG6700 and KX-TG6702

These operating instructions can be used for the following models:

KX-TG6700 features a handset.

KX-TG6702 features 2 handsets.

Important:

- References in these operating instructions to “a charger” or “other handsets” are for accessory handset users and KX-TG6702 users only. See “Expanding your phone system” on page 5.

KX-TG6700

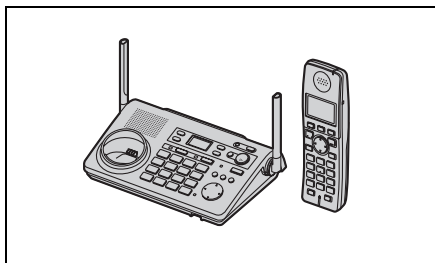

KX-TG6702

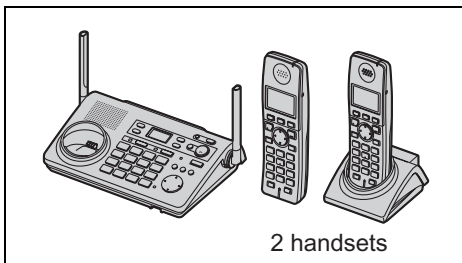

Accessory information

Included accessories

No.	Accessory item	Order number	Quantity	
			KX-TG6700	KX-TG6702
①	AC adaptor	PQLV207Z	1	2
②	4-wire telephone line cord with green plugs	PQJA10088Z	1	1
③	2-wire telephone line cord with transparent plugs	PQJA10075Z	1	1
④	Battery	HHR-P105	1	2
⑤	Handset cover ^{*1}	PQYNTG6700BR	1	2
⑥	Charger	PQLV30043ZB	–	1

①

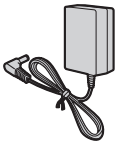

②



③



④

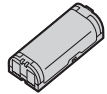

⑤

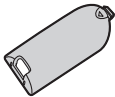

⑥

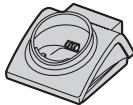

*1 The handset cover comes attached to the handset.

Additional/replacement accessories

Accessory item	Order number
Rechargeable nickel metal hydride (Ni-MH) battery	HHR-P105
Headset	KX-TCA60, KX-TCA86, KX-TCA88HA, KX-TCA91, KX-TCA92, KX-TCA93, KX-TCA94, KX-TCA95, or KX-TCA98
Belt clip	PQKE10457Z2
Wall-mounting adaptor for base unit	PQKL10078Z2
T-adaptor	KX-J66
2-line splitter	KX-J42

Note:

- You can expand your phone system by registering additional compatible Panasonic units (page 5).

Sales and support information

- To order additional/replacement accessories, call 1-800-332-5368.
- TTY users (hearing or speech impaired users) can call 1-866-605-1277.

Expanding your phone system

You can expand the phone system by registering the accessory handsets to a single base unit.

Handset (optional): KX-TGA670

5.8 GHz expandable digital cordless handset:

Max. 8 (including handset(s) sold with KX-TG6700 or KX-TG6702 base unit)

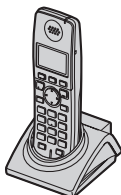

Important safety instructions

When using the product, basic safety precautions should always be followed to reduce the risk of fire, electric shock, or personal injury.

1. Read all instructions carefully.
2. Follow all warnings and instructions marked on the product.
3. Unplug the product from power outlets before cleaning. Do not use liquid or aerosol cleaners. Use a moist cloth for cleaning.
4. Do not use the product near water, for example near a bathtub, wash bowl, kitchen sink, etc.
5. Place the product securely on a stable surface. Serious damage and/or injury may result if the product falls.
6. Do not cover slots and openings on the product. They are provided for ventilation and protection against overheating. Never place the product near radiators, or in a place where proper ventilation is not provided.
7. Use only the power source marked on the product. If you are not sure of the type of power supplied to your home, consult your dealer or local power company.
8. Do not place objects on the power cord. Install the product where no one can step or trip on the cord.
9. Do not overload power outlets and extension cords. This can result in the risk of fire or electric shock.
10. Never push any objects through slots in the product. This may result in the

risk of fire or electric shock. Never spill any liquid on the product.

11. To reduce the risk of electric shock, do not disassemble the product. Take the product to an authorized service center when service is required. Opening or removing covers may expose you to dangerous voltages or other risks. Incorrect reassembly can cause electric shock when the product is subsequently used.
12. Unplug the product from power outlets and take to an authorized service center when the following conditions occur:
 - A. When the power cord is damaged or frayed.
 - B. If liquid has been spilled into the product.
 - C. If the product has been exposed to rain or water.
 - D. If the product does not work normally by following the operating instructions. Adjust only controls covered by the operating instructions. Improper adjustment may require extensive work by an authorized service center.
 - E. If the product has been dropped or physically damaged.
 - F. If the product exhibits a distinct change in performance.
13. During thunderstorms, avoid using telephones except cordless types. There may be a remote risk of an electric shock from lightning.
14. Do not use the product to report a gas leak, when in the vicinity of the leak.

SAVE THESE INSTRUCTIONS

CAUTION:

Installation

- Never install telephone wiring during a lightning storm.
- Never install telephone jacks in wet locations unless the jack is specifically designed for wet locations.
- Never touch uninsulated telephone wires or terminals unless the telephone line has been disconnected at the network interface.
- Use caution when installing or modifying telephone lines.
- Do not touch the plug with wet hands.
- The AC adaptor is used as the main disconnect device. Ensure that the AC outlet is installed near the product and is easily accessible.

Battery

To reduce the risk of fire or injury to persons, read and follow these instructions.

- Use only the battery(ies) specified.
- Do not dispose of the battery(ies) in a fire. They may explode. Check with local waste management codes for special disposal instructions.
- Do not open or mutilate the battery(ies). Released electrolyte is corrosive and may cause burns or injury to the eyes or skin. The electrolyte may be toxic if swallowed.
- Exercise care when handling the battery(ies). Do not allow conductive materials such as rings, bracelets or keys to touch the battery(ies), otherwise a short circuit may cause the battery(ies) and/or the conductive material to overheat and cause burns.

- Charge the battery(ies) provided, or identified for use with the product only, in accordance with the instructions and limitations specified in this manual.

WARNING:

- To prevent the risk of fire or electrical shock, do not expose the product to rain or any type of moisture.
- Unplug the product from power outlets if it emits smoke, an abnormal smell, or makes an unusual noise. These conditions can cause fire or electric shock. Confirm that smoke has stopped emitting and contact the Panasonic Call Center at 1-800-211-PANA (1-800-211-7262).

Medical

- Consult the manufacturer of any personal medical devices, such as pacemakers or hearing aids, to determine if they are adequately shielded from external RF (radio frequency) energy. (The product operates in the frequency range of 5.76 GHz to 5.84 GHz, and the power output is 200 mW (max.)) Do not use the product in health care facilities if any regulations posted in the area instruct you not to do so. Hospitals or health care facilities may be using equipment that could be sensitive to external RF energy.

For best performance

Base unit location/avoiding noise

The base unit and other compatible Panasonic units use radio waves to communicate with each other.

For maximum distance and noise-free operation, we recommend the following:

- Placing the product away from electrical appliances.
- Placing the base unit in a HIGH and CENTRAL location with no obstructions such as walls.
- Raising the antennas vertically.
- If you use the handset near a microwave oven which is being used, noise may be heard. Move away from the microwave oven and closer to the base unit.
- If you use the handset near another cordless phone's base unit, noise may be heard. Move away from the other cordless phone's base unit and closer to your base unit.

Environment

- Keep the product away from electrical noise generating devices, such as fluorescent lamps and motors.
- The product should be kept free from excessive smoke, dust, high temperature, and vibration.
- The product should not be exposed to direct sunlight.
- Do not place heavy objects on top of the product.
- When you leave the product unused for a long period of time, unplug the product from the power outlet.

- The product should be kept away from heat sources such as heaters, kitchen stoves, etc. It should not be placed in rooms where the temperature is less than 5 °C (41 °F) or greater than 40 °C (104 °F). Damp basements should also be avoided.
- The maximum calling distance may be shortened when the product is used in the following places: Near obstacles such as hills, tunnels, underground, near metal objects such as wire fences, etc.
- Operating the product near 5.8 GHz electrical appliances may cause interference. Move away from the electrical appliances.

Routine care

- Wipe the outer surface of the product with a soft moist cloth. Do not use benzine, thinner, or any abrasive powder.

Setting up the base unit

Overview

- 1 Connect the AC adaptor.
- 2 Connect the telephone line cord.
 - To connect to a 2-line telephone jack: page 10
 - To connect to 2 single-line telephone jacks: page 10
 - To connect to a single-line telephone jack: page 10For DSL service subscribers:
 - To connect to a 2-line telephone jack: page 11
 - To connect to 2 single-line telephone jacks: page 11

Connecting the AC adaptor

Connect the AC adaptor, then raise the antennas.

- Use only the included Panasonic AC adaptor PQLV207.

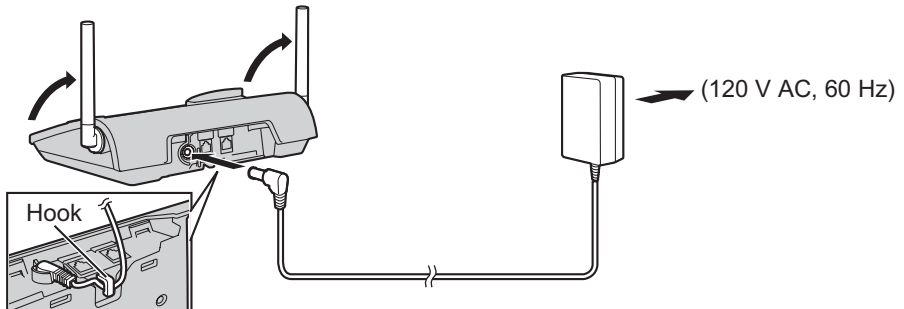

Note:

- The AC adaptor must remain connected at all times. (It is normal for the adaptor to feel warm during use.)
- The AC adaptor should be connected to a vertically oriented or floor-mounted AC outlet. Do not connect the AC adaptor to a ceiling-mounted AC outlet, as the weight of the adaptor may cause it to become disconnected.
- The unit will not work during a power failure. We recommend connecting a corded telephone to the same telephone line or to the same telephone jack using a Panasonic T-adaptor (page 5).

Preparation

Connecting the telephone line cord

Connect the telephone line cord until it clicks into the telephone jack.

To connect to a 2-line telephone jack

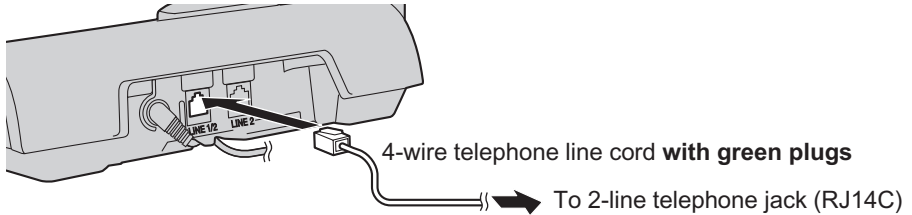

To connect to 2 single-line telephone jacks

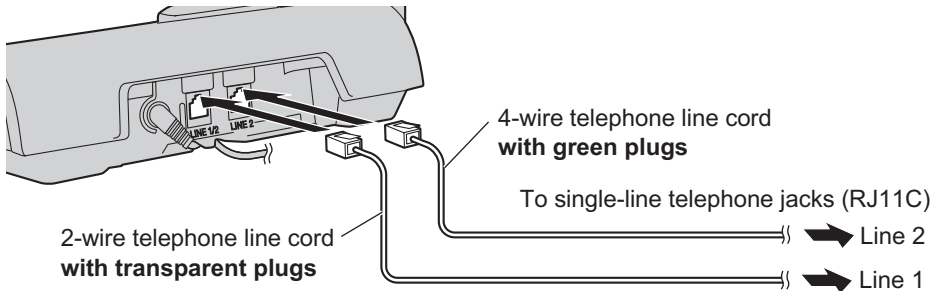

To connect to a single-line telephone jack

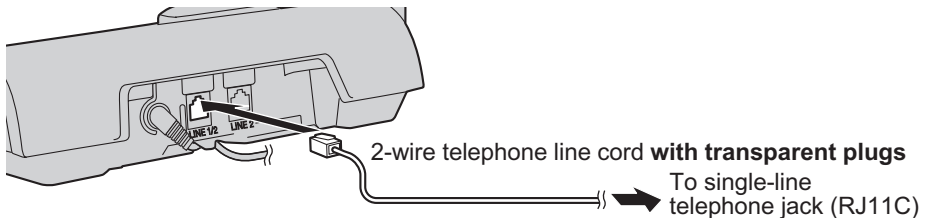

Note:

- Make sure you connect the telephone line cord into LINE1/2 telephone jack.
-

If you subscribe to a DSL service

Please attach a noise filter (contact your DSL provider) to the telephone line between the base unit and the telephone line jack in the event of the following:

- Noise is heard during conversations.
- Caller ID features (page 32) do not function properly.

To connect to a 2-line telephone jack

For this connection, please purchase a Panasonic 2-line splitter (page 5).

Example: DSL line is line 2

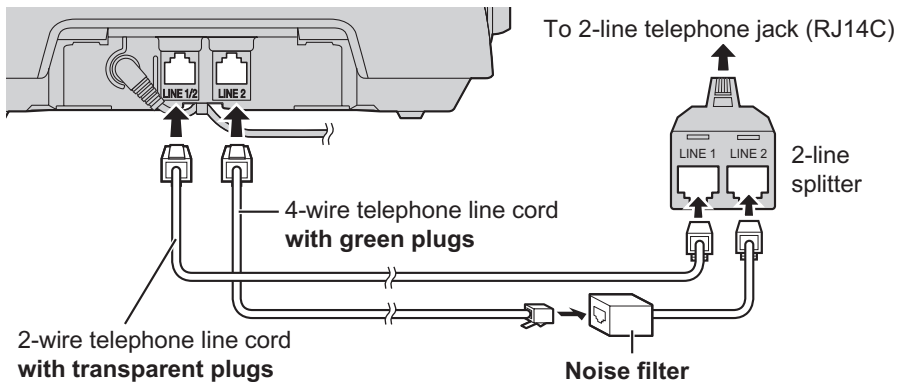

To connect to 2 single-line telephone jacks

Example: DSL line is line 2

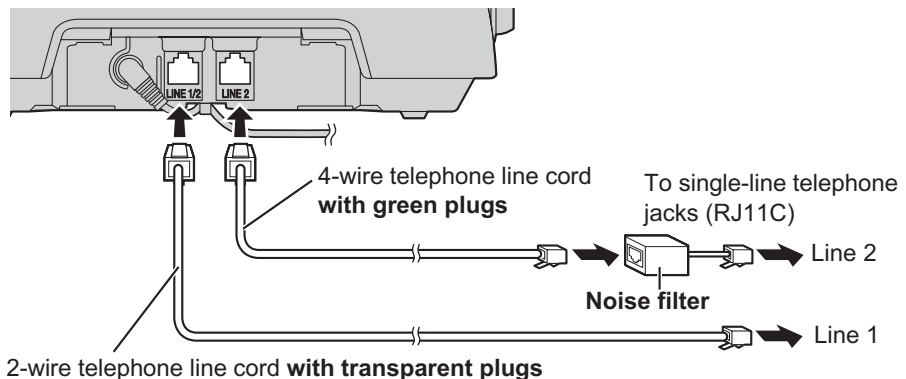

Setting up the handset

Connecting the charger (KX-TG6702 only)

- Use only the included Panasonic AC adaptor PQLV207.

(120 V AC, 60 Hz)

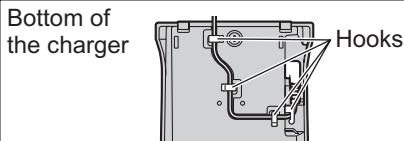
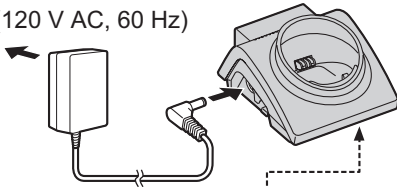

Fasten the AC adaptor cord to prevent it from being disconnected.

Note:

- The AC adaptor must remain connected at all times. (It is normal for the adaptor to feel warm during use.)
- The AC adaptor should be connected to a vertically oriented or floor-mounted AC outlet. Do not connect the AC adaptor to a ceiling-mounted AC outlet, as the weight of the adaptor may cause it to become disconnected.

Battery installation/replacement

- 1 Press the notch of the handset cover firmly, and slide it in the direction of the arrow.
 - If necessary, remove the old battery.

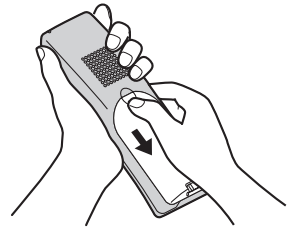

- 2 Insert the battery (1), and press it down until it snaps into position (2). Then close the handset cover (3, 4).

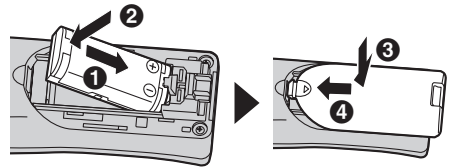

Important:

- Use only the rechargeable Panasonic battery noted on page 5.

Attention:



A nickel metal hydride battery that is recyclable powers the product you have purchased.

Please call 1-800-8-BATTERY (1-800-822-8837) for information on how to recycle this battery.

Battery charge

Place the handset on the base unit or charger for **7 hours** before initial use. While charging, the charge indicator on the handset lights in amber. When the battery is fully charged, "Charge completed" is displayed.

Base unit

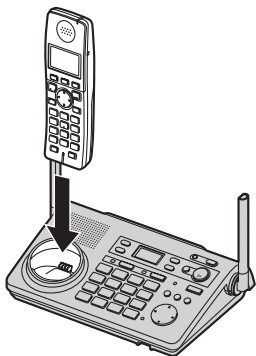

Charger (KX-TG6702 only)

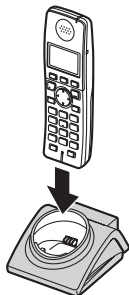

Note:

- If you want to use the handset immediately, charge the battery for at least 15 minutes.
- To ensure that the battery charges properly, clean the charge contacts of the handset, base unit, and charger with a soft, dry cloth once a month. Clean more often if the unit is subject to the exposure of grease, dust, or high humidity.

Battery level

Battery icon	Battery level
	Fully charged
	Medium
	Low Flashing: needs to be recharged.
	Empty

Note:

- When the battery needs to be charged, the handset beeps intermittently during use.

Preparation

Panasonic battery performance

Operation	Operating time
While in use (talking)	Up to 5 hours
While not in use (standby)	Up to 7 days
While using the clarity booster feature (page 25)	Up to 3 hours

Note:

- Battery operating time may be shortened over time depending on usage conditions and surrounding temperature.
- Battery power is consumed whenever the handset is off the base unit or charger, even when the handset is not in use. Hence the longer you leave the handset off the base unit or charger, the less time you may actually talk using the handset.
- After the handset is fully charged, displaying "Charge completed", it may be left on the base unit or charger without any ill effect on the battery.
- The battery level may not be displayed correctly after you replace the battery. In this case, place the handset on the base unit or charger and let charge for 7 hours.

Wall mounting for charger (KX-TG6702 only)

- 1 Drive the screws (not included) into the wall using the wall mount template as a guide.

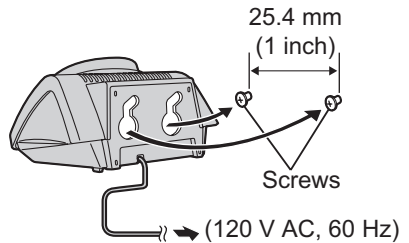

- 2 Mount the charger (1), then slide it down (2) and to the right (3) until it is secure.

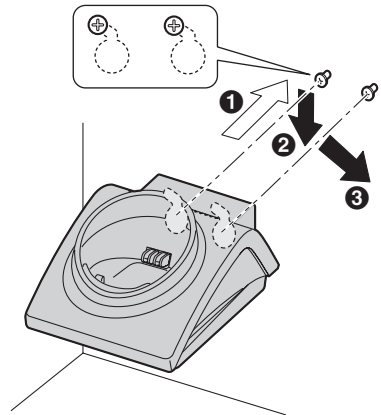

Wall mount template for the charger

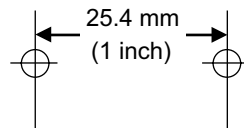

Controls

Base unit

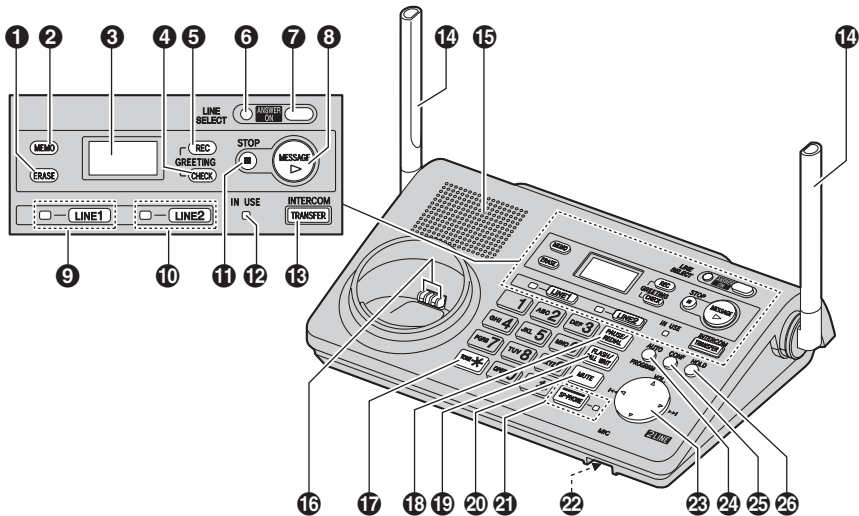

- | | |
|--------------------------------------|---|
| 1 [ERASE] | 14 Antenna |
| 2 [MEMO] | 15 Speaker |
| 3 Display | 16 Charge contacts |
| 4 [GREETING CHECK] | 17 [*] (TONE) |
| 5 [GREETING REC] (Recording) | 18 [PAUSE] [REDIAL] |
| 6 [LINE SELECT] | 19 [FLASH] [CALL WAIT] |
| 7 [ANSWER ON] | 20 [MUTE] |
| 8 [MESSAGE] | 21 [SP-PHONE] (Speakerphone)
SP-PHONE indicator |
| 9 [LINE1]
LINE1 indicator | 22 MIC (Microphone) |
| 10 [LINE2]
LINE2 indicator | 23 Navigator key ([▲] [▼] [◀◀] [▶▶]) |
| 11 [STOP] | 24 [AUTO] [PROGRAM] |
| 12 IN USE indicator | 25 [CONF] (Conference) |
| 13 [TRANSFER] [INTERCOM] | 26 [HOLD] |

Preparation

Handset

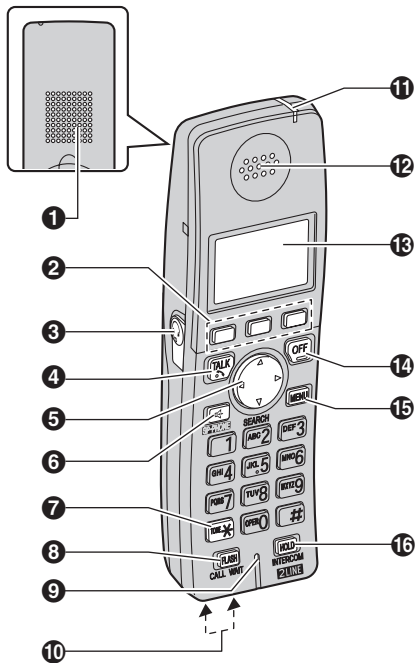

- 1 Speaker
- 2 Soft keys
- 3 Headset jack
- 4 [TALK]
- 5 Navigator key ([UP] [DOWN] [LEFT] [RIGHT])/
SEARCH ([UP] [DOWN])
- 6 [SP-PHONE]
- 7 [TONE]
- 8 [FLASH] [CALL WAIT]
- 9 Microphone
- 10 Charge contacts
- 11 Charge indicator
Ringer indicator
Message indicator

- 12 Receiver
- 13 Display
- 14 [OFF]
- 15 [MENU]
- 16 [HOLD] [INTERCOM]

Using the navigator key

The handset navigator key can be used to navigate through menus and to select items shown on the display, by pressing [UP], [DOWN], [LEFT], or [RIGHT].

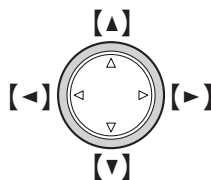





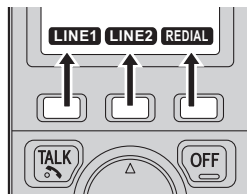



Handset soft keys

The handset features 3 soft keys. By pressing a soft key, you can select the function displayed directly above it.





Displays



Base unit display items

Displayed item	Meaning
	Flashes when the date and time need to be set.
LINE 1 LINE 2	Indicates the selected line(s) for the answering system or ringer setting. Flashing: the answering system is answering a call or playing a message on the line.
FULL	Flashes when message memory is full.
L1 	Indicates the line 1 ringer on the base unit is off.
L2 	Indicates the line 2 ringer on the base unit is off.
	Greeting or memo message recording error
	Answering system is in greeting only mode (caller message cannot be recorded). It is displayed when you turn the answering system on.
Example: 	Handset number: displayed when the base unit is on intercom call, monitoring, or monitored by a handset.
	Paging all handsets
	Base unit is in programming mode.

Handset display items

Displayed item	Meaning
VE	Voice enhancer is on.
	Battery level
L1 L2	The line is in use. Flashing: – the call is put on hold on that line. – the answering system is answering a call on that line. Flashing rapidly: a call is being received on that line.
SP	Speaker is on.
PRIV.	Call privacy mode is on.
Example: 	Handset's extension number.

Symbols used in these operating instructions

Symbol	Meaning
[] : button name/soft key name Example: Unit keys: [] , [OFF] Soft keys: [CID] , [	The words in the brackets indicate button names/soft key names on the handset and base unit.
→	Proceed to the next operation.
Example: "Ringer tone"	The words in quotations indicate the menu on the display.
Example: 1 [MENU] → [0][2] 2 Select the desired setting. 3 [SAVE] → [OFF]	1 Press [MENU] , then press [0] , [2] . 2 Press [▲] or [▼] to select the desired setting. 3 Press [SAVE] , then press [OFF] .
Handset: [▲] [▼] [◀] [▶]	Press up, down, left, or right on the handset navigator key.
Base unit: [▲] [▼] [◀◀] [▶▶]	Press up, down, left, or right on the base unit navigator key.

Setting the unit before use

Important:

- To program features by scrolling through the display menus, see page 35.

Display language

The default setting is “English”.

Handset

1 [MENU] → [0][8]

2 Select the desired setting.

3 Press the middle soft key to save. → [OFF]

Dialing mode

If you cannot make calls, change this setting according to your telephone line service. The default setting is “Tone”.

“Tone”: For tone dial service.

“Pulse”: For rotary pulse dial service.

Handset

1 [MENU] → [0][5][1]

2 Select the desired setting. → [SAVE] → [OFF]

Date and time

Set the correct date and time. When you play back a message from the answering system (page 42), the unit announces the day and time it was recorded.

Handset

1 [MENU] → [4]

2 Enter the current month, day, and year by selecting 2 digits for each.

Example: August 15, 2006

[0][8] [1][5] [0][6]

3 Enter the current hour and minute (12-hour clock format) by selecting 2 digits for each.

Example: 9:30

[0][9] [3][0]

4 Press [AM/PM] to select “AM” or “PM”. → [SAVE] → [OFF]

Note:

- If you make a mistake when entering the date and time, press [←], [→], [▲], or [▼] to move the cursor, then make the correction.

Preparation

Line selection

The line selection mode determines which line is selected when you press **[↶]** on the handset or **[SP-PHONE]** on the base unit. The default setting is “**Auto**”.

- “**Auto**”: When making a call, line 1 is selected. If that line is unavailable, line 2 is selected. When answering a call, the ringing line is selected.
- “**Line1**”: Line 1 is selected.
- “**Line2**”: Line 2 is selected.

Handset line selection

Handset

1 **[MENU]** → **[0][5][5]**

2 Select the desired setting. → **[SAVE]**
→ **[OFF]**

Note:

- You can select a line manually regardless of the line selection mode by pressing **[LINE1]** or **[LINE2]**.

Base unit line selection

Handset

1 **[MENU]** → **[0][*][5]**

2 Select the desired setting. → **[SAVE]**
→ **[OFF]**

Note:

- You can select a line manually regardless of the line selection mode by pressing **[LINE1]** or **[LINE2]**.

Making calls

While one line is in use, you can make or answer a call using the other line.

Using the handset

- 1 Lift the handset and dial the phone number.
 - To correct a digit, press **[CLEAR]**.
- 2 Press **[↶]**.
 - An available line is automatically selected and the line number is displayed.
- 3 When you finish talking, press **[OFF]** or place the handset on the base unit or charger.

Note:

- The IN USE indicator on the base unit lights while using the handset.
- You can also select a line by pressing **[LINE1]** or **[LINE2]** in step 2.
- To change the line selection, see page 20.

Using the speakerphone

- 1 Lift the handset, dial the phone number, and press **[☎]**.
 - Speak alternately with the other party.
- 2 When you finish talking, press **[OFF]**.

Note:

- Use the speakerphone in a quiet environment.
- To switch to the receiver, press **[↶]**.

Adjusting the receiver/speaker volume

Press **[▲]** or **[▼]** repeatedly while talking.

Making a call using the redial list

The last 5 phone numbers dialed are stored in the redial list.

- 1 **[REDIAL]**
- 2 Press **[▲]** or **[▼]** to select the desired number.
- 3 **[↶]**

Erasing a number in the redial list

- 1 **[REDIAL]**
- 2 Press **[▲]** or **[▼]** to select the desired number. → **[ERASE]**
- 3 **[YES]** → **[OFF]**

Making/Answering Calls

Using the base unit

1 [SP-PHONE]

- An available line is automatically selected and LINE1 or LINE2 indicator lights.

2 Dial the phone number.

3 When the other party answers, speak into the MIC.

- Speak alternately with the other party.

4 When you finish talking, press [SP-PHONE].

Note:

- You can also select a line by pressing [LINE1] or [LINE2] in step 1.
- Use the speakerphone in a quiet environment.
- While on a call, you can switch from the base unit to the handset:
 - Press [LINE1] or [LINE2] on the handset, then press [SP-PHONE] on the base unit.
 - If the handset is on the base unit, simply lift it.
- To change the line selection, see page 20.

Adjusting the speaker volume

Press [▲] or [▼] repeatedly while talking.

Redialing the last number dialed

[SP-PHONE] → [REDIAL]



Understanding the indicators

The LINE1 and LINE2 indicators show the status of each line as follows.

Status	Meaning
Light off	The line is free.
Light on	The line is in use.
Flashing rapidly	A call is being received.
Flashing	A call is put on hold or the answering system is answering a call.

Answering calls

Using the handset

- 1 Lift the handset and press **[]** or **[]**.
 - The called line is automatically selected.
 - You can also answer the call by pressing any button except navigator key or **[OFF]**. (**Any key talk feature**)

- 2 When you finish talking, press **[OFF]**.

Note:

- You can also answer the call by pressing **[LINE1]** or **[LINE2]** in step 1.
- To change the line selection, see page 20.

Auto talk

This feature allows you to answer a call by simply lifting the handset off the base unit or charger. You do not need to press **[]**. To activate this feature, see page 37.

Temporary ringer off

While the handset is ringing for a call, you can turn the ringer off temporarily by pressing **[OFF]**.

Using the base unit

1 **[SP-PHONE]**

- The called line is automatically selected.

- 2 Speak into the MIC.

- 3 When you finish talking, press **[SP-PHONE]**.

Note:

- You can also answer the call by pressing **[LINE1]** or **[LINE2]** in step 1.
- To change the line selection, see page 20.

Adjusting the ringer volume

- 1 Press **[LINE SELECT]** repeatedly to select the desired line when in standby mode.

- You cannot set the ringer volume for both lines at the same time.

- 2 Press **[▲]** or **[▼]** repeatedly to select the desired volume.

- To turn the ringer off, press and hold **[▼]** until the unit beeps.
- To stop ringing, press **[STOP]**.

Changing the ringer tone

You can change the base unit ringer tone heard when an outside call is received. There are 4 tones and 4 melodies.

- 1** Press **[LINE SELECT]** repeatedly to select the desired line when in standby mode.
 - You cannot set the ringer tone for both lines at the same time.
- 2** Within 10 seconds, press **[◀◀]** or **[▶▶]** repeatedly to select the desired ringer tone.
 - To stop ringing, press **[STOP]**.

Note:

- If you subscribe to a distinctive ring service (such as IDENT-A-RING), select a tone (Tone 1 to 4). If you select a melody, you will not be able to distinguish lines by their ringers.
- If you select one of the melody ringer patterns, the ringer will continue to sound for several seconds if:
 - the caller hangs up before you answer the call.
 - another person answers the call using another phone connected on the same line.

Useful features during a call

HOLD button

This feature allows you to put an outside call on hold.

Handset

- 1** Press **[HOLD]** during an outside call.
 - To transfer the call to the base unit or another handset, continue from step 2, “Transferring calls”, page 50.
- 2** Press **[HOLD]** again.
 - To release the hold, press **[LINE1]** or **[LINE2]** that is flashing on the handset.

Base unit

Press **[HOLD]** during an outside call.

- To release the hold, press **[LINE1]** or **[LINE2]** that is flashing on the base unit.

Note for handset and base unit:

- If another phone is connected to the same line (page 10), you can also take the call by lifting its handset.
- If a call is kept on hold for more than 6 minutes, an alarm tone starts to sound. After 4 additional minutes on hold, the call is disconnected.

MUTE

While mute is turned on, you can hear the other party, but the other party cannot hear you.

Handset

To mute your voice, press **[MUTE]**.

- To return to the conversation, press **[MUTE]** or **[↶]**.

Note:

- **[MUTE]** is a soft key visible on the handset display during a call.

Base unit

To mute your voice, press **[MUTE]**.

- To return to the conversation, press **[MUTE]** or **[SP-PHONE]**.

FLASH button

Pressing **[FLASH]** allows you to use special features of your host PBX such as transferring an extension call, or accessing optional telephone services such as Call Waiting.

Note:

- To change the flash time, see page 39.

For Call Waiting service users

To use Call Waiting, you must subscribe to Call Waiting service of your telephone service provider.

This feature allows you to receive calls while you are already talking on the phone. If you receive a call while on the phone, you will hear a Call Waiting tone. Please contact your telephone service provider for details and availability of this service in your area.

Press **[CALL WAIT]** to answer the 2nd call after the tone.

- To switch between calls, press **[CALL WAIT]**.

Temporary tone dialing (for rotary/pulse service users)

You can temporarily switch the dialing mode to tone when you need to access touch tone services (for example, answering services, telephone banking services, etc.).

Press **[*]** (TONE) before entering access numbers which require tone dialing.

Handset clarity booster

This feature can improve sound clarity when the handset is used in an area where there may be interference. During an outside call, this feature is turned on automatically when necessary. You can also turn this feature on or off manually.

- 1 Press **[MENU]** during an outside call.
- 2 Press **[3]** to select "Booster on" or "Booster off".

Note:

- When this feature is turned off manually during a call, it does not turn on automatically during the same call.
- While this feature is turned on;
 - the battery operating time is shortened (page 14).
 - the maximum number of extensions that can be used at a time may decrease.

Making/Answering Calls

Handset voice enhancer

This feature clarifies the voice of the person you are talking to, reproducing a more natural-sounding voice that is easier to hear and understand.

To turn on or off this feature, press **[(VE)]** during an outside call.

- When this feature is turned on, **VE** is displayed.

Note:

- Depending on the condition and quality of your telephone line, this feature may emphasize existing line noise. If it becomes difficult to hear, turn this feature off.
- While you are using both lines simultaneously, **[(VE)]** is not displayed. Use the following procedure to turn this feature on or off.
Press **[MENU]** during a conversation, then press **[4]** to select “**v.e. on**” or “**v.e. off**”.

Call share

This feature allows the handset and base unit to join an existing outside call.

Handset

To join the conversation, press **[LINE1]** or **[LINE2]** to select the line that is being used by another extension for an outside call.

Base unit

To join the conversation, press **[LINE1]** or **[LINE2]** to select the line that is being used by another extension for an outside call.

Note for handset and base unit:

- A maximum of 4 parties (including 1 or 2 outside parties) can join a conversation.

Call privacy

Call privacy allows you to prevent other users from joining your conversations with outside callers. To allow other users to join your conversations, leave this feature off.

Handset

- 1 Press **[MENU]** during an outside call.
- 2 Press **[2]** to select “**Privacy on**” or “**Privacy off**”.
 - When this feature is turned on, “**PRIV.**” is displayed.

Note:

- This feature will turn off after you hang up the call.

Using the other line during a call

When a call is being received on the other line during a conversation, the interrupt tones sound (page 37). **L1** or **L2** on the handset, or LINE1 or LINE2 indicator on the base unit flashes rapidly. You can answer the 2nd call while holding the 1st call.

You can also make a call without ending the 1st call.

Handset

Example: If you are using line 1

- 1 Press **[HOLD]** 2 times to put the 1st call (line 1) on hold.
- 2 Press **[LINE2]** to make or answer a 2nd call.
 - To hold the 2nd call, press **[HOLD]** 2 times.
- 3 To return to the 1st call (line 1), press **[LINE1]**.

Note:

- If you subscribe to Caller ID, the 2nd caller's information is displayed when a call is being received on the other line (page 32).

Base unit

Example: If you are using line 1

- 1 Press **[HOLD]** to put the 1st call (line 1) on hold.

- 2 Press **[LINE2]** to make or answer a 2nd call.
 - To hold the 2nd call, press **[HOLD]**.
- 3 To return to the 1st call (line 1), press **[LINE1]**.

Handset phonebook

You can add up to 50 items to the handset phonebook and search for phonebook items by name.

Adding items to the handset phonebook

1 [▲] or [▼] → [📖]

2 [ADD]

3 Enter the name (max. 16 characters).
→ [NEXT]

4 Enter the phone number (max. 32 digits). → [NEXT]

5 [SAVE]

- To add other items, repeat from step 2.

6 [OFF]

PAUSE button (for PBX/long distance service users)

A pause is sometimes required when making calls using a PBX or long distance service. When storing a calling card access number and/or PIN in the phonebook, a pause is also needed (page 30).

For example, if you need to dial the line access number "9" when making outside calls with a PBX:

In step 4, press [9], [PAUSE], then enter the phone number.

Note:

- A 3.5 second pause is inserted each time [PAUSE] is pressed. Press repeatedly to insert longer pauses.

Character table for entering names

Key	Character
[1]	& ' () , - . / 1
[2]	a b c A B C 2
[3]	d e f D E F 3
[4]	g h i G H I 4
[5]	j k l J K L 5
[6]	m n o M N O 6
[7]	p q r s P Q R S 7
[8]	t u v T U V 8
[9]	w x y z W X Y Z 9
[0]	0 Space
[#]	#
[*]	*

Note:

- To enter another character that is located on the same dial key, first press [▶] to move the cursor to the next space.

Editing/correcting a mistake

Press [◀] or [▶] to move the cursor to the character or number you want to erase, then press [CLEAR]. Enter the appropriate character or number.

Note:

- Press and hold [CLEAR] to erase all characters or numbers.

Finding and calling a handset phonebook item

Phonebook items can be searched for alphabetically by scrolling through the phonebook items or by initial.

Once you have found the desired item, press **[↵]** to dial the number.

- You can also make a call by pressing **[CALL]**, then pressing **[LINE1]** or **[LINE2]**.

Searching for a name alphabetically by scrolling through all items

1 **[▲]** or **[▼]** → **[📖]**

2 Press **[▲]** or **[▼]** to select the desired item.

Searching for a name by initial

1 **[▲]** or **[▼]** → **[📖]**

2 Press the dial key (**[0]** – **[9]**, **[#]**, or **[*]**) that corresponds to the first letter you are searching for (see the character table, page 28).

Example: “LISA”

Press **[5]** repeatedly to display the first phonebook entry starting with the initial “L” and go to step 3.

- If there is no item corresponding to the letter you selected, the next item is displayed.

3 Press **[▼]** to select the desired item.

Editing items in the handset phonebook

- 1** Find the desired item (page 29). → **[EDIT]**
- 2** Edit the name if necessary (page 28). → **[NEXT]**
- 3** Edit the phone number if necessary. → **[NEXT]** → **[SAVE]** → **[OFF]**

Erasing an item in the handset phonebook

- 1** Find the desired item (page 29).
- 2** **[ERASE]** → **[YES]** → **[OFF]**

Chain dial

This feature allows you to dial phone numbers in the handset phonebook while you are on a call. This feature can be used, for example, to dial a calling card access number or bank account PIN that you have stored in the handset phonebook, without having to dial manually.

- 1 Press **[MENU]** during an outside call.
- 2 Press **[1]** to select "Phonebook".
- 3 Find the desired item (page 29). → **[CALL]**

Note:

- When storing a calling card access number and your PIN in the phonebook as one phonebook item, press **[PAUSE]** to add pauses after the number and PIN as necessary (page 28).
- If you have rotary or pulse service, you need to press **[*]** before pressing **[MENU]** in step 1 to change the dialing mode temporarily to tone.

Copying handset phonebook items

You can copy one or all of the phonebook items from the handset to the phonebook of a compatible Panasonic handset (KX-TGA670).

Copying an item

- 1 **[MENU]** → **[#][1]**
- 2 Select the handset to copy to. → **[NEXT]**
- 3 Press **[▲]** or **[▼]** to select the desired item. → **[SEND]**
 - To continue copying another item, repeat from step 3.
- 4 Press **[OFF]** after the long beep.

Copying all items

- 1 **[MENU]** → **[#][2]**
- 2 Select the handset to copy to. → **[SEND]**
- 3 Press **[OFF]** after the long beep.

Base unit speed dialer

You can assign one phone number to each of the 10 dial keys ([0] – [9]) on the base unit.

Adding phone numbers to the speed dialer

Important:

- Before adding phone numbers, make sure the base unit is not being used.

1 [PROGRAM]

2 Enter the phone number (max. 32 digits).

- If a pause is required for dialing, press [PAUSE] where needed.
- If you misdial, press [STOP] and repeat from step 1.

3 [PROGRAM]

4 Press a dial key ([0] – [9]).

Note:

- If a phone number is assigned to a dial key which already contains a phone number, the old number will be erased.
- We recommend you make a note of which phone numbers are stored in which dial keys.

PAUSE button (for PBX/long distance service users)

A pause is sometimes required when making calls using a PBX or long distance service.

For example, if you need to dial the line access number “9” when making outside calls with a PBX:

In step 2, press [9], [PAUSE], then enter the phone number.

Note:

- A 3.5 second pause is inserted each time [PAUSE] is pressed. Press repeatedly to insert longer pauses. “P” is displayed when [PAUSE] is pressed.
- When [✖] is pressed, “L” is displayed. When [≡] is pressed, “≡” is displayed.

To erase a stored phone number

1 Press [PROGRAM] 2 times.

2 Press the desired dial key ([0] – [9]).

Calling someone with the speed dialer

1 [SP-PHONE] → [AUTO]

2 Press the desired dial key ([0] – [9]).

Note:

- Speed dial numbers assigned to the base unit dial keys can only be dialed from the base unit.

Using Caller ID service

This unit is Caller ID compatible. To use Caller ID features, you must subscribe to Caller ID service of your telephone service provider.

Caller ID features

When an outside call is being received, the calling party's name and telephone number are displayed.

Caller information for the last 50 different callers is logged in the caller list by the most recent call to the oldest.

- Generally caller information is displayed from the 2nd ring.
- If the unit cannot receive caller information, the following is displayed:
 - **“Out of area”**: The caller dialed from an area which does not provide Caller ID service.
 - **“Private caller”**: The caller requested not to send caller information.
 - **“Long distance”**: The caller called you long distance.
- If the unit is connected to a PBX system, caller information may not be received properly. Consult your PBX supplier.

Missed calls

If a call is not answered, the unit treats the call as a missed call. The number of missed calls is shown on the handset display. This lets you know if you should view the caller list to see who called while you were out.

Private name display

When caller information is received and it matches a phone number stored in the phonebook, the stored name is displayed and logged in the caller list.

Call Waiting Caller ID display

If you subscribe to both Caller ID and Call Waiting with Caller ID services, the 2nd caller's information is displayed after you hear a Call Waiting tone (page 25). Please contact your telephone service provider for details and availability of this service in your area.

Caller list

Viewing the caller list and calling back

- 1 **[▲]** or **[▼]** → **[CID]**
- 2 Press **[▼]** to search from the most recent call, or **[▲]** to search from the oldest call.
- 3 **[↶]**

Note:

- If the indicated line is already being used or you want to select the other line, press **[CALL]** in step 3 then select the desired line by pressing **[LINE1]** or **[LINE2]**.

Displayed symbols

- **1** and **2** indicate which line the caller information was received from.
- If the same caller calls more than once, it is displayed with the number of times the caller called ("x2" to "x9"). Only the date and time of the most recent call is stored.
- A **✓** is displayed next to items which have already been viewed or answered.

Editing a caller's phone number before calling back

You can edit a phone number in the caller list by removing its area code and/or the long distance code "1".

- 1 **[▲]** or **[▼]** → **[CID]**
- 2 Select the desired item. → **[CALL]**
- 3 Press **[EDIT]** repeatedly until the phone number is shown in the desired format.
 - ① Local phone number
Example:
 - ② Area code – Local phone number
Example:
 - ③ 1 – Area code – Local phone number
Example:

4 **[↶]**

Caller ID number auto edit feature

Once you call back an edited number, the unit will remember the Area Code and Format of the Edited Number. Next time when someone calls from the same Area Code, caller information will be customized by the unit as follows:

- when the call is being received, the Caller ID number will be displayed in the same Format as the Edited Number.
- after the call is ended, the telephone number of the caller, when reviewed from the Caller list, will be displayed in the same Format as the Edited Number.

For example, you can use this feature to set the unit to ignore the area code of callers in your area code, so that you can call these local numbers using caller information without dialing the area code. To activate this feature, you must edit an item in the caller list, then call that number. After that, phone numbers from that caller's area code are edited automatically. This feature can be turned on or off (page 37).

Note:

- Phone numbers from the 4 most recently edited area codes are automatically edited.
- If you move to another area, you can turn this feature off to erase previously edited area codes. To use this feature again, turn it on and reprogram the area codes you want to edit once again.

Storing caller information into the handset phonebook

- 1** [**▲**] or [**▼**] → [**CID**]
- 2** Select the desired item. → [**SAVE**]
 - To edit the number, press [**EDIT**] repeatedly until the phone number is shown in the desired format.
- 3** [**SAVE**]
 - If there is the name information for the caller, skip to step 5.
- 4** Enter the name (see the character table, page 28). → [**NEXT**] → [**SAVE**]
- 5** [**OFF**]

Erasing selected caller information

- 1** [**▲**] or [**▼**] → [**CID**]
- 2** Select the desired item.
- 3** [**ERASE**] → [**YES**] → [**OFF**]

Erasing all caller information

- 1** [**▲**] or [**▼**] → [**CID**]
- 2** [**ERASE**] → [**YES**]

Programmable settings

You can customize the unit by programming the following features using the handset. To access the features, there are 2 methods:

- scrolling through the display menus (page 35)
- using the direct commands (page 37)
- The direct command method is mainly used in these operating instructions.

Programming by scrolling through the display menus

1 [MENU]

2 Press **[▲]** or **[▼]** to select the desired menu. → **[SELECT]**

- If there are sub-menu(s), press **[▲]** or **[▼]** to select the desired item. → **[SELECT]**

Example: To access the handset ringer volume setting

Press **[▲]** or **[▼]** to select “**Ringer setting**”. → **[SELECT]**

Then press **[▲]** or **[▼]** to select “**Ringer volume**”. → **[SELECT]**

3 Press **[▲]** or **[▼]** to select desired line.

- This step may not be necessary depending on the feature being programmed.

4 Press **[▲]** or **[▼]** to select the desired setting.

- This step may vary depending on the feature being programmed.

5 [SAVE] → [OFF]

Main menu	Sub-menu 1	Sub-menu 2	Page
Message playback	–	–	42, 43
Phonebook	–	–	28
Ringer setting	Ringer volume	–	–
	Ringer tone	–	–
	Interrupt tone	–	–
Date and time ^{*1}	–	–	19
Voice enhancer	–	–	26
Copy phonebook	Copy 1 item	–	30
	Copy all items	–	30

Programming

Main menu	Sub-menu 1	Sub-menu 2	Page
Initial setting	Set answering	Ring count ^{*1}	47
		Recording time ^{*1}	47
		Remote code ^{*1}	48
		Recording mode ^{*1}	48
	Message alert	–	48
	LCD contrast	–	–
	Key tone	–	–
	Auto talk	–	23
	Room monitor	–	53
	Caller ID edit	–	34
	Set tel line	Line select	20
		Set dial mode ^{*1}	19
		Set flash time ^{*1}	–
		Set line mode ^{*1}	–
	Set base unit	Ringer volume ^{*1}	–
		Ringer tone ^{*1}	–
		Interrupt tone ^{*1}	–
		Room monitor ^{*1}	53
		Line select ^{*1}	20
	Registration	HS registration	54
		Deregistration	54
	Change language	–	19

*1 If you program these settings using one of the handsets, you do not need to program the same item using another handset.

Programming using the direct commands

1 [MENU]

2 Enter the desired feature code.

3 Enter the desired setting code.

- This step may vary depending on the feature being programmed.

4 [SAVE] → [OFF]

Note:

- In the following table, < > indicates the default setting.
- If you make a mistake or enter the wrong code, press [OFF], then start again from step 1.

Feature	Feature code	Setting code	Page
Auto talk ^{*2*3}	[0][3]	[1]: On [0]: <Off>	23
Caller ID edit (Caller ID number auto edit)	[0][4]	[1]: <On> [0]: Off	34
Change language (Display language)	[0][8]	[1]: <English> [2]: Español	19
Copy phonebook (Copy 1 item)	[#][1]	–	30
Copy phonebook (Copy all items)	[#][2]	–	30
Date and time ^{*1}	[4]	–	19
Deregistration	[0][0][2]	–	54
HS registration (Handset registration)	[0][0][1]	–	54
Interrupt tone ^{*4} (Handset)	[1][3]	[1]: On [2]: <2> [0]: Off	–
Interrupt tone ^{*1*4} (Base unit)	[0][*][2]		–
Key tone ^{*5}	[0][2]	[1]: <On> [0]: Off	–
LCD contrast (Display contrast)	[0][1]	[1]–[6]: Level 1–6 <3>	–

Programming

Feature	Feature code	Setting code	Page
Line select (Handset)	[0][5][5]	[1]: Line1 [2]: Line2 [0]: <Auto>	20
Line select ^{*1} (Base unit)	[0][*][5]		20
Message alert	[0][#]	[1]: On [0]: <Off>	48
Message playback	[2]	–	42, 43
Phonebook	[*]	–	28
Recording mode ^{*1}	[0][6][4]	[1]: <Standard recording 60min> [2]: Enhanced recording 30min	48
Recording time ^{*1}	Line1	[0][6][2][1]	[1]: 1min [2]: 2min [3]: <3min> [0]: Greeting only
	Line2	[0][6][2][2]	
Remote code ^{*1}	[0][6][3]	Default: 11	48
Ring count ^{*1}	Line1	[0][6][1][1]	[2]–[7]: 2–7 rings <4> [0]: Toll saver
	Line2	[0][6][1][2]	
Ringer tone ^{*6} (Handset)	Line1	[1][2][1]	[1]–[4]: Tone 1–4 [5]–[8]: Melody 1–4 Line 1: <Tone 1> Line 2: <Tone 2>
	Line2	[1][2][2]	
Ringer tone ^{*1*6} (Base unit)	Line1	[0][*][1][1]	–
	Line2	[0][*][1][2]	
Ringer volume (Handset)	Line1	[1][1][1]	[1]–[3]: Level 1–3 <3> [0]: Off
	Line2	[1][1][2]	
Ringer volume ^{*1} (Base unit)	Line1	[0][*][6][1]	–
	Line2	[0][*][6][2]	
Room monitor (Handset)	[0][9]	[1]: On [0]: <Off>	53
Room monitor ^{*1} (Base unit)	[0][*][3]		53
Set dial mode ^{*1}	[0][5][1]	[1]: Pulse [2]: <Tone>	19

Feature		Feature code	Setting code	Page
Set flash time ^{*1*7}	Line1	[0][5][2][1]	[1]: <700ms>	-
	Line2	[0][5][2][2]	[2]: 600ms [3]: 400ms [4]: 300ms [5]: 250ms [6]: 110ms [7]: 100ms [8]: 90ms	
Set line mode ^{*1*8}	Line1	[0][5][3][1]	[1]: A [2]: 	-
	Line2	[0][5][3][2]		
Voice enhancer		[5]	[1]: On [0]: <Off>	26

- *1 If you program these settings using one of the handsets, you do not need to program the same item using another handset.
- *2 If you set the line selection mode from "Auto" to "Line1" or "Line2" (page 20), the auto talk feature will function for that line only. If the other line receives a call, the auto talk feature does not function.
- *3 If you subscribe to Caller ID service and want to view the caller's information after lifting up the handset to answer a call, turn off this feature.
- *4 This tone lets you know when you receive a call while you are on the other line, on an intercom call, or monitoring a room. If you select "On", the tone sounds repeatedly for as long as the line rings. If you select "2", the tone only sounds 2 times.
- *5 Turn this feature off if you prefer not to hear key tones while you are dialing or pressing any keys, including confirmation tones and error tones.
- *6 If you subscribe to a distinctive ring service (such as IDENT-A-RING), select a tone (tone 1 to 4). If you select a melody, you cannot distinguish lines by their ringers.
- *7 The flash time depends on your telephone exchange or host PBX. Consult your PBX supplier if necessary. The setting should stay at "700ms" unless pressing **[FLASH]** fails to pick up the call waiting call.
- *8 Generally, the line mode setting should not be adjusted. If **L1** or **L2** is not displayed on the handset or the LINE1 or LINE2 indicator on the base unit does not light properly when another phone connected to the same line is in use, you need to change the line mode to "A".

Answering system

Important:

- Only 1 person can access the answering system at a time.
- When callers leave messages, the unit records the day and time of each message. Make sure the date and time have been correctly set (page 19).

Memory capacity

The total recording capacity (including your greeting message, caller messages, and voice memos) is about 60 minutes. A maximum of 99 messages can be recorded.

- If the message memory becomes full, the **[ANSWER ON]** button on the base unit flashes rapidly. Erase unnecessary messages (page 42).
- If less than 10 minutes of recording time are available, the unit announces the remaining recording time when operating the answering system. Erase unnecessary messages (page 42).

Turning the answering system on

Base unit

Press the **[LINE SELECT]** repeatedly to select the desired line(s). → **[ANSWER ON]**

- The **[ANSWER ON]** button lights.

Turning the answering system off

Base unit

Press **[ANSWER ON]**.

- The **[ANSWER ON]** button turns off.

Screening calls

While a caller is leaving a message, you can listen to the call through the base unit speakers. To adjust the speaker volume, press **[▲]** or **[▼]** repeatedly.

To answer the call, press **[LINE1]** or **[LINE2]** being called on the base unit or **[LINE1]** or **[LINE2]** being called on the handset.

Turning off the call screening feature

When the base unit is not in use, press **[GREETING CHECK]**, then press **[▼]** repeatedly until "0" is displayed.

OR

While screening, press **[▼]** repeatedly until "0" is displayed.

Note:

- If you adjust the speaker volume while listening to messages or talking on the intercom, the speaker volume for call screening is turned on again.

Recording your greeting message

You can record your own greeting message (max. 2 minutes) that is played when the answering system answers a call.

The greeting messages can be recorded:

- for each line.
 - for both lines using a common greeting.
- If you do not record a greeting message, a prerecorded greeting message is used.

Base unit

- 1** Press **[LINE SELECT]** repeatedly to select the desired line(s).
- 2** **[GREETING REC]**
- 3** Within 10 seconds, press **[GREETING REC]** again.
- 4** After the base unit beeps, speak clearly about 20 cm (8 inches) away from the MIC.
- 5** To stop recording, press **[STOP]**.

Playing back the greeting message

- 1** Press **[LINE SELECT]** repeatedly to select the desired line(s).
- 2** **[GREETING CHECK]**.

Erasing your greeting message

- 1** Press **[LINE SELECT]** repeatedly to select the desired line(s).
- 2** Press **[GREETING CHECK]**, and then press **[ERASE]** while your greeting message is playing.

Prerecorded greeting message

If you erase or do not record your own greeting message, the unit plays a prerecorded greeting message for callers and ask them to leave messages.

If the message recording time (page 47) is set to “**Greeting only**”, caller messages are not recorded and the unit plays a different prerecorded greeting message asking callers to call again.

Base unit

To play back the prerecorded greeting message.

Press **[LINE SELECT]** repeatedly to select the desired line(s). → **[GREETING CHECK]**

Note:

- If you changed the caller’s recording time to “**Greeting only**” to listen to its prerecorded message, remember to reset your original setting (page 47).

Listening to messages using the base unit

The base unit plays messages, including memo messages, on the line selected for the answering system. In standby mode, the selected line is indicated by **■** or **■** on the base unit.

When new messages have been recorded, the **[MESSAGE]** button on the base unit flashes.

Press **[MESSAGE]**.

- When you have new messages, the unit plays only new messages.
- When you have no new messages, the unit plays back all messages.

Playing back messages for the desired line(s)

Press **[LINE SELECT]** repeatedly to select the desired line(s), then press **[MESSAGE]**.

Note:

- After selecting the line(s), memo messages do not play.

Adjusting the speaker volume

Press **[▲]** or **[▼]** repeatedly while listening to a message.

Repeating a message

Press **[◀◀]** during playback.

- If pressed within the first 5 seconds of a message, the previous message is played.

Skipping a message

Press **[▶▶]** during playback.

Pausing a message

Press **[STOP]** during playback.

- To resume playback, press **[MESSAGE]**.
- To stop playback completely, press **[STOP]** again.

Erasing a message

Press **[ERASE]** during playback.

Erasing all messages

Press **[ERASE]** 2 times while the unit is not being used.

- All messages including memo messages are erased.

Erasing all messages for the desired line(s)

1 Press **[LINE SELECT]** repeatedly to select the desired line(s).

- The number of the messages on the selected line(s) is displayed and the messages on the line(s) will be erased in step 3.

2 Press **[ERASE]**.

- The base unit displays the number of all messages on the both lines and memo messages regardless of the selected line(s).

3 Press **[ERASE]** again.

- The messages on the selected line(s) in step 1 are erased.

Listening to messages using the handset

When new messages have been recorded:

- “**New message**” is displayed.
- the message indicator on the handset slowly flashes in amber if the message alert feature is turned on (page 48).

1 [▲] or [▼] → [PLAY]

- The handset plays new messages including memo messages.
- When you have no new messages, the handset plays back all messages.

2 When finished, press [OFF].

Note:

- To switch to the receiver, press [↶].

Adjusting the receiver/speaker volume

Press [▲] or [▼] repeatedly while listening to a message.

Voice guidance

If you do not press any buttons after the last message is played back, the unit’s voice guidance starts. Operate the answering system by following the guidance as necessary.

Calling back (Caller ID subscribers only)

If Caller ID information was received for the call, you can call the caller back while listening to the message.

1 Press [CALL] during playback.

- To edit the number before calling back, press [EDIT] repeatedly to select the desired format (page 33).

2 [↷]

- If the indicated line is already being used or you want to select the other line, select the desired line by pressing [LINE1] or [LINE2] instead of [↷].

Answering system commands

You can also select the desired line(s) and press dial keys to access certain answering system functions using the handset during playback.

1 [MENU] → [2]

2 Select the desired line(s) if necessary.

For line 1: [≡][1]

For line 2: [≡][2]

For line 1 and line 2: [≡][0]

- After selecting the line(s), memo messages do not play.

3 Press the desired dial keys.

Key	Command
[1] or [◀]	Repeat message (during playback). ^{*1}
[2] or [▶]	Skip message (during playback).
[4]	Play new messages.
[5]	Play all messages.
[9]	Stop playback. ^{*2}
[0]	Turn answering system off.
[*][4] or [ERASE]	Erase currently playing message.

Key	Command
[*][5]	Erase all messages.
[#][1][8]	Turn answering system on for line 1 only.
[#][2][8]	Turn answering system on for line 2 only.
[#][0][8]	Turn answering system on for both line 1 and line 2.

- *1 If pressed within the first 5 seconds of a message, the previous message is played.
- *2 To resume operation, press a command key within 15 seconds, or the voice guidance starts.

Voice memo

Recording a voice memo

You can use the base unit to leave a voice memo (voice message) for yourself or someone else (max. 3 minutes). Voice memos can be played back later with the same operation used to play back answering system messages.

Base unit

- 1 [MEMO]**
- 2** After the unit beeps, speak clearly about 20 cm (8 inches) away from the MIC.
- 3** To stop recording, press **[STOP]**.

Remote operation

Using a touch tone phone, you can call your phone number from outside and access the unit to listen to messages. The unit's voice guidance prompts you to press certain dial keys to perform different operations.

Important:

- In order to operate the answering system remotely, you must first set a remote code (page 48). This code must be entered each time you operate the answering system remotely.

Using the answering system remotely

- 1 Dial your phone number from a touch tone phone.
- 2 After the greeting message starts, enter your remote code (page 48).
 - The unit plays back new messages including memo messages.
 - After playing back new messages, the voice guidance starts.
- 3 Follow the voice guidance as necessary.
- 4 When finished, hang up.

Note:

- You can ignore the voice guidance and control the unit using remote commands (page 45).

Voice guidance

During remote operation, the unit's voice guidance prompts you to press **[1]** to perform a specific operation, or press **[2]** to listen to more available operations. Operations are presented by voice guidance in the following order:

- Play back all messages
- Play back new messages
- Record your message
- Erase all messages
- Record your greeting message

Note:

- If you do not press any dial keys within 10 seconds after a voice guidance prompt, the unit disconnects your call.
- If less than 10 minutes of recording time is available, the unit announces the remaining recording time after the last message is played back.

Remote commands

You can select the desired line(s) and press dial keys to access certain answering system functions without waiting for the voice guidance to prompt you.

- 1 Select the desired line(s) while you are accessing the answering system if necessary.
 - For line 1: **[#][1]**
 - For line 2: **[#][2]**
 - For line 1 and line 2: **[#][0]**
 - After selecting the line(s), memo messages do not play.
- 2 Press the desired dial keys.

Key	Remote command
[1]	Repeat message (during playback). ^{*1}
[2]	Skip message (during playback).
[4]	Play new messages.
[5]	Play all messages.
[9]	Stop recording/ playback. ^{*2}
[0]	Turn answering system off.
[*][4]	Erase currently playing message.
[*][5]	Erase all messages.
[#][1][7]	Record a greeting message for line 1 only.
[#][2][7]	Record a greeting message for line 2 only.
[#][0][7]	Record a common greeting message for both line 1 and line 2.
[#][1][8]	Turn answering system on for line 1 only.
[#][2][8]	Turn answering system on for line 2 only.
[#][0][8]	Turn answering system on for both line 1 and line 2.

*1 If pressed within the first 5 seconds of a message, the previous message is played.

*2 To resume operation, enter a remote command within 15 seconds, or the voice guidance starts.

Turning on the answering system remotely

If the answering system is off, you can turn it on remotely by calling the selected line in "Turning the answering system on" on page 40.

- 1 Dial your phone number.
- 2 Let the phone ring 15 times.
 - The unit answers your call with the greeting message.
 - You can hang up, or if you call from a touch tone phone, you can enter your remote code and begin remote operation (page 45).

Skipping the greeting message to leave a message

You can leave a message just as any outside caller can. Call your phone number. When the answering system picks up, press [*] to skip the greeting message and record your message after the beep.

Answering system settings

Ring count

You can change the number of times the phone rings before the unit answers calls. The default setting is "4".

"Toll saver": The unit answers on the 2nd ring when new messages have been recorded, and on the 4th ring when there are no new messages. If you call your phone from outside to listen to new messages (page 45), you will know that there are no new messages when the phone rings for the 3rd time. You can then hang up without being charged for the call.

Handset

1 [MENU] → [0][6][1]

2 Select the desired line.

3 Select the desired setting. → [SAVE] → [OFF]

For Voice Mail service subscribers

If you subscribe to a flat-rate service package that includes Caller ID, Call Waiting, Voice Mail, and unlimited local/regional/long distance calls, please note the following:

- To use the Voice Mail service provided by your telephone service provider rather than the unit's answering system, turn off the answering system (page 40). This unit does not have an indicator to indicate if there are new messages in your mailbox service.

- To use this unit's answering system rather than the Voice Mail service provided by your telephone service provider, please contact your telephone service provider to deactivate your Voice Mail service.

If your telephone service provider cannot do this:

- Set this unit's "Ring count" setting so that this unit's answering system answers calls before the Voice Mail service of your telephone service provider does. It is necessary to check the ring count required to activate the Voice Mail service provided by your telephone service provider before changing this setting.
- Change the ring count of the Voice Mail service so that the answering system can answer the call first. To do so, consult your telephone service provider.

Caller's recording time

You can change the maximum message recording time allotted to each caller. The default setting is "3min".

"Greeting only": The unit plays the greeting message but does not record caller messages.

Handset

1 [MENU] → [0][6][2]

2 Select the desired line.

3 Select the desired setting. → [SAVE] → [OFF]

Note:

- If the message memory becomes full, the unit automatically switches to the “**Greeting only**” mode and no new messages are recorded. If you have recorded your own greeting message, that same greeting message is announced to callers even though their messages are not recorded. If you have not recorded your own greeting message, the prerecorded message used for “**Greeting only**” mode is announced to callers (page 41).

Remote code

A remote code must be entered when operating the answering system remotely. This code prevents unauthorized parties from listening to your messages remotely. The default setting is “11”.

Handset

1 [MENU] → [0][6][3]

2 Enter the desired 2-digit remote code.
→ **[SAVE] → [OFF]**

Recording mode

You can select a recording mode. Enhanced recording provides improved sound quality, but the total recording capacity is reduced. The default setting is “**Standard recording 60min**”.

Handset

1 [MENU] → [0][6][4]

2 Select the desired setting. → **[SAVE] → [OFF]**

Message alert

You can select whether or not the message indicator on the handset slowly flashes in amber when new messages are recorded (page 43). The default setting is “**Off**”.

Handset

1 [MENU] → [0][#]

2 Select the desired setting. → **[SAVE] → [OFF]**

Note:

- While message alert feature is on, battery operating time is shortened (page 14).
- If you have new messages and message alert feature is on, the message indicator does not indicate battery charge status (page 13). The indicator slowly flashes in amber until you listen to all new messages.

Intercom

Intercom calls can be made:

- between the handset and base unit
- between handsets

Note:

- If you receive an outside call while talking on the intercom, you hear 2 tones (page 37). To answer the call with the handset, press **[LINE1]** or **[LINE2]** that is flashing on the handset. To answer the call with the base unit, press **[LINE1]** or **[LINE2]** that is flashing on the base unit.
- You can locate a misplaced handset by paging it (handset locator).

Making an intercom call

Handset

1 **[INTERCOM]**

2 To page the base unit, press **[0]**.
To page another handset, enter its extension number (**[1]** – **[8]**).

- The destination unit beeps for 1 minute.
- To stop paging, press **[OFF]**.

3 When you finish talking, press **[OFF]**.

Base unit

1 **[INTERCOM]**

2 To page a specified handset, enter its extension number (**[1]** – **[8]**).
To page all handsets, press **[0]**.

- The destination unit(s) beeps for 1 minute.

- To stop paging, press **[INTERCOM]**.
- Even if you call all handsets, only the handset user who answers first can take the intercom call.

3 When you finish talking, press **[SP-PHONE]**.

Answering an intercom call

Handset

1 Press **[hook]** to answer the page.

2 When you finish taking, press **[OFF]**.

Base unit

1 Press **[INTERCOM]** to answer the page.

2 When you finish talking, press **[INTERCOM]**.

Note for handset and base unit:

- The ringer volume for intercom calls follows the higher volume level of the 2 lines (page 38).
- When the ringer volume is set to off for both lines, the handset or the base unit rings at the low level for intercom calls.

Transferring calls

Outside calls can be transferred between the handset and base unit, and between 2 handsets.

Handset

- 1 During an outside call, press **[INTERCOM]** to put the call on hold.
- 2 To page the base unit, press **[0]**.
To page another handset, enter its extension number (**[1] – [8]**).
 - If you do not wish to announce the transfer, skip to step 4.
- 3 Wait for the paged party to answer.
 - If the paged party does not answer, press **[LINE1]** or **[LINE2]** that is flashing on the handset to return to the outside call.
- 4 To complete the transfer, press **[OFF]**.
 - The outside call is being routed to the unit.

Base unit

- 1 During an outside call, press **[INTERCOM]** to put the call on hold.
- 2 To page a specified handset, enter its extension number (**[1] – [8]**).
To page all handsets, press **[0]**.
 - If you do not wish to announce the transfer, skip to step 4.
 - Even if you call all handsets, only the handset user who answers first can take the transferred call.

- 3 Wait for the paged party to answer.
 - If the paged party does not answer, press **[LINE1]** or **[LINE2]** that is flashing to return to the outside call.
- 4 To complete the transfer, press **[SP-PHONE]**.
 - The outside call is being routed to the handset.

Answering transferred calls

Handset

Press **[↶]** to answer the page.

Base unit

Press **[INTERCOM]** to answer the page.

Note for handset and base unit:

- After the paging party disconnects, you can talk to the outside caller.
- If the paging party hangs up before you answer the page, "Incoming call" is displayed. Press **[LINE1]** or **[LINE2]** on the handset or **[LINE1]** or **[LINE2]** on the base unit to take the transferred call.

Transferring a call to the answering system

When you answer a call and the caller wants to talk to someone who is not available, you can transfer the caller to the answering system, where the caller can leave a message.

Tell the outside caller you will transfer him or her to the answering system.

Handset

- 1 During an outside call, press **[INTERCOM]** to put the call on hold.
- 2 Press **[9]** to hang up the call.

Base unit

- 1 During an outside call, press **[INTERCOM]** to put the call on hold.
- 2 Press **[9]** to hang up the call.

Note for handset and base unit:

- After you press **[9]**, the caller hears the greeting message (page 41) and can leave a message after the beep.

Conference calls

Conference call with 2 outside calls

While you are talking with an outside caller, you can make or answer a 2nd call on the other line, and then combine the calls to establish a conference call.

Handset

- 1 During an outside call, press **[HOLD]** 2 times.
- 2 To answer a 2nd call, press **[LINE1]** or **[LINE2]**.
To make a 2nd call, press **[LINE1]** or **[LINE2]**, then dial the phone number.
- 3 When the 2nd call is connected, press **[CONF]** to make a conference call.
 - To hang up only one line, press **[LINE1]** or **[LINE2]** for the party with which you want to continue talking.
 - To put both lines on hold, press **[HOLD]**. To talk with only one caller, press **[LINE1]** or **[LINE2]** for the party with which you want to continue talking. To resume both lines, press **[CONF]**.

Base unit

- 1 During an outside call, press **[HOLD]**.
- 2 To answer a 2nd call, press **[LINE1]** or **[LINE2]**.
To make a 2nd call, press **[LINE1]** or **[LINE2]**, then dial the phone number.

Multi-unit Operation

- When the 2nd call is connected, press **[CONF]** to make a conference call.
 - To hang up only one line, press **[LINE1]** or **[LINE2]** for the party with which you want to continue talking.
 - To put both lines on hold, press **[HOLD]**. To talk with only one caller, press **[LINE1]** or **[LINE2]**. To resume both lines, press **[CONF]**.

Note for handset and base unit:

- A maximum of 4 parties (including 1 or 2 outside parties) can join a conversation.

Conference call with an outside call and an intercom call

While you are talking with an outside caller, one more extension can join the conversation and establish a conference call.

Handset

- During an outside call, press **[INTERCOM]** to put the call on hold.
- To page the base unit, press **[0]**. To page another handset, enter its extension number (**[1] – [8]**).
- When the paged party answers, press **[CONF]** to make a conference call.
 - To leave the conference, press **[OFF]**. The other 2 parties can continue the conversation.

Base unit

- During an outside call, press **[INTERCOM]** to put the call on hold.

- To page a specified handset, enter its extension number (**[1] – [8]**). To page all handsets, press **[0]**.
- When the paged party answers, press **[CONF]** on the base unit to make a conference call.
 - To leave the conference, press **[SP-PHONE]**. The other 2 parties can continue the conversation.

Note for handset and base unit:

- The outside call can be put on hold by pressing **[HOLD]**. Only the person who placed the call on hold can resume the full conference by pressing **[CONF]** on the handset or **[CONF]** on the base unit.
- A maximum of 4 parties (including 1 or 2 outside parties) can join a conversation.

Room monitor

This feature allows you to monitor the room where a unit is located. The monitored unit does not ring, allowing you to easily monitor a baby's room, for example, from different areas of the house.

Note:

- You can place the handset on the base unit or charger while monitoring using the speakerphone.

Setting room monitor

To use the room monitor feature, you need to set the destination unit to be monitored beforehand.

- “0££” (Default): denies access from other units.
- “0α”: allows the unit to be monitored.

Turn on/off the handset's room monitor feature

Handset

- 1 **[MENU]** → **[0][9]**
- 2 Select the desired setting.
- 3 **[SAVE]** → **[OFF]**

Turn on/off the base unit's room monitor feature

Handset

- 1 **[MENU]** → **[0][*][3]**
- 2 Select the desired setting.

3 **[SAVE]** → **[OFF]**

Monitoring a room

Important:

- Before using this feature, set room monitor of the destination unit to “0α” to allow access by other units.
- If you receive an outside call while monitoring a room, you hear 2 tones (page 37). To answer the call with the handset, press **[LINE1]** or **[LINE2]** that is flashing on the handset. To answer the call with the base unit, press **[LINE1]** or **[LINE2]** that is flashing on the base unit.

Handset

1 **[INTERCOM]** → **[MONITOR]**

- 2 To page the base unit, press **[0]**. To page another handset, enter its extension number (**[1]** – **[8]**).
 - You can listen to the audio.

3 Press **[OFF]** to stop monitoring.

Base unit

1 **[INTERCOM]** → **[MUTE]**

- 2 To page a specified handset, enter its extension number (**[1]** – **[8]**).
 - You can listen to the audio.

3 Press **[INTERCOM]** to stop monitoring.

Registering a handset

The included handset and base unit are preregistered. If for some reason the handset is not registered to the base unit, register the handset.

Important:

- If you have already deregistered the handset, perform steps 2 and 3 only.

1 Handset:

[MENU] → [0][0][1]

2 Base unit:

Press and hold **[INTERCOM]** until the IN USE indicator flashes.

- After the IN USE indicator starts flashing, the rest of the procedure must be completed within 1 minute.

3 Handset:

Press **[OK]**, then wait until a beep sounds.

4 [OFF]

Registering an additional handset

See page 5 for information on the available model and extension numbers.

Start from step 2.

Deregistering a handset

Handset

1 [MENU] → [0][0][2]

2 [3][3][5] → [OK]

Additional accessories

Sales and support information

- To order replacement accessories, call 1-800-332-5368.
- TTY users (hearing or speech impaired users) can call 1-866-605-1277.

Headset (optional)

Connecting a headset to the handset allows hands-free phone conversations. We recommend using the Panasonic headset noted on page 5.

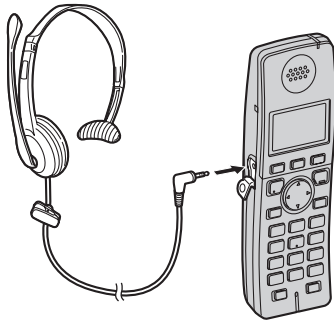

- Headset shown is KX-TCA86.

Switching a call between headset and handset speakerphone

To switch to the handset speakerphone, press **[↵]**.

To return to the headset, press **[↶]**.

Wall mounting (optional)

By purchasing the optional wall-mounting adaptor PQLK10078Z2, you can mount the base unit on a wall.

Belt clip (optional)

By purchasing the optional belt clip PQKE10457Z2, you can hang the handset on your belt or pocket.

Error messages

If the unit detects a problem, one of the following messages is shown on the display.

Display message	Cause/solution
Busy	<ul style="list-style-type: none">● The called handset or base unit is in use.● Other users are using the line(s). Wait until the line status icon goes out.● Privacy mode is on for the call you tried to join (page 26).● The handset you tried to copy phonebook items to is in use.● The handset you are calling is too far from the base unit.
Denied	<ul style="list-style-type: none">● The room monitor feature is turned off on the destination handset or base unit and the room cannot be monitored (page 53).
Error!!	<ul style="list-style-type: none">● The handset's registration has failed. Move the handset and base unit away from all electrical appliances and try again.● Another handset user tried to send phonebook items to you but there was an error. Have the other user re-send the items to you (page 30).
Error!! All handsets registered. Maximum is 8.	<ul style="list-style-type: none">● 8 handsets have already been registered to the base unit. A previously deregistered handset number may still be retained in the base unit. To register an additional handset, erase the unnecessary handset number using the base unit: Press and hold [INTERCOM] until the IN USE indicator flashes. → Press and hold the handset's extension number ([1] – [8]) that you want to cancel/delete from the base unit until a beep sounds.
---Incomplete---	<ul style="list-style-type: none">● The destination handset's phonebook memory is full. Erase unnecessary items from the destination handset's phonebook (page 29).● The destination handset is out of area.● The destination handset user may have pressed [↶] or [↷].

Display message	Cause/solution
Invalid	<ul style="list-style-type: none"> ● There is no handset registered to the base unit matching the extension number you entered. ● You selected your own extension number.
Invalid. Please register to the base unit	<ul style="list-style-type: none"> ● The handset is not registered to the base unit. Register the handset (page 54).
No items stored	<ul style="list-style-type: none"> ● Your phonebook or redial list is empty.
No link to base. Move closer to base, try again.	<ul style="list-style-type: none"> ● The handset has lost communication with the base unit. Move closer to the base unit, and try again. ● Confirm that the base unit's AC adaptor is plugged in. ● Raise the base unit antennas. ● The handset's registration may have been canceled. Re-register the handset (page 54).
Phonebook full	<ul style="list-style-type: none"> ● There is no space to store new items in the phonebook. Erase unnecessary items (page 29).
Please lift up and try again.	<ul style="list-style-type: none"> ● A handset button was pressed while the handset was on the base unit or charger. Lift the handset and press the button again.
System is busy. Please try again later.	<ul style="list-style-type: none"> ● Other units are in use and the system is busy. Try again later. ● Another user is listening to messages. Try again later.

Troubleshooting



General use

Problem	Cause/solution
The unit does not work.	<ul style="list-style-type: none">● Make sure the battery is installed correctly and fully charged (page 12).● Check the connections (page 9–11).● Unplug the base unit's AC adaptor to reset the unit. Reconnect the adaptor and try again.● The handset has not been registered to the base unit. Register the handset (page 54).
I cannot hear a dial tone.	<ul style="list-style-type: none">● Confirm the telephone line cord is properly connected (page 10).● Disconnect the unit from the telephone line and connect a known working telephone. If the working telephone operates properly, contact our service personnel to have the unit repaired. If the working telephone does not operate properly, contact your telephone service provider.

Programmable settings

Problem	Cause/solution
I cannot program items.	<ul style="list-style-type: none">● While another user is listening to messages or the answering system is answering a call, you cannot program items. Try again later.
While programming, the handset starts to ring.	<ul style="list-style-type: none">● A call is being received. Answer the call and start again after hanging up.

Battery recharge

Problem	Cause/solution
I fully charged the battery, but  continues to flash, or  is displayed.	<ul style="list-style-type: none">● Clean the charge contacts and charge again (page 13).● The battery may need to be replaced with a new one (page 12).
The handset display is blank.	<ul style="list-style-type: none">● Confirm that the battery is properly installed.● Fully charge the battery (page 13).

Making/answering calls, intercom

Problem	Cause/solution
Static is heard, sound cuts in and out. Interference from other electrical units.	<ul style="list-style-type: none"> ● Move the handset and base unit away from other electrical appliances. ● Move closer to the base unit. ● Raise the base unit antennas. ● Turn on the clarity booster feature (page 25). ● If your unit is connected to a telephone line with DSL service, we recommend connecting a noise filter between the base unit and the telephone line jack. Contact your DSL provider for details.
The handset and base unit do not ring.	<ul style="list-style-type: none"> ● The ringer volume is turned off. Adjust it (page 23, 38).
I cannot make a call.	<ul style="list-style-type: none"> ● The dialing mode may be set incorrectly. Change the setting (page 19). ● The base unit (including answering system) or another handset is in use. Try again later.
I cannot redial by pressing [REDIAL] .	<ul style="list-style-type: none"> ● If the last number dialed was more than 48 digits long, the number will not be redialed correctly. Dial the number manually.
I cannot have a conversation using the headset.	<ul style="list-style-type: none"> ● Make sure that an optional headset is connected properly (page 55). ● If “SP-phone” is displayed on the handset, press [] to switch to the headset.
I cannot make long distance calls.	<ul style="list-style-type: none"> ● Make sure that you have long distance service.
I cannot page the handset or base unit.	<ul style="list-style-type: none"> ● The called handset is too far from the base unit. ● The called unit is in use. Try again later.
I cannot turn the clarity booster on.	<ul style="list-style-type: none"> ● Another handset is already using this feature.

Useful Information

Caller ID

Problem	Cause/solution
The handset does not display the caller's name and/or phone number.	<ul style="list-style-type: none">● You have not subscribed to Caller ID service. Contact your telephone service provider to subscribe.● If your base unit is connected to any additional telephone equipment such as a Caller ID box or cordless telephone jack, disconnect the base unit from the equipment and plug the base unit directly into the wall jack.● If your base unit is connected to a telephone line with DSL service, we recommend connecting a noise filter between the base unit and the telephone line jack. Contact your DSL provider for details.● The name display service may not be available in some areas. Contact your telephone service provider for details.● Other telephone equipment may be interfering with this unit. Disconnect the other equipment and try again.● The caller requested not to send caller information (page 32).● If a call is being transferred to you, the caller information is not displayed.● Generally, caller information is displayed from the 2nd ring.
The caller list/incoming phone numbers are not edited automatically.	<ul style="list-style-type: none">● The Caller ID number auto edit feature is turned off. Turn it on and try again (page 37).● You need to call back the edited number to activate Caller ID number auto edit.
I cannot dial the phone number edited in the caller list.	<ul style="list-style-type: none">● The phone number you dialed might have an incorrectly edited pattern (for example, the long distance "1" or the area code is missing). Edit the phone number with another pattern (page 33).

Problem	Cause/solution
The 2nd caller's information is not displayed during an outside call.	<ul style="list-style-type: none"> ● In order to use Caller ID, Call Waiting, or Call Waiting Caller ID (CWID), you must first contact your telephone service provider and subscribe to the desired service. After subscribing, you may need to contact your telephone service provider again to activate this specific service, even if you already subscribed to both Caller ID and Call Waiting with Caller ID services (CWID).

Answering system

Problem	Cause/solution
I cannot listen to messages from a remote location.	<ul style="list-style-type: none"> ● A touch tone phone is required for remote operation. ● Enter the remote code correctly (page 45). ● The answering system is off. Turn it on (page 46).
The unit does not record new messages.	<ul style="list-style-type: none"> ● The answering system is not turned on for the line you wish to record messages from. Select the desired line or both lines by pressing [LINE SELECT] repeatedly, then turn the answering system on (page 40, 46). ● The recording time is set to "Greeting only". Select a different setting (page 47). ● The message memory is full. Erase unnecessary messages (page 42). ● The answering system is activated for both lines, and the 1st caller is leaving a voice message. The 2nd caller cannot leave a message, but the caller information will be stored (page 33). ● If you subscribe to the Voice Mail service, messages are recorded by the telephone service provider not your telephone (page 47).
I cannot operate the answering system.	<ul style="list-style-type: none"> ● Someone is operating the answering system. ● If someone is talking on a conference call, you cannot operate the answering system. Try again later.
The message indicator on the handset slowly flashes in amber.	<ul style="list-style-type: none"> ● New messages have been recorded. Listen to the new messages (page 42, 43).

FCC and other information

This equipment complies with Part 68 of the FCC rules and the requirements adopted by the ACTA. On the bottom of this equipment is a label that contains, among other information, a product identifier in the format US:ACJ-----.

If requested, this number must be provided to the telephone company.

- Registration No
.....(found on the bottom of the unit)
- Ringer Equivalence No.
(REN).....0.2B

A plug and jack used to connect this equipment to the premises wiring and telephone network must comply with the applicable FCC Part 68 rules and requirements adopted by the ACTA. A compliant telephone cord and modular plug is provided with the product. It is designed to be connected to a compatible modular jack that is also compliant.

The REN is used to determine the number of devices that may be connected to a telephone line. Excessive RENs on a telephone line may result in the devices not ringing in response to an incoming call. In most but not all areas, the sum of RENs should not exceed five (5.0). To be certain of the number of devices that may be connected to a line, as determined by the total RENs, contact the local telephone company. For products approved after July 23, 2001, the REN for the product is part of the product identifier that has the format US:AAAEQ##TXXXX. The digits represented by ## are the REN without a

decimal point (e.g., 03 is a REN of 0.3).

If this equipment causes harm to the telephone network, the telephone company will notify you in advance that temporary discontinuance of service may be required. But if advance notice isn't practical, the telephone company will notify the customer as soon as possible. Also, you will be advised of your right to file a complaint with the FCC if you believe it is necessary.

The telephone company may make changes in its facilities, equipment, operations or procedures that could affect the operation of the equipment. If this happens the telephone company will provide advance notice in order for you to make necessary modifications to maintain uninterrupted service.

If trouble is experienced with this equipment, for repair or warranty information, please contact a Factory Servicenter or other Authorized Servicer. If the equipment is causing harm to the telephone network, the telephone company may request that you disconnect the equipment until the problem is resolved.

Connection to party line service is subject to state tariffs. Contact the state public utility commission, public service commission or corporation commission for information.

If your home has specially wired alarm equipment connected to the telephone

line, ensure the installation of this equipment does not disable your alarm equipment. If you have questions about what will disable alarm equipment, consult your telephone company or a qualified installer.

This equipment is hearing aid compatible as defined by the FCC in 47 CFR Section 68.316.

When you hold the phone to your ear, noise might be heard in your Hearing Aid. Some Hearing Aids are not adequately shielded from external RF (radio frequency) energy. If noise occurs, use an optional headset accessory or the speakerphone option (if applicable) when using this phone. Consult with your audiologist or Hearing Aid manufacturer about the availability of Hearing Aids which provide adequate shielding to RF energy commonly emitted by digital devices.

WHEN PROGRAMMING EMERGENCY NUMBERS AND/OR MAKING TEST CALLS TO EMERGENCY NUMBERS:

- 1) Remain on the line and briefly explain to the dispatcher the reason for the call.
- 2) Perform such activities in the off-peak hours, such as early morning or late evenings.

This device complies with Part 15 of the FCC Rules. Operation is subject to the following two conditions:

(1) This device may not cause harmful interference, and (2) this device must accept any interference received, including interference that may cause undesired operation.

Privacy of communications may not be ensured when using this phone.

CAUTION:

Any changes or modifications not expressly approved by the party responsible for compliance could void the user's authority to operate this device.

NOTE:

This equipment has been tested and found to comply with the limits for a Class B digital device, pursuant to Part 15 of the FCC Rules. These limits are designed to provide reasonable protection against harmful interference in a residential installation. This equipment generates, uses, and can radiate radio frequency energy and, if not installed and used in accordance with the instructions, may cause harmful interference to radio communications. However, there is no guarantee that interference will not occur in a particular installation. If this equipment does cause harmful interference to radio or television reception, which can be determined by turning the equipment off and on, the user is encouraged to try to correct the interference by one or more of the following measures:

- Reorient or relocate the receiving antenna.
- Increase the separation between the equipment and receiver.
- Connect the equipment into an outlet on a circuit different from that to which the receiver is connected.
- Consult the dealer or an experienced radio/TV technician for help.

Some cordless telephones operate at frequencies that may cause interference to nearby TVs and VCRs. To minimize or prevent such interference, the base of the cordless telephone should not be placed near or on top of a TV or VCR. If interference is experienced, move the cordless telephone further away from the TV or VCR. This will often reduce, or eliminate, interference.

FCC RF Exposure Warning:

The product complies with FCC radiation exposure limits set forth for an uncontrolled environment. To comply with FCC RF exposure requirements, the base unit must be installed and operated with its antenna located 20 cm (8 inches) or more between antenna and all person's body (excluding extremities of hands, wrist and feet). The handset may be carried and operated with only the optional specific belt-clip. Other non-tested belt-clips or similar body-worn accessories may not comply and must be avoided. The product must not be collocated or operated in conjunction with any other antenna or transmitter.

Notice

- This product is designed for use in the United States of America. Sale or use of this product in other countries may violate local laws.
- Cet appareil est conçu pour être utilisé aux États-Unis d'Amérique. La vente ou l'emploi de cet appareil dans certains autres pays peut constituer une infraction à la législation locale.
- Este producto está diseñado para usarse en los Estados Unidos de América.
La venta o el empleo de este producto en ciertos países puede constituir violación de la legislación local.
- この製品は、日本国外での使用を目的として設計されており、日本国内での使用は法律違反となります。従って、当社では日本国内においては原則として修理などのサービスは致しかねます。

Specifications

General

Operating environment	5 °C – 40 °C (41 °F – 104 °F)
Frequency	5.76 GHz – 5.84 GHz

Base unit

Dimensions	Approx. height 55 mm x width 230 mm x depth 140 mm (2 ⁵ / ₃₂ inches x 9 ¹ / ₁₆ inches x 5 ¹ / ₂ inches)
Mass (Weight)	Approx. 460 g (1.01 lb.)
Power consumption	Standby: Approx. 2.1 W Maximum: Approx. 5.2 W
Power output	200 mW (max.)
Power supply	AC adaptor (120 V AC, 60 Hz)

Handset

Dimensions	Approx. height 156 mm x width 49 mm x depth 35 mm (6 ¹ / ₈ inches x 1 ¹⁵ / ₁₆ inches x 1 ³ / ₈ inches)
Mass (Weight)	Approx. 150 g (0.33 lb.)
Power output	200 mW (max.)
Power supply	Ni-MH battery (2.4 V, 830 mAh)

Charger

Dimensions	Approx. height 58 mm x width 87 mm x depth 95 mm (2 ⁹ / ₃₂ inches x 3 ⁷ / ₁₆ inches x 3 ³ / ₄ inches)
Mass (Weight)	Approx. 90 g (0.20 lb.)
Power consumption	Standby: Approx. 1.1 W Maximum: Approx. 3.4 W
Power supply	AC adaptor (120 V AC, 60 Hz)

Note:

- Design and specifications are subject to change without notice.
- The illustrations in these instructions may vary slightly from the actual product.

Customer services

Customer Services Directory

Obtain Product Information and Operating Assistance; locate your nearest Dealer or Servicenter; purchase Parts and Accessories; or make Customer Service and Literature requests by visiting our Web Site at:

<http://www.panasonic.com/consumersupport>

or, contact us via the web at:

<http://www.panasonic.com/contactinfo>

You may also contact us directly at: 1-800-211-PANA (1-800-211-7262),
Monday-Friday 9 am-9 pm; Saturday-Sunday 10 am-7 pm, EST.

TTY users (hearing or speech impaired users) can call 1-877-833-8855.

Accessory Purchases

Purchase Parts, Accessories and Instruction Books online for all Panasonic Products by visiting our Web Site at:

<http://www.pasc.panasonic.com>

or, send your request by E-mail to:

npcparts@us.panasonic.com

You may also contact us directly at:

1-800-332-5368 (Phone) 1-800-237-9080 (Fax Only)

(Monday - Friday 9 am to 9 pm, EST.)

Panasonic Services Company

20421 84th Avenue South, Kent, WA 98032

(We Accept Visa, MasterCard, Discover Card, American Express, and Personal Checks)

TTY users (hearing or speech impaired users) can call 1-866-605-1277.

Service in Puerto Rico

Panasonic Puerto Rico, Inc.

San Gabriel Industrial Park, Ave. 65 de Infantería, Km. 9.5,

Carolina, Puerto Rico 00985

Phone (787)750-4300, Fax (787)768-2910

Warranty

PANASONIC CONSUMER
ELECTRONICS COMPANY, DIVISION
OF PANASONIC CORPORATION OF
NORTH AMERICA
One Panasonic Way,
Secaucus, New Jersey 07094

PANASONIC PUERTO RICO, INC.
San Gabriel Industrial Park,
Ave. 65 de Infantería, Km. 9.5,
Carolina, Puerto Rico 00985

Panasonic Telephone Products Limited Warranty

Limited Warranty Coverage

If your product does not work properly because of a defect in materials or workmanship, Panasonic Consumer Electronics Company or Panasonic Puerto Rico, Inc. (collectively referred to as “the warrantor”) will, for the length of the period indicated on the chart below, which starts with the date of original purchase (“Limited Warranty period”), at its option either (a) repair your product with new or refurbished parts, or (b) replace it with a new or a refurbished product. The decision to repair or replace will be made by the warrantor.

Parts

One (1) Year

Labor

One (1) Year

During the “Labor” Limited Warranty period there will be no charge for labor. During the “Parts” Limited Warranty period, there will be no charge for parts. You must mail-in your product prepaid during the Limited Warranty period. This Limited Warranty excludes both parts and labor for batteries, antennas, and cosmetic parts (cabinet). This Limited Warranty only applies to products purchased and serviced in the United States or Puerto Rico. This Limited Warranty is extended only to the original purchaser and only covers products purchased as new.

Mail-In Service

For assistance in the continental U.S.A. in obtaining repairs please ship the product prepaid to:

Panasonic Services Company Customer Servicenter

4900 George McVay Drive Suite B Door #12 McAllen, TX 78503

For assistance in Puerto Rico call Panasonic Puerto Rico, Inc. (787)-750-4300 or fax (787)-768-2910.

For Limited Warranty service for headsets if a headset is included with this product please call Panasonic Call Center at 1-800-211-PANA (1-800-211-7262).

When shipping the unit carefully pack, include all accessories, and send it prepaid, adequately insured and preferably in the original carton. Include a letter detailing the complaint and provide a day time phone number where you can be reached.

IF REPAIR IS NEEDED DURING THE LIMITED WARRANTY PERIOD THE PURCHASER WILL BE REQUIRED TO FURNISH A SALES RECEIPT/PROOF OF PURCHASE INDICATING DATE OF PURCHASE, AMOUNT PAID AND PLACE OF PURCHASE. CUSTOMER WILL BE CHARGED FOR THE REPAIR OF ANY UNIT RECEIVED WITHOUT SUCH PROOF OF PURCHASE.

Limited Warranty Limits And Exclusions

This Limited Warranty ONLY COVERS failures due to defects in materials or workmanship, and DOES NOT COVER normal wear and tear or cosmetic damage. The Limited Warranty ALSO DOES NOT COVER damages which occurred in shipment, or failures which are caused by products not supplied by the warrantor, or failures which result from accidents, misuse, abuse, neglect, bug infestation, mishandling, misapplication, alteration, faulty installation, set-up adjustments, misadjustment of consumer controls, improper maintenance, power line surge, lightning damage, modification, introduction of sand, humidity or liquids, commercial use such as hotel, office, restaurant, or other business or rental use of the product, or service by anyone other than a Factory Servicenter or other Authorized Servicer, or damage that is attributable to acts of God.

THERE ARE NO EXPRESS WARRANTIES EXCEPT AS LISTED UNDER "LIMITED WARRANTY COVERAGE". THE WARRANTOR IS NOT LIABLE FOR INCIDENTAL OR CONSEQUENTIAL DAMAGES RESULTING FROM THE USE OF THIS PRODUCT, OR ARISING OUT OF ANY BREACH OF THIS LIMITED WARRANTY. (As examples, this excludes damages for lost time, lost calls or messages, cost of having someone remove or re-install an installed unit if applicable, travel to and from the servicer. The items listed are not exclusive, but are for illustration only.) **ALL EXPRESS AND IMPLIED WARRANTIES, INCLUDING THE WARRANTY OF MERCHANTABILITY, ARE LIMITED TO THE PERIOD OF THE LIMITED WARRANTY.**

Some states do not allow the exclusion or limitation of incidental or consequential damages, or limitations on how long an implied warranty lasts, so the exclusions may not apply to you.

This Limited Warranty gives you specific legal rights and you may also have other rights which vary from state to state. If a problem with this product develops during or after the Limited Warranty period, you may contact your dealer or Servicenter. If the problem is not handled to your satisfaction, then write to the warrantor's Consumer Affairs Department at the addresses listed for the warrantor.

PARTS AND SERVICE, WHICH ARE NOT COVERED BY THIS LIMITED WARRANTY, ARE YOUR RESPONSIBILITY.

Index

- A** Answering calls: 23
 Answering system
 Erasing messages: 42, 43, 46
 Listening to messages: 42, 43
 Turning on/off: 40, 44, 46
 Auto talk: 23
- B** Battery
 Charge: 13
 Installation: 12
 Level: 13
 Performance: 14
 Replacement: 12
 Belt clip: 5, 55
 Booster (Clarity booster): 25
- C** Call screening: 40
 Call share: 26
 Call Waiting: 25
 Call Waiting Caller ID: 32
 Caller ID edit: 33
 Caller ID number auto edit: 34
 Caller ID service: 32
 Caller list
 Calling back: 33
 Editing: 33
 Erasing: 34
 Storing: 34
 Viewing: 33
 Chain dial: 30
 CID (Caller ID): 33
 Conference calls: 51
 Connections
 AC adaptor: 9, 12
 Noise filter: 11
 Telephone line cord: 10, 11
- D** Date and time: 19
 Deregistration: 54, 56
 Dialing mode: 19
- Display
 Contrast: 37
 Language: 19
- E** Error messages: 56
- F** Flash: 25
 Flash time: 39
- G** Greeting message: 41
- H** Handset locator: 49
 Headset, optional: 55
 Hold: 24
- I** Installation
 Base unit: 9
 Handset: 12
 Intercom: 49
 Interrupt tone: 37
- K** Key tone: 37
- L** Line selection: 20
- M** Making calls: 21
 MEMO: 44
 Memory capacity (message recording): 40
 Message alert: 48
 Missed calls: 32
 Mute: 25
- N** Navigator key: 16
- P** Pause: 28, 31
 Phonebook: 28
 Phonebook copy: 30
 Power failure: 9
 Privacy feature: 26
 Pulse service: 25
- R** Recording time: 47
 Redial list: 21
 Registration: 54
 Remote code: 48
 Remote operation: 45
 Ring count: 47
 Ringer off
 Base unit: 23
 Handset: 23, 38

Index

- Ringer tone
 - Base unit: 38
 - Handset: 38
- Room monitor: 53
- Rotary service: 25
- S** Speed dialer: 31
- SP-phone: 21, 22
- T** Toll saver: 47
- Tone service: 25
- Transferring calls: 50
- Troubleshooting: 58
- TTY: 5, 55, 66
- V** VE (Voice Enhancer): 26
- Voice guidance: 43, 45
- Volume
 - Base unit ringer: 23
 - Base unit speaker: 22
 - Handset receiver: 21
 - Handset ringer: 38
 - Handset speaker: 21
- W** Wall-mounting: 5, 55
- Charger: 14
- Warranty: 67

Notes

If you need assistance with setup or operation

- 1** Visit our website: <http://www.panasonic.com/phonehelp>
- 2** Contact us via the web at: <http://www.panasonic.com/contactinfo>
- 3** Call us at: 1-800-211-PANA (1-800-211-7262)
TTY users (hearing or speech impaired users) can call 1-877-833-8855.

When you ship the product

- Carefully pack your unit, preferably in the original carton.
- Attach a letter, detailing the symptom, to the outside of the carton.
- Send the unit to Panasonic Services Company Customer Servicer, prepaid and adequately insured.
- Do not send your unit to Panasonic Consumer Electronics Company listed below or to executive or regional sales offices. These locations do not repair consumer products.

**Panasonic Consumer Electronics Company,
Division of Panasonic Corporation of North America**
One Panasonic Way, Secaucus, New Jersey 07094

Panasonic Puerto Rico, Inc.
San Gabriel Industrial Park, Ave. 65 de Infantería, Km. 9.5,
Carolina, Puerto Rico 00985

Copyright:

This material is copyrighted by Panasonic Communications Co., Ltd., and may be reproduced for internal use only. All other reproduction, in whole or in part, is prohibited without the written consent of Panasonic Communications Co., Ltd.
© 2006 Panasonic Communications Co., Ltd. All Rights Reserved.



TG6700

PQQX15231YA DM0406PM1046

Free Manuals Download Website

<http://myh66.com>

<http://usermanuals.us>

<http://www.somanuals.com>

<http://www.4manuals.cc>

<http://www.manual-lib.com>

<http://www.404manual.com>

<http://www.luxmanual.com>

<http://aubethermostatmanual.com>

Golf course search by state

<http://golfingnear.com>

Email search by domain

<http://emailbydomain.com>

Auto manuals search

<http://auto.somanuals.com>

TV manuals search

<http://tv.somanuals.com>