

# Panasonic

Digital Answering System

Model No. **KX-TM150ALB**

## Operating Instructions



**DIGITAL**

Caller ID Compatibility

PLEASE READ BEFORE USE AND SAVE.

# Before Initial Use

**Thank you for purchasing your new Panasonic digital answering system.**

After subscribing to Caller ID Service from your telephone operator (where available), this unit will display a caller's phone number.

## For your future reference

Serial No. \_\_\_\_\_ Date of purchase \_\_\_\_\_  
(found on the bottom of the unit)

Name and address of dealer \_\_\_\_\_

Attach or keep original receipt to assist with any repair under warranty.

## Accessories (included)

AC Adaptor (p. 7)

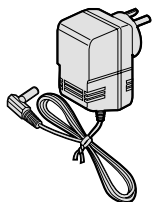

one

Telephone Line Cord (p. 7)

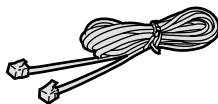

one

**For Australia only**

Telephone Plug (p. 7)

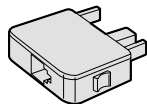

one

# Contents

- Location of Controls** . . . . . 4
- Display** . . . . . 5
- Settings** . . . . . 7
  - Connections . . . . . 7
  - Greeting Message . . . . . 8
  - Programming Summary . . . . . 10
  - Day and Time Adjustment . . . . . 11
  - Selecting the Number of Rings . . . . . 12
- Automatic Answering Operation** . . . . . 13
  - Setting the Unit to Answer Calls . . . . . 13
- Listening to Messages** . . . . . 15
- Erasing Messages** . . . . . 17
- Recording Your Telephone Conversation** . . . . . 18
- Caller ID Service** . . . . . 19
- Using the Caller List** . . . . . 20
  - Viewing the Caller List . . . . . 20
  - Calling Back from the Caller List . . . . . 22
  - Editing the Caller's Phone Number . . . . . 23
  - Erasing the Caller List Information . . . . . 24
- Remote Operation from a Touch Tone Phone** . . . . . 25
  - Setting the Remote Code . . . . . 25
  - Voice Menu . . . . . 26
  - Direct Remote Operation . . . . . 28
- Before Requesting Help** . . . . . 30
- Safety Instructions** . . . . . 32
- Important Information (For Australia only)** . . . . . 34

## Location of Controls

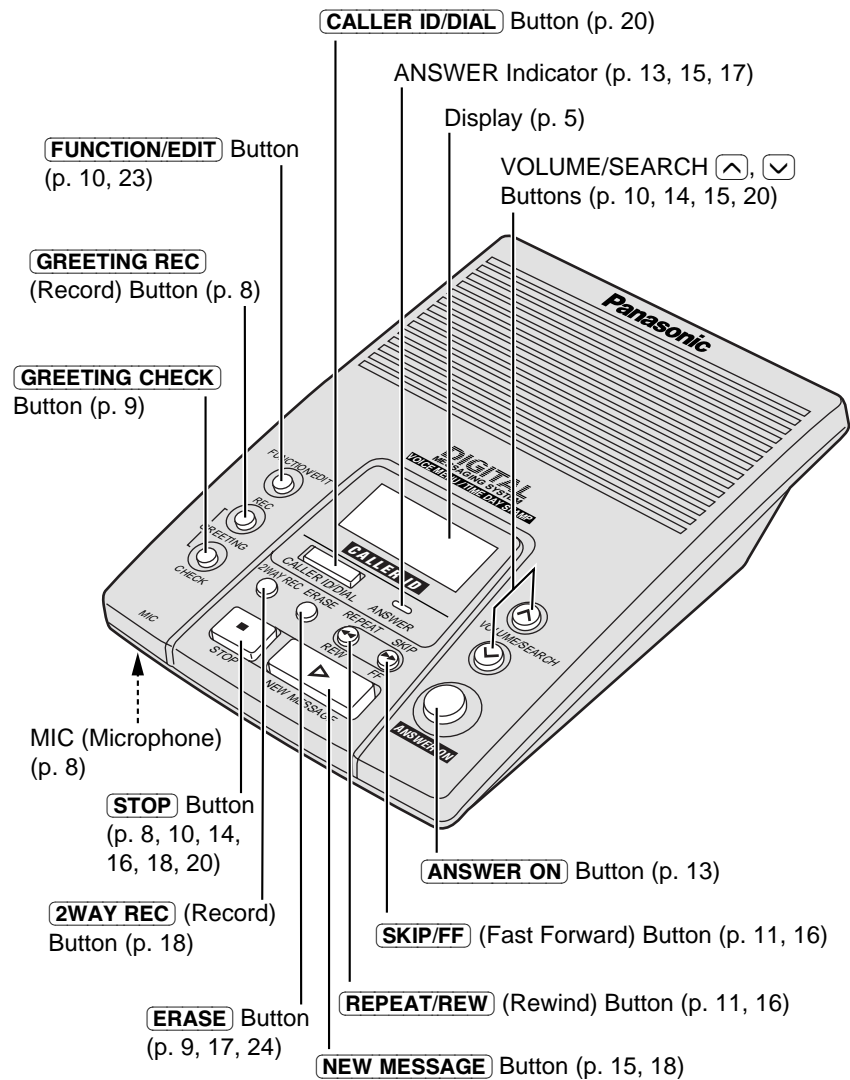

## Display

SUN 12:00AM  
5 new calls  
10 messages

In the stand-by mode, the display shows the current day and time, the number of new calls and recorded messages. (Ex. 5 new calls have been received and 10 messages have been recorded.)

SUN 12:00AM  
0 message

When the clock needs adjusting, the day and time flash (p. 11).

0211115555

When a call is received, the display shows the caller's phone number after the first ring.

012345678901234  
56789

When a call is received, the display shows the caller's phone number after the first ring.

0355667788  
11:20A JAN12 x3

This is an example of information from the Caller List.

The display shows:

- the caller's phone number,
- the time and date of the last call (Ex. Jan. 12, 11:20 AM), and
- the number of times called (Ex. 3 times).

5 new calls  
v=New    ^=Old

This display will be shown when **CALLER ID/DIAL** is pressed. To search from the most recent call, press **VOLUME/SEARCH**  $\surd$  (New key). To search from the oldest call, press **VOLUME/SEARCH**  $\wedge$  (Old key) (p. 20).

No items stored

The Caller List is empty.

## Display

Greeting record	Your greeting message or your telephone conversation was not recorded correctly.
Recording error	Record it again (p. 8, 18).
SUN 12:00AM 2way recording Recording error	
Greeting check	A greeting message is being played (p. 9). The display shows the elapsed time.
00-12	
0233334444	The answering system is recording a message (p. 13). ("- Answering -" flashes.)
- Answering -	
SUN 12:00AM 5 new calls Message full	Message memory is full. ("Message full" flashes.) Erase some, or all, of the messages (p. 17).
Ex. Volume level: 5	The display shows the volume level. You can select from 9 levels (0-8) (p. 14, 15).
Low ■■■■ High	

## Settings

### Connections

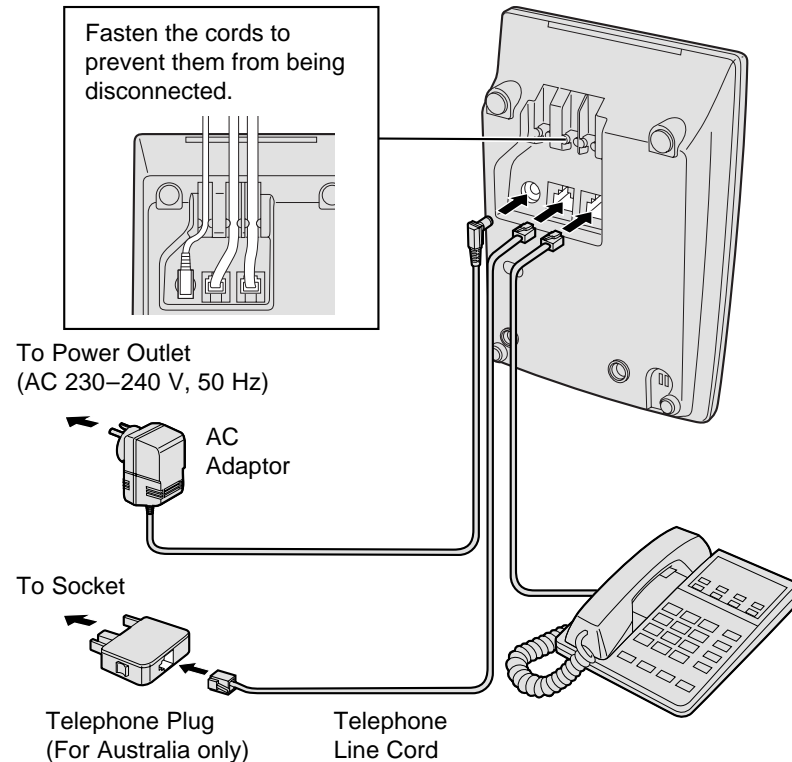

- USE ONLY WITH Panasonic AC ADAPTOR PQLV1AL.
- The AC adaptor must remain connected at all times. (It is normal for the adaptor to feel warm during use.)
- If your unit is connected to a PBX which does not support Caller ID services, you cannot access those services.
- KX-TM150ALB will not answer incoming calls on your FaxAbility number (New Zealand only).

## ▶ Settings

### Greeting Message

You can record a personal greeting message of **up to 2 minutes**. If a greeting message is not recorded, one of two pre-recorded greetings will be played when a call is received (p. 9).

All messages (greeting, incoming, etc.) are stored in digital memory (p. 9). The **total recording time is about 15 minutes**. We recommend you record a **brief greeting message** (see sample on next page) in order to leave more time for recording new messages.

#### To record a greeting message

**1** Press **[GREETING REC]** to start the recording mode.

- "Press RECORD again to record greeting" is heard.

SUN 12:00AM  
0 message

**2** Within 5 seconds, press **[GREETING REC]** again to record your greeting.

- A long beep sounds.

Greeting record  
00-00

**3** After the long beep, talk clearly, about 20 cm away from the **MIC** (microphone).

- The display shows the elapsed recording time.
- If you record for over 2 minutes, the unit will automatically stop recording.

Greeting record  
00-12

**4** When finished, press **[STOP]**.

- A beep sounds.
- To change the message, start again from step 1.

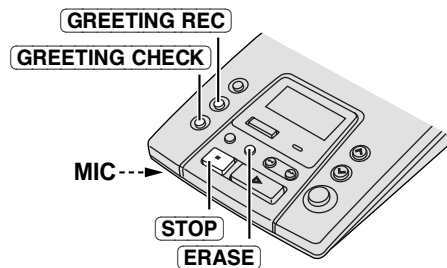

#### Greeting message sample

"Hello, this is (your name and/or number). Sorry I cannot take your call. Please leave a message after the beep. Thank you."

#### To check the greeting message

Press **[GREETING CHECK]**.

- The greeting is played back and the display shows the elapsed time.

#### To erase the recorded greeting message

Press **[GREETING CHECK]** ▶ **[ERASE]** while the message is being played.

- The unit will answer calls with a pre-recorded greeting.

#### Pre-recorded greeting message

If you do not record a greeting message (p. 8), one of two messages will be played when a call is received, depending on the remaining recording time.

To check the pre-recorded greeting, press **[GREETING CHECK]**.

- A pre-recorded greeting will be played as follows.

"Hello, we are not available now. Please leave your name and phone number after the beep. We will return your call."

When "Message full" is displayed:

"Hello, we are not available now. Please call again. Thank you for your call."

#### Flash Memory Message Backup

Messages are stored indefinitely on a "flash memory" IC chip and will not be affected by power failures. All messages are saved until you erase them.

## ▶ Settings

### Programming Summary

You can program the following functions. See the page numbers below for details.

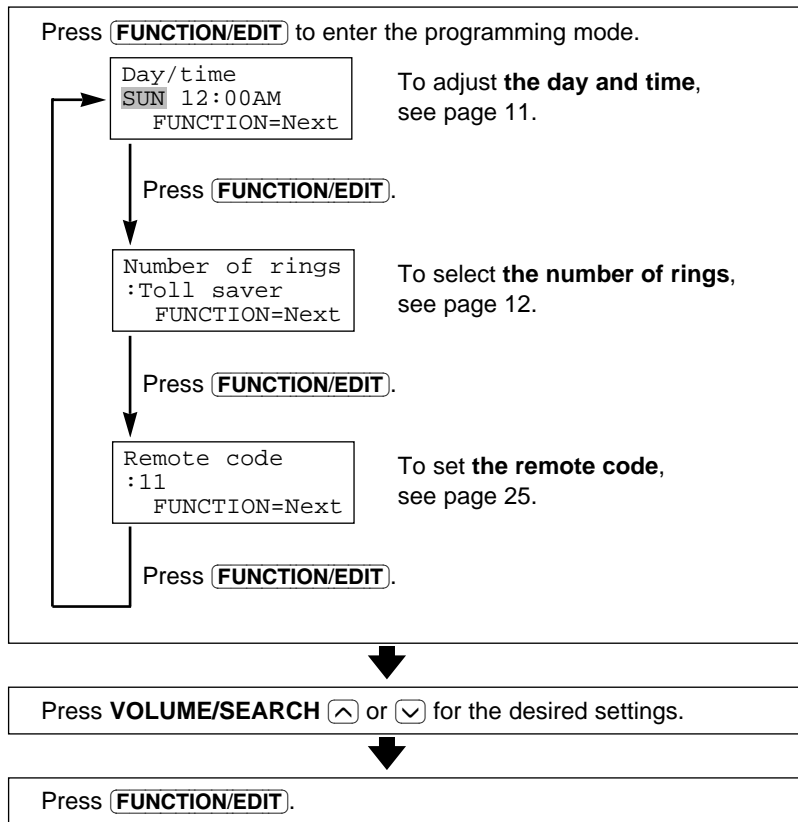

- You can exit the programming mode any time by pressing **STOP** or waiting for 60 seconds.

### Day and Time Adjustment

**Voice Day/Time Stamp:** During playback, a synthesised voice will announce the day and time that each message was recorded.

- Press **FUNCTION/EDIT** until "Day/time" is displayed.
  - The current setting is displayed.
- Press **SKIP/FF** or **REPEAT/REW** to move the cursor.
  - Each time you press **SKIP/FF**, the cursor moves in this order:  
**Day ▶ Hour ▶ Minute.**
- Press **VOLUME/SEARCH** (▲) or (▼) until the desired setting is displayed.
  - Each time you press the button, the display changes as follows.
    - Day:** Sun ▶ Mon ▶ Tue ▶ Wed ▶ Thu ▶ Fri ▶ Sat ▶ Sun
    - Hour:** 12AM ▶ 1AM ▶ ... ▶ 11AM ▶ 12PM ▶ ... ▶ 11PM ▶ 12AM
    - Minute:** 00 ▶ 01 ▶ ... ▶ 59 ▶ 00
- Press **FUNCTION/EDIT**.
  - A beep sounds and the clock starts working.
  - The display will return to the stand-by mode.

```
Day/time
SUN 12:00AM
FUNCTION=Next
```

```
Day/time
SUN 12:00AM
FUNCTION=Next
```

```
Day/time
SUN 1:00PM
FUNCTION=Save
```

```
Day/time
SUN 1:00PM
```

- To exit the programming mode, press **STOP** or wait for 60 seconds.

If a power failure occurs or the AC adaptor is disconnected for more than 10 minutes, the adjusted day/time will be erased.

#### For Caller ID service users (p. 19)

- The Caller ID information will re-set the clock after the first ring if the adjusted time is incorrect.
- The Caller ID information will automatically adjust the clock for daylight saving time.

## ▶ Settings



### Selecting the Number of Rings

You can select the number of times the unit rings before the answering system answers a call, from "2" to "7" or "Toll saver". Your unit comes from the factory set to "Toll saver".

**1** Press **FUNCTION/EDIT** until "Number of rings" is displayed.

- The current setting is displayed.

```
Number of rings
:Toll saver
FUNCTION=Next
```

**2** Press **VOLUME/SEARCH**  or  until the desired setting is displayed.

- 2-7:** The unit will answer after the selected number of rings.

**Toll saver:** Toll saver\* function is selected.

```
Number of rings
:2
FUNCTION=Save
```

**3** Press **FUNCTION/EDIT**.

- A beep sounds.
- The display will return to the stand-by mode.

```
Number of rings
:2
```

- To exit the programming mode, press **STOP** or wait for 60 seconds.

#### \*Toll saver

When you call the unit from a touch tone telephone:  
 If the unit answers on the 2nd ring, there is at least one new message.  
 If the unit answers on the 4th ring, there are no new messages.  
**Hang up when you hear the 3rd ring.** This will save you the toll charge for the call.

## Automatic Answering Operation ▶

When the unit answers a call, a greeting message is played and the caller's message is recorded. While recording, "- Answering -" will be displayed.

- The total recording time (including the greeting message and 2-way recording) is **about 15 minutes**. If messages are recorded in noisy rooms, the time may be shortened by up to 3 minutes.
- A maximum of 64 messages (including the greeting message and 2-way recording) can be recorded.
- The maximum recording time per caller is 3 minutes. If a caller records for over 3 minutes, the unit will announce "Thank you for your call" and the call will be disconnected.

### Setting the Unit to Answer Calls

Press **ANSWER ON** to turn on the answering system.

- The ANSWER indicator lights, and "Answer set" and the current day/time are heard.
- The unit will announce the remaining recording time if it is less than 5 minutes.
- If you hear "Memory full", "Message full" is displayed and the ANSWER indicator flashes rapidly, erase some, or all, of the messages (p. 17).

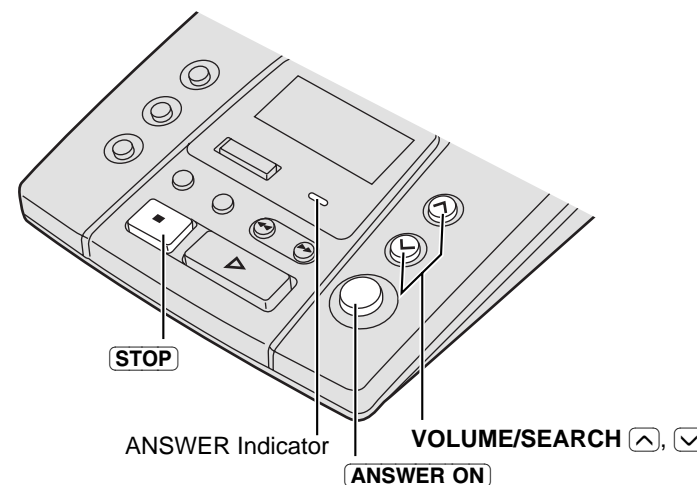



## ▶ Automatic Answering Operation

- If you do not want the unit to answer calls, press **ANSWER ON** again to turn off the answering system. The ANSWER indicator light goes out and "Answer off" is heard.
- You can also turn on the answering system remotely using any other phone (p. 29).

## Monitoring incoming calls

While a call is being recorded, you can monitor it through the speaker. To answer the call, lift the handset of the telephone connected to the same line. The unit stops recording.

- You can adjust the volume by pressing **VOLUME/SEARCH**  or .
- If the answering machine does not stop recording when you lift the handset, press **STOP**.
- KX-TM150ALB will not answer incoming calls on your FaxAbility number (New Zealand only).

## ▶ Listening to Messages

You can see the total number of recorded messages on the display. If the ANSWER indicator flashes, new messages have been recorded.

### Listening to only new messages

Press **NEW MESSAGE** briefly.



- The unit announces the number of new messages and plays them back.
- If there are no new messages, "No new messages" is heard.

### Listening to all recorded messages

Press and hold **NEW MESSAGE** until a short beep sounds.

- If there are no messages, "No messages" is heard.

### To adjust the speaker volume (9 levels):

While using the answering system, press **VOLUME/SEARCH**  or .

- The display shows the volume level.

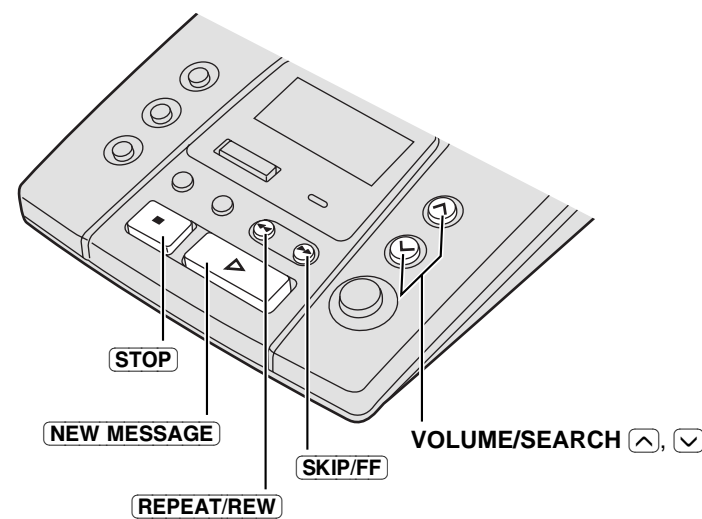



## ▶ Listening to Messages

- During playback, the display shows which message is being played. (Ex. While the first message is being played back, "Message 1" is displayed.)
- At the end of the last message, "End of final message" is heard. The unit will announce the remaining recording time if it is less than 5 minutes.
- All recorded messages are saved until you erase them.

### During playback

To repeat/ rewind message	<p><b>To repeat from the beginning of the message</b> Press <b>REPEAT/REW</b> briefly.</p> <ul style="list-style-type: none"> <li>• If you press within 5 seconds of playback, the previous message will be played.</li> </ul> <p><b>To rewind part of the message</b> Press and hold <b>REPEAT/REW</b> until you reach the desired place.</p> <ul style="list-style-type: none"> <li>• At the beginning of the message, 3 short beeps will sound.</li> </ul>
To skip/cue message	<p><b>To skip to the next message</b> Press <b>SKIP/FF</b> briefly.</p> <p><b>To cue to part of the message</b> Press and hold <b>SKIP/FF</b> until you reach the desired place.</p> <ul style="list-style-type: none"> <li>• The message will be heard at twice the normal speed.</li> <li>• At the end of the message, 3 short beeps will sound.</li> </ul>
To stop operation	<p>Press <b>STOP</b>.</p> <ul style="list-style-type: none"> <li>• To resume playback, press <b>NEW MESSAGE</b>.</li> <li>• If you do not press any button for 60 seconds or if you press <b>STOP</b> again, the unit will return to the stand-by mode.</li> </ul>

### For Caller ID service users (p. 19)

After listening to new incoming messages, "√" will be added to the call entries in the Caller ID Caller List (p. 21).

## Erasing Messages

The unit will announce the remaining recording time after playback, if it is less than 5 minutes. New messages cannot be recorded when:

- "Memory full" is heard.
- "Message full" is displayed.
- the ANSWER indicator flashes rapidly.

Erase some, or all, of the messages. We recommend you erase unnecessary messages after each playback.

### Erasing a specific message

Press **ERASE** while the message you want to erase is being played.

- The unit erases the message.
- A short beep will sound and the unit will continue to play the next message.

### Erasing all messages

All recorded messages, except the greeting message, can be erased at one time.

- 1 Press **ERASE**.
  - "Press ERASE again to erase all messages" is heard.
- 2 Within 5 seconds, press **ERASE** again.
  - A beep sounds and "No messages" is heard.
  - The display shows "0 message".
  - After the announcement, the display will return to the stand-by mode.

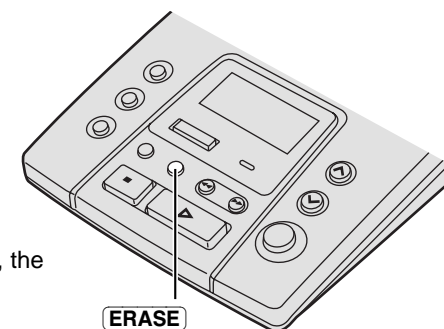

- The information in the Caller List will not be erased. To erase the Caller List information, see page 24.

## Recording Your Telephone Conversation

You can record your telephone conversation in memory. The recording time is only limited by the available memory.

- 1** During a conversation, press **2WAY REC**.

- A short beep sounds.

```
SUN 12:00AM
2way recording
00-00
```

- 2** Continue your conversation.

- "2way recording" and the elapsed recording time are displayed.

```
SUN 12:00AM
2way recording
00-27
```

- 3** When you finish recording the conversation, press **STOP** or **2WAY REC**.

- A beep sounds.
- The recorded conversation is stored as a new message. To listen, press **NEW MESSAGE** briefly (p. 15).

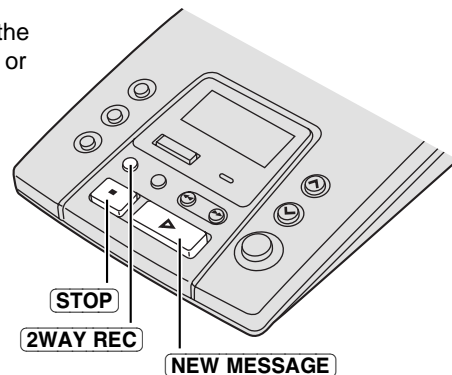

When you record your 2-way telephone conversation, you should inform the other party that the conversation is being recorded.

### For New Zealand Users Only

All persons using this device for recording telephone conversations shall comply with New Zealand law. This requires that at least one party to the conversation is to be aware that it is being recorded. In addition, the principles enumerated in the Privacy Act 1993 shall be complied with in respect to the nature of the personal information collected, the purpose for its collection, how it is to be used and what it disclosed to any other party.

## Caller ID Service

This unit is compatible with a Caller ID service offered by your telephone company. If you subscribe to a Caller ID service, the calling party's information will be displayed after the first ring.

The unit can record information of up to 50 different callers, including the time and date the call was received and the number of times called, in the Caller List. The Caller List information is sorted by the most recent to the oldest call. When the 51st call is received, the oldest call is deleted. Using the list, you can automatically call back a caller.

### How caller information is displayed when a call is received

The display shows the caller's phone number after the first ring.

If the phone number has 15 digits or less:	0211115555
If the phone number has 16 digits or more:	01234567890123456789

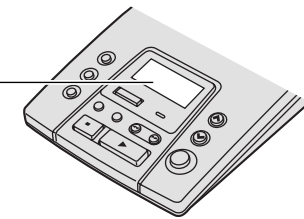

- Caller information cannot be displayed in the following cases:
  - If the caller dialed from an area which does not provide a Caller ID service, the display will show "Out of area".
  - If the caller has requested not to display his/her information, the display will show "Private caller".
- If your unit is connected to a PBX system which does not support Caller ID services, you cannot access those services.

### To check the number of new calls

You have received 5 new calls.

```
SUN 12:00AM
5 new calls
10 messages
```

You have received no new calls.

```
SUN 12:00AM
10 messages
```

# Using the Caller List

## Viewing the Caller List

To check who has called you, follow the steps below.

- 1 Press **CALLER ID/DIAL** to enter the list.
    - The number of new calls will be shown.

5 new calls  
 v=New      ^=Old
  - 2 To search from the most recent to oldest call, press **VOLUME/SEARCH**  (New key).  
 To search from the oldest to most recent call, press **VOLUME/SEARCH**  (Old key).
    - To move between callers, press **VOLUME/SEARCH**  or .
  - 3 To exit the list, press **STOP**.
    - The display will return to the stand-by mode.
- Once new calls have been checked, "√" will be added.
  - When you answer a call, it will be treated as new and "√" will not be added.
  - If "No items stored" is displayed in step 1, the Caller List is empty. Press **STOP** to exit the list.
  - If more than one call is received from the same caller, the date and time of the last call will be recorded. Also, when the same caller calls again, the call entry with "√" will be deleted.

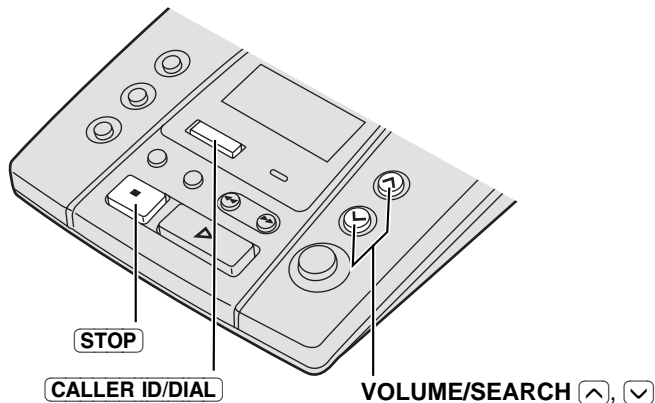

## Ex. When you search from the most recent call:

Press **CALLER ID/DIAL** to enter the list.

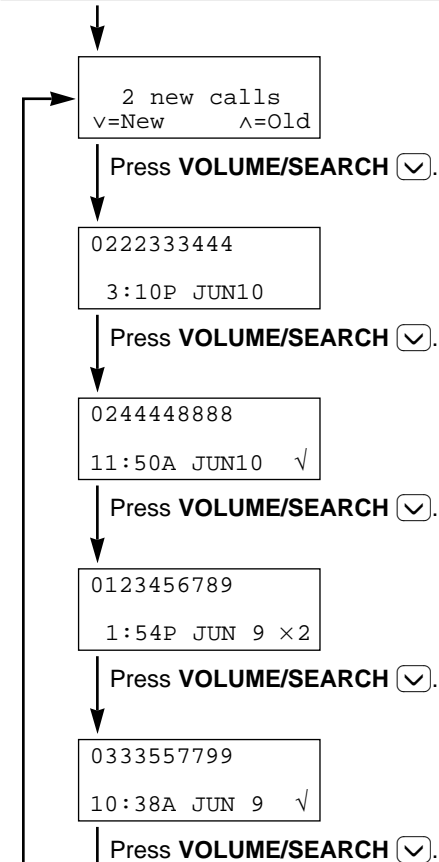

To return to the previous caller, press **VOLUME/SEARCH** .

To exit the Caller List, press **STOP**.  
 •The display will return to the stand-by mode.



### Display meaning:

- √ : You have checked this caller information, called back the caller or played back the message.
- ×2-×9 : The number of times they called (up to 9).  
 After checking, "×2" - "×9" will be replaced with "√".

## ▶ Using the Caller List

### Calling Back from the Caller List

- 1 Press **CALLER ID/DIAL** to enter the list.
 

5 new calls  
v=New      ^=Old
- 2 Press **VOLUME/SEARCH**  or  repeatedly to find the desired caller.
 

0234567890  
11:20A JAN12 ×3
- 3 Press **CALLER ID/DIAL**.
  - The displayed phone number is dialled automatically.



0234567890  
- Now dialing -
- 4 After dialling, two short beeps are heard and the display shows "Lift up the TEL handset and talk".
  - After 10 seconds, the display will return to the stand-by mode.

Lift up the TEL handset and talk
- 5 Lift the handset of the telephone connected to the same line and talk.
  - If you want to dial a number without the first two digits, press **EDIT** (p. 23).
  - If a phone number is not displayed in the caller information, you cannot call back that caller.
  - The phone number may not be dialled if you lift the handset before you press **CALLER ID/DIAL** or when "- Now dialing -" is being displayed.

### Editing the Caller's Phone Number

The unit can edit a phone number into one of 2 patterns.

- 1 Press **CALLER ID/DIAL** to enter the list.
 

5 new calls  
v=New      ^=Old
- 2 Press **VOLUME/SEARCH**  or  repeatedly to find the desired caller.
 

0276543210  
11:20A JAN12 ×3
- 3 Press **FUNCTION/EDIT** to select a pattern. Each time you press **FUNCTION/EDIT**, the pattern will change.
  - Ⓐ  -
  - Ⓑ

0276543210  
11:20A JAN12 ×3

76543210  
11:20A JAN12 ×3
- 4 After editing the number, you can continue with calling back procedures. To call back, press **CALLER ID/DIAL** (p. 22).

## ► Using the Caller List

### Erasing the Caller List Information

After checking the Caller List, you can erase some or all of the entries.

#### To erase a specific caller from the Caller List

- 1 Press **CALLER ID/DIAL** to enter the list.
 

5 new calls  
 v=New      ^=Old
- 2 Press **VOLUME/SEARCH**  or  repeatedly to find the caller you want to erase from the Caller List.
 

0355556666  
 12:20A JAN12 ✓
- 3 Press **ERASE**.
 

Clear

  - A beep sounds and the information is erased.
  - After a few seconds, the display will show the previous caller information.

#### To erase all entries in the Caller List

Before erasing all entries, make sure that "0 new call" is displayed.

- 1 Press **CALLER ID/DIAL** to enter the list.
 

0 new call  
 v=New      ^=Old
- 2 Press **ERASE**.
 

Press ERASE for all clear

  - A short beep sounds.
- 3 Press **ERASE** again.
 

All clear

  - A beep sounds and all entries are erased.
  - After a few seconds, the display will return to the stand-by mode.

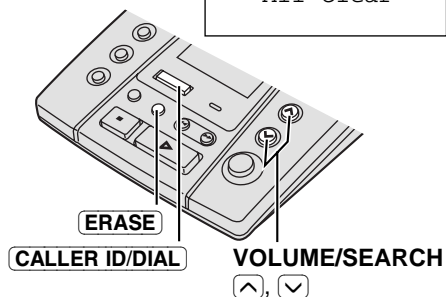

## Remote Operation from a Touch Tone Phone ►

You can operate the answering system from any touch tone phone. A synthesised voice menu will guide you on how to operate the unit (p. 26).

### Summary of remote operation

- 1 Call your unit from a touch tone phone.
  - The greeting message is played.
- 2 Enter your remote code during or after the greeting message. (See below.)
  - The number of new messages is heard.
- 3 After 3 seconds, the voice menu will start (p. 26). Follow the menu or enter the direct commands (p. 28, 29).
- 4 To end remote operation, hang up.
  - The messages are saved.

### Setting the Remote Code

The remote code prevents unauthorised people from accessing your unit and listening to your messages. Choose any **2-digit number (00–99)**. The factory preset remote code is "11". If you do not program your own remote code, you can use "11".

- 1 Press **FUNCTION/EDIT** until "Remote code" is displayed.
 

Remote code :11  
 FUNCTION=Next

    - The current remote code is displayed.
  - 2 Press **VOLUME/SEARCH**  or  until the desired code is displayed.
 

Remote code :23  
 FUNCTION=Save

    - If you want to clear the code, press **ERASE**.
  - 3 Press **FUNCTION/EDIT**.
 

Remote code :23

    - A beep sounds.
- To exit the programming mode, press **STOP** or wait for 60 seconds.

## Remote Operation from a Touch Tone Phone

### Voice Menu

The shaded boxes are voice prompts.

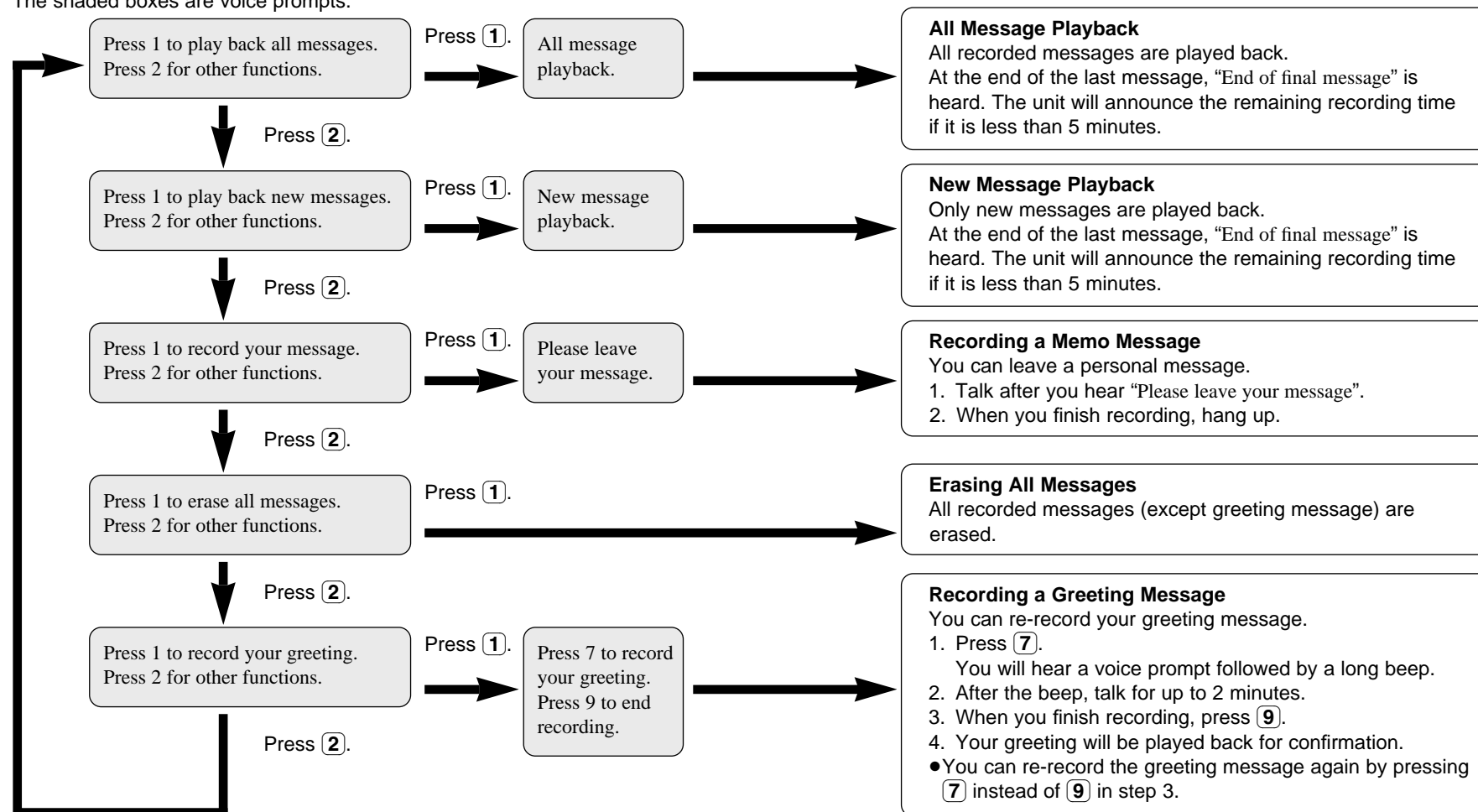

- 3 seconds after playback, the voice menu will start again from the beginning.
- If you hear "Memory full" after playback, erase some, or all, of the messages (p. 28).

## ► Remote Operation from a Touch Tone Phone

### Direct Remote Operation

Once you have entered the remote code, you can also control your unit by direct commands instead of using the voice menu. To end the remote operation, hang up anytime.

#### Direct commands

NEW MESSAGE PLAYBACK **4** • Only new messages are played back.

ALL MESSAGE PLAYBACK **5** • All messages are played back.

REPEAT (During playback) **1** • The current message is repeated.

SKIP (During playback) **2** • The current message is skipped. The next message is played.

STOP **9** • Operation is stopped temporarily.  
• To resume operation, enter a direct command within 15 seconds, or the voice menu will start.

GREETING MESSAGE RECORDING **7** • A long beep sounds.  
↓  
RECORD • After the beep, talk immediately for up to 2 minutes.  
↓  
**9** • The recording is stopped.  
• The recorded message is played.

ERASING A SPECIFIC MESSAGE (During playback) **\* 4** • The current message is erased.  
• A short beep will sound and the next message will be played.

ERASING ALL MESSAGES **\* 5** • All recorded messages are erased.  
• A beep sounds and "No messages" is heard.

ANSWERING SYSTEM OFF

**0**

• "Answer off" is heard. The unit hangs up and will not answer calls until turned on again.

### Turning on the answering system

Call your unit and wait for 15 rings.

- The unit will answer and the greeting message will be played.
- The answering system will turn on. Hang up or enter the remote code for other options.
- When turning on the answering system using a rotary or pulse service telephone, you cannot enter the remote code for other options.

### Skipping the greeting message

After calling your unit, press **\* 7** during the greeting message.

- The unit skips the rest of the greeting message and you can start recording your message after the long beep.

## Before Requesting Help

Problem	Remedy
The unit does not work.	<ul style="list-style-type: none"> <li>• Check the settings (p. 7–12).</li> <li>• Unplug the AC adaptor to reset. Plug in and try again.</li> </ul>
You cannot program function items, such as the dialling mode.	<ul style="list-style-type: none"> <li>• Do not pause for over 60 seconds while programming.</li> </ul>
While programming or searching, a telephone connected to the same line starts to ring and stops the program/search.	<ul style="list-style-type: none"> <li>• To answer the call, lift the handset. Start again from the beginning after hanging up.</li> </ul>
The unit does not display the caller's phone number whose message is being played.	<ul style="list-style-type: none"> <li>• If the caller is not stored in the Caller List, the unit will not display the caller's information.</li> </ul>
The display goes to the stand-by mode while viewing the Caller List.	<ul style="list-style-type: none"> <li>• Do not pause for over 60 seconds while searching.</li> </ul>
During message playback or monitoring a call, no sound is heard.	<ul style="list-style-type: none"> <li>• Press <b>VOLUME/SEARCH</b>  to increase volume.</li> </ul>
Previously programmed information is erased.	<ul style="list-style-type: none"> <li>• If a power failure occurs, programmed information may be erased. Reprogram if necessary.</li> </ul>
The answering system is on, but incoming messages are not recorded.	<ul style="list-style-type: none"> <li>• Memory is full. Erase some, or all, of the messages (p. 17).</li> </ul>
"Message full" is displayed, the ANSWER indicator flashes rapidly, and no new messages are recorded.	<ul style="list-style-type: none"> <li>• Memory is full. Erase some, or all, of the messages (p. 17).</li> </ul>

Problem	Remedy
You cannot operate the answering system from a touch tone phone.	<ul style="list-style-type: none"> <li>• Make sure to enter the correct remote code.</li> <li>• The answering system may not respond if the tones are too short to activate the unit. Press each button firmly.</li> <li>• The answering system is off. Turn it on (p. 29).</li> </ul>
While recording a greeting message, a telephone connected to the same line starts to ring and stops recording.	<ul style="list-style-type: none"> <li>• To answer the call, lift the handset. The recording will stop. Start again from the beginning after hanging up.</li> </ul>
During playback, a telephone connected to the same line starts to ring and stops playback.	<ul style="list-style-type: none"> <li>• To answer the call, lift the handset. To resume playback, press <b>NEW MESSAGE</b> after hanging up.</li> </ul>



# Safety Instructions

Take special care to follow the safety suggestions listed below.

## Safety

- 1) The unit should be connected to a power supply only of the type described in the operating instructions or as marked on the unit.
- 2) When left unused for a long period of time, the unit should be unplugged from the household AC outlet.
- 3) To minimize the possibility of lightning damage when you know that a thunderstorm is coming, we recommend that you:
  - a) Unplug the telephone line cord from the phone jack.
  - b) Unplug the power supply cord from the AC power outlet.

## Installations

### Environment

- 1) Do not use this unit near water—for example, near a bathtub, washbowl, sink, etc. Damp basements should also be avoided.
- 2) The unit should be kept away from heat sources such as radiators, kitchen range, etc. It also should not be placed in rooms where the temperature is less than 5°C or greater than 40°C.

### Placement

- 1) Do not place heavy objects on top of this unit.
- 2) Care should be taken so that objects do not fall onto, and liquids are not spilled into, the unit. Do not subject this unit to excessive smoke, dust, mechanical vibration or shock.
- 3) Place the unit on a flat surface.

### WARNING:

TO PREVENT FIRE OR SHOCK HAZARD, DO NOT EXPOSE THIS PRODUCT TO RAIN OR ANY TYPE OF MOISTURE.

When a failure occurs which results in the internal parts becoming accessible, disconnect AC adaptor immediately and return this unit to the place of purchase or service centre.

If there is any trouble, disconnect the unit from the telephone line and connect a known working phone. If the known working phone operates properly, do not reconnect the unit to the telephone line until the trouble has been repaired. If the known working phone does not operate properly, consult with your telephone company.

This equipment has been tested and found to comply with AS/NZS 3548: 1995 limits for electromagnetic interference. Any modifications to any part of the system or to any peripherals may void the EMC compliance of the system or the peripherals.

### WARNING:

This equipment will be inoperable if mains power fails.

### For New Zealand Users Only

The grant of a Telepermit for any item of terminal equipment indicates only that Telecom has accepted that the item complies with minimum conditions for connection to its network. It indicates no endorsement of the product by Telecom, nor does it provide any sort of warranty. Above all, it provides no assurance that any item will work correctly in all respects with another item of Telepermitted equipment of a different make or model, nor does it imply that any product is compatible with all of Telecom's network services.

This device only responds to Distinctive Alert cadence(s) DA1 & DA3.

## Important Information (For Australia only)

### Instructions to customer

#### Installation

Attached to this apparatus is an approval label. This label is evidence that it is a "Permitted Attachment" which has been authorised to be connected to your telephone service.

Conditions relating to connection and operation of this Permitted Attachment are contained in Telecommunications General By-Law 220 (5).

You are authorised to install this Permitted Attachment yourself by plugging it into the line socket of any regular telephone. You may connect it in place of your existing telephone or to any spare telephone socket installed in your premises.

To disconnect your existing telephone you must first remove its plug from the line socket. You can then insert the plug of your Permitted Attachment into the socket and use your equipment.

If the plug of your existing telephone cannot be readily removed, you will have to remove the screw securing it. To do this proceed as follows:

1. Loosen screw "A" sufficiently to remove the socket cover. (See Fig. 1.)
2. Remove screw "B" and withdraw the plug. (See Fig. 2.)
3. Replace screw "B". (See Fig. 3.) Ensure that it screws completely into the socket recess. (If the screw is too long, increase the hole depth or replace the screw with one 5 mm shorter.)
4. Replace socket cover and tighten screw "A". (See Fig. 4.)

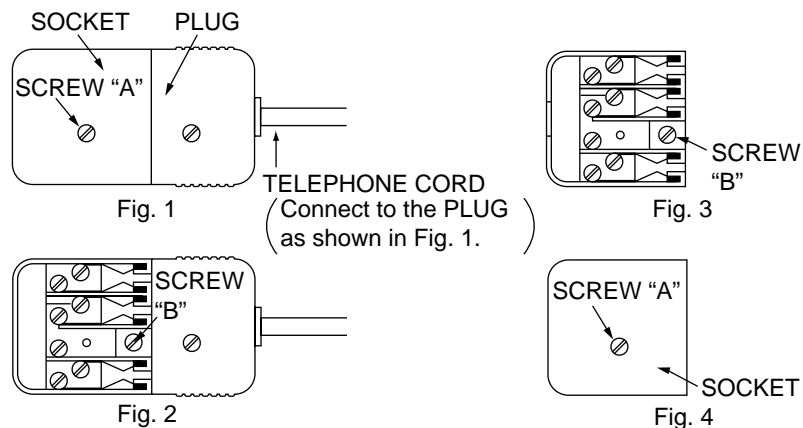

If you are satisfied with the operation of your telephone service after plugging in your Permitted Attachment, your installation is completed.

You will be unable to connect this Permitted Attachment if your telephone service consists only of a wall phone or an old style telephone which is not connected by means of a modern plug and socket. In such cases a new socket will need to be installed.

Should the Permitted Attachment not operate when plugged into a socket, it is either faulty or unsuitable for operation with your telephone service. It should be returned to the store where purchased.

#### Service difficulties

If at any time a fault occurs on your telephone service carry out the following checks before you call for service:

- Disconnect the Permitted Attachment and try using the service with the normal telephone.
- If the telephone service then operates satisfactorily, the fault is in your Permitted Attachment. Leave the Permitted Attachment disconnected and report the fault to its supplier or agent to arrange for repair.
- If when using the telephone the service is still faulty, report the fault to "Service Difficulties and Faults" for attention.

You are required to keep this Permitted Attachment in good working order while it is connected to your telephone service. Its construction or internal circuit must not be modified in any way without permission.

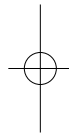
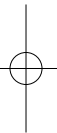

**Kyushu Matsushita Electric Co., Ltd.**

1-62, 4-chome, Minoshima, Hakata-ku, Fukuoka 812-8531, Japan

Printed in Malaysia

**PQQX12356ZA-BM** FM0899SA0 ©

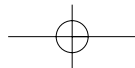

## Free Manuals Download Website

<http://myh66.com>

<http://usermanuals.us>

<http://www.somanuals.com>

<http://www.4manuals.cc>

<http://www.manual-lib.com>

<http://www.404manual.com>

<http://www.luxmanual.com>

<http://aubethermostatmanual.com>

Golf course search by state

<http://golfingnear.com>

Email search by domain

<http://emailbydomain.com>

Auto manuals search

<http://auto.somanuals.com>

TV manuals search

<http://tv.somanuals.com>