

Panasonic®

2.4GHz Digital Cordless Answering System

Operating Instructions

Model No. **KX-TG2323C**

Pulse-or-tone dialing capability



PLEASE READ BEFORE USE AND SAVE.

Charge the battery for 6 hours before initial use.

For assistance, please call 1-800-561-5505 or visit us at www.panasonic.ca

Thank you for purchasing your new Panasonic cordless telephone.

Accessories (included)

AC Adaptor (p. 9)

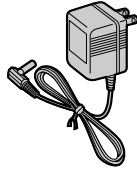

one

Telephone Line Cord (p. 9)

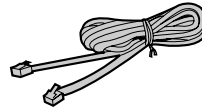

one

Battery (p. 10)

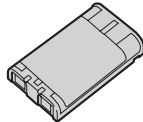

one

Handset Cover (p. 10)

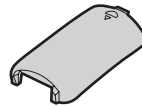

one

Belt Clip (p. 32)



one

Shoulder Rest Attachment (p. 32)



one

For Best Performance

Battery Charge

The handset is powered by a rechargeable Nickel-Metal Hydride (Ni-MH) battery. Charge the battery for **6 hours** before initial use (p. 10).



Base Unit Location/Noise

Calls are transmitted between the base unit and handset using wireless radio waves. **For maximum distance and noise-free operation**, the recommended base unit location is:

Away from electrical appliances such as a TV, personal computer or another cordless phone.

In a HIGH and CENTRAL location with no obstructions such as walls.

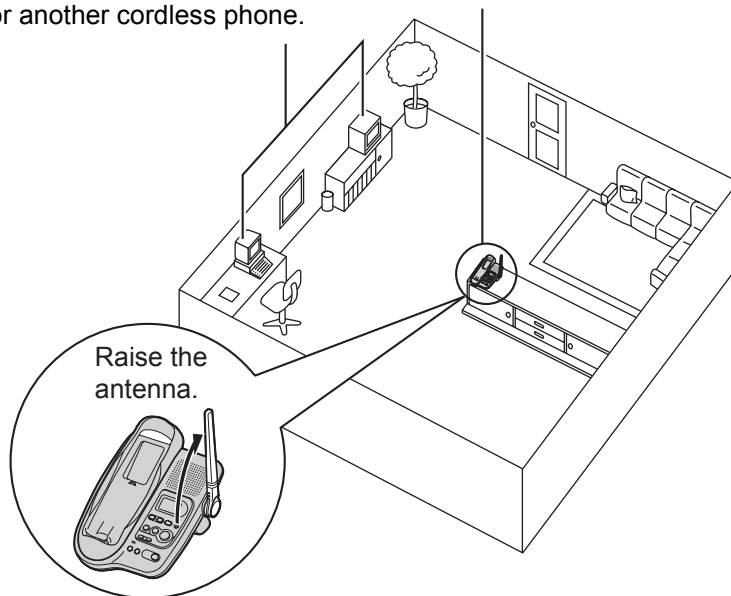

Note:

- If you use the handset near a microwave oven which is being used, noise may be heard from the receiver or the speaker. Move away from the microwave oven and closer to the base unit.
- If you use the handset near another cordless phone's base unit, noise may be heard. Move away from the other cordless phone's base unit and closer to your base unit.

Contents

Preparation

Location of Controls	6
Installation	9
Connections	9
Installing the Battery in the Handset	10
Battery Charge	10
Programmable Settings	12
Programmable Functions	12
Voice Guidance Language	13
Time and Day	13
Dialing Mode	14
Ringer Volume	15
Ringer Tone	15
Preparing the Answering System	16
Greeting Message	16
Number of Rings	18
Remote Code	18

Telephone System

Making Calls	19
Answering Calls	21
Special Features	22
Handset Locator	22
Temporary Tone Dialing (For Rotary or Pulse Service Users) ...	22
For Call Waiting Service Users	22
FLASH Button	22
Re-registering the Handset	23

Contents

Answering System

Automatic Answering Operation	24
Setting the Unit to Answer Calls	24
Monitoring Incoming Calls	25
Listening to Messages	26
Erasing Messages	27
Remote Operation from a Touch Tone Phone	28
Voice Menu	29
Direct Remote Operation	30

Useful Information

Wall Mounting	31
Belt Clip	32
Shoulder Rest Attachment	32
Optional Headset	33
Troubleshooting	34
Important Information	37
Safety Instructions	38
Specifications	39
Warranty	Back Cover

Important:

Throughout these Operating Instructions, **Handset** and **Base Unit** are used to indicate with which unit an operation can be performed.

Handset : Perform with the handset.

Base Unit : Perform with the base unit.

Handset & Base Unit : Perform with the handset and base unit together.

Preparation

Telephone System

Answering System

Useful Information

Location of Controls

Handset

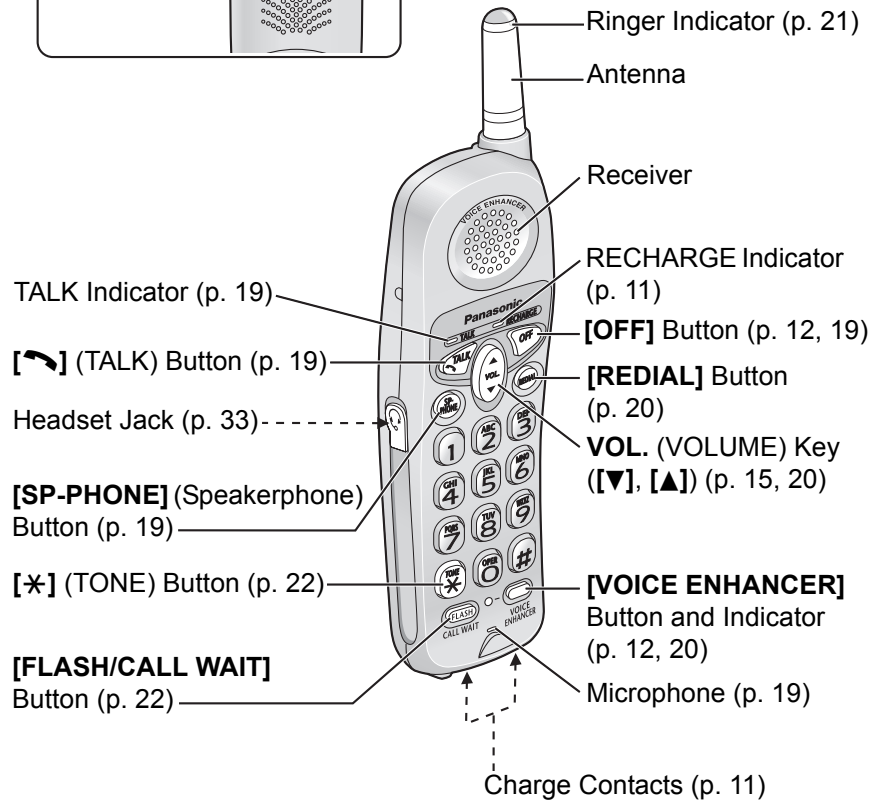
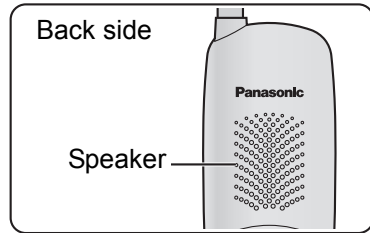

Location of Controls

Base unit

Preparation

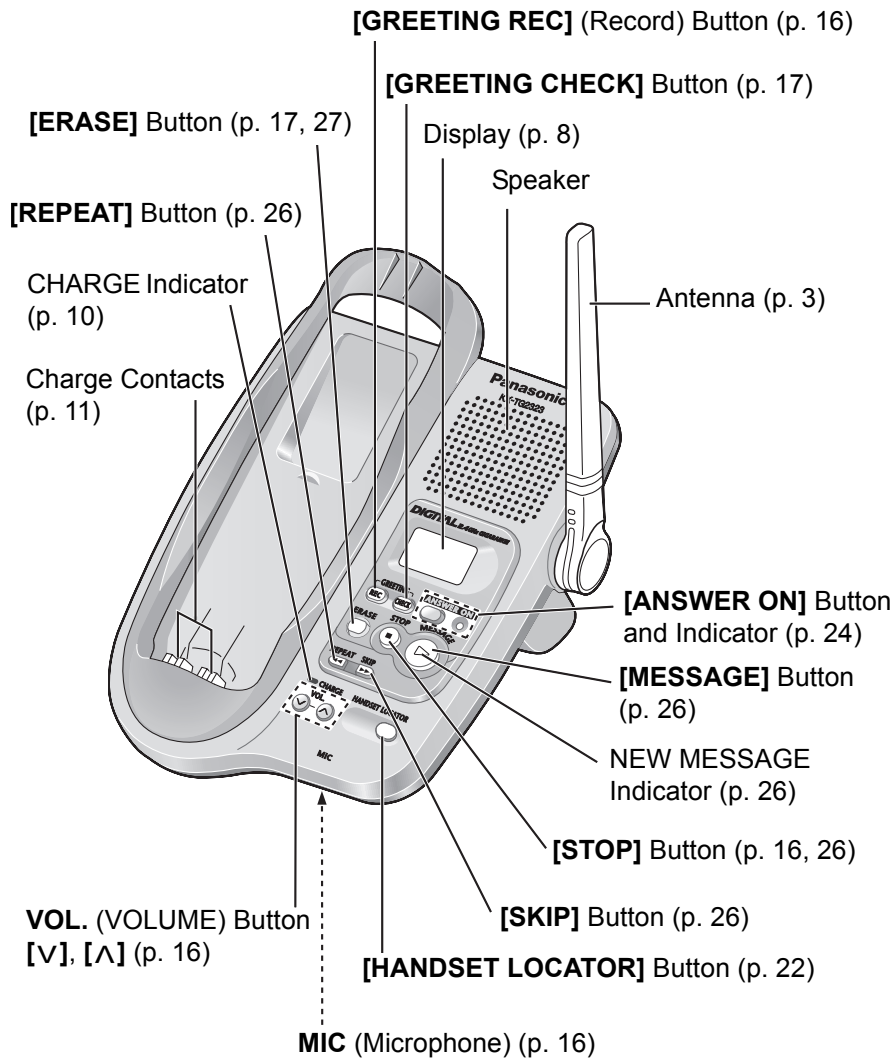

Location of Controls

Base unit display

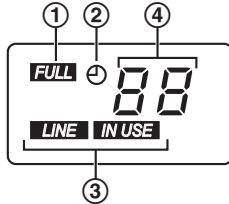

① “**FULL**” flashes when no new messages can be recorded. Erase unnecessary messages (p. 27).

② “**⊕**” flashes until you set the time and day, and flashes after a power failure. If it is flashing, set the time and day (p. 13).

③ “**LINE IN USE**” functions as follows.

Off (invisible)	The line is free.
On	The line is being used.
Flashing	Answering System is answering a call (p. 24).
Flashing rapidly	A call is being received.

④ Message counter shows:

- the total number of recorded messages (p. 26).
- the selected volume level while you are adjusting the speaker volume (p. 16).
- “**E**” when your greeting message was not recorded correctly (p. 16).
- “**P**” during programming (p. 12).
- “**R**” when [**0**] is pressed for Toll Saver mode when selecting the number of rings (p. 18).

Installation

Connections

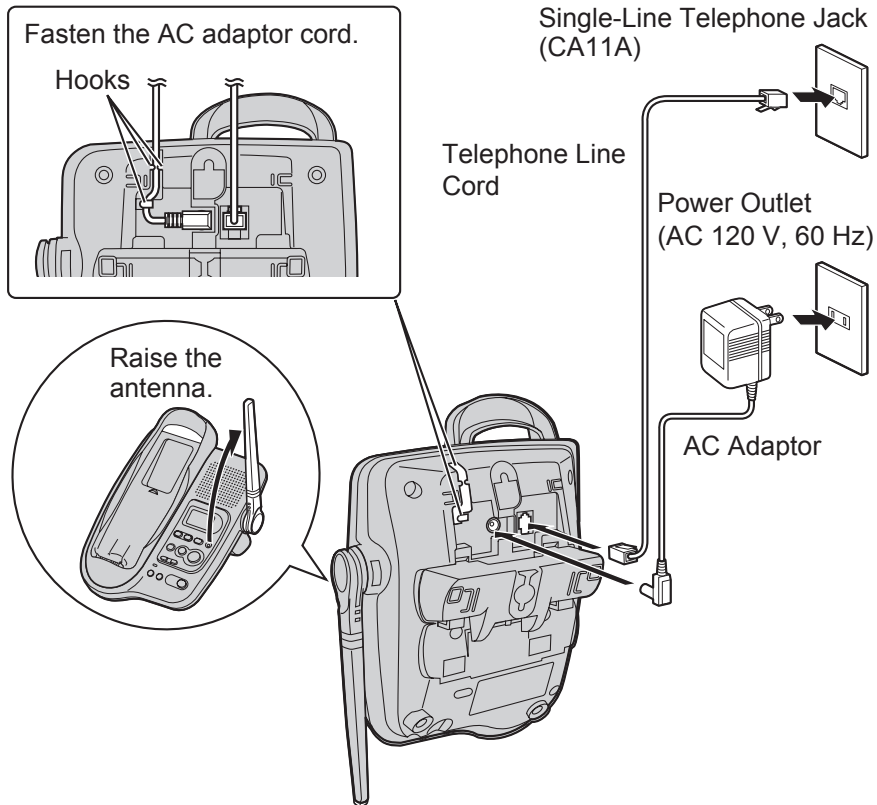

- USE ONLY WITH Panasonic AC ADAPTOR PQLV1.
- The AC adaptor must remain connected at all times. (It is normal for the adaptor to feel warm during use.)
- The unit will not work during a power failure. We recommend connecting a standard telephone to the same telephone line or to the same telephone jack using a T-adaptor.

Installation

Installing the Battery in the Handset

Insert the battery (①), and press it down until it snaps into the compartment (②). Close the cover.

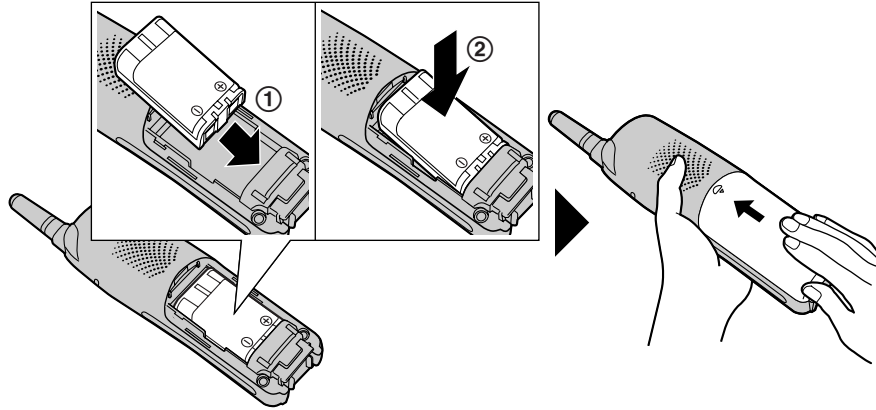

To replace the battery:

Press the notch on the cover firmly and slide it as indicated by the arrow. Replace the old battery with a new one (p. 11). Close the cover and charge the battery for 6 hours.

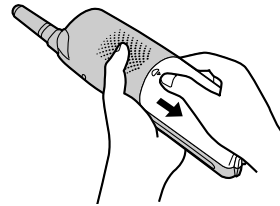

Battery Charge

Place the handset on the base unit. Charge for **6 hours** before initial use. Repeat charging will require approximately the same amount of charging time (6 hours) if the battery is depleted completely.

- The unit beeps once and the CHARGE indicator lights.

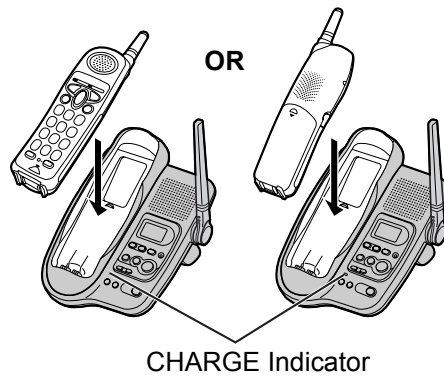

Installation

Recharge

- Recharge the battery when:
- the RECHARGE indicator flashes, or
 - the handset beeps intermittently while it is in use.
- The RECHARGE indicator will flash when the handset battery is charged for less than 15 minutes and the handset is lifted off the base unit.

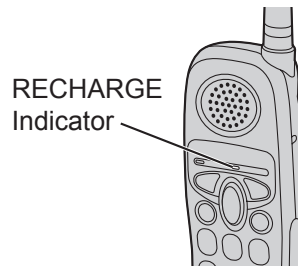

Battery replacement:

If you cleaned the charge contacts and fully charged the battery, but after a few telephone calls, the RECHARGE indicator flashes, the battery may need to be replaced. Please replace with a new Panasonic HHR-P104 battery. To replace the battery, see page 10.

A nickel metal hydride battery that is recyclable powers the product you have purchased. Please call 1-800-8-BATTERY for information on how to recycle this battery.



Battery information

After your Panasonic battery is fully charged, you can expect the following performance:

Operation	Operating time
While in use (TALK)	Up to 5 hours
While not in use (Standby)	Up to 11 days

- A fully charged battery will give you up to 5 hours of continuous talk time, or keep your handset in Standby mode to receive incoming calls for up to 11 days (if no phone calls are made). Battery power is consumed whenever the handset is off of the base unit, even when the handset is not in use. The longer you leave the handset off of the base unit, the time you can actually talk on the handset will be shortened. Actual battery performance depends on a combination of how often the handset is in TALK mode and how often it is in Standby mode.
- **Clean the charge contacts of the handset and the base unit with a soft, dry cloth once a month. Clean more often if the unit is subject to grease, dust or high humidity,** otherwise the battery may not charge properly.
- If the battery is fully charged, you do not have to place the handset on the base unit until the RECHARGE indicator flashes. This will maximize the battery life.
- If you want to keep the battery fully charged at all times, place the handset on the base unit when the handset is not used. The battery cannot be overcharged.

Programmable Settings

Programmable Functions **Handset**

You can use the following functions to customize your unit. See the corresponding pages for function details.

Make sure the handset and base unit are not being used. The handset must be operated near the base unit and while off the base unit.

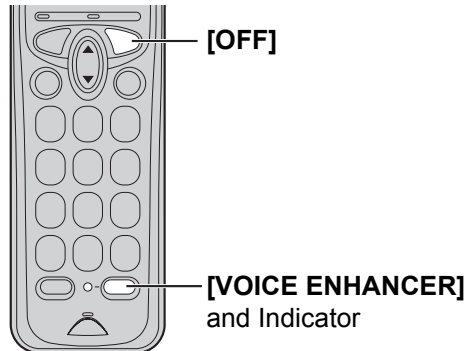

Lift the handset, then press **[VOICE ENHANCER]**.

- The indicator flashes.
- “P” is displayed on the base unit.

To set **the time and day**, press **[0]**. (See page 13.)

To set **the remote code**, press **[1]**. (See page 18.)

To select **the number of rings**, press **[2]**. (See page 18.)

To select **the dialing mode**, press **[8]**. (See page 14.)

To select **the voice guidance language**, press **[*]**. (See page 13.)

- The display shows numbers or characters related to adjustments or settings.

Press **[VOICE ENHANCER]**.

- A confirmation tone will be heard and the setting will be saved.
- The indicator light goes out.

- If an alarm tone sounds during programming, walk closer to the base unit and try again from the beginning.
- You can exit programming mode at any time by pressing **[OFF]**.
- If you do not press any buttons for 60 seconds, the handset will exit programming mode.

Programmable Settings

Voice Guidance Language **Handset**

You can select either “English” or “French” as the voice guidance language. The factory preset is “English”.

- 1** Press **[VOICE ENHANCER]**.
 - The indicator flashes.
- 2** Press **[*]**.
 - The current setting is displayed on the base unit.
1: English 2: French
- 3** To select English, press **[1]**.
To select French, press **[2]**.
 - The voice guidance language changes to the selected language.
- 4** Press **[VOICE ENHANCER]**.
 - The handset beeps and the indicator light goes out.

Preparation

Time and Day **Handset**

We recommend that you set the time and day so that the unit will announce the day and time each message was recorded when you play back messages.

- 1** Press **[VOICE ENHANCER]**.
 - The indicator flashes.
- 2** Press **[0]**.
 - “Set time” is announced. If previously set, the day and time will be announced.
- 3** Enter 4 digits for the time (hour and minute).
(e.g. To set 9:30, enter “0930”.)
- 4** Set the AM or PM by pressing **[*]**.
 - Each time you press **[*]**, “AM” or “PM” will be announced.
- 5** Set the day by pressing **[#]**.
 - Each time you press **[#]**, the selected day will be announced.
- 6** Press **[VOICE ENHANCER]**.
 - The unit announces the day and time, the clock is set and “Ⓢ” disappears from the base unit display.
 - The handset beeps and the indicator light goes out.
 - If the handset beeps 3 times, the time was not set correctly. Try again from step 1.

Programmable Settings

- When entering the time in step 3, you cannot enter numbers greater than 12. **Do not use military time.** (To set 13:00 hours, enter "0100", then select PM in step 4.)
- When the voice guidance language is set to French, you can use military time (see page 13 of the French Operating Instructions).

The time and day may be incorrect after a power failure. When "⊖" flashes on the display, set the time and day again.

To confirm the time and day, press [VOICE ENHANCER] then [0].

- The current day and time are announced. When finished, press [OFF].

Dialing Mode **Handset**

If you have touch tone service, set the dialing mode to "Tone". For rotary or pulse service, set to "Pulse". The factory preset is "Tone".

1 Press [VOICE ENHANCER].

- The indicator flashes.

2 Press [8].

- The current setting is displayed on the base unit.
1: Pulse 2: Tone

**3 To select "Pulse", press [1].
To select "Tone", press [2].**

4 Press [VOICE ENHANCER].

- The handset beeps and the indicator light goes out.

Programmable Settings

Ringer Volume **Handset**

You can set the handset ringer volume to high, medium, low, or off. The factory preset is HIGH. If the handset ringer is turned off, the handset will not ring.

To set the ringer volume to high (preset), medium or low, press [▼] or [▲].

- To increase volume, press [▲]. To decrease volume, press [▼].
- To stop ringing, press [OFF] or [VOICE ENHANCER].

To turn the ringer off, press and hold [▼] until 2 beeps sound.

To turn the ringer on, press [▼] or [▲].

- The handset will ring at the low level.
- The VOICE ENHANCER indicator flashes while you are adjusting the ringer volume.
- You can adjust the ringer volume while a call is ringing. Press [▼] or [▲] while the handset is ringing. To turn the ringer off, press and hold [▼] until 2 beeps sound.

Preparation

Temporary ringer off

While the handset is ringing for an outside call, you can turn the ringer off temporarily by pressing [OFF]. The handset will ring again as usual the next time a call is received.

Ringer Tone **Handset**

You can select the handset ringer to use one of 7 ringer patterns. There are 3 bell ringer patterns and 4 melody patterns available. The factory preset is "Bell ringer pattern 1".

- If you subscribe to a Distinctive Ring Service from your telephone company with 2 or 3 consecutive rings, select a bell ringer pattern (Tone 1 to 3). If you select a melody pattern, you will not be able to distinguish lines by their ringers.
- If you select one of the melody ringer patterns, the ringer will continue to sound for several seconds if:
 - the caller hangs up before you answer the call, or
 - another person answers the call using another phone connected on the same line.

Press [▼] or [▲], then select the desired tone by pressing [1] to [7].

[1] to [3]: Bell ringer patterns [4] to [7]: Melody patterns

- After pressing [▼] or [▲], the handset will ring using the current ringer tone.
- The handset will ring and the ringer tone will change.
- The VOICE ENHANCER indicator flashes while you are selecting a ringer tone.
- To stop ringing, press [OFF] or [VOICE ENHANCER].

Preparing the Answering System

Greeting Message **Base Unit**

You can record a personal greeting message of **up to 2 minutes**. If you do not record your own message, a pre-recorded greeting will be played for callers (p. 17).

The total recording time of all messages (greeting and incoming) is **about 10 minutes**.

We recommend that you record a **brief greeting message** in order to leave more time for recording new messages.

To record a greeting message

Sample greeting message

“Hello, this is (your name and/or number). Sorry, I cannot take your call. Please leave a message after the beep. Thank you.”

- 1** Press **[GREETING REC]**.
 - “To record greeting, press RECORD again” is heard.
- 2** Within 10 seconds, press **[GREETING REC]** again to record your greeting.
- 3** After the long beep, speak clearly, about 20 cm (8 inches) away from the **MIC** (microphone).
 - The elapsed recording time is displayed.
 - If you record for over 2 minutes, the unit will stop recording.
- 4** When finished, press **[GREETING REC]** or **[STOP]**.
 - To change the greeting, try again from step 1.

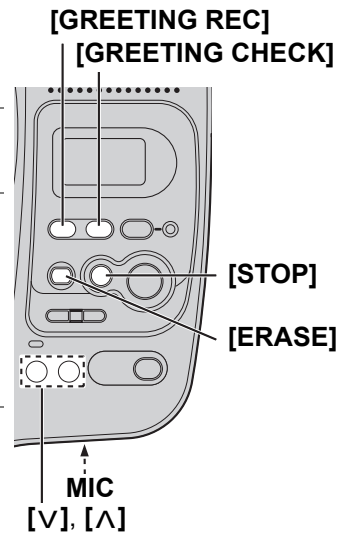

- If “E” is displayed, 6 beeps sound and “Your greeting was not recorded. Record your greeting again.” is announced, try again from step 1.

To adjust the speaker volume, press **[V]** or **[^]** during playback.

- 9 levels (0–8) are available while using the Answering System. The level is displayed on the base unit.

Preparing the Answering System

To review the greeting

Press **[GREETING CHECK]**.

To erase the greeting

Press **[GREETING CHECK]**, then press **[ERASE]** while the recorded message is being played.

- The unit will answer calls with a pre-recorded greeting (see below).

Pre-recorded greeting

If you do not record a greeting (p. 16), a pre-recorded greeting will be played when a call is received.

To review the pre-recorded greeting, press **[GREETING CHECK]**.

- A pre-recorded greeting will be played as follows:

“Hello, we are not available now. Please leave your name and phone number after the beep. We will return your call.”

- If recording time runs out, the unit will automatically announce:

“Hello, we are not available now. Please call again. Thank you for your call.” Then the unit hangs up. The unit will not record any incoming messages.

Flash Memory Message Backup (Message storage)

Messages stored in memory will not be affected by power failures. All messages are saved until you erase them.

Preparation

Preparing the Answering System

Number of Rings **Handset**

You can select the number of times the unit rings before the Answering System answers a call, from “2” to “7” or “Toll saver”*. The factory preset is “4”.

- 1** Press **[VOICE ENHANCER]**.
 - The indicator flashes.
- 2** Press **[2]**.
 - The current setting is displayed on the base unit.
- 3** Select the number of rings by pressing **[0]** (Toll saver*), or **[2]** to **[7]**.
 - If **[0]** (Toll saver) is pressed, “**R**” is displayed.
- 4** Press **[VOICE ENHANCER]**.
 - The handset beeps and the indicator light goes out.

*Toll saver

When you call the unit from a remote operation, the number of rings will tell you if there are any new messages. If the unit answers on the 2nd ring, there is at least one new message. If the unit answers on the 4th ring, there are no new messages. To save the toll charges for the call, hang up immediately when you hear the 3rd ring. The 3rd ring indicates that there are no new messages.

Remote Code **Handset**

The remote code prevents unauthorized people from accessing your unit and listening to your messages from any touch tone phone (see “Remote Operation from a Touch Tone Phone” on page 28).

Choose any **2-digit number (00–99)** for your remote code.

The factory preset remote code is “11”. If you do not program your own remote code, you can use “11”.

- 1** Press **[VOICE ENHANCER]**.
 - The indicator flashes.
- 2** Press **[1]**.
 - The current remote code is displayed on the base unit.
- 3** Enter a **2-digit remote code (00–99)**.
- 4** Press **[VOICE ENHANCER]**.
 - The handset beeps and the indicator light goes out.

To confirm the remote code, repeat steps 1 and 2.

- The remote code is displayed. When finished, press **[OFF]**.

Making Calls

Handset

- 1 Press [**☎**].
 - The TALK indicator lights.
- 2 Dial a phone number.
- 3 To hang up, press [**OFF**] or place the handset on the base unit.
 - The indicator light goes out.

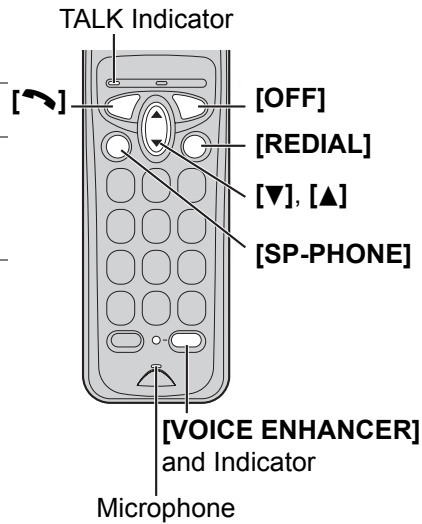

Telephone System

To have a hands-free phone conversation

- 1 Press [**SP-PHONE**].
 - The TALK indicator lights.
- 2 Dial a phone number.
- 3 When the other party answers, speak into the microphone.
- 4 To hang up, press [**OFF**] or place the handset on the base unit.
 - The indicator light goes out.

Hands-free Digital Duplex Speakerphone

For best performance, please note the following:

- Speak alternately with the other party in a quiet room.
- If you or the other party has difficulty hearing, press [**▼**] to decrease the speaker volume.
- While talking using [**☎**], you can switch to a hands-free phone conversation by pressing [**SP-PHONE**]. To switch back to the receiver, press [**☎**].

Making Calls

To redial the last number dialed

Press [**↶**] or [**SP-PHONE**], then press [**REDIAL**].

To adjust the receiver/speaker volume during a conversation

There are 3 volume levels for the receiver and 6 volume levels for the speaker.

To increase volume, press [**▲**].

To decrease volume, press [**▼**].

- If you try to increase/decrease volume when it is at the maximum/minimum level, the handset will beep 3 times.

Voice Enhancer Technology

Panasonic's Voice Enhancer Technology clarifies the voice of the person you are talking to, reproducing a more natural-sounding voice that is easier to hear and understand.

Voice Enhancer Technology can be turned on or off. The factory preset is OFF.

- Depending on the condition and quality of your telephone line, Voice Enhancer may emphasize existing line noise. If it becomes difficult to hear the caller, turn this feature off.

To turn this feature on, press [**VOICE ENHANCER**] during a conversation.

- The indicator lights in talk or speakerphone mode.
- The indicator light goes out after hanging up a call, but this feature still remains on.
- **To turn this feature off**, press [**VOICE ENHANCER**] again. The indicator light goes out.

Lighted handset keypad

The handset dialing buttons will light for a few seconds after pressing a button or lifting the handset off the base unit. They will also light when a call is being received.

Answering Calls

Handset

When a call is received, the handset rings, and the Ringer indicator on the handset and “**LINE IN USE**” on the base unit flash rapidly.

1 If the handset is off the base unit, press [] or [SP-PHONE].

- You can also answer a call by pressing any buttons except [▼], [▲] or [OFF].

OR

If the handset is on the base unit, just lift up.

2 To hang up, press [OFF] or place the handset on the base unit.

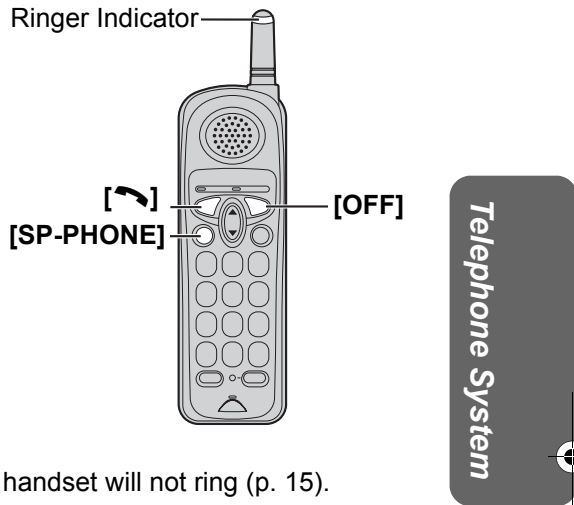

- If the ringer volume is turned off, the handset will not ring (p. 15).

Temporary ringer off

While the handset is ringing for an outside call, you can turn the ringer off temporarily by pressing [OFF]. The handset will ring again as usual the next time a call is received.

Special Features

Handset Locator **Base Unit**

You can locate the handset or page the handset user with beep tones from the base unit.

1 Press **[HANDSET LOCATOR]**.

- The Ringer indicator on the handset and "**IN USE**" on the base unit flash rapidly and the handset beeps for 1 minute.

2 To stop paging, press **[HANDSET LOCATOR]** again.

OR

Press **[OFF]** on the handset.

- You can also stop paging on the handset by pressing any buttons except **[▼]** or **[▲]**.

Temporary Tone Dialing

(For Rotary or Pulse Service Users) **Handset**

Press **[*]** (TONE) before entering access numbers which require tone dialing.

- The dialing mode changes to tone. You can enter numbers to access an answering service, electronic banking service, etc. When you hang up, the dialing mode will return to pulse.

For Call Waiting Service Users **Handset**

Press **[FLASH/CALL WAIT]** if you hear a call waiting tone during a conversation.

- The first call is put on hold and you can answer the second call.
- To return to the first caller, press **[FLASH/CALL WAIT]** again.
- Call Waiting service cannot be used when the Answering System is handling a call.
- If this function does not operate properly, consult your telephone company for details.

FLASH Button **Handset**

Pressing **[FLASH/CALL WAIT]** allows you to use special features of your host PBX such as transferring an extension call, or accessing optional telephone services such as Call Waiting.

- Pressing **[FLASH/CALL WAIT]** cancels Temporary Tone Dialing mode.

Special Features

Re-registering the Handset **Handset & Base Unit**

If an alarm tone sounds when you press [**↶**], [**SP-PHONE**] or [**VOICE ENHANCER**] even when using the handset near the base unit, the handset may have lost communication with the base unit. You need to re-register the handset to the base unit.

- **Make sure the base unit is not being used.**
- **Have both the handset and base unit nearby during registration.**
- **Follow steps 1 and 2 listed below. You have about 1 minute to complete them.**

1 *Base unit:*

Press and hold [**HANDSET LOCATOR**].

- The CHARGE indicator flashes.

2 *Handset:*

Press and hold [**FLASH/CALL WAIT**] until a beep sound.

- The VOICE ENHANCER indicator flashes.
 - When registration is complete, a beep sounds from the handset and the indicator lights go out.
 - **Wait for 20 seconds after registration is complete while the handset establishes communication with the base unit.**
- If the handset beeps 3 times in step 2, an error occurred. Try again from step 1.
 - You can stop registration by pressing [**OFF**] on the handset, and pressing [**HANDSET LOCATOR**] on the base unit.

Automatic Answering Operation

When the unit answers a call, a greeting message is played and the caller's message is recorded.

- The total recording time (including greeting message) is **about 10 minutes**. If messages are recorded in noisy rooms, the time may be shortened by up to 3 minutes.
- Each caller's recording time is up to 3 minutes.
- A maximum of 64 messages (including greeting message) can be recorded.

Setting the Unit to Answer Calls **Base Unit**

Press **[ANSWER ON]** to turn on the Answering System.

- The indicator lights and the unit announces "Answer set" and current day and time. If "Answer set. Set time" is heard, set the time and day (p. 13).
- The unit will announce the remaining recording time if it is less than 3 minutes.
- When no recording time is available, you will need to erase any unnecessary messages before new messages can be recorded (p. 27). The unit can indicate that memory is full in the following ways:
 - "**FULL**" will flash on the base unit and the ANSWER ON indicator will flash rapidly until you erase a message.
 - The unit will announce "Memory full" when you press **[ANSWER ON]** or **[GREETING REC]**, and after playing back messages or recording a message.

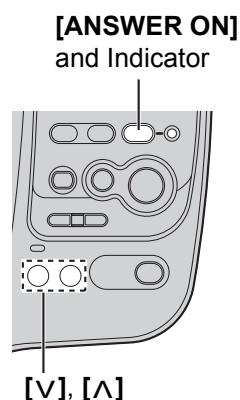

- If you do not want the unit to answer calls, press **[ANSWER ON]** again to turn off the Answering System. The indicator light goes out and "Answer off" is heard.
- You can also turn on the Answering System remotely from an outside phone (p. 30).

Automatic Answering Operation

Monitoring Incoming Calls **Base Unit**

While a caller is leaving a message, you can monitor the call through the base unit speaker.

- To increase the speaker volume while monitoring, press [**^**]. To decrease volume, press [**v**].

To answer a call while monitoring, lift the handset off the base unit, or press [**↶**] or [**SP-PHONE**] if the handset is off the base unit.

To turn the incoming call monitoring feature off

When the base unit is not in use, press [**GREETING CHECK**], then press [**v**] repeatedly until "0" is displayed. (Make sure the Answering System is turned on.)

OR

While monitoring, press [**v**] repeatedly until "0" is displayed.

- If the incoming call monitoring feature is turned off, it will remain off when the next call is monitored.
- If you adjust the speaker volume while playing back messages, the speaker volume for monitoring will be turned on again. To turn the speaker volume off, see "To turn the incoming call monitoring feature off" in the step above.

Answering System

Listening to Messages

You can see the total number of recorded messages on the base unit display. If the NEW MESSAGE indicator flashes on the base unit, new messages have been recorded.

Voice Day/Time Stamp: During playback, the unit will announce the day and time when each message was recorded (p. 13).

To play back messages **Base Unit**

Press **[MESSAGE]**.

- The unit announces the number of new messages and only new messages are played back.
- When you have no new messages, the unit announces “No new messages. All message playback” and plays back all messages.
- When you have no messages, the unit announces “No messages”.
- During playback, the display shows the message number.
- At the end of the last message, “End of final message” is heard. The unit will announce the remaining recording time if it is less than 3 minutes.
- If a call is received during playback, the handset rings and playback stops. To answer the call, lift the handset, or press **[📞]** or **[SP-PHONE]** if the handset is off the base unit. For playback, try again from the beginning after hanging up.

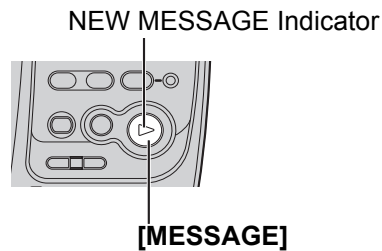

During playback **Base Unit**

To adjust the speaker volume	To increase volume, press [^] . To decrease volume, press [v] .
To repeat a message	Press [REPEAT] . • If pressed within the first 5 seconds of playback, the previous message will be played.
To skip a message	Press [SKIP] .
To stop playback	Press [STOP] . • To resume playback, press [MESSAGE] . • If you do not press any buttons for 60 seconds or if you press [STOP] again, playback mode will be cancelled.

Erasing Messages

Base Unit

The unit will announce the remaining recording time after playback if it is less than 3 minutes.

New messages cannot be recorded when:

- “Memory full” is heard.
- “**FULL**” flashes on the base unit.
- the ANSWER ON indicator flashes rapidly (when the Answering System is on).

We recommend that you erase unnecessary messages after each playback.

Erasing a specific message

Press **[ERASE]** while the message you want to erase is being played.

- The unit beeps, then plays back the next message. To exit playback mode, press **[STOP]** twice.

ANSWER ON Indicator

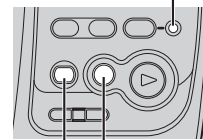

Erasing all messages

All recorded messages, except the greeting message, can be erased at one time.

- 1** Press **[ERASE]** while the base unit is not being used.
 - “To erase all messages, press ERASE again” is heard.
- 2** Within 10 seconds, press **[ERASE]** again.
 - The unit beeps, then announces “No messages”.
 - The base unit display shows “0”.

Answering System

Remote Operation from a Touch Tone Phone

While outside, you can operate the Answering System from any touch tone phone.

A synthesized voice menu will guide you through the Answering System (p. 29).

- To skip the voice menu and operate the unit directly, see page 30.

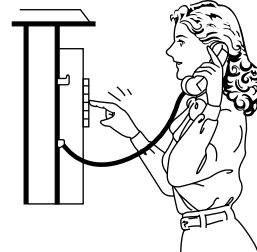

Summary of remote operation

Call your unit from a touch tone phone.



Enter your remote code (factory preset: 11, see "Remote Code" on page 18) during or after the greeting message.

- The number of new messages is heard, and the new messages will be played.*



After 3 seconds, the voice menu will start (p. 29).
Follow the menu or enter direct commands (p. 30).



To end remote operation, hang up.

- The unit will announce the remaining recording time after playback if it is less than 3 minutes.
- The messages are saved.

*If "No new messages" is announced, the unit has only old messages.

If "No messages" is announced, the unit has no messages.

Remote Operation from a Touch Tone Phone

Voice Menu

The shaded parts are voice prompts.

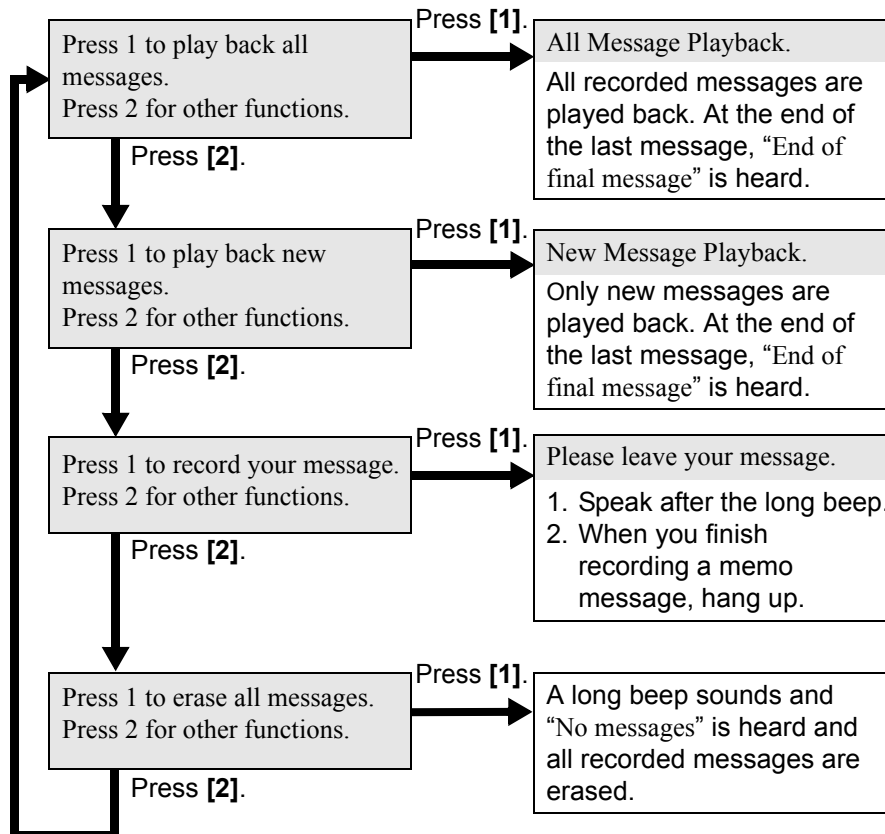

Answering System

- 3 seconds after playback, the voice menu will try again from the beginning.
- The unit will announce the remaining recording time after playback if it is less than 3 minutes.
- If you hear "Memory full" after playback, erase unnecessary messages (p. 30).
- If you do not press any buttons within 10 seconds after a voice prompt, "Thank you for your call." will be heard and the call will be disconnected.

Remote Operation from a Touch Tone Phone

Direct Remote Operation

Once you have entered the remote code, you can also control your unit by direct commands instead of using the voice menu. To end remote operation, hang up at any time.

Direct commands

[4] :	Plays back new messages.	[*] [4] :	Erases the current message. <ul style="list-style-type: none"> • A short beep will sound and the next message will be played.
[5] :	Plays back all messages.	[*] [5] :	Erases all messages. <ul style="list-style-type: none"> • A long beep will sound and "No messages" will be heard.
[1] :	Repeats the current message. <ul style="list-style-type: none"> • If pressed within the first 5 seconds of playback, the previous message will be played. 	[0] :	Turns off the Answering System. <ul style="list-style-type: none"> • The unit hangs up.
[2] :	Skips the current message.		
[9] :	Stops the current operation. <ul style="list-style-type: none"> • To resume, enter a direct command within 15 seconds, or the voice menu will start (p. 29). 		

To turn on the Answering System

Call your unit and wait for 15 rings.

- The unit will answer and the greeting will be played.
- The Answering System will be turned on. Hang up or enter the remote code for other options.
- When turning on the Answering System using a rotary or pulse service telephone, you cannot enter the remote code for other options.

Skipping the greeting

After calling your unit, press **[*]** during the greeting.

- The unit skips the rest of the greeting and you can start recording your message after the long beep.

Wall Mounting

This unit can be mounted on a wall phone plate.

- 1 Press the tabs in the direction of the arrows (①), then remove the wall mounting adaptor (②).

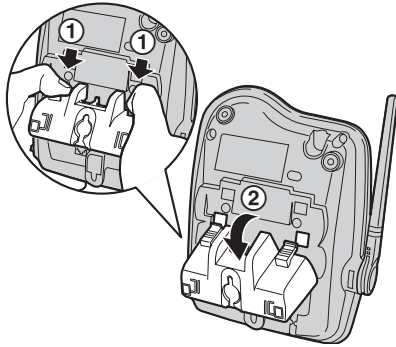

- 2 Connect the AC adaptor.
 - Fasten the AC adaptor cord to prevent it from being disconnected.

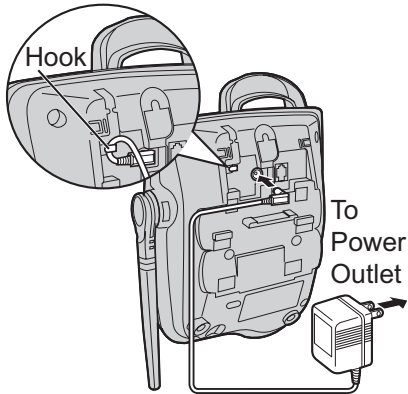

- 3 Tuck the telephone line cord inside the wall mounting adaptor, then push the adaptor in the direction of the arrows (① and ②) while pressing the tabs.

- The word "UP WALL" should face upward.

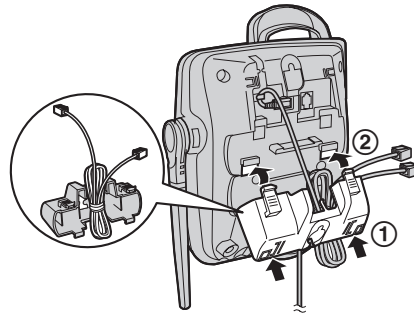

- 4 Connect the telephone line cord. Mount the unit, then slide it down.

- Raise the antenna.

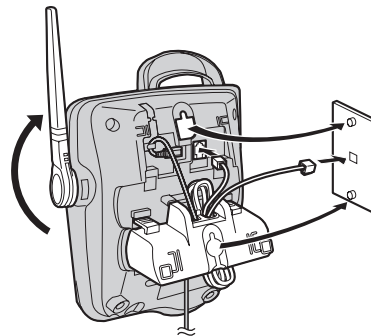

- 5 To charge the handset battery: Place the handset on the base unit.

- The unit beeps once and the CHARGE indicator lights.

Belt Clip

You can hang the handset on your belt or pocket using the included belt clip.

To attach the belt clip

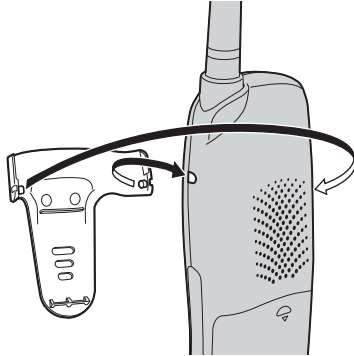

To remove the belt clip

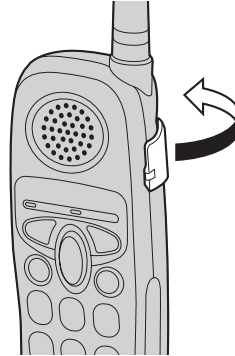

Shoulder Rest Attachment

Use the shoulder rest attachment if you need to keep your hands free during a phone conversation.

To attach the shoulder rest attachment

Attach the included belt clip to the handset (see above), then attach the shoulder rest attachment to the belt clip as shown below. You will hear a click when the shoulder rest attachment is in place.

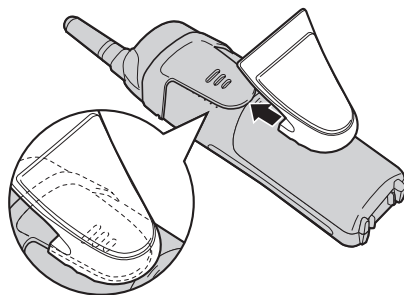

To remove the shoulder rest attachment

Slide the base of the attachment in the direction of the arrow as shown below.

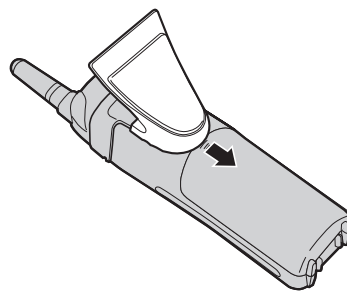

Optional Headset

Connecting an optional headset to the handset allows hands-free phone conversation. Please use only a Panasonic KX-TCA86, KX-TCA91, or KX-TCA92 headset.

Connecting an optional headset

Open the headset jack cover, and insert the headset plug into the headset jack as shown below.

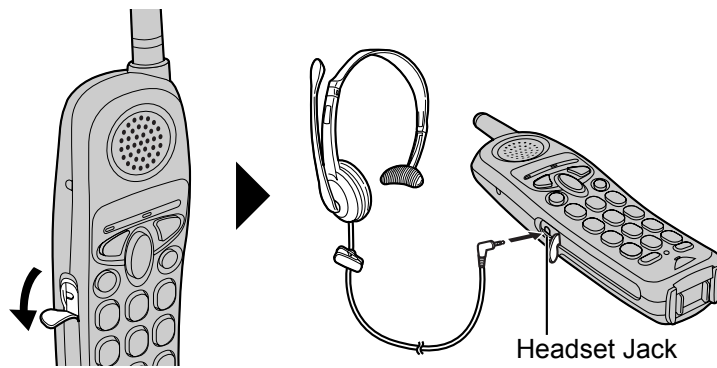

- Headset sold separately. Model shown here is KX-TCA86.

To switch to the speakerphone while using the headset:
Press [SP-PHONE]. To return to the headset, press [↶].

Troubleshooting

Telephone System

Problem	Cause & Remedy
An alarm tone sounds when you press [↶], [SP-PHONE] or [VOICE ENHANCER].	<ul style="list-style-type: none"> You are too far from the base unit. Walk closer to the base unit and try again. Confirm the AC adaptor is plugged in. Raise the base unit antenna. If the above remedies do not solve the problem, the handset may have lost communication with the base unit. Register the handset again (p. 23)
Static, sound cuts in/out, fades. Interference from other electrical units.	<ul style="list-style-type: none"> Move the handset and base unit away from other electrical appliances (p. 3). Walk closer to the base unit. Raise the base unit antenna.
The handset does not ring.	<ul style="list-style-type: none"> The ringer volume is turned off. Set to high, medium, or low (p. 15).
You cannot program any function items.	<ul style="list-style-type: none"> Programming is not possible while the handset is being used. Do not pause for over 60 seconds while programming. Walk closer to the base unit. While another user is listening to messages or the Answering System is handling a call, you cannot program. Try again later.
While programming, the handset starts to ring and the program stops.	<ul style="list-style-type: none"> A call is coming in. To answer the call, press [↶] or [SP-PHONE]. Try again from the beginning after hanging up.
You cannot redial.	<ul style="list-style-type: none"> If the last number dialed was more than 48 digits long, the number will not be redialed correctly.
You cannot make long distance calls.	<ul style="list-style-type: none"> Please make sure that you have long distance service.
You cannot page the handset.	<ul style="list-style-type: none"> The handset is too far from the base unit or is engaged in an outside call. Try again later.

Troubleshooting

Problem	Cause & Remedy
You cannot have a conversation using the headset.	<ul style="list-style-type: none"> • Make sure the optional headset is connected properly (p. 33). • [SP-PHONE] may have been pressed. Press [↶] to switch to the headset.
[FLASH/CALL WAIT] does not work properly.	<ul style="list-style-type: none"> • Set the flash time. Press [VOICE ENHANCER], [9] and [8], then press [VOICE ENHANCER] again.

Answering System

Problem	Cause & Remedy
The Answering System is on, but incoming messages are not recorded.	<ul style="list-style-type: none"> • Memory is full. Erase unnecessary messages (p. 27).
" Full " flashes and the ANSWER ON indicator flashes rapidly. No new messages are recorded.	<ul style="list-style-type: none"> • Memory is full. Erase unnecessary messages (p. 27).
You cannot operate the Answering System from the base unit.	<ul style="list-style-type: none"> • If another user is listening to messages or the Answering System is handling a call, you cannot operate the Answering System. Try again later.
You cannot operate the Answering System from a touch tone phone.	<ul style="list-style-type: none"> • Make sure you entered the correct remote code (p. 18). • The Answering System may not respond if the tones are too short to activate the unit. Press each button firmly. • The Answering System is off. Turn it on (p. 30).
You cannot erase messages.	<ul style="list-style-type: none"> • While another user is operating the Answering System or a caller is leaving a message, you cannot erase messages.

Useful Information

Troubleshooting

Problem	Cause & Remedy
When you play back messages or turn on the Answering System, the unit announces the wrong day and time.	<ul style="list-style-type: none"> • The time and day may be set incorrectly. Set the time and day again (p. 13).

General

Problem	Cause & Remedy
The unit does not work.	<ul style="list-style-type: none"> • Check the settings (p. 9–11). • Check whether the dialing mode setting is correct (p. 14). • Fully charge the battery (p. 10). • Clean the charge contacts and charge again (p. 11). • Check battery installation (p. 10). • Unplug the AC adaptor to reset it. Plug in, and try again. • Re-install the battery (p. 10) and fully charge it.
The RECHARGE indicator flashes, or the unit beeps intermittently.	<ul style="list-style-type: none"> • Fully charge the battery (p. 10).
You charged the battery fully, but the RECHARGE indicator continues to flash.	<ul style="list-style-type: none"> • Clean the charge contacts and charge again (p. 11). • The battery may need to be replaced. If you install a new battery, fully charge it (p. 10).
The CHARGE indicator does not go out after the battery has been charged.	<ul style="list-style-type: none"> • This is normal.

Important Information

NOTICE:

This equipment meets the applicable Industry Canada Terminal Equipment Technical Specifications. This is confirmed by the registration number. The abbreviation, "IC:", before the registration number signifies that registration was performed based on a Declaration of Conformity indicating that Industry Canada technical specifications were met. It does not imply that Industry Canada approved the equipment.

And, the term "IC:" signifies that Industry Canada radio technical specifications were met.

Before installing this equipment, users should ensure that it is permissible to be connected to the facilities of the local telecommunications company. The equipment must also be installed using an acceptable method of connection. The customer should be aware that compliance with the above conditions may not prevent degradation of service in some situations.

Repairs to certified equipment should be coordinated by a representative designated by the supplier. Any repairs or alterations made by the user to this equipment, or equipment malfunctions, may give the telecommunications company cause to request the user to disconnect the equipment.

Users should ensure, for their own protection, that the electrical ground connections of the power utility, telephone lines and internal metallic water pipe system, if present, are connected together. This precaution may be particularly important in rural areas.

Caution:

Users should not attempt to make such connections themselves, but should contact the appropriate electric inspection authority, or electrician, as appropriate.

NOTICE:

The **Ringer Equivalence Number (REN)** assigned to each terminal device provides an indication of the maximum number of terminals allowed to be connected to a telephone interface. The termination on an interface may consist of any combination of devices subject only to the requirement that the sum of the Ringer Equivalence Numbers of all the devices does not exceed 5.

The Ringer Equivalence Number (REN) of This Unit:
(found on the bottom of the unit).

NOTICE:

Operation is subject to the following two conditions: (1) this device may not cause interference, and (2) this device must accept any interference, including interference that may cause undesired operation of the device.

Privacy of communications may not be ensured when using this telephone.

Some cordless telephones operate at frequencies that may cause interference to nearby TVs and VCRs. To minimize or prevent such interference, the base of the cordless telephone should not be placed near, or on top of, a TV or VCR. If interference is experienced, move the cordless telephone further away from the TV or VCR. This will often reduce, or eliminate, interference.

Operating near 2.4 GHz electrical appliances may cause interference. Move away from the electrical appliances.

Safety Instructions

Take special care to follow the safety suggestions listed below.

Safety

- 1)The unit should be connected to a power supply only of the type described in the operating instructions or as marked on the unit.
- 2)When left unused for a long period of time, the base unit should be unplugged from the household AC outlet.

Installations

Environment

- 1)Do not use this unit near water- for example, near a bathtub, washbowl, sink, etc. Damp basements should also be avoided.
- 2)The unit should be kept away from heat sources such as radiators, kitchen range, etc. It also should not be placed in rooms where the temperature is less than 5°C (41°F) or greater than 40°C (104°F).
- 3)The AC adaptor is used as the main power source. Ensure that the AC outlet is located/installed near the unit and is easily accessible.

Placement

- 1)Do not place heavy objects on top of this unit.
- 2)Care should be taken so that objects do not fall onto, and liquids are not spilled into, the unit. Do not subject this unit to excessive smoke, dust, mechanical vibration or shock.
- 3)Place the unit on a flat surface.

For best performance

- 1)If noise prevents the conversation from being understood on the handset, approach the base unit to lessen the noise.
- 2)The handset should be used at the HIGH volume setting when the reception tone is difficult to hear.
- 3)The handset should be fully recharged on the base unit when the RECHARGE indicator flashes.
- 4)The handset antenna should not be touched during use because of its high sensitivity.
- 5)The maximum calling distance may be shortened when the unit is used in the following places: Near obstacles such as hills, tunnels, undergrounds, near metal objects such as wire fences, etc.

Medical

Consult the manufacturer of any personal medical devices, such as pacemakers or hearing aids, to determine if they are adequately shielded from external RF (radio frequency) energy. (The unit operates in the frequency range of 2400MHz to 2481MHz, and the power output level can range 0.04 to 0.1 watts.) Do not use the unit in health care facilities if any regulations posted in the area instruct you not to do so. Hospitals or health care facilities may be using equipment that could be sensitive to external RF (radio frequency) energy.

Safety Instructions

WARNING:

TO PREVENT FIRE OR SHOCK HAZARD, DO NOT EXPOSE THIS PRODUCT TO RAIN OR ANY TYPE OF MOISTURE.

If there is any trouble, disconnect the unit from the telephone line and connect a known working phone. If the known working phone operates properly, have your unit repaired by one of the specified authorized Panasonic Factory Servicentres. If the known working phone does not operate properly, consult your telephone company.

Specifications

■ Base unit

Power Supply: AC Adaptor (120 V AC, 60 Hz)

Power Consumption: Standby: Approx. 2.1 W
Maximum: Approx. 5.0 W

Frequency: 2.4 GHz – 2.48 GHz

Dimensions (H x W x D): Approx. 124 mm x 155 mm x 174 mm
(4 ⁷/₈" x 6 ³/₃₂" x 6 ²⁷/₃₂")

Mass (Weight): Approx. 390 g (0.86 lb.)

■ Handset

Power Supply: Ni-MH battery (3.6 V, 830 mAh)

Frequency: 2.4 GHz – 2.48 GHz

Dimensions (H x W x D): Approx. 208 mm x 52 mm x 39 mm
(8 ³/₁₆" x 2 ¹/₁₆" x 1 ¹⁷/₃₂")

Mass (Weight): Approx. 190 g (0.42 lb.)

Security Codes: 1,000,000

■ Dialing Mode: Tone (DTMF)/Pulse

■ Operating Environment: 5 °C – 40 °C (41 °F – 104 °F)

Specifications are subject to change without notice.

Panasonic Canada Inc.

5770 Ambler Drive, Mississauga, Ontario L4W 2T3
PANASONIC PRODUCT—LIMITED WARRANTY

Panasonic Canada Inc. warrants this product to be free from defects in material and workmanship and agrees to remedy any such defect for a period as stated below from the date of original purchase.

Telephone Accessory/Product	—One (1) year, parts and labour
FRS (Family Radio Service) Product	—One (1) year, parts and labour

LIMITATIONS AND EXCLUSIONS

This warranty does not apply to products purchased outside Canada or to any product which has been improperly installed, subjected to usage for which the product was not designed, misused or abused, damaged during shipping, or which has been altered or repaired in any way that affects the reliability or detracts from the performance, nor does it cover any product which is used commercially. Dry cell batteries are also excluded from coverage under this warranty. Rechargeable batteries are warranted for ninety (90) days from date of original purchase.

This warranty is extended to the original end user purchaser only. A purchase receipt or other proof of date of original purchase is required before warranty service is performed.

THIS EXPRESS, LIMITED WARRANTY IS IN LIEU OF ALL OTHER WARRANTIES, EXPRESS OR IMPLIED, EXCLUDING ANY IMPLIED WARRANTIES OF MERCHANTABILITY OR FITNESS FOR A PARTICULAR PURPOSE. IN NO EVENT WILL PANASONIC CANADA INC. BE LIABLE FOR ANY SPECIAL, INDIRECT OR CONSEQUENTIAL DAMAGES.

In certain instances, some jurisdictions do not allow the exclusion or limitation of incidental or consequential damages, or the exclusion of implied warranties, so the above limitations and exclusions may not be applicable.

WARRANTY SERVICE

For product operation and information assistance, please contact your Dealer or our Customer Care Centre at:

Telephone #: (905) 624-5505 Fax #: (905) 238-2360 Web: www.panasonic.ca

For product repairs, please contact one of the following:

- Your Dealer who will inform you of an authorized Servicentre nearest you.
- Our Customer Care Centre at (905) 624-5505 or www.panasonic.ca
- A Panasonic Factory Servicentre listed below:

Richmond, British Columbia

Panasonic Canada Inc.
12111 Riverside Way
Richmond, BC V6W 1K8
Tel: (604) 278-4211
Fax: (604) 278-5627

Calgary, Alberta

Panasonic Canada Inc.
6835-8th St. N. E.
Calgary, AB T2E 7H7
Tel: (403) 295-3955
Fax: (403) 274-5493

Mississauga, Ontario

Panasonic Canada Inc.
5770 Ambler Dr.
Mississauga, ON L4W 2T3
Tel: (905) 624-8447
Fax: (905) 238-2418

Lachine, Québec

Panasonic Canada Inc.
3075, rue Louis A. Amos
Lachine, QC H8T 1C4
Tel: (514) 633-8684
Fax: (514) 633-8020

IF YOU SHIP THE PRODUCT TO A SERVICENTRE

Carefully pack and send prepaid, adequately insured and preferably in the original carton. Include details of the defect claimed, and proof of date of original purchase.

Panasonic Canada Inc.

5770 Ambler Drive, Mississauga, Ontario L4W 2T3

© 2004 Panasonic Communications Co., Ltd. All Rights Reserved.

PQQX14047ZA S0204-0

Free Manuals Download Website

<http://myh66.com>

<http://usermanuals.us>

<http://www.somanuals.com>

<http://www.4manuals.cc>

<http://www.manual-lib.com>

<http://www.404manual.com>

<http://www.luxmanual.com>

<http://aubethermostatmanual.com>

Golf course search by state

<http://golfingnear.com>

Email search by domain

<http://emailbydomain.com>

Auto manuals search

<http://auto.somanuals.com>

TV manuals search

<http://tv.somanuals.com>