

Panasonic

Operating Instructions

Personal Facsimile

Model No. **KX-FT902HK**

Model No. **KX-FT904HK**

Facsimile
with Digital Answering System

Model No. **KX-FT908HK**



KX-FT908

Thank you for purchasing a Panasonic fax machine.

Please read these operating instructions before using the unit and save for future reference.

1. Installation and Quick Start

Installation

- 1.1 Included accessories 4
- 1.2 Accessory information 4
- 1.3 Connections 5
- 1.4 Recording paper 6

Quick Start

- 1.5 Fax sending / Copying 7
- 1.6 Fax receiving 7
- 1.7 Answering device (KX-FT908 only) 8
- 1.8 Help function 9

2. Important Information

Important Instructions

- 2.1 Important safety instructions 10
- 2.2 For best performance 11

3. Preparation

Finding the Controls

- 3.1 Location of controls 12
- 3.2 Overview 13

Volume

- 3.3 Adjusting volume 14

Initial Programming

- 3.4 Date and time 14
- 3.5 Your logo 15
- 3.6 Your fax number 17

4. Telephone

Automatic Dialling

- 4.1 Storing names and telephone numbers for the one-touch dial feature and navigator directory 18
- 4.2 Making phone calls using the one-touch dial feature and navigator directory .. 20

Recording

- 4.3 Recording a telephone conversation (KX-FT908 only) 21

Caller ID

- 4.4 Caller ID service 21
- 4.5 Viewing and calling back using caller information 22
- 4.6 Storing caller information for the one-touch dial feature and navigator directory 24

Dial Lock

- 4.7 Setting the dial lock feature 25

Voice Contact

- 4.8 Talking to the other party after fax transmission or reception 26

5. Fax

Sending Faxes

- 5.1 Sending a fax manually 27
- 5.2 Documents you can send 27
- 5.3 Sending faxes using the one-touch dial feature and navigator directory 28
- 5.4 Broadcast transmission (KX-FT904/ KX-FT908 only) 29
- 5.5 Transmit polling (letting another machine retrieve a fax on your unit) . 31

Receiving Faxes

- 5.6 Selecting the way to use your fax machine 32
- 5.7 Receiving a fax manually – Auto answer OFF 34
- 5.8 Receiving a fax automatically – Auto answer ON 35
- 5.9 Receive polling (retrieving a fax placed on another fax machine) 37
- 5.10 Black list function 37
- 5.11 Pager call 38

6. Duplex Ring

Duplex Ring

- 6.1 Using with the ring detection feature 39

7. Copy

Copying

- 7.1 Making a copy 40

8. Answering Device (KX-FT908 only)

Greeting

- 8.1 Recording your greeting messages .. 41

Memo Message

- 8.2 Leaving a message for others or yourself 42

Incoming Messages

- 8.3 Listening to recorded messages 42

Remote Operation

- 8.4 Operating from a remote location 44

Message transfer

- 8.5 Transferring recorded messages to another telephone 46

9. Programmable Features

Features

- 9.1 Programming 47
- 9.2 Basic features 48
- 9.3 Advanced features 49

10.Help

Error Messages

- 10.1 Error messages – Reports 52
- 10.2 Error messages – Display 52

Troubleshooting

- 10.3 When a function does not work, check here 54

Jams

- 10.4 Recording paper jams 56
- 10.5 Document jams – sending 57

Cleaning

- 10.6 Document feeder / scanner glass cleaning 58
- 10.7 Thermal head / head cover cleaning 59

11.General Information

Printed Reports

- 11.1 Reference lists and reports 60

Specifications

- 11.2 Specifications 61

User record

- 11.3 User record 62

12.Index

- 12.1 Index 63

1. Installation and Quick Start

1.1 Included accessories

| No. | Item | Quantity |
|-----|--|----------|
| ① | Power cord | 1 |
| ② | Telephone line cord | 1 |
| ③ | Handset | 1 |
| ④ | Handset cord | 1 |
| ⑤ | Recording paper (10 metres long) | 1 |
| ⑥ | Paper stacker (KX-FT904/KX-FT908 only) | 1 |
| ⑦ | Operating instructions | 2 |

①

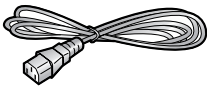

②



③



④

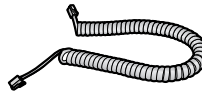

⑤

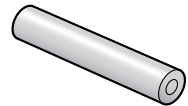

⑥



⑦



Note:

- If any items are missing or damaged, contact the place of purchase.
- Save the original carton and packing materials for future shipping and transportation of the unit.

1.2 Accessory information

| Model No. | Item | Note |
|-----------|----------------------------------|-------------------------------------|
| KX-A106 | Standard thermal recording paper | 216 mm × 30 m roll, with 25 mm core |

Note:

- Use only the included or specified recording paper. Using other recording paper may affect print quality and/or cause excessive wear to the thermal head.

1.3 Connections

- ① Handset cord
 - The longer, uncoiled end should be connected to the unit.
- ② Telephone line cord
 - Connect to the single telephone line jack.
- ③ Power cord
 - Connect to the power outlet (220 V – 240 V, 50/60 Hz).
- ④ Paper stacker (KX-FT904/KX-FT908 only)
 - The paper stacker may not be shown in all illustrations in these operating instructions.
- ⑤ [EXT] jack (KX-FT902/KX-FT904 only)
 - Remove the stopper if attached.
- ⑥ Extension telephone (not included)

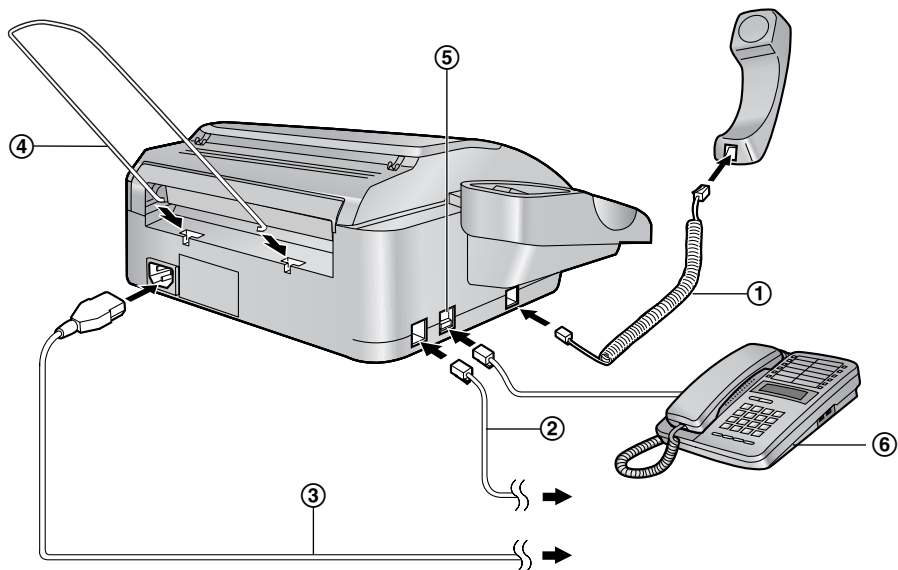

Caution:

- When you operate this product, the power outlet should be near the product and easily accessible.
- Be sure to use the telephone line cord included in this unit.
- Do not extend the telephone line cord.
- Keep the unit away from walls as far as possible to prevent a recording paper jam.

1.4 Recording paper

- 1 Open the cover by pressing the cover open button (1).

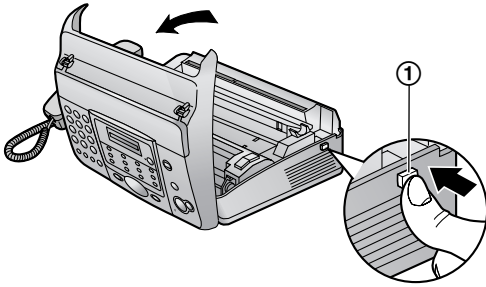

- 2 Install the recording paper.

Correct

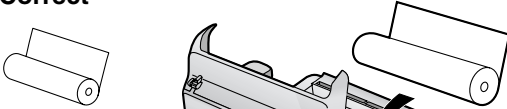

Incorrect

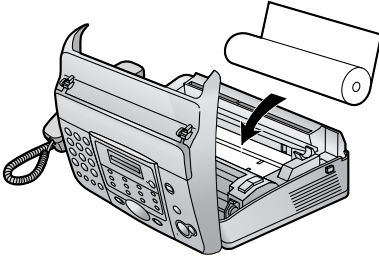

- 3 Insert the leading edge of the paper into the opening above the thermal head (1).

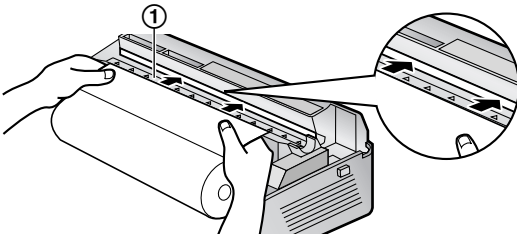

- 4 Pull the paper out of the unit.

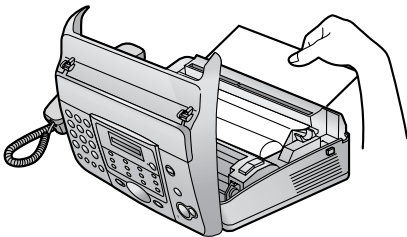

- Make sure that there is no slack in the paper roll.

- 5 Close the cover securely by pushing down on both sides.

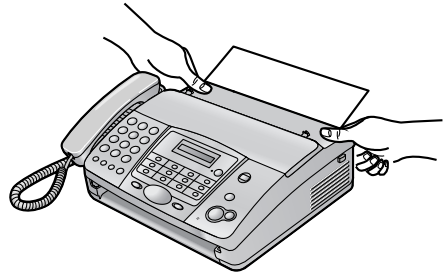

- 6 For KX-FT902:
Press [FAX/START], then tear off the excess paper by pulling it towards you.



- For KX-FT904/KX-FT908:
Press [FAX/START] to cut the paper.

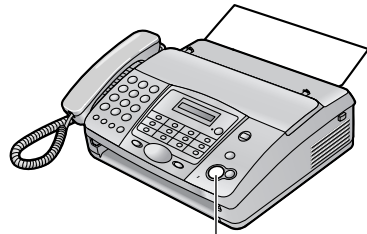

[FAX/START]

Note:

- If the paper is secured with glue or tape, cut approximately 15 cm from the beginning of the roll before installing it.
- When the power cord is connected, a message is printed each time the cover is opened then closed. If the recording paper is installed upside down, the message will not be printed. Install the paper correctly.
- For accessory information, see page 4.

1.5 Fax sending / Copying

- 1 Open the document feeder tray.



- 2 Adjust the document guides (1), and insert the document FACE DOWN.

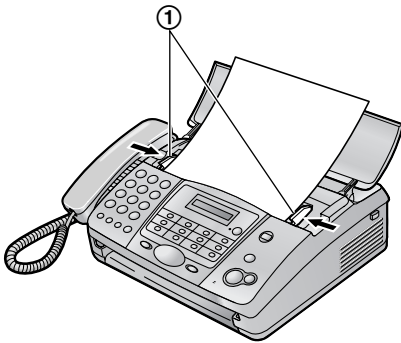

- 3 To send a fax:
Dial the fax number and press
[FAX/START].

To make a copy:
Press [COPY].

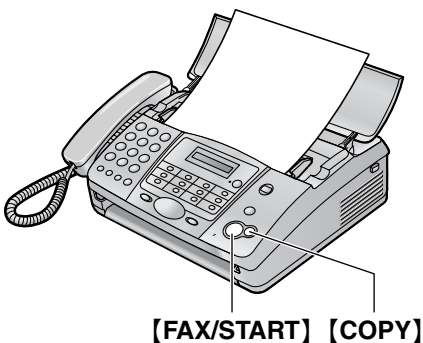

- For further details to send a fax, see page 27.
For further details to make a copy, see page 40.

1.6 Fax receiving

- 1 Lift the handset to answer the call.
- 2 To receive a fax document, press
[FAX/START].

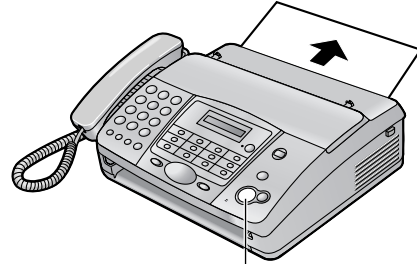

[FAX/START]

- For further details, see page 34.
- You can select how you want the unit to receive calls according to your needs (page 32).

1.7 Answering device (KX-FT908 only)

1.7.1 Recording your own greeting message

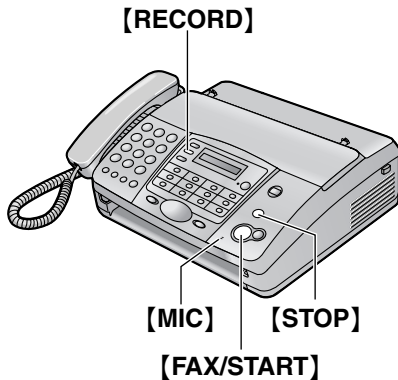

- ❶ Press **[RECORD]** 2 times.
- ❷ Press **[FAX/START]**.
- ❸ Speak clearly about 20 cm away from **[MIC]**, for up to 16 seconds.
- ❹ To stop recording, press **[STOP]**.
 - For further details, see page 41.

1.7.2 Listening to recorded messages

The display will show the total number of recorded messages.

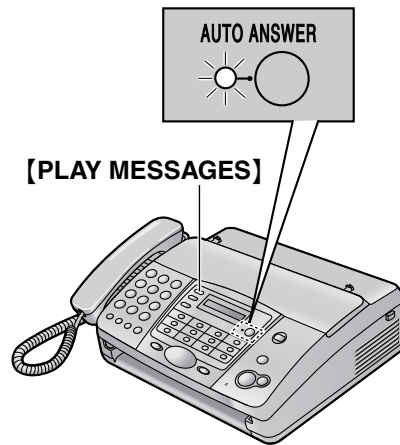

When the [AUTO ANSWER] indicator flashes:

Press **[PLAY MESSAGES]**. New messages will be played.

When the [AUTO ANSWER] indicator is ON:

Press **[PLAY MESSAGES]**. All messages will be played.

- For further details, see page 42.

1.8 Help function

The unit contains helpful information which can be printed for quick reference.

How to set up:

How to program your unit.

Directory:

How to use the one-touch dial feature and navigator directory.

Auto answer:

Explanation of the auto answer setting.

Caller ID:

How to use the Caller ID features.

Telephone answering device operation (KX-FT908 only):

How to use the answering device.



- 1 Press **[HELP]** repeatedly to display the desired item.
- 2 Press **[SET]**.
 - The selected item will be printed.

2.1 Important safety instructions

When using this unit, basic safety precautions should always be followed to reduce the risk of fire, electric shock, or personal injury.

1. Read and understand all instructions.
2. Follow all warnings and instructions marked on this unit.
3. Unplug this unit from power outlets before cleaning. Do not use liquid or aerosol cleaners. Use a damp cloth for cleaning.
4. Do not use this unit near water, for example near a bathtub, wash bowl, kitchen sink, etc.
5. Place the unit securely on a stable surface. Serious damage and/or injury may result if the unit falls.
6. Do not cover slots and openings on the unit. They are provided for ventilation and protection against overheating. Never place the unit near radiators, or in a place where proper ventilation is not provided.
7. Use only the power source marked on the unit. If you are not sure of the type of power supplied to your home, consult your dealer or local power company.
8. For safety purposes this unit is equipped with a grounded plug. If you do not have this type of outlet, please have one installed. Do not defeat this safety feature by tampering with the plug.
9. Do not place objects on the power cord. Install the unit where no one can step or trip on the cord.
10. Do not overload power outlets and extension cords. This can result in the risk of fire or electric shock.
11. Never push any objects through slots in this unit. This may result in the risk of fire or electric shock. Never spill any liquid on the unit.
12. To reduce the risk of electric shock, do not disassemble this unit. Take the unit to an authorised service centre when service is required. Opening or removing covers may expose you to dangerous voltage or other risks. Incorrect reassembly can cause electric shock when the unit is subsequently used.
13. Unplug this unit from power outlets and refer servicing to an authorised service centre when the following conditions occur:
 - A. When the power cord is damaged or frayed.
 - B. If liquid has been spilled into the unit.
 - C. If the unit has been exposed to rain or water.
 - D. If the unit does not work normally by following the operating instructions. Adjust only controls covered by the operating instructions. Improper adjustment may require extensive work by an authorised service centre.
 - E. If the unit has been dropped or physically damaged.
 - F. If the unit exhibits a distinct change in performance.
14. During thunderstorms, avoid using telephones except cordless types. There may be a remote risk of an electric shock from lightning.
15. Do not use this unit to report a gas leak, when in the vicinity of the leak.

| |
|--------------------------------|
| SAVE THESE INSTRUCTIONS |
|--------------------------------|

CAUTION:

Installation

- Never install telephone wiring during a lightning storm.
- Never install telephone jacks in wet locations unless the jack is specifically designed for wet locations.
- Never touch uninsulated telephone wires or terminals unless the telephone line has been disconnected at the network interface.
- Use caution when installing or modifying telephone lines.
- Do not touch the plug with wet hands.

WARNING:

- To prevent the risk of fire or electrical shock, do not expose this product to rain or any type of moisture.

2.2 For best performance

Environment

- Keep the unit away from electrical noise generating devices, such as fluorescent lamps and motors.
- The unit should be kept free from dust, high temperature and vibration.
- The unit should not be exposed to direct sunlight.
- Do not place heavy objects on top of the unit.
- The unit should be kept away from heat sources such as heaters, kitchen stoves, etc. It also should not be placed in rooms where the temperature is less than 5 °C or greater than 35 °C. Damp basements should also be avoided.

Connection

- If any other device is connected on the same line, this unit may disturb the network condition of the device.
- If you use the unit with a computer and your internet provider instructs you to install a filter (①), please connect the telephone line cord as follows.

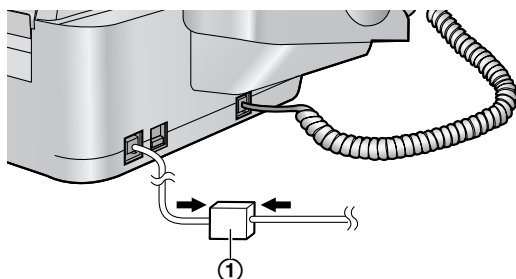

Speakerphone operation (KX-FT908 only)

- Use the speakerphone in a quiet room.

Routine care

- Wipe the outer surface of the unit with a soft cloth. Do not use benzine, thinner, or any abrasive powder.

3.1 Location of controls

KX-FT902
KX-FT904

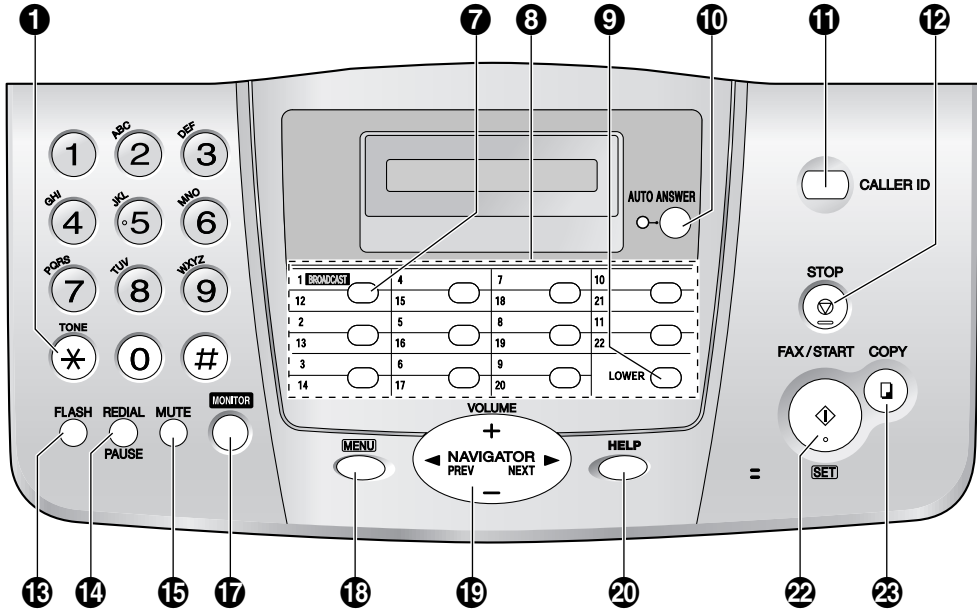

* The pictured model is KX-FT904.

KX-FT908

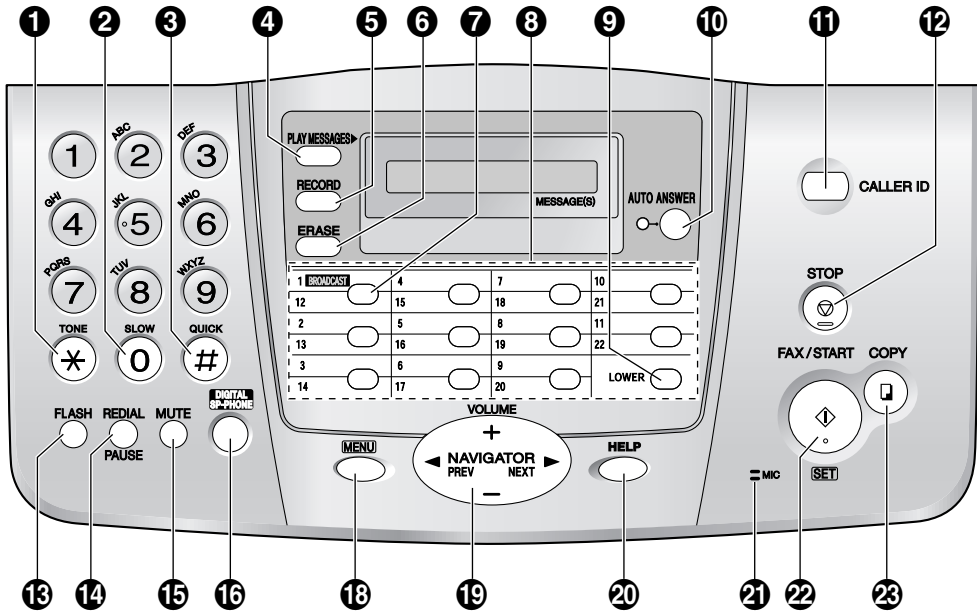

- 1 [TONE]**
 - To change from pulse to tone temporarily during dialling when your line has rotary pulse services.
- 2 [SLOW] (KX-FT908 only)**
 - To slow down message playback (page 43).
- 3 [QUICK] (KX-FT908 only)**
 - To speed up message playback (page 43).
- 4 [PLAY MESSAGES] (KX-FT908 only)**
 - To play messages (page 42).
- 5 [RECORD] (KX-FT908 only)**
 - To record messages (page 41, 42).
- 6 [ERASE] (KX-FT908 only)**
 - To erase messages (page 41, 43).
- 7 [BROADCAST] (KX-FT904/KX-FT908 only)**
 - To transmit a document to multiple parties (page 29).
- 8 Station keys**
 - To use the one-touch dial feature (page 18, 20, 28).
- 9 [LOWER]**
 - To select stations 12–22 for the one-touch dial feature (page 18, 20, 28).
- 10 [AUTO ANSWER]**
 - To turn ON/OFF the auto answer setting (page 32).
- 11 [CALLER ID]**
 - To use Caller ID features (page 22, 24).
- 12 [STOP]**
 - To stop an operation or programming.
- 13 [FLASH]**
 - To access special telephone services or for transferring extension calls.
- 14 [REDIAL][PAUSE]**
 - To redial the last number dialled. If the line is busy when you make a phone call using the **[MONITOR]** (KX-FT902/KX-FT904)/**[DIGITAL SP-PHONE]** (KX-FT908) button, the unit will automatically redial the number up to 5 times.
 - To insert a pause during dialling.
- 15 [MUTE]**
 - To mute your voice to the other party during a conversation. Press this button again to resume the conversation.
- 16 [DIGITAL SP-PHONE] (KX-FT908 only)**
 - For speakerphone operation (page 11, 20).

- 17 [MONITOR] (KX-FT902/KX-FT904 only)**
 - To initiate dialling without lifting the handset.
- 18 [MENU]**
 - To initiate or exit programming.
- 19 [NAVIGATOR][VOLUME]**
 - To adjust volume (page 14).
 - To search for a stored item (page 20, 28).
 - To select features or feature settings during programming (page 47).
 - To navigate to the next operation.
- 20 [HELP]**
 - To print helpful information for quick reference (page 9).
- 21 [MIC] (KX-FT908 only)**
 - The built-in microphone.
- 22 [FAX/START][SET]**
 - To start sending or receiving a fax.
 - To store a setting during programming.
- 23 [COPY]**
 - To copy a document (page 40).

3.2 Overview

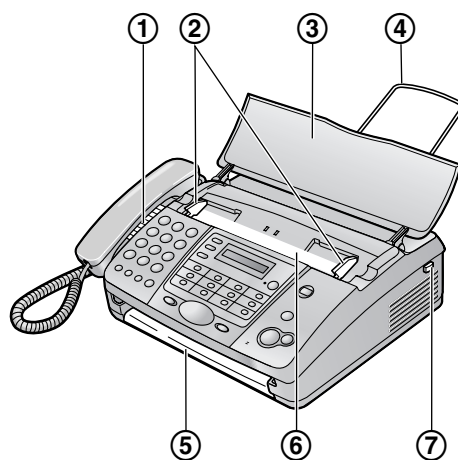

* The pictured model is KX-FT908.

- 1 Speaker**
- 2 Document guides**
- 3 Document feeder tray**
- 4 Paper stacker (KX-FT904/KX-FT908 only)**
 - The paper stacker may not be shown in all illustrations in these operating instructions.
- 5 Document exit**
- 6 Document entrance**
- 7 Cover open button**

3.3 Adjusting volume

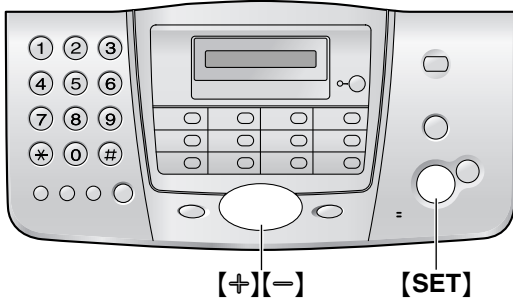

Ringer volume

4 levels (high/medium/low/off) are available.

While the unit is idle, press [+].

- If any documents are in the document entrance, you cannot adjust the volume. Confirm that there are no documents in the entrance.

To turn the ringer OFF

1. Press [-] repeatedly to display "RINGER OFF= OK?".
2. Press [SET].
 - When a call is received, the unit will not ring and will display "INCOMING CALL".
 - To turn the ringer back ON, press [+].

Handset receiver volume

3 levels (high/middle/low) are available.

While using the handset, press [+].

Speaker volume

8 levels (high to low) are available.

While using the monitor/speakerphone, press [+].

Voice guidance volume (KX-FT908 only)

9 levels (high to off) are available.

While listening to voice guidance, press [+].

Answering device volume (KX-FT908 only)

9 levels (high to off) are available.

While listening to recorded messages, press [+].

3.4 Date and time

You must set the date and time.

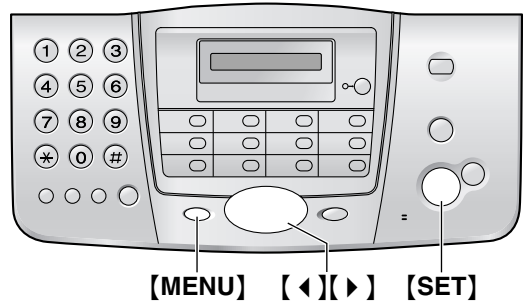

- 1 Press [MENU].

SYSTEM SET UP

- 2 Press [SET].

PRESS [◀▶] & [SET]

- 3 Press [◀] or [▶] repeatedly to display the following.

SET DATE & TIME

- 4 Press [SET].

- The underbar shows the position of the cursor.

M: 01 / D: 01 / Y: 04

- 5 Enter the current month/date/year by selecting 2 digits for each.

Example: August 10, 2004

Press [0][8][1][0][0][4].

M: 08 / D: 10 / Y: 04

- 6 Press [SET].

TIME: 12 : 00AM

- 7 Enter the current hour/minute by selecting 2 digits for each. Press [*] repeatedly to select "AM" or "PM".

Example: 3:15PM (12 hour clock entry only)

1. Press [0][3][1][5].

TIME: 03 : 15AM

2. Press [*] repeatedly to display "PM".

TIME: 03 : 15PM

- 8 Press [SET].

- The next feature will be displayed.

- 9 Press [MENU] to exit.

Note:

- The other party's fax machine will print the date and time on each page you send according to your unit's date and time setting.
- The accuracy of the clock is approximately ±60 seconds a month.

To correct a mistake

Press [◀] or [▶] to move the cursor to the incorrect number, and make the correction.

3.5 Your logo

The logo can be your name or the name of your company.

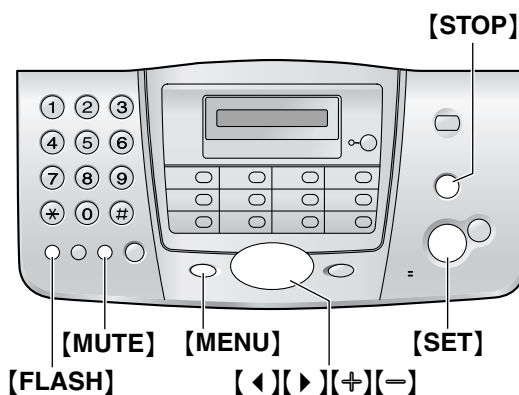

1 Press [MENU].

SYSTEM SET UP

2 Press [SET].

PRESS [◀▶] & [SET]

3 Press [◀] or [▶] repeatedly to display the following.

YOUR LOGO

4 Press [SET].

- The underbar shows the position of the cursor.

LOGO=_

5 Enter your logo, up to 30 characters. See the following character table for details.

6 Press [SET].

- The next feature will be displayed.

7 Press [MENU] to exit.

Note:

- Your logo will be printed on each page sent from your unit.

To enter characters with the dial keypad

| Keys | Characters |
|------|------------------------------------|
| [1] | 1 [] { } + - / = , . _ ` : ; ? |
| [2] | A B C a b c 2 |
| [3] | D E F d e f 3 |

3. Preparation

| Keys | Characters |
|---------|---------------------------------------|
| [4] | G H I g h i 4 |
| [5] | J K L j k l 5 |
| [6] | M N O m n o 6 |
| [7] | P Q R S p q r s 7 |
| [8] | T U V t u v 8 |
| [9] | W X Y Z w x y z 9 |
| [0] | 0 () < > ! " # \$ % & ¥ * @ ^ ' → |
| [FLASH] | To enter a hyphen. |
| [MUTE] | To insert a space. |
| [STOP] | To delete a digit. |

Note:

- To enter another character located on the same number key, press [▶] to move the cursor to the next space.

To enter your logo

Example: "BILL"

1. Press [2] 2 times.

LOGO=B

2. Press [4] 3 times.

LOGO=BII

3. Press [5] 3 times.

LOGO=BILL

4. Press [▶] to move the cursor to the next space and press [5] 3 times.

LOGO=BILLL

To correct a mistake

Press [◀] or [▶] to move the cursor to the incorrect character, and make the correction.

To delete a character

Press [◀] or [▶] to move the cursor to the character you want to delete and press [STOP].

- To erase all of the characters, press and hold [STOP].

To insert a character

1. Press [◀] or [▶] to move the cursor to the position to the right of where you want to insert the character.

2. Press [MUTE] to insert a space and enter the character.

To select characters using [+] or [-]

Instead of pressing the dial keys, you can select characters using [+] or [-].

1. Press [+] repeatedly to display the desired character. Characters will be displayed in the following order:
 - ① Uppercase letters
 - ② Number
 - ③ Symbol
 - ④ Lowercase letters
 - If you press [-], the order will be reversed.
2. Press [▶] to insert the character.
3. Return to step 1 to enter the next character.

3.6 Your fax number

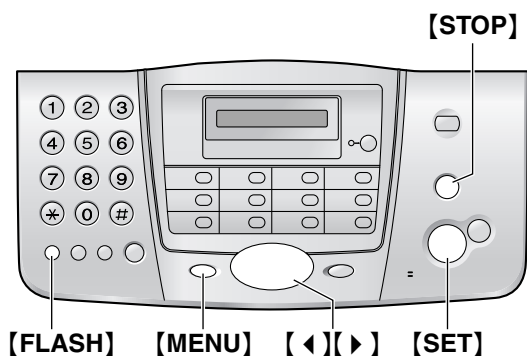

To delete a number

Press [◀] or [▶] to move the cursor to the number you want to delete and press [STOP].

- To erase all of the numbers, press and hold [STOP].

- 1 Press [MENU].

SYSTEM SET UP

- 2 Press [SET].

PRESS [◀▶] & [SET]

- 3 Press [◀] or [▶] repeatedly to display the following.

YOUR FAX NO.

- 4 Press [SET].

- The underbar shows the position of the cursor.

NO. = _

- 5 Enter your fax number, up to 20 digits.

Example: NO. = 1234567_

- 6 Press [SET].

- The next feature will be displayed.

- 7 Press [MENU] to exit.

Note:

- Your fax number will be printed on each page sent from your unit.
- The [*] button enters a "+" and the [#] button enters a space.

Example: +234 5678

Press [*][2][3][4][#][5][6][7][8].

- To enter a hyphen in a telephone number, press [FLASH].

To correct a mistake

Press [◀] or [▶] to move the cursor to the incorrect number, and make the correction.

4.1 Storing names and telephone numbers for the one-touch dial feature and navigator directory

For rapid access to frequently dialled numbers, the unit provides the one-touch dial feature (22 items) and navigator directory (100 items).

- You can also send faxes using the one-touch dial feature and navigator directory (page 28).

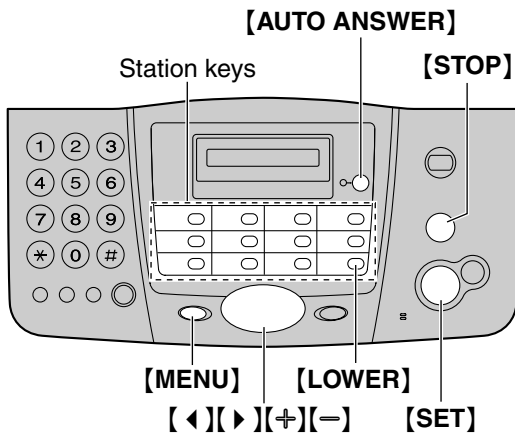

4.1.1 Storing one-touch dial items

- 1 Press **[MENU]** repeatedly to display "STATION KEY".
- 2 Press **[SET]**.
- 3 Select the desired station key.

For station 1:
(KX-FT902)

Press station 1.

(KX-FT904/KX-FT908)

Press station 1, then press **[SET]**.

For stations 2–11:

Press one of the station keys.

For stations 12–22:

Press **[LOWER]**, then press one of the station keys.

- 4 Enter the name, up to 10 characters (see page 15 for instructions).
- 5 Press **[SET]**.
- 6 Enter the telephone number, up to 30 digits.

- 7 Press **[SET]**.
 - To program other items, repeat steps 3 to 7.
- 8 Press **[MENU]**.

Helpful hints:

- You can confirm the stored items on the display (page 20) or by printing the telephone number list (page 60).

Note:

- A hyphen or a space entered in a telephone number counts as 2 digits.

To correct a mistake

Press **[<]** or **[>]** to move the cursor to the incorrect character/number, and then make the correction.

To delete a character/number

Press **[<]** or **[>]** to move the cursor to the character/number you want to delete, and press **[STOP]**.

- To erase all of the characters/numbers, press and hold **[STOP]**.

4.1.2 Storing navigator directory items

- 1 Press **[MENU]** repeatedly to display "DIRECTORY SET".
- 2 Press **[SET]**.
- 3 Enter the name, up to 10 characters (see page 15 for instructions).
- 4 Press **[SET]**.
- 5 Enter the telephone number, up to 30 digits.
- 6 Press **[SET]**.
 - To program other items, repeat steps 3 to 6.
- 7 Press **[MENU]**.

Helpful hints:

- You can confirm the stored items on the display (page 20) or by printing the telephone number list (page 60).

Note:

- If "SPACE= 5 DIRS ." is displayed, you can store only 5 more items.
- A hyphen or a space entered in a telephone number counts as 2 digits.

To correct a mistake

Press [◀] or [▶] to move the cursor to the incorrect character/number, and then make the correction.

To delete a character/number

Press [◀] or [▶] to move the cursor to the character/number you want to delete, and press [STOP].

- To erase all of the characters/numbers, press and hold [STOP].

To keep the telephone number secret

Press [AUTO ANSWER] after entering the telephone number in the navigator directory (step 5 on page 18).

- A secret number cannot be viewed after it is stored.
- The telephone number will not appear in the telephone number list (page 60).
- This feature is not available when storing a telephone number for the one-touch dial feature.

4.1.3 Editing a stored item

- 1 Press [▶].
- 2 Press [⊕] or [⊖] repeatedly to display the desired item.
- 3 Press [MENU].
- 4 Press [✖].
 - If you do not need to edit the name, skip to step 6.
- 5 Edit the name. For further details, see the storing procedure on page 18.
- 6 Press [SET].
 - If you do not need to edit the telephone number, skip to step 8.
- 7 Edit the telephone number. For further details, see the storing procedure on page 18.
- 8 Press [SET].

4.1.4 Erasing a stored item

- 1 Press [▶].
- 2 Press [⊕] or [⊖] repeatedly to display the desired item.
- 3 Press [MENU].
- 4 Press [⊡].

- To cancel erasing, press [STOP] 2 times.

- 5 Press [SET].

4.2 Making phone calls using the one-touch dial feature and navigator directory

Before using this feature, store the desired names and telephone numbers for the one-touch dial feature and navigator directory (page 18).

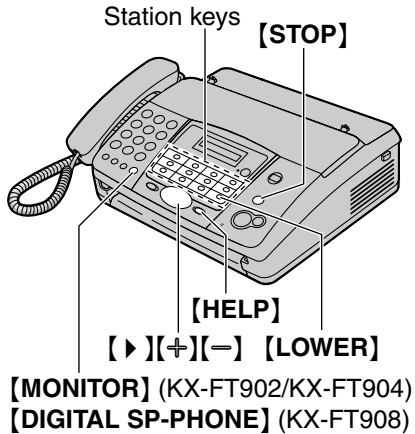

4.2.1 Using the one-touch dial feature

1 Press **[MONITOR]** (KX-FT902/KX-FT904)/**[DIGITAL SP-PHONE]** (KX-FT908) or lift the handset.

2 Select the desired station key.

For stations 1–11:

Press the desired station key.

For stations 12–22:

Press **[LOWER]**, then press the desired station key.

- The unit will start dialling automatically.

4.2.2 Using the navigator directory

1 Press **[>]**.

2 Press **[+]** or **[-]** repeatedly to display the desired item.

3 Press **[MONITOR]** (KX-FT902/KX-FT904)/**[DIGITAL SP-PHONE]** (KX-FT908) or lift the handset.

- The unit will start dialling automatically.

To confirm the stored telephone number on the display

1. Press **[>]**.
2. Press **[+]** or **[-]** until the desired name is displayed.
3. Press **[HELP]**.
 - To stop the operation, press **[STOP]**.
 - To make a call, press **[MONITOR]** (KX-FT902/KX-FT904)/**[DIGITAL SP-PHONE]** (KX-FT908) or lift the handset.

To search for a name by initial

Example: "LISA"

1. Press **[>]**.
2. Press **[+]** or **[-]** to initiate the navigator directory.
3. Press **[5]** repeatedly to display any name with the initial "L" (see the character table, page 15).
 - To search for symbols (not letters or numbers), press **[*]**.
4. Press **[-]** repeatedly to display "LISA".
 - To stop the search, press **[STOP]**.
 - To dial the displayed party, press **[MONITOR]** (KX-FT902/KX-FT904)/**[DIGITAL SP-PHONE]** (KX-FT908) or lift the handset.

Free Manuals Download Website

<http://myh66.com>

<http://usermanuals.us>

<http://www.somanuals.com>

<http://www.4manuals.cc>

<http://www.manual-lib.com>

<http://www.404manual.com>

<http://www.luxmanual.com>

<http://aubethermostatmanual.com>

Golf course search by state

<http://golfingnear.com>

Email search by domain

<http://emailbydomain.com>

Auto manuals search

<http://auto.somanuals.com>

TV manuals search

<http://tv.somanuals.com>